



Uploaded to the VFC Website

▶▶▶ 2015 ◀◀◀

This Document has been provided to you courtesy of Veterans-For-Change!

Feel free to pass to any veteran who might be able to use this information!

For thousands more files like this and hundreds of links to useful information, and hundreds of "Frequently Asked Questions, please go to:

[Veterans-For-Change](#)

If Veterans don't help Veterans, who will?

Note:

VFC is not liable for source information in this document, it is merely provided as a courtesy to our members & subscribers.



DECLASSIFIED



KT117.0413 200
26 Jul 68 - Jun 72

PROJECT

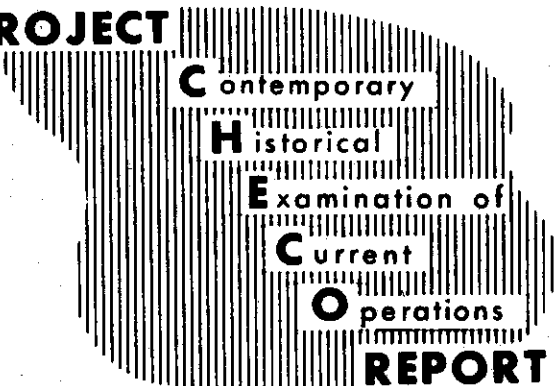

REPORT

BASE DEFENSE IN THAILAND

18 FEB 73

APPROVED FOR
PUBLIC RELEASE

HQ PACAF

**Directorate of Operations Analysis
CHECO / CORONA HARVEST DIVISION**

~~SPECIAL HANDLING REQUIRED
NOT RELEASABLE TO
FOREIGN NATIONALS
The information contained in
this document will not be
disclosed to foreign nationals
or their representatives~~

Prepared by:
**MAJ BARNETTE
CAPT BARROW
18 FEB 73
Project CHECO 7th AF, CDC**



DECLASSIFIED

Report Documentation Page

Form Approved
OMB No. 0704-0188

Public reporting burden for the collection of information is estimated to average 1 hour per response, including the time for reviewing instructions, searching existing data sources, gathering and maintaining the data needed, and completing and reviewing the collection of information. Send comments regarding this burden estimate or any other aspect of this collection of information, including suggestions for reducing this burden, to Washington Headquarters Services, Directorate for Information Operations and Reports, 1215 Jefferson Davis Highway, Suite 1204, Arlington VA 22202-4302. Respondents should be aware that notwithstanding any other provision of law, no person shall be subject to a penalty for failing to comply with a collection of information if it does not display a currently valid OMB control number.

| | | | | | |
|---|------------------------------------|-------------------------------------|--|--|---------------------------------|
| 1. REPORT DATE FEB 1973 | | 2. REPORT TYPE N/A | | 3. DATES COVERED - | |
| 4. TITLE AND SUBTITLE Base Defense In Thailand | | | | 5a. CONTRACT NUMBER | |
| | | | | 5b. GRANT NUMBER | |
| | | | | 5c. PROGRAM ELEMENT NUMBER | |
| 6. AUTHOR(S) | | | | 5d. PROJECT NUMBER | |
| | | | | 5e. TASK NUMBER | |
| | | | | 5f. WORK UNIT NUMBER | |
| 7. PERFORMING ORGANIZATION NAME(S) AND ADDRESS(ES) HQ PACAF Directorate of Operations Analysis CHECO Division | | | | 8. PERFORMING ORGANIZATION REPORT NUMBER | |
| 9. SPONSORING/MONITORING AGENCY NAME(S) AND ADDRESS(ES) | | | | 10. SPONSOR/MONITOR'S ACRONYM(S) | |
| | | | | 11. SPONSOR/MONITOR'S REPORT NUMBER(S) | |
| 12. DISTRIBUTION/AVAILABILITY STATEMENT Approved for public release, distribution unlimited | | | | | |
| 13. SUPPLEMENTARY NOTES | | | | | |
| 14. ABSTRACT | | | | | |
| 15. SUBJECT TERMS | | | | | |
| 16. SECURITY CLASSIFICATION OF: | | | 17. LIMITATION OF ABSTRACT SAR | 18. NUMBER OF PAGES 128 | 19a. NAME OF RESPONSIBLE PERSON |
| a. REPORT unclassified | b. ABSTRACT unclassified | c. THIS PAGE unclassified | | | |

RECEIVED - NOV 11 1949

NOV 11 1949

RECEIVED - NOV 11 1949

NOV 11 1949

RECEIVED - NOV 11 1949

RECEIVED - NOV 11 1949

RECEIVED - NOV 11 1949

RECEIVED - NOV 11 1949



UNCLASSIFIED

DEPARTMENT OF THE AIR FORCE
HEADQUARTERS PACIFIC AIR FORCES
APO SAN FRANCISCO 96553



PROJECT CHECO REPORTS

The counterinsurgency and unconventional warfare environment of Southeast Asia has resulted in USAF airpower being employed to meet a multitude of requirements. These varied applications have involved the full spectrum of USAF aerospace vehicles, support equipment, and manpower. As a result, operational data and experiences have accumulated which should be collected, documented, and analyzed for current and future impact upon USAF policies, concepts, and doctrine.

Fortunately, the value of collecting and documenting our SEA experiences was recognized at an early date. In 1962, Hq USAF directed CINCPACAF to establish an activity which would provide timely and analytical studies of USAF combat operations in SEA and would be primarily responsive to Air Staff requirements and direction.

Project CHECO, an acronym for Contemporary Historical Examination of Current Operations, was established to meet the Air Staff directive. Managed by Hq PACAF, with elements in Southeast Asia, Project CHECO provides a scholarly "on-going" historical examination, documentation, and reporting on USAF policies, concepts, and doctrine in PACOM. This CHECO report is part of the overall documentation and examination which is being accomplished. It is an authentic source for an assessment of the effectiveness of USAF airpower in PACOM when used in proper context. The reader must view the study in relation to the events and circumstances at the time of its preparation--recognizing that it was prepared on a contemporary basis which restricted perspective and that the author's research was limited to records available within his local headquarters area.

Robert E. Hiller

ROBERT E. HILLER
Director of Operations Analysis
DCS/Operations

UNCLASSIFIED

9. 11. 1951

1. 11. 1951

2. 11. 1951

3. 11. 1951

4. 11. 1951

5. 11. 1951

6. 11. 1951

7. 11. 1951

8. 11. 1951

9. 11. 1951

10. 11. 1951

11. 11. 1951

12. 11. 1951

13. 11. 1951

14. 11. 1951

15. 11. 1951

16. 11. 1951

17. 11. 1951

18. 11. 1951

19. 11. 1951

20. 11. 1951

21. 11. 1951

22. 11. 1951

23. 11. 1951

24. 11. 1951

25. 11. 1951

26. 11. 1951

27. 11. 1951

28. 11. 1951

29. 11. 1951

30. 11. 1951

~~SECRET NOFORN~~

DEPARTMENT OF THE AIR FORCE
HEADQUARTERS PACIFIC AIR FORCES
APO SAN FRANCISCO 96553



REPLY TO
ATTN OF DOAD

18 February 1973

SUBJECT Project CHECO Report, "Base Defense in Thailand"

TO SEE DISTRIBUTION PAGE

1. Attached is a SECRET NOFORN document. It shall be transported, stored, safeguarded, and accounted for in accordance with applicable security directives. SPECIAL HANDLING REQUIRED, NOT RELEASABLE TO FOREIGN NATIONALS. The information contained in this document will not be disclosed to foreign nationals or their representatives. Retain or destroy in accordance with AFR 205-1. Do not return.

2. This letter does not contain classified information and may be declassified if attachment is removed from it.

FOR THE COMMANDER IN CHIEF

Alfred A. Picinich

ALFRED A. PICINICH, Colonel, USAF
Chief, CHECO/CORONA HARVEST Division
Directorate of Operations Analysis
DCS/Operations

1 Atch
Proj CHECO Rprt, (S/NF),
18 Feb 73

~~SECRET NOFORN~~

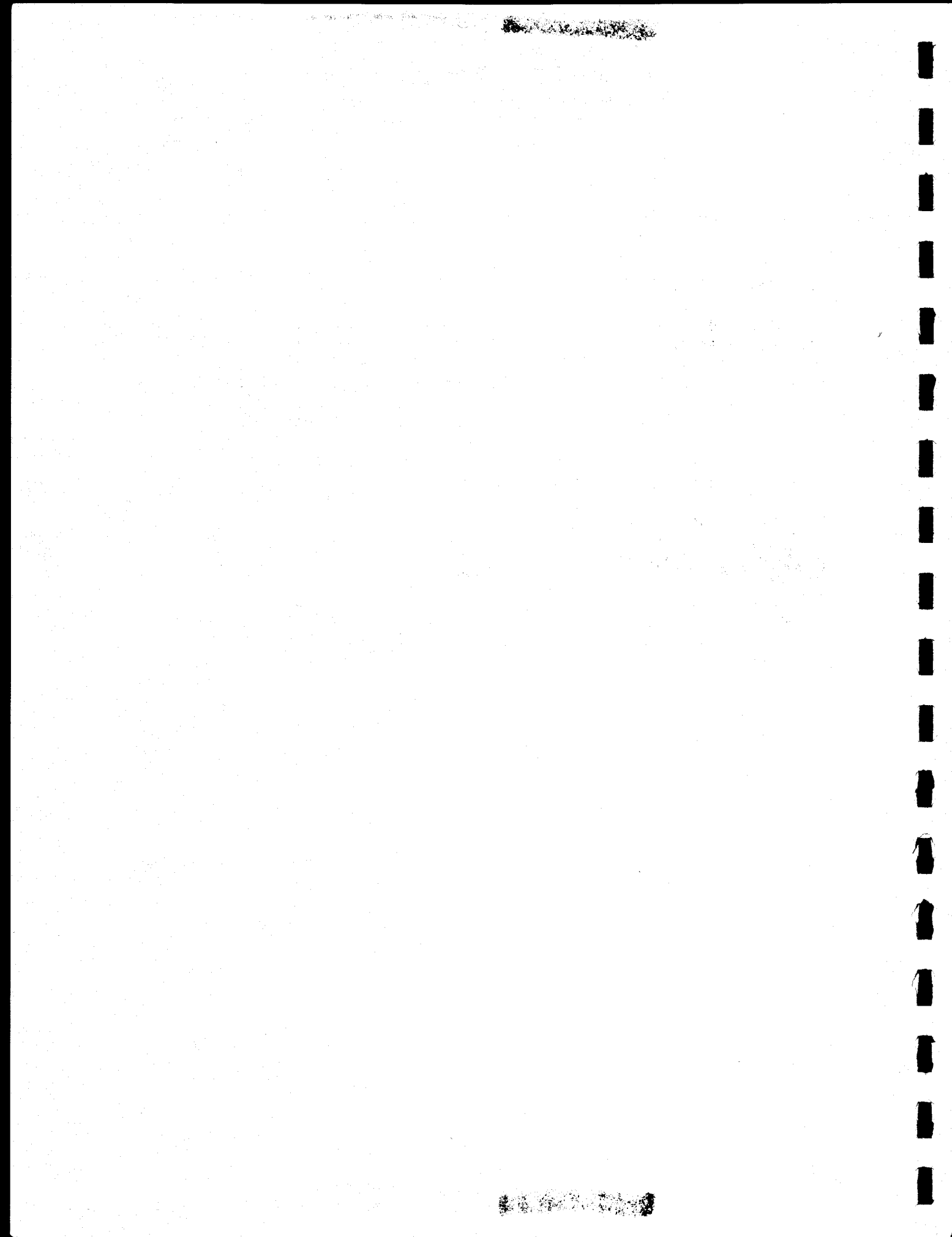

UNCLASSIFIED

DISTRIBUTION LIST

| | |
|-------------------------------|---------------------------|
| 1. SECRETARY OF THE AIR FORCE | i. AFRD |
| a. SAFAA 1 | (1) AFRDP 1 |
| b. SAFLL 1 | (2) AFRDQ 1 |
| c. SAFOI 2 | (3) AFRDQPC 1 |
| d. SAFUS 1 | (4) AFRDR 1 |
| | (5) AFRDQL 1 |
| 2. HEADQUARTERS USAF | j. AFSDC |
| a. AFNB 1 | (1) AFLGX 1 |
| b. AFCCS | (2) AFLGM 1 |
| (1) AFCCN 1 | (3) AFLGF 1 |
| (2) AFCVC 1 | (4) AFLGS 1 |
| (3) AFCHOS 2 | (5) AFLGT 1 |
| c. AFCSA | k. AFXO 1 |
| (1) AF/SAG 1 | (1) AFXOD 1 |
| (2) AF/SAMI 1 | (2) AFXODC 1 |
| d. AFIGO | (3) AFXODD 1 |
| (1) AFOSI/IVOA . . . 3 | (4) AFXODL 1 |
| (2) IGS 1 | (5) AFXOOG 1 |
| e. AFIS/INTC 5 | (6) AFXOSL 1 |
| f. AFACMI 1 | (7) AFXOV 1 |
| g. AFODC | (8) AFXOOSN 1 |
| (1) AFPRC 1 | (9) AFXOOSO 1 |
| (2) AFPRE 1 | (10) AFXOOSS 1 |
| (3) AFPRM 1 | (11) AFXOOSV 1 |
| h. AFPDC | (12) AFXOOSR 1 |
| (1) AFDPW 1 | (13) AFXOOSW 1 |
| | (14) AFXOOSZ 1 |
| | (15) AF/XOXAA 6 |
| | (16) AFXOXXG 1 |

UNCLASSIFIED

3. MAJOR COMMAND

a. TAC

(1) HEADQUARTERS

(a) XPSY 1
(b) DOC 1
(c) DREA 1
(d) IN 1

(2) AIR FORCES

(a) 12AF
1. DOO 1
2. IN 1
(b) T9AF(IN) 1
(c) USAFSOF(DO) 1

(3) WINGS

(a) 1SOW(DOI) 1
(b) 23TFW(DOI) 1
(c) 27TRW(DOI) 1
(d) 33TFW(DOI) 1
(e) 35TFW(DOI) 1
(f) 347TRW(DOI) 1
(g) 67TRW(DOI) 1
(h) 316TAW(DOX) 1
(i) 317TFW(DOI) 1
(j) 474TFW(DOI) 1
(k) 463TAW(DOX) 1
(l) 58TAC FTR TNG WG 1
(m) 354TFW(DOI) 1
(n) 314TAW(DOI) 1
(o) 4410SOTG(DOI) 1

(4) TAC CENTERS, SCHOOLS

(a) USAFTAWC(IN) 1
(b) USAFTFWC(DR) 1
(c) USAFAGOS(EDA) 1

b. SAC

(1) HEADQUARTERS

(a) DOX 1
(b) XPX 1
(c) LG 1
(d) IN 1
(e) NR 1
(f) HO 1

(2) AIR FORCES

(a) 2AF(IN) 1
(b) 8AF(DOA) 2
(c) 15AF(INCE) 1

c. MAC

(1) HEADQUARTERS

(a) DOI 1
(b) DOO 1
(c) CSEH 1
(d) MACOA 1
(e) 60MANG(DOI) 1

(2) MAC SERVICES

(a) ARRS(XP) 1

d. ADC

(1) HEADQUARTERS

(a) DO 1
(b) DOT 1
(c) XPC 1

(2) AIR DIVISIONS

(a) 25AD(DOI) 1
(b) 20AD(DOI) 1

e. ATC

(1) DOSPI 1

UNCLASSIFIED

f. AFSC

| | |
|---------------------------|---|
| (1) HEADQUARTERS | |
| (a) XRP | 1 |
| (b) SDA | 1 |
| (c) HO | 1 |
| (d) ASD(RWST) | 1 |
| (e) RADC(DOT) | 1 |
| (f) ADTC(CCN) | 1 |
| (g) ADTC(DLOSL) | 1 |
| (h) ESD(YWA) | 1 |
| (i) AFATL (DL) | 1 |
| (j) ESD(XYL) | 1 |

(2) AIR FORCES

| | |
|-----------------------------|---|
| (a) 5AF | |
| 1. CSH | 1 |
| 2. XP | 1 |
| 3. DO | 1 |
| (b) T3AF(CSH) | 1 |
| (c) 7/13AF(CHECO) | 2 |

(3) AIR DIVISIONS

| | |
|--------------------------|---|
| (a) 313AD(DOI) | 1 |
| (b) 314AD(XP) | 1 |
| (c) 327AD(IN) | 1 |

g. USAFSS

| | |
|--------------------------|---|
| (1) HEADQUARTERS | |
| (a) AFSCC(SUR) | 2 |

h. USAFSO

| | |
|-------------------|---|
| (1) HEADQUARTERS | |
| (a) CSH | 1 |

i. PACAF

| | |
|--------------------|---|
| (1) HEADQUARTERS | |
| (a) DP | 1 |
| (b) IN | 1 |
| (c) XP | 2 |
| (d) CSH | 1 |
| (e) DC | 1 |
| (f) LG | 1 |
| (g) DOAD | 6 |

UNCLASSIFIED

- (4) WINGS
 - (a) 8TFW(DOED) 1
 - (b) 56SOW(WHD) 1
 - (c) 6280CSG(DO) 1
 - (d) 388TFW(DO) 1
 - (e) 405TFW(DOI) 1
 - (f) 432TRW(DOI) 1
 - (g) 1st Test Sq(DA) 1

j. USAFE

- (1) HEADQUARTERS
 - (a) DOA 1
 - (b) DOLO 1
 - (c) DOO 1
 - (d) XP 1
- (2) AIR FORCES
 - (a) 3AF(DO) 1
 - (b) 16AF(DO) 1
- (3) WINGS
 - (a) 50TFW(DOA) 1
 - (b) 20TFW(DOI) 1
 - (c) 401TFW(DCOI) 1
 - (d) 513TAW(DOI) 1

- 4. SEPARATE OPERATING AGENCIES
 - a. DMAAC/PR 2
 - b. AFRES(XP) 2
 - c. 3825 Acad Svs Gp
 - 1. ACSC-DAA 1
 - 2. AUL/LSE-69-108 2
 - 3. HOA 2
 - d. ANALYTIC SERVICES, INC . 1
 - e. AFAG(THAILAND) 1

UNCLASSIFIED

5. MILITARY DEPARTMENTS, UNIFIED AND SPECIFIED COMMANDS, AND JOINT STAFFS

| | | |
|----|---|---|
| a. | COMUSJAPAN/J3 | 1 |
| b. | CINCPAC (J301) | 2 |
| c. | CINCPACFLT (Code 332) | 1 |
| d. | COMUSKOREA (ATTN: J-3) | 1 |
| e. | COMUSMACTHAI/MACTJ3 | 1 |
| f. | COMUSTDC (J3) | 1 |
| g. | USCINCEUR (ECJB) | 1 |
| h. | CINCLANT (CL) | 1 |
| i. | CHIEF, NAVAL OPERATIONS | 1 |
| j. | COMMANDANT, MARINE CORPS (ABQ) | 1 |
| k. | CINCONAD (COOP) | 1 |
| l. | DEPARTMENT OF THE ARMY (ASM-D) | 1 |
| m. | JOINT CHIEFS OF STAFF (J3RR&A) | 1 |
| n. | JSTPS | 1 |
| o. | SECRETARY OF DEFENSE (OASD/SA) | 1 |
| p. | CINCSTRIKE (STS) | 1 |
| q. | CINCAL (J2) | 1 |
| r. | MAAG-CHINA (MGOT-LA) | 1 |
| s. | U.S. DOCUMENTS OFFICE, HQ ALLIED FORCES NORTHERN EUROPE | 1 |

6. SCHOOLS

| | | |
|----|--|---|
| a. | Senior USAF Representative, National War College | 1 |
| b. | Senior USAF Representative, Armed Forces Staff College | 1 |
| c. | Senior USAF Rep, Industrial College of the Armed Forces | 1 |
| d. | Senior USAF Representative, Naval Amphibious School | 1 |
| e. | Senior USAF Rep, U.S. Marine Corps Education Center | 1 |
| f. | Senior USAF Representative, U.S. Naval War College | 1 |
| g. | Senior USAF Representative, U.S. Army War College | 1 |
| h. | Senior USAF Rep, U.S. Army C&G Staff College | 1 |
| i. | Senior USAF Representative, U.S. Army Infantry School | 1 |
| j. | Senior USAF Rep, USA JFK Cen for Mil Asst | 1 |
| k. | Senior USAF Representative, U.S. Army Field Artillery School | 1 |
| l. | Senior USAF Representative, U.S. Liaison Office | 1 |
| m. | Senior USAF Rep, U.S. Army Armor School, Comd and Staff Dept | 1 |

7. SPECIAL

| | | |
|----|----------------------|---|
| a. | The RAND Corporation | 1 |
|----|----------------------|---|

1950

1951

1952

1953

1954

1955

1956

1957

1958

1959

1960

1961

1962

1963



UNCLASSIFIED

TABLE OF CONTENTS

| | <u>Page</u> |
|---|-------------|
| LIST OF ILLUSTRATIONS | xi |
| A NOTE ABOUT THE AUTHORSHIP | xii |
| FOREWORD | xiii |
| CHAPTER I. THE THREAT | 1 |
| Introduction | 1 |
| Background of USAF Presence in Thailand | 1 |
| Background of Communist Activity in Thailand | 3 |
| Attacks on USAF Resources | 5 |
| Udorn 1968 Attack | 5 |
| Ubon 1969 Attack | 6 |
| Ubon 1970 Attack | 9 |
| U-Tapao 1972 Attack | 10 |
| Ubon 1972 Attack | 13 |
| Threat Estimate, Jan-Jun 1972 | 14 |
| CHAPTER II. BASE DEFENSE PERSONNEL AND PROGRAMS | 18 |
| Introduction | 18 |
| Available Defense Forces | 18 |
| USAF Security Police | 18 |
| Thai Security Guards | 19 |
| Sentry Dog (K-9) Teams | 21 |
| Royal Thai Government Forces | 23 |
| Civic Action Programs | 26 |
| Contingency Forces | 27 |
| Limitations | 30 |
| Headroom | 30 |
| Entry Control | 31 |
| Rules of Engagement | 31 |
| Concept of Use | 35 |

UNCLASSIFIED

| | <u>Page</u> |
|--|-------------|
| Base Analysis | 36 |
| Korat RTAFB | 36 |
| Nakhon Phanom RTAFB | 41 |
| Takhli RTAFB | 42 |
| Ubon RTAFB | 46 |
| Udorn RTAFB | 49 |
| U-Tapao RTNAF | 52 |
| CHAPTER III. PHYSICAL DEFENSES AND LIMITATIONS | 57 |
| Introduction | 57 |
| Active and Passive Defense Measures | 57 |
| Limitations | 64 |
| Base Analysis | 68 |
| Korat RTAFB | 68 |
| Nakhon Phanom RTAFB | 69 |
| Takhli RTAFB | 70 |
| Ubon RTAFB | 72 |
| Udorn RTAFB | 73 |
| U-Tapao RTNAF | 74 |
| CHAPTER IV. CONCLUSION | 76 |
| FOOTNOTES | 79 |
| GLOSSARY | 90 |

UNCLASSIFIED

LIST OF ILLUSTRATIONS

| <u>Figure No.</u> | | <u>Page</u> |
|-------------------|---|--------------|
| 1. | The Most Effective Defense Team Yet Devised | Frontispiece |
| 2. | Thailand: Areas of Significant Communist Presence . . . | 7 |
| 3. | Thailand: Military Airfields | 8 |
| 4. | Typical One Sector Operation | 37 |
| 5. | Korat RTAFB | 38 |
| 6. | Nakhon Phanom RTAFB | 43 |
| 7. | Takhli RTAFB | 44 |
| 8. | Ubon RTAFB | 45 |
| 9. | Udorn RTAFB | 50 |
| 10. | U-Tapao RTNAF | 53 |
| 11. | Perimeter Defense System | 59 |
| 12. | Defensive Perimeter Fences | 60 |
| 13. | Nakhon Phanom RTAFB | 65 |

CONFIDENTIAL



CONFIDENTIAL

UNCLASSIFIED

A NOTE ABOUT THE AUTHORSHIP

At the time this CHECO Report was written, Captain James R. Barrow was assigned to the Faculty of the United States Air Force Academy as an Associate Professor of Law. After completing undergraduate training in Political Science at the University of Hawaii, he received his Air Force commission in 1964 as a Distinguished Military Graduate of AFROTC program. He received his legal education and a Juris Doctor Degree with Honors from the Tulane University of Louisiana in 1966. Since then he has served as Assistant Staff Judge Advocate and Staff Judge Advocate of a SEA base. His current assignment to the Department of Law at the Academy came in 1969. Captain Barrow is a Judge Advocate, a certified trial and defense counsel, and has been designated a Military Judge by the Judge Advocate General of the Air Force.

Under the TDY augmentee program to Project CHECO, officers occasionally finish the research and a draft, but are unable to complete the report due to time limitations. In this instance, Major Benjamin H. Barnette, Jr., currently a permanent member of the CHECO staff, assumed the task of putting the study in final form and of ensuring its coordination. Major Barnette is a senior navigator and a recent Distinguished Graduate of the Air Command and Staff College (ACSC), and holds a Master of Science degree in Counseling and Guidance from Troy State University. Prior to attending ACSC, Major Barnette spent several years as a navigator in the Military Airlift Command (MAC) and served in various capacities in the personnel career field, including a tour on the DCS/Personnel staff at Hq MAC.

UNCLASSIFIED

FOREWORD

This CHECO report addresses the development of USAF base defense in Thailand from the initial attack on Udorn Royal Thai Air Force Base (RTAFB) through 30 June 1972. The 26 July 1968 attack on Udorn RTAFB was the first overt, hostile action by either communist-inspired insurgent forces or military units of North Vietnam against United States Air Force personnel and resources located in the Kingdom of Thailand. Between then and 30 June 1972, small enemy sapper units made four other attempts to gain access to USAF-tenanted Royal Thai Air Force (RTAF) bases. In some of those attempts, USAF personnel were killed or injured and resources either damaged or destroyed; in others, Thai and U.S. base defense personnel successfully thwarted the attempts. In addition, base defense planners felt that realistic, effective base defense programs forestalled other action by enemy forces during the same period.

Base defense is a function of three factors: The perceived threat of hostile enemy action; the responsive actions thought necessary to effectively counter that threat; and the various political, economic and geographic constraints imposed upon those desired responses.

The threat of hostile enemy activity directed against USAF resources in Thailand is explored in Chapter I. Emphasis is given to a brief analysis of the five attacks against USAF resources at Udorn RTAFB, Ubon RTAFB, and U-Tapao Royal Thai Naval Air Field (RTNAF), as well as intelligence estimates of the threat of such activity in the first six months of 1972.

UNCLASSIFIED

UNCLASSIFIED

Subsequent chapters deal with the responses of the planners in the preparation of adequate defenses of vital resources and personnel. Chapter II explores the USAF and Royal Thai Government (RTG) forces committed to base defense and the utilization of these forces. The chapter also discusses some of the problems encountered in coordination of defense efforts between U.S. and Thai forces, as well as some of the other constraints imposed on defense planning in this area. Chapter III is concerned with the physical defenses of the bases. Detailed comparisons are made of the six major Royal Thai bases hosting tenant USAF combat operations. Special emphasis is given to the employment of various devices and tools useful in the art of base defense. Again, the constraints on the effective utilization of such devices are considered. Both Chapters II and III discuss the innovative programs developed by base defense planners in their attempts to improve base defense. Chapter IV is a statement of conclusions and an analysis of those conclusions in light of the experiences and lessons learned in air base defense in the Republic of Vietnam over the past several years.

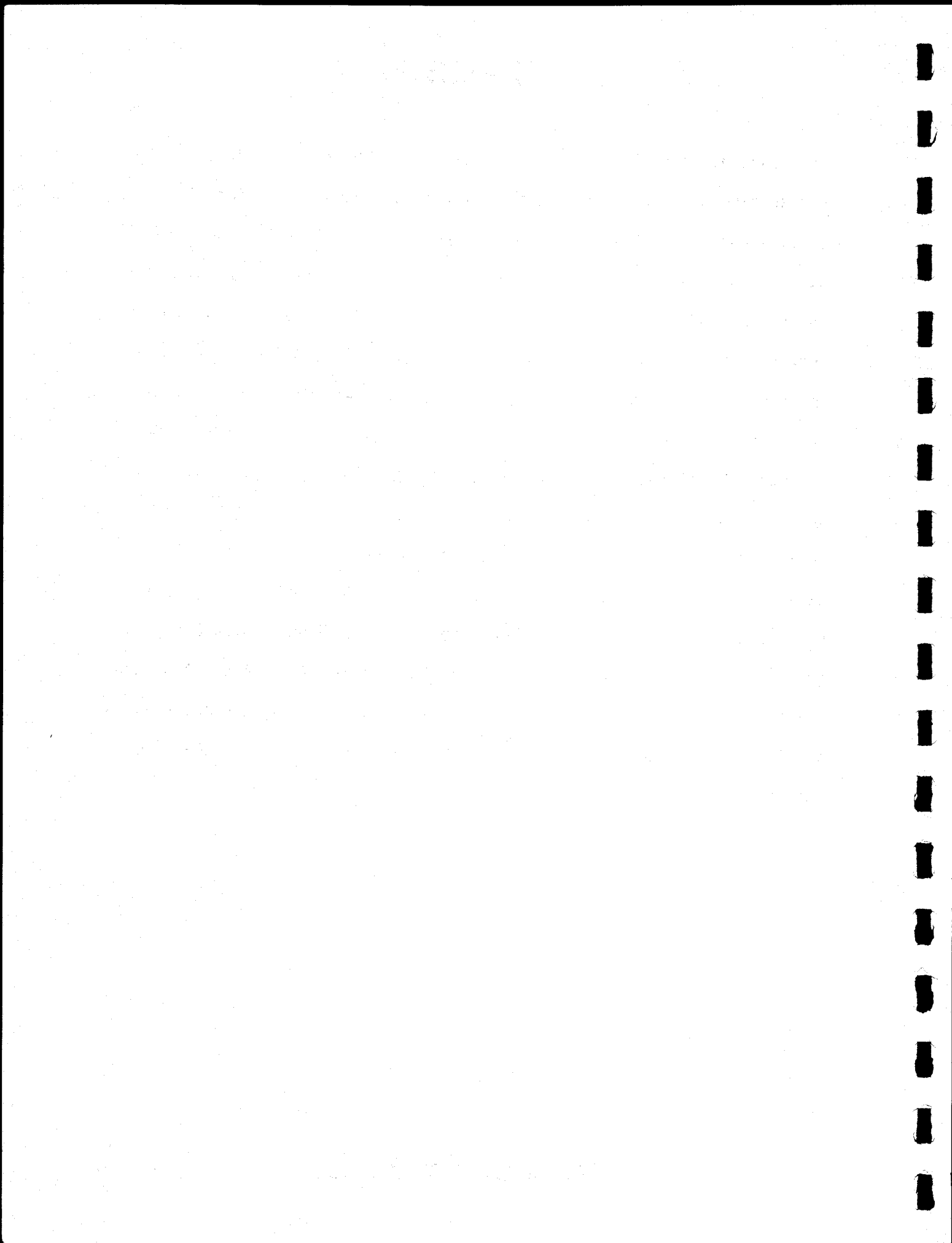

UNCLASSIFIED

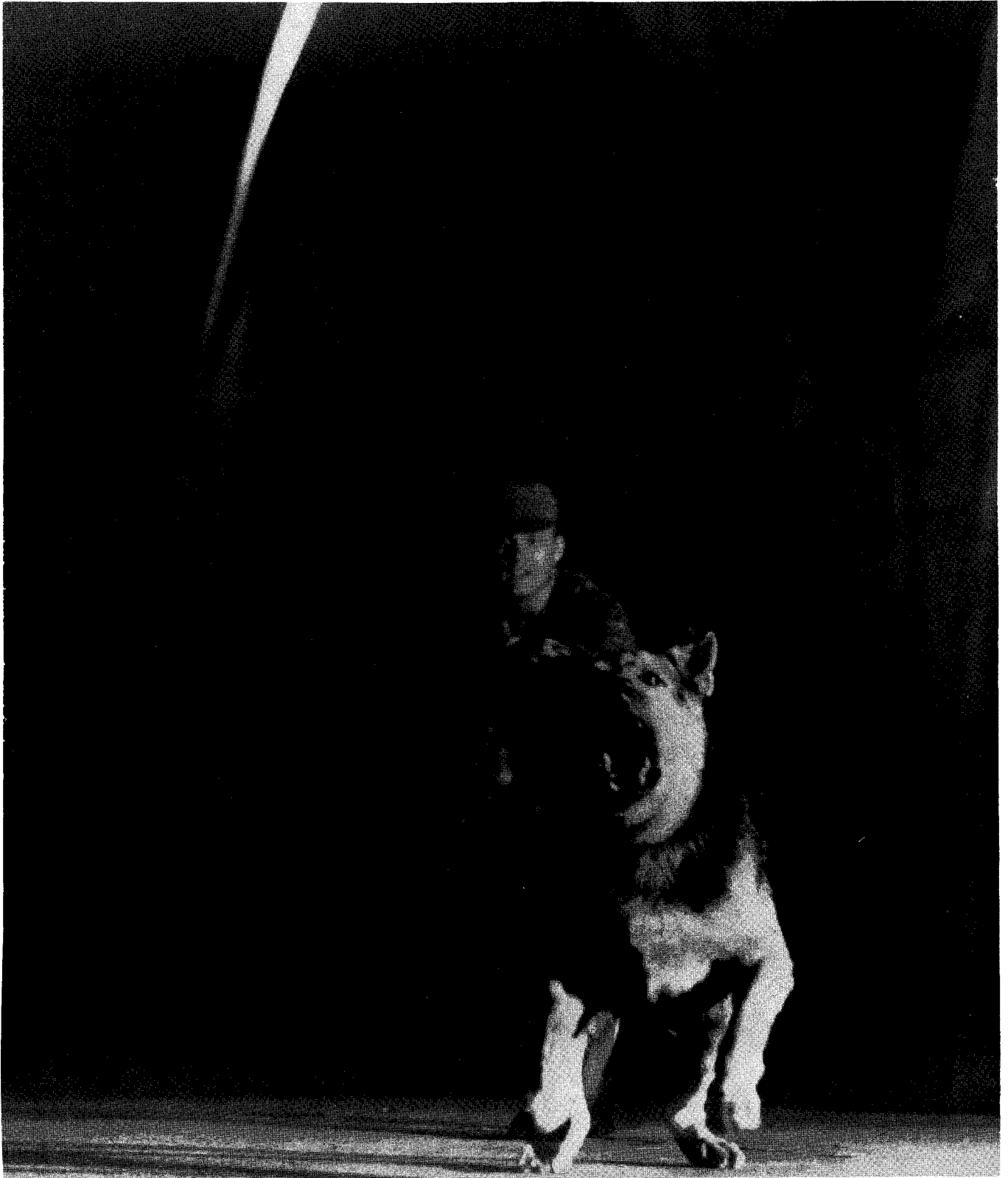

The Most Effective Defense Team Yet Devised

Frontispiece

UNCLASSIFIED

40701



~~CONFIDENTIAL~~

~~NOFORN~~

CHAPTER I

THE THREAT

Introduction

On 9 June 1972, Major General Dewitt R. Searles, the Deputy Commander, Seventh/Thirteenth Air Force (7/13AF) at Udorn Royal Thai Air Force Base, commented: ^{1/}

Shortly after my arrival in-country it was obvious that a threat to our Thailand bases existed from a communist-inspired insurgency. There were areas in full control of the insurgents and Royal Thai Government forces were not in full control of the situation. I therefore emphasized base defense.

The General also observed that: ^{2/}

The recent deployment of USAF resources to Thailand have (sic) caused threats to our bases to go up. The bulk of the United States Air Force strike force is now in Thailand. By the end of the month, 100% of this strike force will be here. This fact will not be lost on North Vietnam. There have never been more lucrative targets in all of Southeast Asia than are our Thai bases right now. Our greatest threat is trained sapper and mortar teams infiltrated from Cambodia and Laos, who, with local contacts, can be met, housed, and fed without detection until such time as they are ready to strike.

Background of USAF Presence in Thailand

Although there were a few USAF units in Thailand as early as 1961, the first significant increase of resources began in June 1964 with the deployment of the first tactical aircraft. The Gulf of Tonkin incident in August 1964 signalled the beginning of a period of significant growth.

~~CONFIDENTIAL~~

~~NOFORN~~

By the end of 1964, there were over 6,000 USAF personnel in Thailand; RTAF bases at Udorn, Takhli, Korat, Ubon and Don Muang all hosted USAF units.^{3/} At the close of 1966, nearly 26,000 personnel and 416 USAF aircraft were based in Thailand.^{4/} By December 1967, two more bases, Nakhon Phanom RTAFB and U-Tapao RTNAF, were added, bringing to 505 the number of USAF aircraft conducting operations from Thailand.^{5/} Then, in 1968, President Johnson ordered a halt to the bombing of North Vietnam. Subsequently, USAF forces in Thailand were gradually reduced. Operations ceased altogether at Takhli RTAFB, and by 1 April 1972 there were only 317 tactical aircraft in Thailand, including 42 B-52 bombers and 30 KC-135 aircraft at U-Tapao RTNAF. USAF personnel were also reduced significantly. (The USAF posture in Thailand between 1961 and 1970 has been chronicled in several CHECO reports.^{6/})

The North Vietnamese invasion of South Vietnam in 1972 resulted in the TDY deployment of additional USAF units to Thailand. By 24 May 1972, the U.S. response to the communist invasion had increased USAF forces to 537 tactical aircraft, including 52 B-52 bombers and 62 KC-135 tankers, and 29,118 personnel. Probably the most spectacular example of the deployment was at Takhli RTAFB. By 24 May Takhli RTAFB had not only been reopened to USAF units, but it held 74 F-4D fighters and 16 KC-135 tanker aircraft.^{7/} Further, U.S. Department of Defense press releases repeated in local Thai newspapers in June revealed that several, if not all, remaining USAF units then stationed in South Vietnam would soon be redeployed to Thailand.^{8/}

~~CONFIDENTIAL~~

~~SECRET~~

~~NOFORN~~

In estimating the effect that this deployment had on base defense, the Director of Security Police, 7/13AF, said:^{9/}

The threat to our resources at the Thai bases has materially increased since 1 April 1972. The build-up since then has made them more lucrative targets. The importance of these bases in the interdiction of the current offensive is not lost to the North Vietnamese.

Background of Communist Activity in Thailand

The subject of communist-inspired insurgency has been discussed in several CHECO reports.^{10/} These reports indicate that although communist efforts at developing an insurgency movement in Thailand had been underway since the close of World War II, they were not very active until the 1965 expansion of the war in South Vietnam. There had been only 16 Communist Terrorist (CT) incidents in Thailand between 1962 and 1964.^{11/} But between January and November 1966, there were 136 armed encounters between CT and RTG forces in the northeast provinces where four of the RTAF bases with USAF operations were located.^{12/} Despite considerably increased communist activity, especially in the northeastern provinces, no overt, hostile communist activities were directed against USAF resources until the 26 July 1968 attack on Udorn.

This early absence of attacks should not be interpreted as an indication of communist disinterest in USAF activities. One CHECO report noted that the communist-inspired insurgency was at least in part directly related to increased USAF operations in Thailand in support of the war in South

~~SECRET~~

~~CONFIDENTIAL~~

~~SECRET~~
~~NOFORN~~

Vietnam. ^{13/} A clandestine radio broadcast in 1968 by the communist "Voice of the People of Thailand" stated: ^{14/}

Since the Americans have invaded and occupied Thailand and used it as their base for aggression they have brought disaster to the nation and the people. U.S. soldiers have not only barbarously tramped upon the nation's sovereignty and independence, they have also caused severe hardships for the Thai people. They have debased our society. This is why people have expanded their resistance against them.

Increased U.S. presence in Thailand and U.S. participation in counter-insurgency activities further motivated communist propagandists. Several of the Rules of Engagement (ROE) which prohibited certain USAF activities related to base defense may well have sprung from a desire to minimize communist propaganda exploitation of the U.S. presence. These ROE will be discussed in subsequent chapters.

By early 1972, the number of communist-initiated encounters with RTG forces had risen alarmingly. There were 3400 such incidents in 1971 compared to 2700 in 1970. Further, estimates of CT main-force strength in the northeast alone showed an increase from between 1400 to 1600 men in 1970 to between 1525 to 1775 in 1971. ^{15/} In 1970, the RTG had designated 35 of the 76 provinces of the country as "Insurgency-Threatened Areas." These areas included every USAF installation in Thailand except Takhli and U-Tapao. ^{16/} Although the immediate, direct threat to USAF assets and personnel appeared slight, the existence of "Insurgency-Threatened Areas" did indicate the potential danger. In fact, several aircraft reported

~~CONFIDENTIAL~~

~~NOFORN~~

ground fire in areas of high communist activity and even in close proximity to the major bases. (Figures on following pages show the areas of highest concentration of communist activities and the locations of USAF operations.)

Attacks on USAF Resources

Through 30 June 1972, communist forces made five attacks on USAF resources located at three RTAF bases. The first such attack was on 26 July 1968 against Udorn RTAFB. Subsequently, Ubon RTAFB was attacked on 28 July 1969, 13 Jan 1970, and 4 June 1972, and U-Tapao RTNAF on 10 January 1972. All attacks occurred during the hours of darkness and all were conducted by small sapper units armed with a variety of explosive devices.

Udorn 1968 Attack. On 26 July 1968, at 2230 hours, a CT "Dac Tong" (sapper) unit successfully penetrated the defensive perimeter of Udorn RTAFB and, despite detection, reached and damaged some USAF aircraft, killed a Thai Security Guard (TSG), fatally wounded a USAF crew chief, and wounded two security police defenders. A C-141 aircraft and an F-4D aircraft were heavily damaged. (An in-depth analysis of this first attack was the subject of a CHECO report.^{17/})

Following this attack, the Office of Special Investigation (OSI) issued an analysis of the incident, and concluded:^{18/}

Vietnamese Communist plans and activities, a significant factor in assessing the security threat not only at Udorn but also at Nakhon Phanom and Ubon RTAFB's, appear to have been revitalized since the beginning of 1968, with greater emphasis being

placed on future joint cooperation with Thai insurgent forces. Current communist propaganda appears to show a growing emphasis on activities against the U.S. forces in Thailand and the bases from which they operate. Perhaps the most significant factor in any communist plans for future attacks on the bases will be the reaction and effectiveness of Thai Government forces in suppressing and/or punishing the participants in the first attack. The absence of any effective retaliation, other than the killing of two of the group during the attack, will likely lead to a repetition of the same type activity if presently increased security procedures have been relaxed. Based on factors discussed in the above paragraph, the relative vulnerability (given in descending order) of the air bases in Northeast Thailand to a future attack of the same type appears to be as follows: Udorn, Nakhon Phanom, Ubon and Korat. Although some installations in other regions of Thailand, such as U-Tapao Airfield, possibly offer a more desirable target than do the bases in the Northeast, available intelligence does not indicate either the presence of guerrilla units within a reasonable distance of these bases or the existence of Communist support in the villages near their perimeters. This would not preclude a possible one time strike at any of these installations by a highly trained raiding squad. Since inexperience and faulty explosive devices appear to have helped minimize the damage caused in this first attack, a repetition of the same could be vastly more destructive.

These predictions were to come true to a large extent in the next four years.

Ubon 1969 Attack. The next attack on USAF facilities came at Ubon RTAFB at 0130, 28 July 1969. A security police sentry and his dog were wounded when they detected the sappers exfiltrating the base. Half an hour later there were five explosions which damaged two C-47 aircraft and a power van. Five unexploded charges were discovered. Initially,

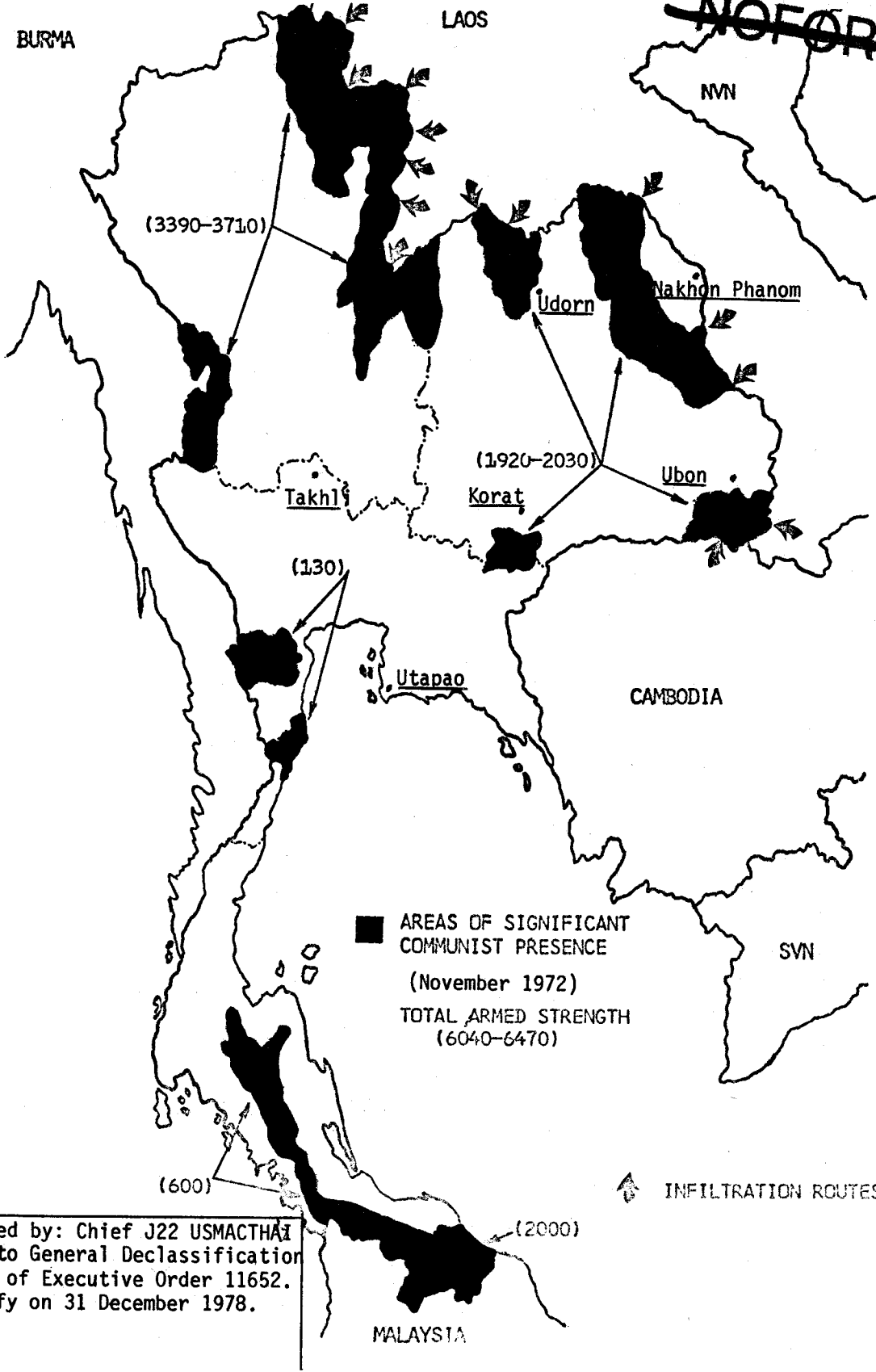

Classified by: Chief J22 USMACV/AF
 Subject to General Declassification
 Schedule of Executive Order 11652.
 Declassify on 31 December 1978.

THAILAND: Areas of Significant Communist Presence

FIGURE 2

1907
1908

1
2
3
4
5
6
7
8
9
10
11
12
13
14
15
16
17
18
19
20
21
22
23
24
25
26
27
28
29
30
31
32
33
34
35
36
37
38
39
40
41
42
43
44
45
46
47
48
49
50
51
52
53
54
55
56
57
58
59
60
61
62
63
64
65
66
67
68
69
70
71
72
73
74
75
76
77
78
79
80
81
82
83
84
85
86
87
88
89
90
91
92
93
94
95
96
97
98
99
100

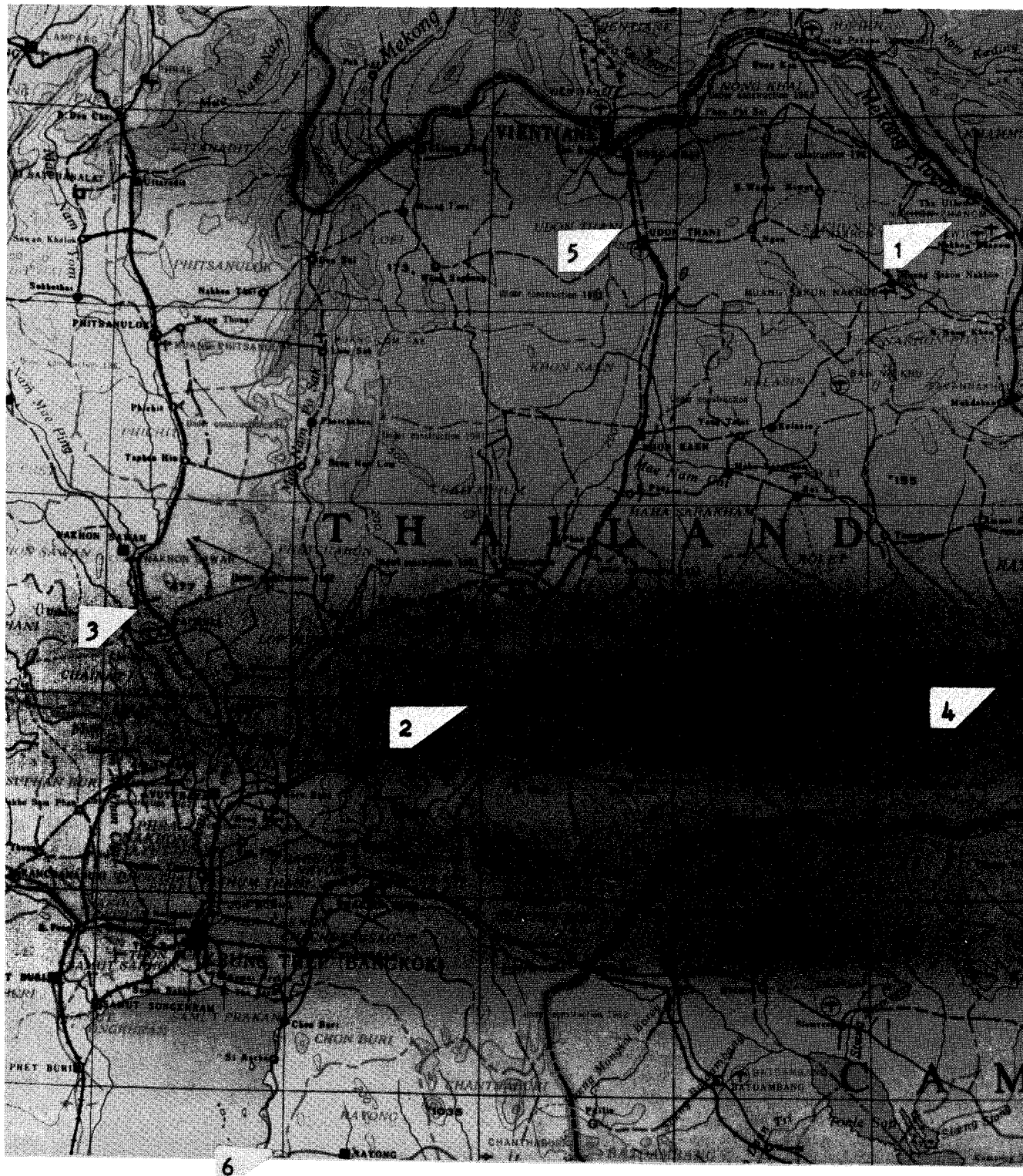

Thailand: Military Airfields

- | | |
|------------------|------------------|
| 1. Nakhon Phanom | 4. Ubon RTAFB |
| 2. Korat RTAFB | 5. Udon RTAFB |
| 3. Takhli RTAFB | 6. U-Tapao RTNAF |

FIGURE 3

1900



~~NOFORN~~

the detonations were mistakenly identified as mortar explosions. Thai police units responded to predetermined perimeter defensive positions 41 minutes after notification of the attack. The sappers, numbering an estimated three individuals, suffered no casualties and escaped. The Chief of Security Police, 8th Combat Support Group, Ubon RTAFB stated that "the successful and undetected penetration and sabotage reflected a serious need for base defense personnel to utilize available night observation equipment." Also, "perimeter vegetation control and the training, especially for the K-9 sentries, was highly deficient." The need for close coordination with local friendly forces was also emphasized.^{19/}

A significant sidelight on the attack was that the K-9 sentry-dog handler who detected the escaping sappers did not immediately fire on them or report their presence to Central Security Control (CSC) because he assumed that this was part of a scheduled exercise. He later withheld fire, even though he realized they were hostile, because "his dog was in the line of fire." By the time the sentry notified other defense forces and they were able to respond, the enemy had escaped through the perimeter wire.^{20/}

Ubon 1970 Attack. Ubon was again attacked by enemy sappers at 0201, 12 January 1970. The base was in a "Yellow Alert" posture of increased security preparedness because of a local villager's report, relayed to the base CSC by the local Thai Provincial Police (TPP), that at 2030 hours 16 armed Vietnamese were observed only three kilometers (km) from the

~~CONFIDENTIAL~~

~~SECRET~~ ~~NOFORN~~

base. At the time of the attack, 363 security personnel, including 157 TSGs, were on duty. A K-9 sentry detected the first of six enemy infiltrators shortly after the sapper had penetrated 10 yards inside the perimeter fence. Fire was exchanged and the sector security alert team (SAT) quickly responded to the scene. A 23-minute fire fight ensued in which five enemy were killed, one security policeman and one dog were wounded, and a sentry dog was killed. No USAF aircraft were damaged, although 35 satchel charges were found. Timely intelligence, excellent training, superior control, and quick response were credited with the detection and containment of the enemy. Only poor lighting and several duds in the 81mm mortar illumination rounds were cited as significant deficiencies.^{21/}

A message from the U.S. Embassy to the Department of State indicated that an analysis of this and the July 1969 attack strongly indicated that both attacks were carried out by either the same, or closely coordinated, sapper units that were specially trained and targeted by communist forces outside Thailand.^{22/} Both the Commander-in-Chief, Pacific Air Forces (CINCPACAF), and the Deputy Commander, 7/13AF, sent messages expressing congratulations and extreme satisfaction with the professional response by the base defense forces.^{23/} In the six months which had elapsed following the first attack, the security forces had become a well-trained, cohesive unit, capable of detecting and repelling such an attack.

U-Tapao 1972 Attack. Throughout 1970 and 1971, U-Tapao RTNAF was listed as having the lowest threat potential of any air base in Thailand.

~~CONFIDENTIAL~~

~~NOFORN~~

However, without any prior intelligence alert, a communist sapper unit penetrated the base perimeter without being detected, then infiltrated to within a few hundred yards of parked B-52 aircraft before they were spotted by a sentry dog patrol.

At 0222 hours, 10 January 1972, a K-9 patrol detected three sappers about 15 feet ahead when his dog "alerted." The sappers fired at him and he took cover, trying unsuccessfully to have his dog attack the sappers. One sapper evidently fled and the other two ran toward the B-52 parking ramp. They were next seen by a TSG who withheld fire "because there were B-52 aircraft in a line behind the infiltrators." Another TSG tried to fire on the sappers as they ran down the ramp, but his M-16 jammed. The sappers threw satchel charges and one Chinese-made hand grenade into three revetments. The grenade was a dud, but four charges detonated, causing minor damage to two B-52s and more substantial damage to a third. The explosions caused an estimated \$26,000 damage. One sapper tried unsuccessfully to fire a revolver at several maintenance personnel in the area. CSC dispatched SATs and Quick Reaction Teams (QRTs) to the scene. In the ensuing action, one of the enemy was wounded at the perimeter but escaped. Another was killed while attempting to exit the fenced Munitions Maintenance and Storage (MMS) area, about 100 yards from the perimeter fence. There were no USAF or Thai casualties.

Small arms fire was reported from positions off-base during the attack. RTG forces responded to the area very quickly, and a Provincial Police unit

~~CONFIDENTIAL~~

~~NOFORN~~

conducted sweeps outside the perimeter within 30 minutes of the inception of the attack. Later, RTG military units also participated in searches. The last enemy contact was at 0235. ^{24/}

Overall, the attack was considered a failure and several levels of command quickly sent commendations to the defenders. Special emphasis was given to the RTG's prompt response. ^{25/}

However, the Deputy Commander, 7/13AF, in a lengthy message to the 7AF Commander, revealed several existing deficiencies. He noted the need for a four-channel radio communication system; the lack of a joint U.S.-RTG base defense plan; and the lack of joint training exercises in the past. General Searles also commented on the "calculated risk" inherent in the use of TSGs in base defense. He also singled out the inadequate fencing and a lack of effective vegetation control as additional weaknesses. ^{26/}

Another problem was the failure of the sentry dog to close with the enemy when commanded to attack. Higher headquarters took several steps to emphasize attack training and gunfire familiarization for sentry dogs to avoid similar problems. ^{27/} Additionally, an examination of the after-action evaluations raised a series of questions: How had the three enemy agents penetrated the base perimeter undetected? How had they infiltrated so close to the bombers before they were spotted? Then, once they were identified as hostile, how did two of them still manage to go several hundred yards to the well-lit B-52 parking area, hurl explosive charges at three, supposedly well-defended aircraft, and then escape? Even the

~~CONFIDENTIAL~~

~~SECRET~~

~~NOFORN~~

sapper who was killed went several hundred yards from the ramp and penetrated the defended MMS area before he was finally stopped.

The OSI analysis of the attack concluded: ^{28/}

The relative degree of success or failure of the U-Tapao attack depends on who is making the assessment. From the communist standpoint, they infiltrated three intruders into a heavily defended U.S. position, damaged three expensive U.S. aircraft, and recovered two of the attackers. The loss of only one man, when measured against the satisfaction and propaganda value derived from such an effort, clearly marks the success of the mission. From the American side, the early detection of the intruders and their failure to significantly affect U.S. combat posture makes the attack a failure. Regardless of which viewpoint is accepted, the U-Tapao attack serves to reaffirm the contention that small groups of well trained, dedicated individuals can penetrate U.S. tenanted installations in Thailand.

Ubon 1972 Attack. On 1 June 1972, the local OSI detachment at Ubon RTAFB received "reliable" information that there were 12 Vietnamese in the immediate area of Ubon who had been previously repatriated from Thailand to North Vietnam, trained as sappers, and infiltrated back into Thailand with the specific mission of attacking USAF aircraft at Ubon RTAFB. ^{29/} At 0003 hours 4 June 1972, two RTG "liaison patrols"* returning to Ubon RTAFB on the perimeter road saw an unidentified man running about five yards inside the base perimeter fence. He was challenged by the police

*A liaison patrol was a jeep patrol operated by the Thai Provincial police that made nightly sweeps within a 16km circle around the base. It consisted of three armed policemen and one unarmed USAF security policeman who provided communications and coordination with the base CSC.

~~SECRET~~

but did not stop. Instead, he ran toward the AC-130 gunship revetments about 50 yards away. After prompting by the USAF member of the patrol, the police opened fire over the head of the intruder. Shortly thereafter, a TSG on a random post opened fire. The sapper dropped to the ground and returned fire at the police, who then shot him. Inspection of the body revealed that the sapper carried eight highly sophisticated satchel charges. During the incident, at least one other suspected sapper was detected outside another sector of the perimeter, and several sentry-dog handlers received strong "alerts" from their dogs in that area. An AC-130 on final approach was directed to drop flares in the area, but there was no further contact. No USAF or RTG personnel were injured and there was no damage to USAF facilities.^{30/} An analysis of the incident indicated that the dead sapper was carrying out an intended diversion and that the prompt reaction by defense forces and the AC-130 flareship probably prevented a more serious sapper attack.^{31/}

Threat Estimate, Jan-June 1972

During the first half of 1972, Hq 7/13AF Ground Combat Intelligence listed the overt action threat to USAF tenanted bases by enemy forces as follows: the threat of enemy reconnaissance of all bases was listed as high; the threat of large-scale mass attacks against any base was low; the threat of internal sabotage at all bases was high; and the threat of small-unit sapper attacks was high at Ubon RTAFB, moderate to high at NKP RTAFB, moderate at Udorn RTAFB and U-Tapao RTNAF, and low at Korat RTAFB and Takhli RTAFB. Additionally, the Joint United States Military

~~CONFIDENTIAL~~

~~NOFORN~~

Advisory Group, Thailand (JUSMAGTHAI), indicated that standoff Rocket/ Artillery/Mortar (RAM) attacks at some of the bases could be expected any day.^{32/}

It was conceded that the threat of hostile actions directed against USAF forces by the local CT was relatively low, with the greatest danger coming from imported, highly trained, professional sapper units from Laos and North Vietnam.^{33/} Several different sources provided proof of the real danger from military units outside Thailand. After the attack on Ubon RTAFB in June 1972, there were three encounters with remnants of that communist sapper force. One came on 5 June when Thai police had an armed encounter with them, and a second occurred on 6 June when the sappers ambushed a Royal Thai Army (RTA) unit. Both incidents occurred east of Ubon near the Laotian border.^{34/} Then, on 10 June, two squads of the Royal Laotian Army engaged this force inside Laos, killing two of its members. Identification of the enemy indicated they were regular North Vietnamese Army (NVA) personnel.^{35/}

An OSI intelligence report relayed information from a reliable source that approximately 653,750 Baht (\$31,392) in donations had been raised from Vietnamese around Ubon for the support of teams targeted against U.S. bases in Thailand. The teams were composed of Vietnamese previously repatriated from Thailand to North Vietnam, where they were specially trained.^{36/} Other OSI sources in the Nakhon Phanom RTAFB area reported that NVA officers and advisors were making frequent river crossings from Laos into the northeastern provinces of Thailand during the first half of 1972.^{37/}

The potential for a stand-off RAM attack was also proven to be within the enemy's capability. On 31 May 1972 over 100 CT, using rocket-propelled grenades (RPGs) of the B-40/RPG-2 rocket type, attacked an RTG Village Defense Corps unit near Na Kae, less than 35km from Nakhon Phanom RTAFB.^{38/} There were also confirmed reports of the use of 82mm and 60mm mortars by communist forces against RTG forces.^{39/} Additionally, heavier rockets and mortars were readily available from several communist controlled areas of Laos. Nakhon Phanom RTAFB, itself, was within range of various weapons from the communist positions across the Mekong River in Laos. On 30 June 1972, reliable information was received about the first introduction of communist 122mm rockets into Thailand from Laos, approximately 45 miles north northwest of Nakhon Phanom RTAFB.^{40/} Consequently, USAF defense planners characterized the risk of a stand-off attack "as a distinct possibility."^{41/}

A consideration of the effective ranges of the several RAM weapons known to have been used by communist forces during that time frame emphasized the magnitude of the danger.

ENEMY WEAPONRY^{42/}

| <u>Weapon</u> | <u>Range</u> |
|-------------------------|----------------|
| RPG-2 Anti-Tank Grenade | 150-180 Meters |
| RPG-7 Anti-Tank Grenade | 500 m |
| 57mm Recoilless Rifle | 4375 m |
| 75mm Recoilless Rifle | 6675 m |
| 60mm Mortar | 1790 m |
| 82mm Mortar | 3040 m |
| 120mm Mortar | 5700 m |
| 107mm Rocket | 8300 m |
| 122mm Rocket | 10,073 m |
| 140mm Rocket | 10,607 m |

~~CONFIDENTIAL~~

~~NOFORN~~

In 1972, the Hq 7/13AF Directorate of Security Police issued warnings to the six Air Force installations in Thailand of grave danger from a different quarter. Reliable intelligence reports from U.S. civilian intelligence agencies, as well as OSI sources, indicated that the Communist Party of Thailand had made plans to infiltrate three USAF bases. Enemy-controlled agents were targeted against Ubon RTAFB, Udorn RTAFB, and Nakhon Phanom RTAFB, with instructions to secure jobs as Thai employees, conceal weapons and explosive and, thus, be in a position to conduct acts of internal sabotage on the bases. Consequently, 7/13AF gave great emphasis to the need for controlling the movement of Thai nationals, especially in areas around primary USAF resources.^{43/}

Clearly, however, the focus of USAF defenses in the first six months of 1972 centered on sapper units attempting surreptitious penetration and sabotage. The two attempts of such action at U-Tapao RTNAF and Ubon RTAFB that year gave clear evidence of that threat.

Perhaps the best summary of the importance of the total threat was contained in messages from the Chairman of the Joint Chiefs of Staff and CINCPACAF:

. . . The threat is expected to increase, it could become critical with very little, if any warning.^{44/}

Due to the importance of Thai based air support, insurgent activity in Thailand is being followed very closely here [JCS] as a successful attack against these bases would have serious implications. In this regard, it is essential that all feasible actions be taken to assure the security of U.S. forces and equipment.^{45/}

CHAPTER II

BASE DEFENSE PERSONNEL AND PROGRAMS

Introduction

In direct response to the estimate discussed in the previous chapter, base defense planners developed programs to counter all facets of the threat, especially sapper penetration. This chapter includes: an examination of the base defense force; a base-by-base analysis of special problems and the programs designed to counter them; a discussion of Thai-U.S. cooperation; and the limitations imposed by the rules of engagement.

Available Defense Forces

USAF Security Police. As of June 1972, there were only 22 USAF Security Police (SP) officers and 1641 security policemen authorized for all of Thailand. Because of the deployment of USAF augmentees to Thailand in the spring of 1972, there were additional SP forces in-country on TDY. Most of these were at Takhli, which was defended solely by 368 SPs on on TDY.^{46/} Naturally, not all SPs were available for base defense. Law enforcement, drug programs, customs, and disaster control responsibilities all required the assignment of men who otherwise would have been available to detect and repel the enemy. The majority of the SPs had attended either the OZR (TSgt and above) or AZR (SSgt and below) Combat Preparedness Course. These three-week courses at Lakland AFB were mainly in weapons familiarization, with some very basic training in the concepts of base defense and light infantry tactics useful in a hostile environment. One base Chief

~~CONFIDENTIAL~~

~~NOFORN~~

of Security Police (CSP) in Thailand felt that these two courses should be expanded to include more training, especially in infantry-style tactics, in order to properly prepare SPs for the role of base defense in areas such as Vietnam and Thailand.^{47/} Most CSPs rated morale of their personnel as "good" or better, and all indicated that they had sufficient security forces available to perform their defense role. They also asserted that massive TDY deployments of machines and men had not (with the exception of Takhli, which is discussed in detail later) created any significant problems. Nor had the deployments required fundamental policy adjustments or changes. The major personnel problem experienced by most CSPs was the annual summer rotation of experienced officers and senior NCOs. In one squadron alone, the ratio of experienced NCOs (NCOs with over three months on station) fell from over 90 percent in May to less than 30 percent in June during the critical period of the deployment.*^{48/}

Thai Security Guards. In order to augment the SPs available in Thailand with well-trained, effective military forces under the operational control of base-level defense planners, the United States Government and the RTG entered into a contract on 1 February 1966. Under the terms of this agreement, the Commander, U.S. Military Assistance Command, Thailand (COMUSMACTHAI) and the Thai Government agreed that the RTG would establish a paramilitary force which would be manned by Thai military reservists and by regular Thai military officers and NCOs. Units of this force,

*All technical sergeants in the unit rotated.

known as Thai Security Guard (TSG) companies, were detailed to each USAF-tenanted Thai base. The TSGs were under the operational control of the USAF base commander, through his CSP. The U.S. had expended over \$15,000,000 under this contract through June 1971.^{49/} The function of these companies was emphasized in a memo from the Thai Supreme Commander, Air Chief Marshal Dawee, to all RTAF base commanders: "The security guarding in the allies' base *is the duty of the Thai Security Guard Regiment.*" (His emphasis.)^{50/}

During the first few years of the TSG program, difficulties were encountered, chiefly in the training of the guards and in problems of communication. USAF commanders initially showed a reluctance to fully integrate these "foreign" forces into their base defense units.^{51/} However, from the late 1960s through June 1972, special 7/13AF command emphasis on local training and total integration and utilization of forces created a highly respected, functional unit of the total base defense force.^{52/}

When properly utilized on any given base, the greatest strength of the TSG force was its flexibility. The TSG companies, as USAF "employees," were entirely under the operational control of USAF defense planners. However, the RTG attempted to implement in June 1972 a program that would have seriously jeopardized this command and control arrangement and would have gravely limited the forces' effectiveness. The Thai Supreme Command, operating through the Thai Security Guard Regiment Commander, issued Order #265/15. This order directed local TSG company commanders to implement a Supreme Command directive that all TSGs would henceforth be housed on-base

~~CONFIDENTIAL~~

~~NOFORN~~

with only one day off a week. (At the time the order was given, about 40 percent of the TSG resided off-base with their families.) Additionally, the order directed TSGs to work a four-hour-on, four-off, four-on shift, rather than the eight-on, 16-off shift then in effect.

USAF officers at operational and command levels expressed extreme concern, and because of firm opposition by the 7/13AF Deputy Commander and the Directorate of Security Police, the order remained unexecuted. (The U.S. Army had implemented the plan during the 20 days it was in effect, and, as had been predicted by USAF officials, severe morale and efficiency problems quickly became apparent.^{53/}) Thus a potential problem affecting one of the most important segments of the base defense force was precluded through prompt action by USAF and RTG authorities.

At the beginning of the USAF deployments in 1972, there were 2407 TSGs authorized and 2263 present for assignment. The total of 2263 was increased by 188 in June. Excess TSGs from the Camp Friendship training center at Korat RTAFB filled the increased manning requirements brought on by the USAF deployments.^{54/}

Sentry Dog (K-9) Teams. A specially-trained dog was a valuable adjunct to the detection ability of a human guard. Known as sentry or patrol dogs depending on their training, these canines vastly enhanced the effectiveness of perimeter guards in their vital role of detecting enemy penetration attempts. Although the attention span of dogs is limited, and is dulled

after several hours on duty, especially during inclement weather, they are nevertheless an important part of the defensive posture at U.S. installations. Perhaps the best proof of their effectiveness was the fact that in every base attack (except the one in 1972 at Ubon RTAFB) a sentry dog first alerted defense personnel of an enemy presence. Even in the 1972 Ubon RTAFB intrusion, the base commander credited a series of K-9 "alerts" on the perimeter with forestalling a major sapper attack from one quarter while a sapper created a diversion elsewhere. ^{55/}

With the exception of Takhli RTAFB, each base had an average of 50 to 60 dogs and a 60 percent SP/40 percent TSG ratio of dog handlers. At Takhli RTAFB, SPs handled all 22 dogs. Generally the dogs were German Shepherd, with sentry or patrol training at either Okinawa or Lackland, plus in-country training. The 7/13AF Director of Security Police directed the utilization and integration of TSGs into the K-9 program in 1972 to enhance the image and effectiveness of TSGs, to provide greater continuity in the program, and to aid in reducing retraining problems with assigned dogs. ^{56/}

Health and noise constraints limited the dogs somewhat in their use. Several parasites as well as a particularly deadly form of Leptospirosis (a liver disease similar to human hepatitis) were very prevalent in Thailand. (Five dogs died of this disease at Nakhon Phanom in early 1972.) Additionally, K-9s could not be used close to the flight line since aircraft noise and the constant movement of maintenance personnel severely reduced the dogs' ability to detect intruders. ^{57/}

~~CONFIDENTIAL~~

~~NOFORN~~

In early 1972, PACAF Manual 207-25, Aerospace Systems Security, was supplemented to require that all sentry dogs be retrained to be patrol dogs. This directive presented some difficulty since there were only three qualified trainers in Thailand at the time. The senior handler felt that the difference between the two types of dogs was essentially one of degree. Sentry dogs were trained to attack immediately while off-leash, and to "alert" while on leash. In contrast, patrol dogs, especially useful in a law enforcement role, were subjected to much more intensive obedience training and would "patrol" while off-leash and attack only on a specific command given by the handler. This intensive training was difficult and lengthy, with the result that all Thailand bases, except Takhli, possessed mostly sentry-trained dogs.^{58/}

Other training emphasis included attack and gunfire familiarization. This was a result of the U-Tapao experience where the dog failed to close with the intruders upon command.

Royal Thai Government Forces. In the period discussed in this report, the RTG had available several military and paramilitary forces which could be used in base security. These included the largest of the military forces, the Royal Thai Army (RTA), as well as infantry companies of the RTAF. The Royal Thai Navy (RTN) and its marines had troops around U-Tapao and Nakhon Phanom on the Mekong River. Additionally, the Thai Provincial Police (TPP), town police, and the Thai Border Police Patrol (BPP) were trained paramilitary units.

In August 1968, after the Udorn RTAFB attack, the RTG issued Thai Supreme Command Headquarters Order #340/2511 which specifically tasked RTARF commanders with responsibility to provide defense security for U.S.-tenanted bases. The order directed RTARF area commanders to immediately prepare joint base defense plans for the external patrol and defense of the bases. They were to establish a Base Defense Security Center (BDSC) at each base which would act as a coordination center for directing joint USAF/RTG response to any threatened enemy activity against the base. Unfortunately, this order was slow in being executed. By June 1969, although a few plans had been drafted, not a single base had implemented such a joint plan, perhaps because they were not effective instruments for obtaining defensive forces.^{59/} Continued efforts by USAF and embassy personnel, however, plus the added urgency given the subject by subsequent base attacks, combined to bring about the drafting of the remaining joint plans. In addition, successful joint defense exercises were held at every Thai base except Udorn* and the newly-activated Takhli.^{60/}

The vital need for off-base support by RTG units was reemphasized in a letter from General Searles to Major General Evans, COMUSMACTHAI in June 1972.^{61/}

The recently expressed concern about base defense by General Kraiangsak/Lt General Deputy Chief of Staff, Thai Supreme Command, corresponds with a period of increased threat to our bases. They are now such

*Udorn RTAFB presented special problems which will be discussed later in this report.

lucrative targets that they invite sapper and stand-off attacks. I think we need to pursue this expression of willingness on the part of the Thai Government to participate more actively in base defense. The need for a more substantive commitment by the Thais existed well before the 4 June sapper attack on Ubon, and it has certainly been heightened by that event. A point of special concern is the lack of organized and aggressive patrolling by Royal Thai forces outside base perimeters. They are neither deterring nor detecting enemy sappers before they attempt penetration. Of even greater concern is the possibility of stand-off attacks employing rockets and mortars. Recent intelligence information indicates that some stand-off weaponry has been brought in-country and more can be brought in quickly. Defeat of the Ubon and U-Tapao sapper attacks, and the increased concentration of aircraft on our bases should increase the possibility of stand-off attacks in the future.

As you know, our authority for base defense operations does not extend beyond the perimeter. We are absolutely dependent upon the Thais for off-base defense actions. More emphasis is needed in getting the Thai Border Patrol and Provincial Police units to work with us in accordance with the November 1970 agreement between the U.S. Operational Mission and the Thai Department of Public Safety.

In this agreement, the Thais were allocated vehicles, weapons, and communications equipment for use by specified police units in the performance of defensive efforts external to our base perimeters. It is my understanding that some of this equipment has been put to other uses and that much of it is in a poor state of repair. In addition, off-base patrolling by Thai military and para-military forces is either sporadic and ineffective or nonexistent.

I would appreciate your strong and continued support in keeping the subject of air base defense before appropriate Embassy and Thai officials. We need far more off-base support from the Thais if we are to protect our resources from both sapper and stand off attacks. The threat of such attacks has never been greater than at present.



The "recently expressed concern by General Kraiangsak" noted by General Searles occurred in an 11 May 1972 meeting between RTG officials and U.S. Embassy, COMUSMACTHAI, and USAF personnel during which the RTG admitted they had not provided command support nor had they supplied funds or resources needed by the units tasked with base defense missions. The Thais agreed to seek higher authority approval and support for the base defense mission of RTG forces. ^{62/}

Command concern over the RTG forces' role in external base patrol was never greater than in mid-1972. General Searles summed up the problem: ^{63/}

Air Force defense planners are handicapped because they are entirely dependent on the host government for external defenses and the host government is concerned with combating a communist-inspired insurgency. The people we depend on at the other side of the line cannot be depended on for a vigorous response to an emergency.

The RTG is either unable, or, in view of other problems such as insurgency, unwilling to defend USAF-tenanted bases. However, considerable progress has been made recently.

Civic Action Programs. In keeping with the philosophy of supporting the Thai government in its counterinsurgency (COIN) efforts without any direct U.S. involvement, the U.S. Embassy in 1968 restricted the wide range of civilian aid programs, known as "civic actions," being carried out independently by each base. Under the policy constraints imposed by the Embassy, direct USAF civic action programs were restricted to a 16 kilometer radius of the base and were subordinated to a base defense role. Any direct USAF



support for RTG COIN operations was prohibited. The limited programs allowed were intended to create a favorable climate among the Thai citizenry around the bases and thus enhance their defense posture by denying the enemy close-in support. Civic action further provided grass roots intelligence sources which were available to USAF ground combat intelligence specialists assigned to local SP forces.^{64/} The intelligence value of civic action was revealed in the 1970 Ubon attack when a local villager notified police of the presence of armed strangers, thereby alerting the base to the imminent attack several hours in advance.^{65/}

Specific examples of local utilization of the civic actions programs are reserved for discussion under "Base Analysis" in this report.

Contingency Forces. The USAF entered the SEAsia conflict unaccustomed to a role of total base defense. A series of attacks on USAF facilities in the Republic of Vietnam in 1965 and 1966 underscored the need for a specially-trained reserve force of combat infantry tasked with the mission of base defense. As USA participation in such a role was difficult to coordinate under a combat environment, the Air Force Chief of Staff directed that a special USAF security police unit be created to provide additional security for USAF resources in insurgency environments. As a result, Operation "Safe Side" was developed in 1966. Its mission was the creation of combat SP squadrons. The history of this force, which saw emergency deployments throughout Vietnam, is discussed in a CHECO report titled 7AF Local Base Defense Operations, Jul 65-Dec 68.^{66/} This special contingency unit

~~CONFIDENTIAL~~

~~NOFORN~~

was disbanded in 1971 because of various problems, including budgetary restrictions.

During the 1968-1970 time period, 7/13AF also recognized the very real need for a reserve force that could be deployed in the event of an emergency. U.S. Embassy and RTG officials agreed, with certain restrictions, to the air deployment of TSG units to relieve USAF forces which might come under a continuing attack. Prior permission from the U.S. Embassy and the RTG, however, was required prior to any deployment of out-of-country relief forces.^{67/} With the phase-out of the Safe Side forces, Headquarters USAF defense planners perceived a need for some form of contingency reserves that would operate as a self-contained mobile defense force. This force would be available for immediate deployment in support of weapons systems in hostile environments, civic disasters, and bare-base defense. There was also a need to avoid the difficulties that brought about the deactivation of the Safe Side program.

In 1972 USAF published AFR 125-32, Security Police Elements for Contingencies. Each major command was required to develop a Security Police Elements for Contingencies (SPECS) force within its command by tasking various subordinate bases with providing special units, such as a composite "Provisional Security Police Squadron," as well as all equipment and weapons for the personnel and mission of that particular unit. Under PACAF Manual 207-25, each unit was to receive special combat tactics training in accordance with the principles of base defense in an insurgency

~~CONFIDENTIAL~~

~~NOFORN~~

environment. This was to prepare them for the vastly different role of defense in the SEA environment as opposed to typical air base security under the provisions of AF Manuals 206-1 and 207-1. The latter two documents were essentially concerned with only vital resource defense and did not consider the problems of a total base defense posture. All personnel and equipment were to come from in-house resources and no extra funds or manning were authorized.^{68/}

A dramatic application of the SPECS concept came during Operation CONSTANT GUARD. This operation demonstrated the ability of the USAF to respond immediately to sudden requirements for the large-scale deployment of USAF units. In accordance with the decision of the President of the United States to assist the Republic of Vietnam in resisting the North Vietnamese aggression of April 1972, the USAF deployed massive forces in an impressive display of combat preparedness and mobility. Much of this manpower and aircraft strength was sent into Thailand as part of CONSTANT GUARD. The effectiveness of this deployment was best measured by the fact that these units were flying combat missions within five days following their deployment closure dates. (A CHECO report dealing with this operation was prepared in 1972.^{69/})

The deployment of these forces necessitated little adjustment by the security police at the established Thai air bases other than a need for additional personnel.^{70/} Part of the CONSTANT GUARD operation, however, included the reactivation of USAF flying operations at Takhli RTAFB

~~CONFIDENTIAL~~

~~NOFORN~~

during the first week of May. Most of the physical defenses had either been removed or rendered useless by deterioration during the year that Takhli had been closed to USAF operations.^{71/} Further, there were no in-place experienced base defense forces at Takhli. In a series of TDY actions, PACAF and Headquarters USAF sent several teams of SP personnel, as well as some support equipment, to Takhli. Initially, these forces were drawn from USAF units within Thailand. Later, PACAF detailed forces from Clark AFB and other non-SEAsia areas of PACAF, and, on 14 May 1972, Hq USAF sent the contingent of state-side SPECS.

The problems and accomplishments of these TDY units will be discussed in greater depth in this report under "Base Analysis." At this point, it is sufficient to say that the SPECS concept had yet to be fairly tried, since AFR 125-32 had not been fully implemented by the major commands by May 1972. PACAF, for example, was just in the process of coordinating its own regulation implementing AFR 125-32 with a target publication date of 15 July 1972.^{72/}

Limitations

Several constraints upon the maximum utilization of personnel have already been addressed, chiefly those involving the ability or willingness of the RTG to use its forces for base defense.

Headroom. Another limitation was the ceiling placed on the total number of U.S. military personnel allowed in Thailand by the RTG and the U.S. Embassy. The manning authorization for the SP squadrons reflected

that limitation. The TSG program was developed in 1966 to augment the USAF security forces permitted in the country.^{73/} Because of the assignment of TSGs, CSPs did not suffer a lack of sufficient people; however, their defense role was limited by difficulties of communication with, and integration of, the TSGs, as well as their inadequate training and arms in earlier years. These problems were generally resolved by 1972 as a result of continued command interest.^{74/}

Entry Control. Control of entry of Thai nationals on the bases, and their movements while on-base, was one of the more serious problems faced by the USAF SPs. This resulted from RTG and U.S. Embassy insistence that the bases be controlled by the Thai base commander. With the exception of Korat RTAFB (discussed under "Base Analysis"), gates at all other bases were manned by RTAF or RTN guards. USAF and TSG were present in an advisory role only.^{75/} Entry to the bases was dependent upon the issuance of a pass by the Thai base commander.

An investigation of the applicant was supposed to be undertaken prior to the issuance of the pass, but USAF personnel felt that it was inadequate. The problem was particularly serious in light of the 1972 intelligence estimates of enemy plans to conduct internal sabotage on several RTAF bases. A partial solution to the dilemma was increased emphasis on close-in resource protection and stringent personnel circulation control around vital resources.^{76/}

Rules of Engagement. Of even greater significance to base defense activities were the series of political constraints known as the Rules

of Engagement (ROE). These limitations were issued by the U.S. Embassy and COMUSMAGTHAI/JUSMAGTHAI after periodic consultations with the RTG during the period 1968-1972.

Two political considerations gave direction to the continuing formulation of the ROE. One was U.S. responsibility to avoid any appearance of military domination or occupation of Thailand and thereby deny support to CT propaganda efforts. A second factor in the promulgation of the ROE was the existence of dense civilian population centers in the proximity of the bases. ^{77/}

The ROE relative to transportation of military forces and the prohibition of direct U.S. aid to RTG COIN operations have already been discussed. Several of the ROE, however, dealt directly with matters of daily concern to defense personnel. Some time before the Udorn RTAFB 1968 attack, USAF SP personnel were prohibited from carrying firearms; that was the prerogative of the TSG. When weapons were allowed, they could only be carried in an unobtrusive manner, totally concealed when possible. After the 1968 attack, the ROE involving personnel utilization and physical defense aids were modified. A description of the former is covered here and the limits on physical aids are discussed in Chapter III.

The first compilation of ROE occurred in late 1968. It was approved by the U.S. Ambassador and was "binding on all members of the mission until changed formally." Among other things, the ROE directed that "U.S. personnel and weapons systems must not be used outside the base perimeters." This

~~CONFIDENTIAL~~

~~NOFORN~~

was defined as meaning no U.S. weapons of any kind would be used so as to "take effect" (impact) outside the base.^{78/} Small arms, crew-served weapons, and air delivered munitions were all included.

The July 1969 Ubon RTAFB attack revealed several dangerous weaknesses with such a broad limitation. As a result, the ROE were modified in November 1969. The new ROE were much more detailed in what could and could not be done in base defense. Small arms fire, for example, directed off-base was permissible if the base was receiving fire from some point, but only if the hostile target could be clearly identified and engaged with no danger to innocent civilian personnel. The ROE reaffirmed that air power could not be employed in fire missions and that no crew-served weapons could impact off-base. Embassy approval was needed for each type of weapon brought into Thailand and was also required prior to any joint Thai/U.S. base defense exercises. No U.S./TSG forces could be dispatched to reinforce other USAF units without prior Embassy approval.^{79/}

In 1970, the ROE were republished, but with some changes. One change stated that certain Embassy personnel besides the Ambassador could grant the required clearances in special circumstances. Permission was also granted to dispatch reinforcements from one USAF base to another in Thailand in an emergency without advance Embassy permission.^{80/}

The next significant development came with the publication of COMUSMACTHAI guidance on the carrying of firearms off-base in dangerous areas for purposes of self defense and escort duties. The decision to permit this at all bases

except U-Tapao RTNAF and Takhli RTAFB came about because of the severe insurgency problem in Northeastern Thailand. The final decision was left to USAF base commanders on a case-by-case basis.^{81/}

The last change to the ROE came in 1971, when the Embassy granted permission for U.S. commanders to use armed USAF SPs and TSGs to temporarily secure USAF off-base crash sites, ordnance drops, and similar sites involving U.S. equipment. This permission was limited to situations where RTG forces were unable to respond immediately, and was temporary, lasting only until their arrival.^{82/}

All of the ROE emphasized that under no circumstances would USAF or TSG personnel exercise any external base defense role, nor under any circumstances would they pursue any hostile forces off-base, even those withdrawing after an attack on the base.^{83/} PACAFM 207-25 was supplemented in 1971 to reflect these ROE and to avoid confusion in their application.^{84/}

Both the Deputy Commander 7/13AF and his Director of Security Police expressed concern in 1971 and 1972 over the fact that the ROE prohibited any USAF off-base patrolling activity and could severely handicap defense forces while compelling them to undertake a static defense role. The bases were cautioned on the need to seek ways to overcome the inherent weaknesses of such a role,^{85/} and several innovative base security officers developed programs which demonstrated that a static role need not be a stagnant one.

~~NOFORN~~

~~CONFIDENTIAL~~

Concept of Use

PACAFM 207-25 stated that defense forces would be used to defend the bases in essentially four areas. The base's exterior would be defended within a 16km area from the perimeter by Free World Military Forces (FWMF) other than USAF personnel. In Thailand this role fell to the RTA, RTAF, RTN (U-Tapao RTNAF), BPP, and TPP.

The base defenses themselves were divided into sectors in order to provide better command and control within each area, as well as to permit the forces within a given sector to be more familiar with the terrain and defenses around them.

Each sector had three lines of defense: (1) an exterior perimeter fence where detection and containment of enemy forces was expected; (2) a middle, secondary defense with roving security alert teams (SATs), working sentries and patrols dogs to detect any penetration of the base; and (3) a "close-in" site defense with defensive positions, roving patrols, and sentries posted with the aircraft. There was one sentry per eight aircraft in daylight hours and one per four at night except for B-52 and KC-135 aircraft, for which the coverage was doubled. Careful circulation control to prevent sabotage was to be maintained by restricted entry points manned by guards who were to deny access to unauthorized personnel.^{86/}

The figure on the following page illustrates the application of these concepts.

Base Analysis

This section will briefly examine base defense personnel problems and programs in light of PACAFM 207-25 and local agencies. Comparisons between bases are made to illustrate common areas of concern. Consideration will be given to: (1) available defense personnel as of mid-1972, both RTG and USAF/TSG; (2) coordination and cooperation between RTG and USAF units; (3) special base programs to increase effective utilization of those forces; (4) emphasis on defense in the petroleum, oil, and lubricants (POL) area, the MMS area, and the flight line area; and (5) circulation control in these areas. The main emphasis is on the first six months of 1972.

Korat RTAFB. This base was in a "low threat" area and had not undergone an attack as of June 1972. USAF security strength as of 15 May 1972 was 277 assigned SPs (155 authorized) including 39 SP K-9 handlers, 484 TSG, and 25 TSG (K-9) with 63 dogs. A total of 312 augmentees were available but except for an initial six-day training period and periodic retraining, they had not been used before the aircraft deployment.^{87/} Then, a few manned extra posts until an addition 48 TDY SPs arrived. Korat had the highest ratio of TSGs to USAF SPs of any base in Thailand.

The RTG presence was very pronounced. On one side of the perimeter was Fort Suranari, the headquarters and camp of the 2d Army (RTA). Camp Friendship, an RTA fort and training center for several hundred TSGs, bordered Korat on another section of perimeter. The RTAF's Wing 3 was

UNCLASSIFIED

TYPICAL 'ONE SECTOR' OPERATION

(EXTERNAL DEFENSE BY FWMF)

PREVENTIVE PERIMETER

(OBSERVATION TOWERS, FENCING, LIGHTING, MINES, ETC)

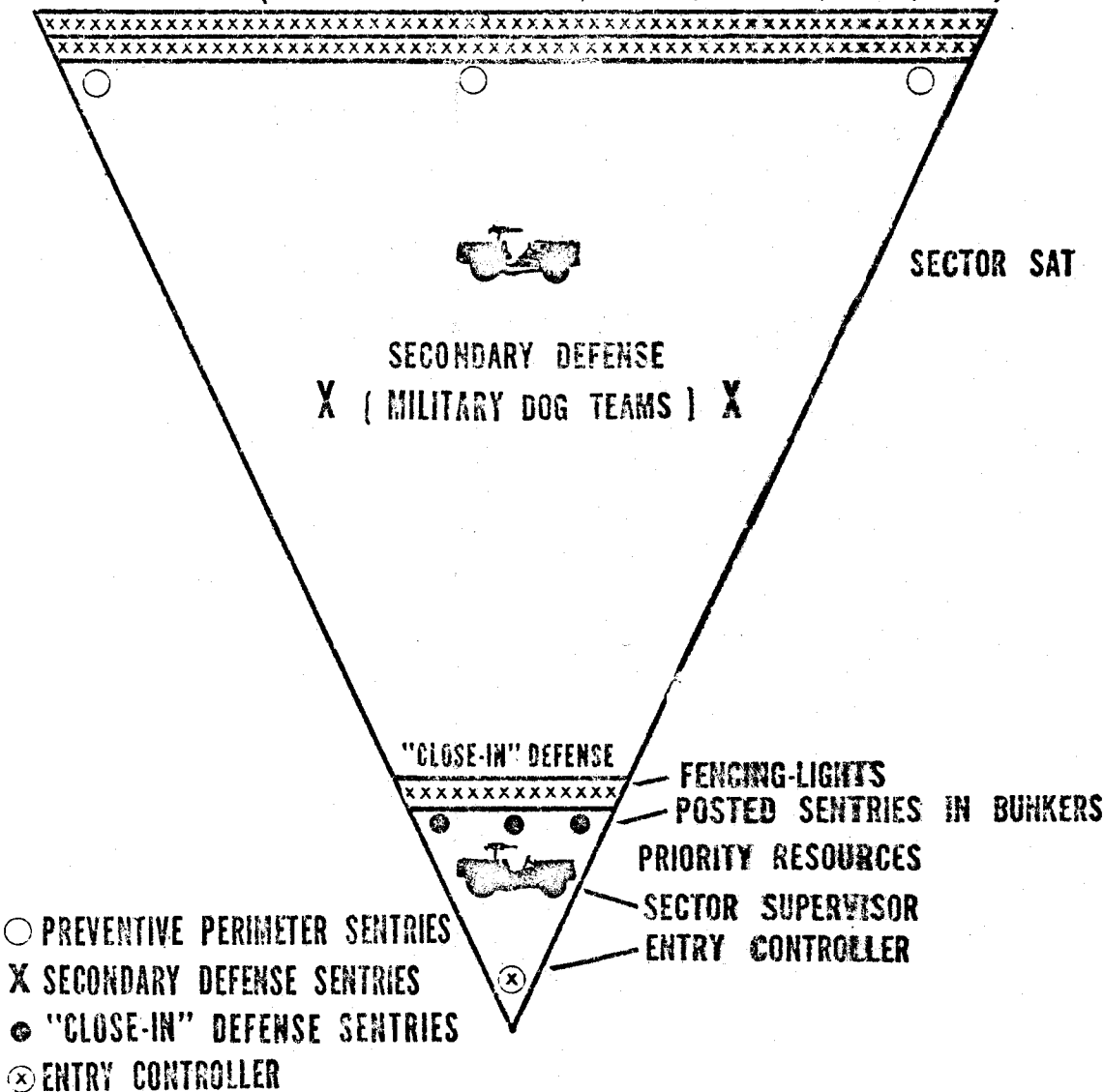

Typical One Sector Operation.

Typical One Sector Operation

FIGURE 4

UNCLASSIFIED

1954

1954

1954

1954

1954

1954

1954

1954

1954

1954



~~CONFIDENTIAL~~

~~NOFORN~~



KORAT RTAFB

1. POL area
2. On-Base MMS area
3. Off-Base MMS area, 4.5 miles
4. RTAF area

FIGURE 5

~~CONFIDENTIAL~~

1904



~~NOFORN~~

~~SECRET~~

~~CONFIDENTIAL~~

between them. The RTAF had a 1000-man combat infantry regiment on its portion of Korat. The TPP 3d Region Headquarters was also located nearby in Korat City. It had a special TPP 50-man Special Actions Force (SAF).

The chief of the 388 SPS characterized RTG and USAF cooperation and support as "highly motivated, but largely untried." Joint Base Defense Exercises had been held with great success. The Base Defense Security Center (BDSC) was located in the RTA Fort and was manned jointly by USAF and RTA personnel 24 hours a day.

Thai Provincial Police provided five patrols consisting of two to three men each during the critical-threat hours of darkness within a 5km area outside the perimeter. The TPP SAFs also maintained a 50-man reaction force on call to respond to incidents occurring during critical-threat hours within a 16km radius outside the perimeter. Five more TPP were on alert at the USAF CSC for dispatch to any suspicious activity observed around the perimeter. The RTA maintained a full RTA company on "alert" at Fort Suranari during the night.^{88/}

Only the RTAF support was considered deficient. Unfortunately, the RTAF area comprised a large section of the perimeter which was not defended by the USAF. The RTAF agreed to provide security for that area, but only during daylight hours.^{89/} The only USAF security was provided by sentry dog teams in that area and patrolling SAT jeeps, unsupported by any in-depth defenses.^{90/}

~~SECRET~~

~~CONFIDENTIAL~~

~~NOFORN~~

Intelligence-gathering efforts appeared to be spotty. The Ground Combat Intelligence (GCI) section received little meaningful information. They were confident, however, that this was due to the low threat, friendly environment. Once a week, GCI would make a daylight tour of the perimeter in an HH-43 fire-alert helicopter. More frequent day and evening patrols were not conducted because of the "low threat."^{91/}

The security forces at Korat deviated significantly from the "three rings of defense" concept set forth in PACAFM 207-25. The perimeters shared with RTG forces were under surveillance but were generally undefended. The middle line of defense was almost non-existent. The close-in, site defense was concentrated around the outside of the aircraft parking areas, but there were few sentries among the aircraft. This was especially critical in the KC-135 parking area closest to the perimeter and the open RTAF section of the perimeter.

The MMS and POL areas received strong sentry and K-9 close-in defense with the RTAF providing most of the POL security. This was significant in light of the fact that POL was in the RTAF sector and the main MMS area was four and one-half miles off-base. However, it was clear that POL and MMS defense was considered secondary to the resources on the flight line.^{92/}

One particularly unique agreement between the RTG/RTAF and the USAF existed at Korat. Gate entry control on most bases was performed by the RTAF, as has been previously discussed. By a 1969 order of the Thai Prime Minister, the USAF base commander was given exclusive control over entry

~~CONFIDENTIAL~~

~~NOFORN~~

on the USAF "side" of Korat RTAFB, including the right to stop and search anyone. This aided USAF defense personnel in their efforts to counter any internal sabotage threats. ^{93/}

Nakhon Phanom RTAFB. This base was considered to be a "high threat" area because of its proximity to Laos (14km) and the high level of CT activity in nearby villages.

In April 1972, USAF SPs numbered 354 and TSGs numbered 379. The RTG had committed an RTAF infantry battalion to the base area for defense. There were 151 TPP in the NKP District, and they provided three, six-man foot patrols nightly within a 16km circle around the external base perimeter. Both the RTA and RTAF also provided regular day and night external patrols. ^{94/} RTG support and cooperation were good, although their actual effectiveness was difficult to judge. ^{95/}

HH-53 helicopters from the local Rescue Squadron enabled the GCI personnel to conduct twice-nightly, three-hour reconnaissance patrols within an area 16km from the perimeter. GCI personnel utilized night observation devices to increase the effectiveness of the patrols. Close coordination between RTG ground forces responding in base-defense roles and the HH-53 had been practiced and was highly effective. ^{96/}

The base employed the "three-ring" defense concept, with K-9 patrols supplying the majority of the middle line. The "close-in" site defense of all vital resource areas was, however, inadequate. The lack of close-in

~~CONFIDENTIAL~~

~~NOFORN~~

defense left the POL area extremely vulnerable. Circulation control in the flight-line and MMS areas consisted of entry control which required Thai nationals to be escorted into the areas. Once in the areas, however, supervision was lax. Thais with no close supervision were observed in close proximity to aircraft. Also, no one maintained any numerical accountability of Thai personnel in the MMS area, and, thus, there was no way of ascertaining whether some had remained hidden within the area at night. In light of the high risk of internal sabotage, the lack of effective circulation control and intensive "close-in" defense created a potentially serious threat to the defense posture.^{97/}

Takhli RTAFB. As mentioned previously, Takhli was closed to USAF operations from 8 April 1971 until early May 1972. Special contingency forces from within Thailand and, later, from other PACAF bases provided initial defense support for the newly-deployed F-4 wing and the KC-135 squadron. On 14 May, SPECS units from other bases were deployed to Takhli. By 30 June 1972, there were three permanently-assigned SPs, 340 SPs were there in a TDY status, and the base had 22 sentry dogs. There were no TSG forces at Takhli.

The RTAF had a 1000-man infantry unit in training at the base, and they provided the only perimeter security for the base. The TPP could not provide external support due to a lack of transportation equipment.^{98/}

At that time, there was no Joint Base Defense Plan, but the RTAF and USAF had nevertheless decided that RTG forces would be responsible for

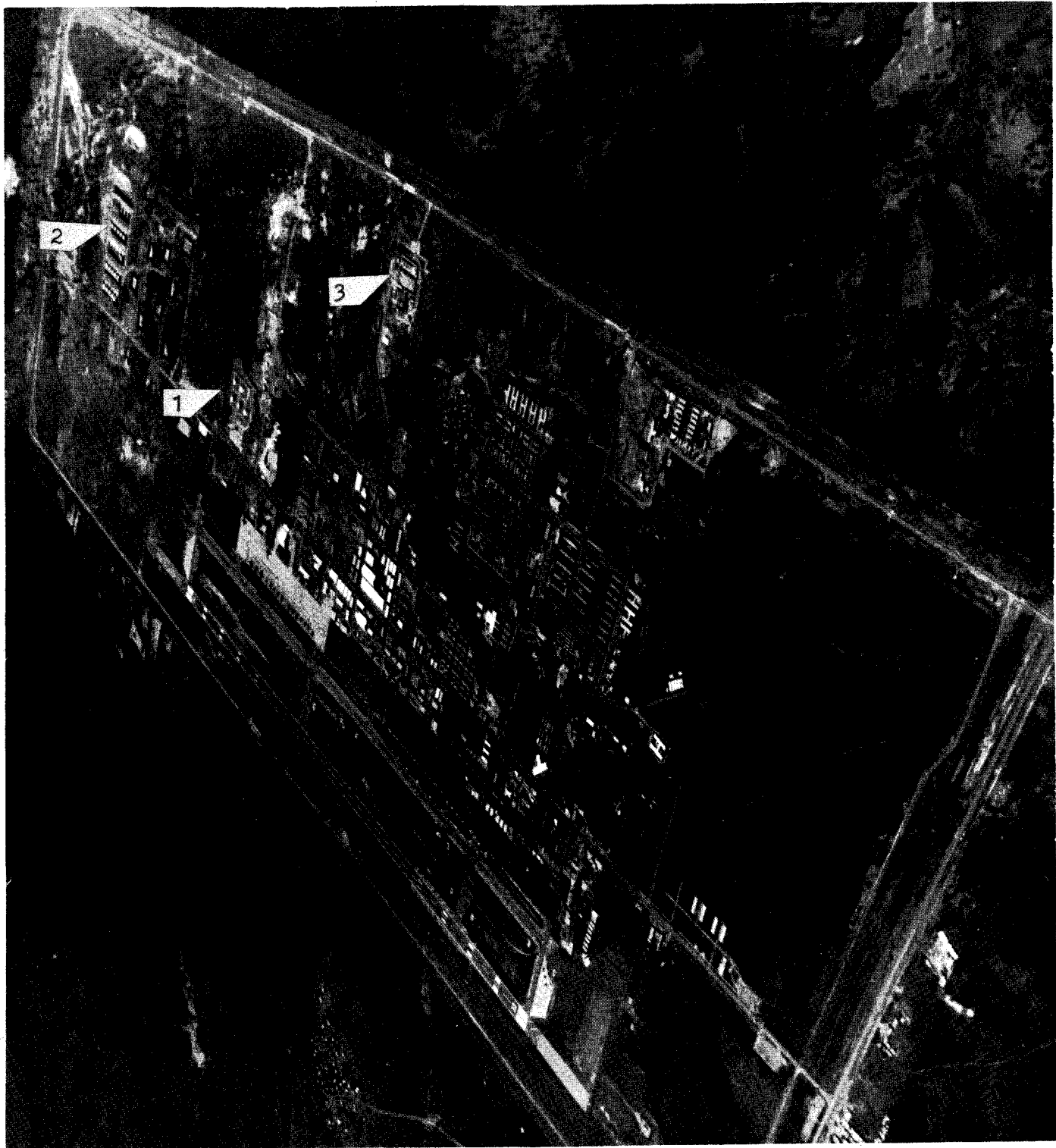

NAKHON PHANOM RTAFB

- 1. POL area
- 2. MMS area
- 3. Task Force ALPHA

FIGURE 6

1950

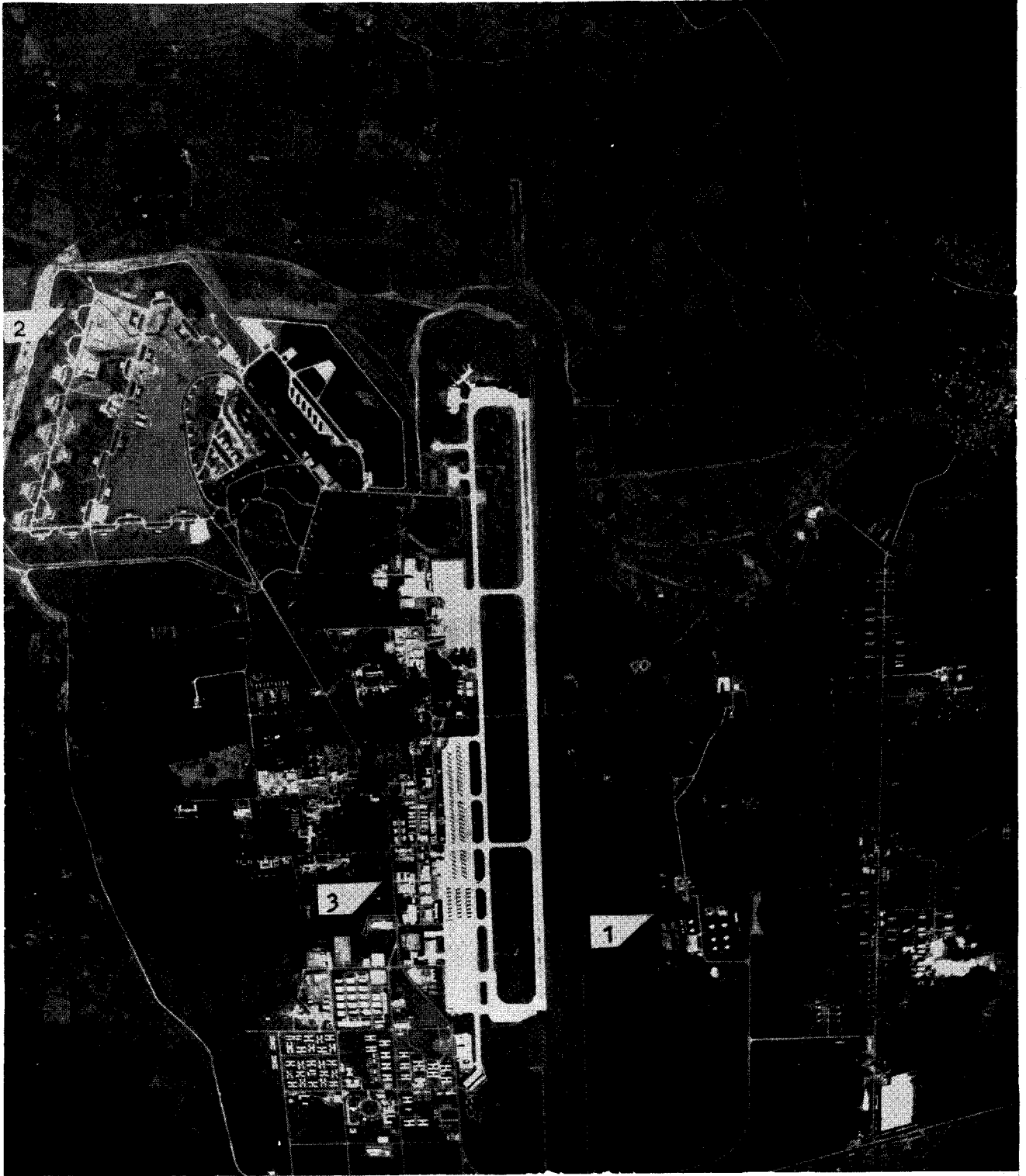

TAKHLI RTAFB

- 1. Joint POL area
- 2. Joint MMS area
- 3. Road making inner defense line

FIGURE 7

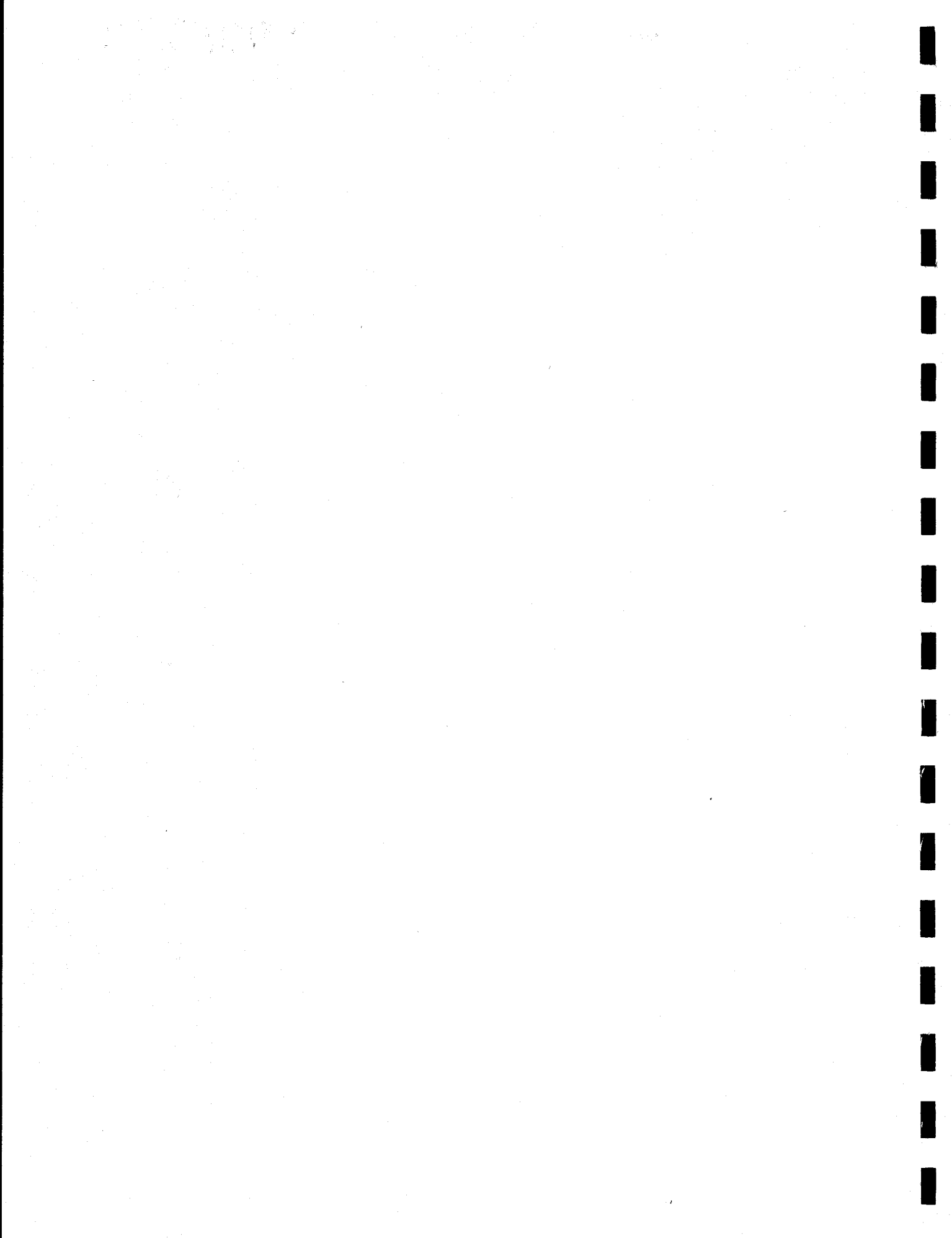

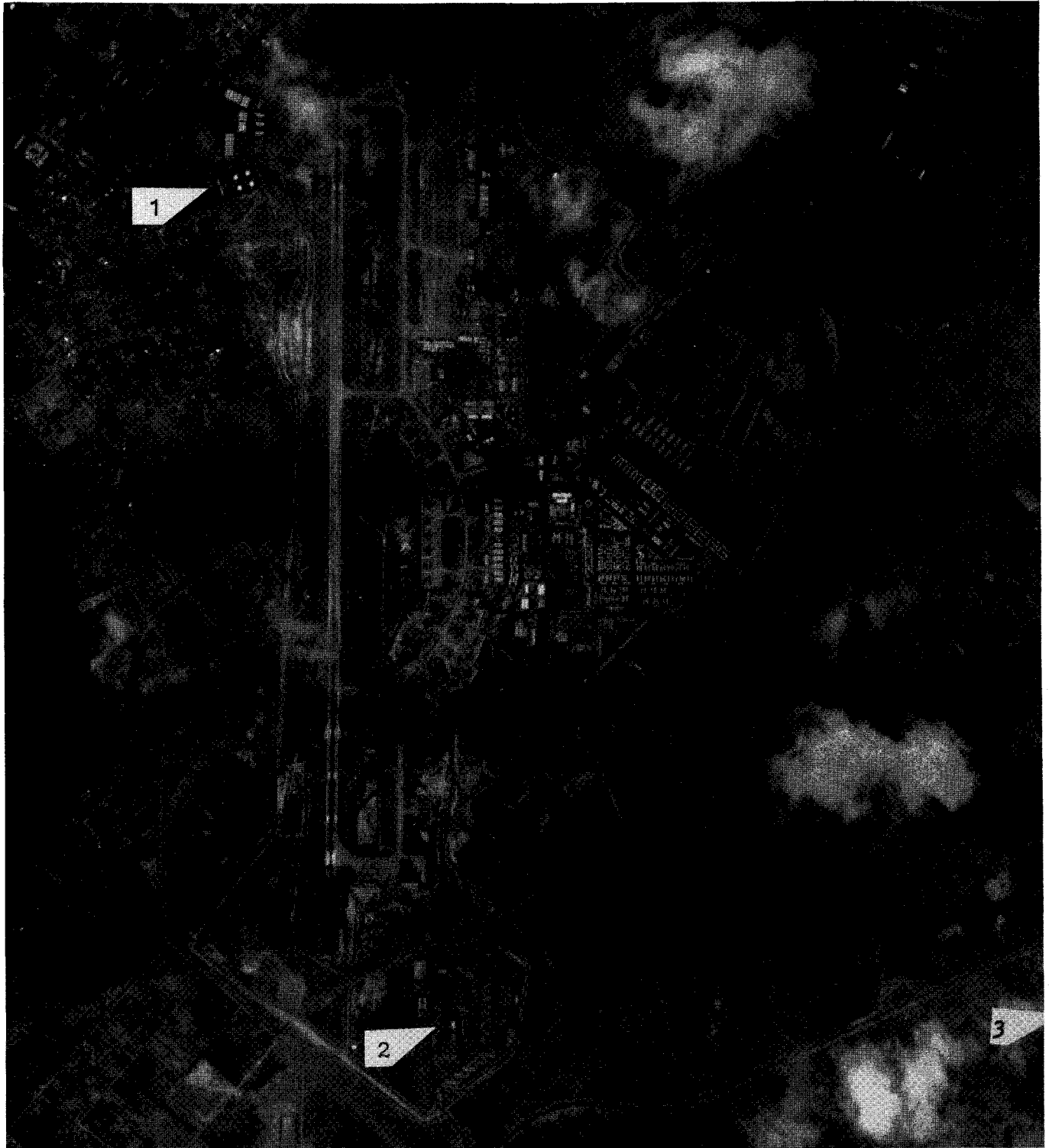

UBON RTAFB

1. POL area
2. MMS area
3. Off-Base MMS area, 6 miles

FIGURE 8

1110-104



~~CONFIDENTIAL~~

~~NOFORN~~

perimeter defense while the USAF would provide only "middle" and "close-in" site defense in the immediate vicinity of the USAF aircraft parking area. USAF also defended a portion of the joint USAF/RTAF MMS area and provided two sentry dog teams for the POL dump. Both the MMS and POL areas were outside the USAF defensive perimeter.^{99/}

There was little close coordination and planning between the RTAF and the SPECS forces. Also, no Base Defense Security Center had been established.^{100/}

The SPECS unit operated under two severe limitations. First, most of their personnel were SPs who had operated under AFM 206-1 and AFM 207-1 which were the references for resource defense in a non-SEAsia environment. These personnel were not familiar with PACAFM 207-25 tactics and concepts which were used in Thailand, and because of the newness of the program, few SPECS personnel had received any training for their role under PACAFM 207-25.^{101/} Secondly, equipment and physical defenses were lacking. These problems will be examined in Chapter III.

Ubon RTAFB. The danger to Ubon was best illustrated by the three attacks between 1969 and 1972, as well as its proximity to the Laotian border and CT activities in the area.

There were 363 SPs and 507 TSGs assigned to the 8th SPS on 31 May 1972. These included 35 SPs TDY from Clark AFB, assigned as a result of the deployment.^{102/}

~~CONFIDENTIAL~~

~~NOFORN~~

RTG cooperation in the Ubon area was mainly in intelligence gathering. There was no RTAF infantry, and few other RTG forces were available in the event of an attack, although the TPP did provide two regular three-man jeep patrols in the 16km area around the base perimeter. An unarmed USAF security policeman was allowed to accompany each of the "Liaison Patrols" for coordination and communication with the base CSC. These patrols facilitated RTG response to unexplained activity outside the perimeter. On the other hand, during the 4 June 1972 attack, it took more than an hour for the RTA "alert" forces to respond. The RTAF and RTA did not man the joint BDSC except during alert conditions, although they had cooperated in highly successful joint exercises. Additionally, the BPP frequently patrolled villages within the 16km circle, as did Special Actions Forces of the TPP. Local RTG commanders were anxious to assist in base defense, but they lacked the equipment and communication capabilities essential for a high level of effectiveness. 103/

Infrequent daytime use of the HH-43 fire-fighting helicopter stemmed from the SP approach, since the rescue unit had indicated a willingness to conduct regular night missions. The HH-43 was used for illumination the night of the 4 June attack.

In mid-1972, the Chief of Security Police at Ubon RTAFB indicated that the single greatest problem facing him as a defense planner was the gap between supervisory personnel and the SPs on post. This, he felt, was due to a lack of sufficient professional training which resulted in

~~CONFIDENTIAL~~

~~SECRET~~

~~NOFORN~~

senior NCOs avoiding close supervision of their subordinates. He sought to remedy this problem by subdividing each main section of the base and assigning SP/TSG forces to a particular sub-section. This enabled each supervisor to make frequent post checks and maintain close contact with each man, thereby achieving better discipline, morale, and defense alertness.

To provide the needed "professionalism," frequent training exercises were held and job specialization was emphasized to a much greater degree than in normal SP squadrons. One such "specialty" was the Standboard, manned permanently by a senior NCO. This mission element was responsible for conducting exercises and standardizing the defense responses to given situations.^{104/} This emphasis on professionalism and close supervisory control was justified by the response this force showed in the 4 June attack.

The smallness of Ubon RTAFB made employment of the "three rings of defense" very difficult. In one sector, the AC-130 aircraft were but 200 meters from the fence. POL was only lightly defended by posted sentries. Both the on-base MMS and the MMS area located six miles off-base were defended in-depth and a sign-in/sign-out procedure maintained accountability of Thai nationals inside.

Circulation control on the flight line was provided by the usual entry controllers and random posts, including several built into strategic positions in the top of the aircraft revetments. A major weakness existed

~~SECRET~~

~~CONFIDENTIAL~~

~~NOFORN~~

during the deployment period in that several of the "close-in" defensive positions were manned by inexperienced augmentees with one to three days of training. This augmentation occurred during the "Yellow" security alert condition which followed the 4 June attack.^{105/}

Udorn RTAFB. In many respects, Udorn in 1968 and in 1972 was the base most vulnerable to attack. It contained large numbers of F-4 "targets," was in an area with a high concentration of CT, and had the worst geographic constraints of any base. (See Chapter III.) Furthermore, the serious lack of local RTG cooperation or support in the base defense mission jeopardized the defense posture. In October 1971, the Deputy Commander, 7/13AF, in a letter to the Commander, 432TRW, cited the base defense as "inadequate."^{106/} This assessment was particularly grave in light of intelligence estimates:^{107/}

A representative of another United States Government Organization has furnished this Headquarters 7/13AF with a report alleging enemy (NVA) plans to attack Udorn RTAFB in the near future. . . . This report states the group will enter Thailand armed with heavy weapons such as mortars, B-40 rockets/rocket propelled grenades and other kinds of explosive ordnance.

Serious efforts at securing local RTG cooperation were continued and, in June 1972, the RTA Commander, Major General Chau, reissued a base defense plan and promised to hold exercises "in the future." Despite the fact that the RTAF had expressed a willingness to conduct regular off-base patrols within 5km around the perimeter, the new plan still prohibited RTAF troop deployment in support of base defense without the prior approval of the RTA commander in person.^{108/}

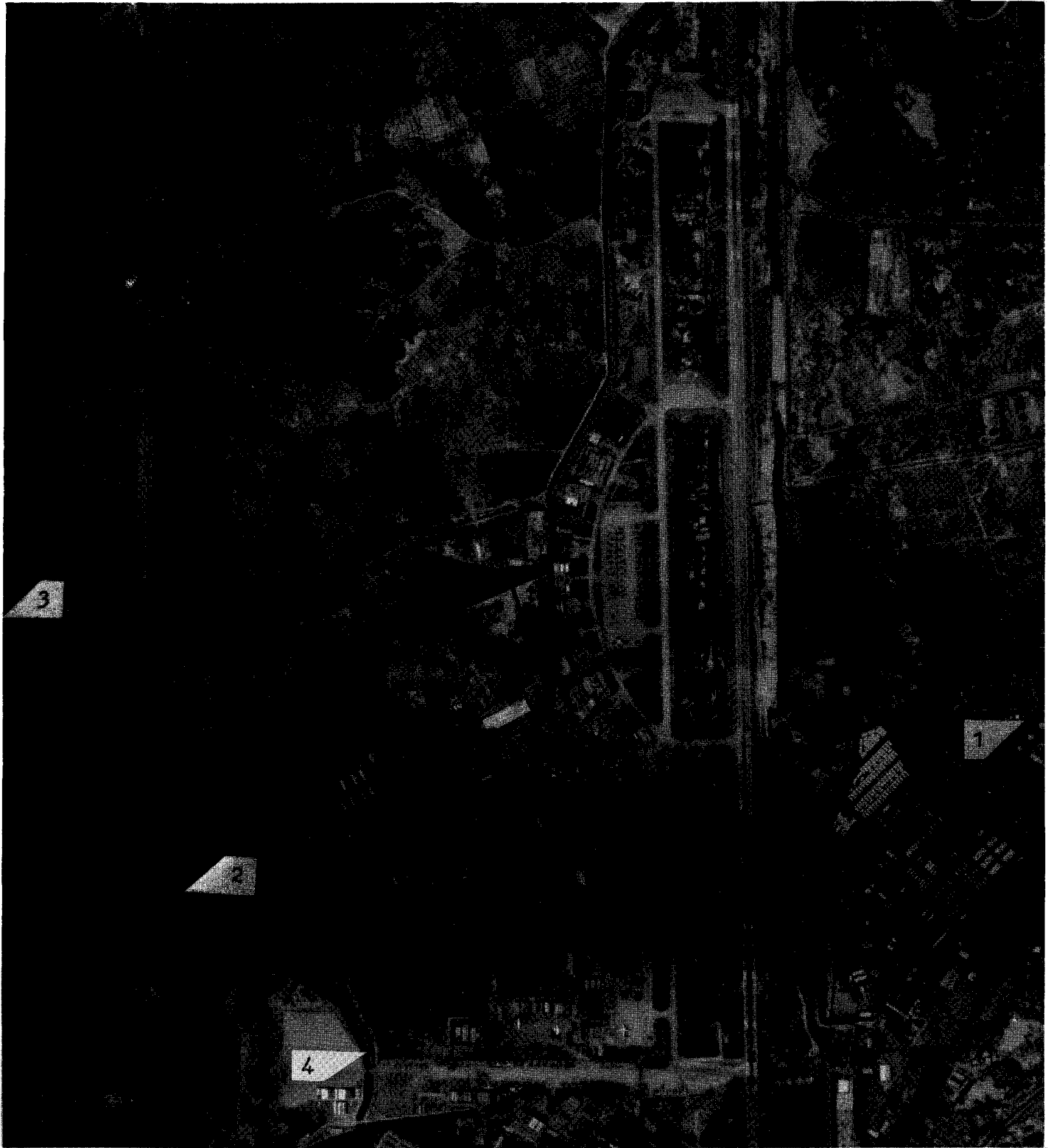

UDRON RTAFB

- 1. POL area
- 2. Off-Base MMS area #1
- 3. Off-Base MMS Area #2, 1 mile
- 4. Air America Operation

FIGURE 9

WFOFOIA



~~CONFIDENTIAL~~

~~NOFORN~~

In January 1972, the RTA failed to provide external defense despite the fact that intelligence estimates indicated a strong possibility of enemy action.^{109/} The only reason ever offered for this lack of cooperation by local RTG authorities was that they needed POL support for their transportation. Thirteenth Air Force promptly authorized this support, but there was no increased cooperation.^{110/} When Ubon was attacked on 4 June, Udorn RTAFB entered a Red Alert Security Condition and urgently requested RTA support under the May 1972 joint-defense plan. None was forthcoming, and this prompted USA advisors to comment: "Advisors here feel that the quick reaction capacity committed to the RTAF base defense in the plan existed only on paper and did not, in effect, exist."^{111/}

Despite the apparent willingness of RTAF forces to assist in internal security of vital resources, USAF security personnel chose not to utilize the available infantry force in any direct defense role. The reason for this was the inadequate RTAF training and their lack of familiarity with the USAF tactics and positions.^{112/}

At Udorn, manning in mid-1972 stood at 297 USAF SPs and 427 TSGs. An additional 25 SPs were sent TDY from Clark AFB during the deployment.

As at Ubon, the Udorn POL area was inadequately defended. It was contiguous to civilian housing and to a major highway. This "indefensible" situation was recognized by base authorities.^{113/}

~~CONFIDENTIAL~~

~~NOFORN~~

There were also two off-base MMS areas--one a few hundred meters from the perimeter and the other about a mile from the gate. Both were very lightly defended and were highly vulnerable to attack and destruction. ^{114/}

No regular use of the HH-43 helicopters was undertaken for exterior patrol efforts, although it was available to "check-out any suspicious activities." ^{115/}

Because of the limited base area, the "three rings of defense" concept was not followed in all areas of the perimeter. Additionally, Udorn shared a section of the perimeter with Air America, a U.S. Government-owned airline operation. There was no existing defense of that common perimeter although an agreement was reached in June 1972 between USAF and MACTHAI whereby the USAF could initiate limited defense of that area in July. There was a very sophisticated "close-in" defense around the aircraft consisting of perimeter sentries who had excellent circulation observation and control. ^{116/} There was a danger, however, that an enemy who had penetrated this far might then be too close to vital resources for their successful defense.

U-Tapao RTNAF. Once thought to be the most secure base in Thailand, this installation received what could have been a devastating lesson early in 1972. Fortunately, the attack did more damage to the illusion of safety than to the strike capability of this vital USAF installation. The attack

~~CONFIDENTIAL~~

~~NOFORN~~

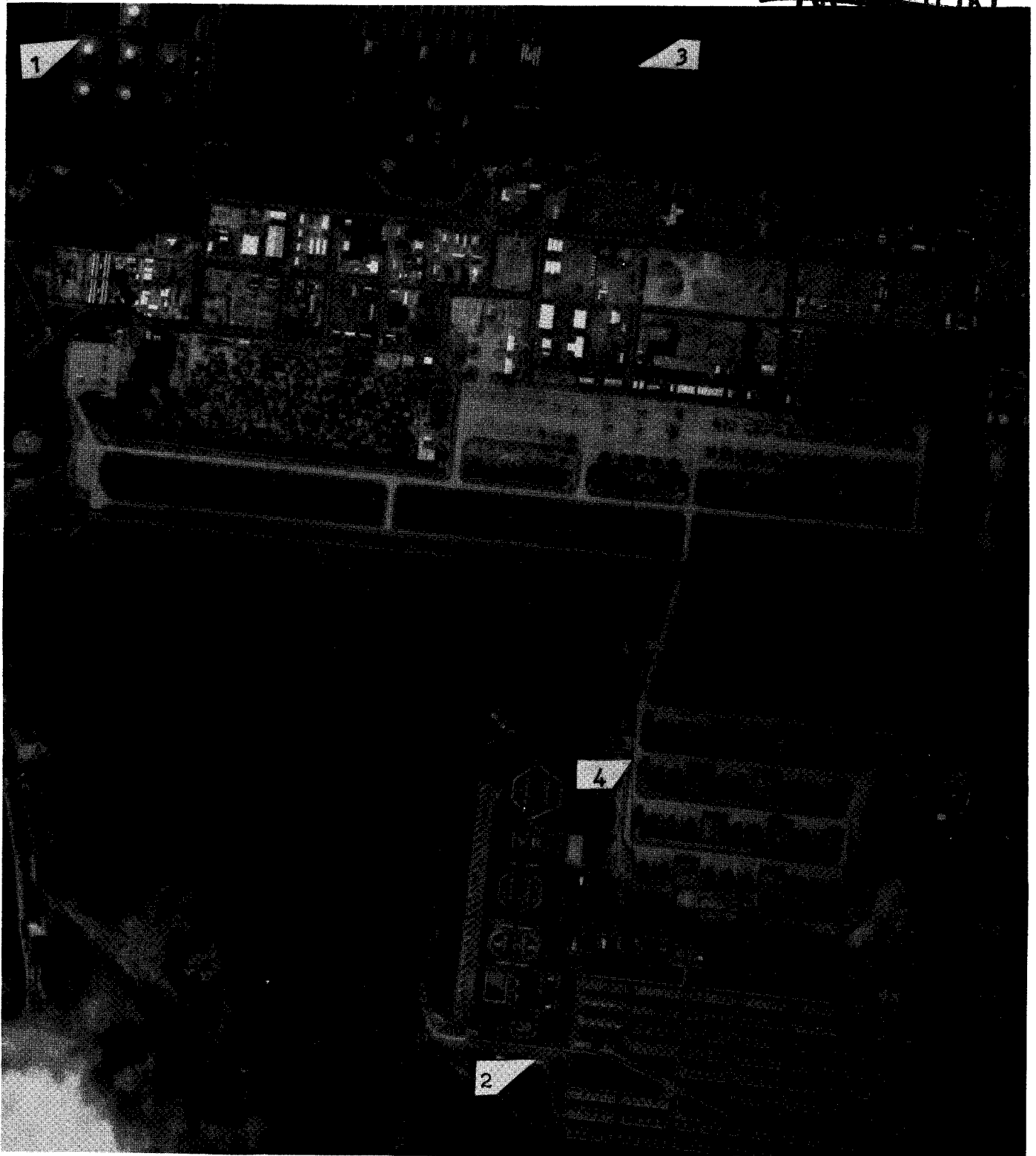

- 1. POL AREA
- 2. MMS AREA
- 3. On-Base Thai Village
- 4. B-52 Ramp

U-TAPO RTNAF

FIGURE 10

~~CONFIDENTIAL~~

~~NOFORN~~

NOFORN



had the desirable effect of catalyzing action aimed at the development of an effective defense concept tailored to the unique problems at U-Tapao RTNAF.

U-Tapao RTNAF was the largest USAF facility in Thailand, both geographically and operationally. As such, in June 1972, it had the largest security force: 450 SPs, including 46 SPs TDY from Clark AB sent during the deployment; 537 TSGs; and 49 sentry/patrol dogs.

RTG cooperation in base defense, both during the January attack and continuing through June, remained excellent. Royal Thai Navy Marines (RTNM) in 20-man units conducted regular, vigorous 24-hour patrols outside the base perimeter. The RTN conducted evening patrol-boat sweeps on the sea side of the perimeter. Thai Provincial Police also cooperated and patrolled the exterior area during increased security alert conditions. USAF and RTN personnel manned the BDSC 24 hours a day. Even though U-Tapao did not have a formal Joint Base Defense Plan by mid-1972, RTG emergency-response capability was considered significantly above average for Thai bases.^{117/} Despite all these efforts, however, the actual net effect was difficult to assess as indicated in a message from the CSP in July 1972:^{118/}

The external defense provided by the RTG and Provincial Police forces is adequate; however, their true capability and effectiveness is seriously limited. The Thai units . . . are highly motivated, adequately trained and willing to help . . . however, their combat capability is limited by adverse manning, outdated weapons, lack of communications equipment, limited vehicle fleet, and inadequate fuel allocation for their vehicles.

Regular HH-43 helicopter patrols of the perimeter were made at night. Additionally, defense personnel were coordinating plans with the RTNM to conduct evening "liaison patrols" of off-base areas around the perimeter. This concept was similar to that developed at Ubon RTAFB.

Several significant personnel actions resulted from lessons learned in the January attack. First, despite the large defense force, the 19-1/2km perimeter, taken with other geographic constraints discussed in Chapter III, made perimeter defense difficult. The ease with which the January sappers moved once they penetrated the base clearly demonstrated the inherent risks of an "egg-shell" perimeter defense posture. An effective, in-depth, middle-line-of-defense was developed for personnel utilization. Plans were made for sophisticated physical barriers in this manageable middle ring. Additional close-in defenses were tightened and strengthened. Each aircraft revetment was guarded by either an SP or TSG, and K-9 patrols were concentrated in the middle defenses and in areas around the resources.^{119/} Several ambush sites were manned in the large, densely foliated regions inside the perimeter. Regular full-field exercises were conducted on the seashore perimeter with live fire from machineguns, grenades, and small arms used to provide tactical experience with these weapons.^{120/}

Circulation control in the aircraft area was generally excellent, possibly reflecting the several years' experience that the Strategic Air Command had with this type of defense measure. The POL and MMS areas, however, were not defended in the depth evident on the flight line. This,

~~CONFIDENTIAL~~

~~SECRET~~

~~NOFORN~~

of course, was typical of the majority of Thailand bases and reflected the relative priorities dictated by resource limitations. Circulation control in the MMS area was tightened after the January intrusion. Various intelligence sources indicated the threat of sapper penetration of the base via the hundreds of trucks that each day delivered bombs to the base MMS, which was adjacent to the B-52 parking ramp. Careful searches of these trucks were routinely performed. ^{121/}

The major problem facing security forces in 1972 was summed up by the Chief of Security Police at U-Tapao RTNAF in the following words: ^{122/}

Mission motivation is critical. The security policemen would want to do a good job if they felt the situation called for it. But this is hard because the small threat here gives rise to apathy; morale is not a problem, boredom is!

This place is not indefensible. It is a little harder than most other bases, but it can be effectively and adequately defended with presently available resources if our people believe it can!

~~SECRET~~

1970-1971

[REDACTED]

The first part of the report deals with the general situation in the country. It is noted that the economy is in a state of stagnation and that the government is unable to meet its obligations. The report also mentions that the population is suffering from a severe shortage of food and that the government is unable to provide for the basic needs of the people.

The second part of the report deals with the political situation. It is noted that the government is unable to carry out its policies and that the country is in a state of political instability. The report also mentions that the opposition is growing and that the government is unable to maintain its authority.

The third part of the report deals with the social situation. It is noted that the population is suffering from a severe shortage of food and that the government is unable to provide for the basic needs of the people. The report also mentions that the population is suffering from a severe shortage of housing and that the government is unable to provide for the basic needs of the people.

The fourth part of the report deals with the economic situation. It is noted that the economy is in a state of stagnation and that the government is unable to meet its obligations. The report also mentions that the population is suffering from a severe shortage of food and that the government is unable to provide for the basic needs of the people.

The fifth part of the report deals with the international situation. It is noted that the country is in a state of political instability and that the government is unable to carry out its policies. The report also mentions that the population is suffering from a severe shortage of food and that the government is unable to provide for the basic needs of the people.

[REDACTED]



~~CONFIDENTIAL~~

~~NOFORN~~

CHAPTER III

PHYSICAL DEFENSES AND LIMITATIONS

Introduction

An effective base physical defense environment has as its goal four objectives: the detection, detention, and destruction of the enemy; and, of greatest importance, the preservation of vital resources while accomplishing the preceding objectives.

This chapter briefly considers four aspects of physical defenses as they existed in Thailand from 1968 to 1972. First, it examines active defense systems designed to aid personnel in the detection, containment, and response to an enemy intrusion. Then, the chapter details passive defense measures designed to protect personnel and vital resources during an attack. It explores the limitations imposed by natural conditions as well as political and economic constraints on the use of defensive devices. Finally, it briefly discusses some of the specific difficulties and achievements. No effort is made to duplicate concepts discussed in PACAFM 207-25.

Two CHECO reports on base defense concepts and measures in the Republic of Vietnam provide additional information. ^{123/}

Active and Passive Defense Measures

The first "ring of defense" within the bounds of USAF responsibility was the base perimeter, usually composed of fence lines and other integrated

defenses, all designed to expose the enemy to an increased risk of observation and detection. No base considered itself secure because of an impenetrable perimeter, for as one Chief of Security Police stated: "Fences only keep honest people and cattle out, they don't stop determined sapper squads."^{124/}

Perimeter lines at most bases consisted of various combinations of rolls of concertina wire, "tangle-foot" barbed-wire barriers, and, occasionally, chain-link fences. Some bases placed trip-flares among the fences. These had wires which, when disturbed, would trigger the flare. (The figures on the following pages illustrate some of the typical perimeter defense concepts.) All bases (except Takhli RTAFB) had generally adequate lighting on the perimeter fences and several had NF-2 Light-All units to provide additional illumination as backup or in critical areas. Most of the bases had Xenon lights with the capability of lighting several hundred meters with either infrared or visible light; however, not a single base was able to fully utilize these units, either because of maintenance difficulties or insufficient manning. Most installations also had various night observation devices (NODs) such as starlight scopes or the more expensive tower-mounted NODs. Unfortunately, no base had sufficient numbers of these devices to permit visual observation of the entire base perimeter. To further aid in observation, herbicides were employed to assist in the difficult task of vegetation control. Use of these agents was limited by such factors as the ROE and supply problems.

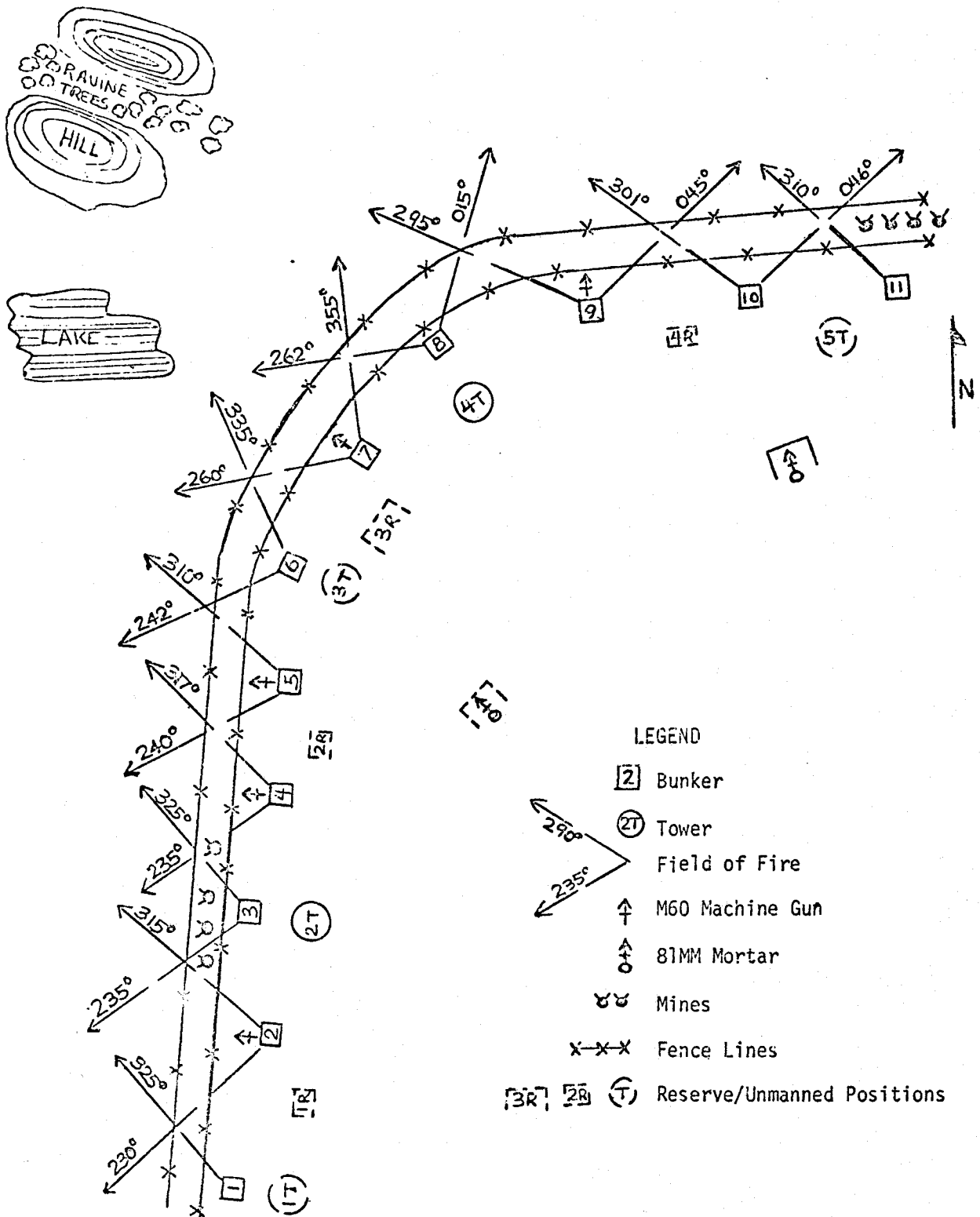

LEGEND

- [2] Bunker
- (2T) Tower
- Field of Fire
- ↑ M60 Machine Gun
- ↑ 81MM Mortar
- ⌘ Mines
- x-x-x Fence Lines
- [3R], [2R], (T) Reserve/Unmanned Positions

Perimeter Defense System

FIGURE 11

1950

1951

1952

1953

1954

1955

1956

1957

1958

1959

1960

1961

1962

1963

1964

1965

1966

1967

1968

1969

1970



TAUT HORIZONTAL SUPPORT
WIRE RACKED TO UPPER
CONCERTINA HALFWAY
BETWEEN PICKETS

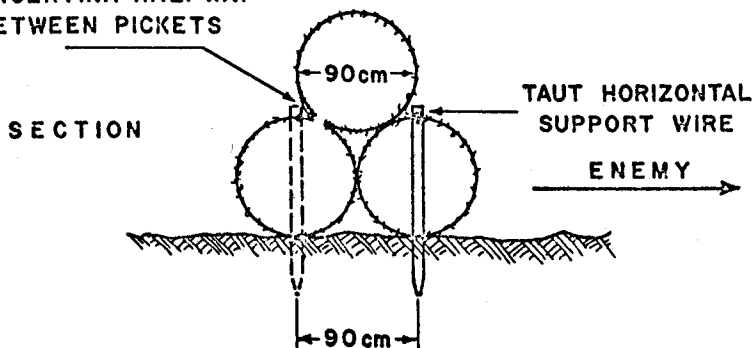
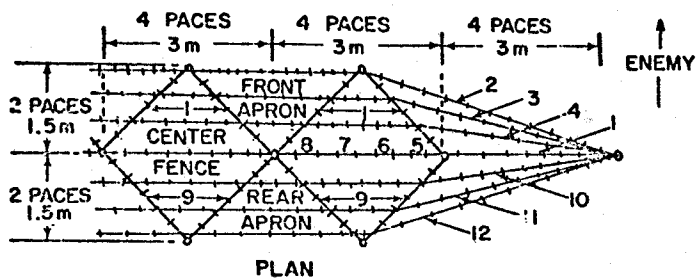
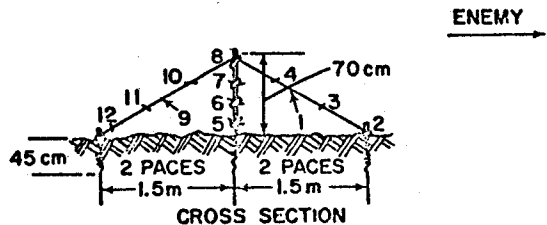

Figure 3-1. Triple Standard Concertina Fence.



NOTE:
EYES OF ALL PICKETS POINT
IN DIRECTION FROM WHICH
FENCE IS BEING ERRECTED.

Figure 3-2. Double Apron Fence.



Defensive Perimeter Fences

FIGURE 12

1960

1960

1960

~~CONFIDENTIAL~~

~~NOFORN~~

Only one base made use of any form of Tactical Security Support Equipment. In January 1971, Nakhon Phanom RTAFB was the test base for the Westinghouse AN/GSS-15 Alarm Set. This system of intrusion detection used the Balanced Pressure System (BPS). Test results were highly satisfactory. From January 1971 through June 1972, the system averaged 90 percent operational effectiveness. Future plans called for the late 1972 completion of the NKP perimeter and the installation of equipment at U-Tapao, Ubon, and Udorn RTAFB.^{125/} The system at Nakhon Phanom was not really an integrated part of the base defenses in mid-1972. The system covered about 30 percent of the base perimeter, but all of the sensory "actuators" or alert lights were located in one observation tower. That tower had no opportunity to observe all portions of the perimeter covered by the BPS. Effective use would have required that each section of the perimeter be under observation by a tower guard who would be alerted by an alarm triggered by any intrusion in his sector. Delay in communicating an alarm from one tower to the sector guard in the area being penetrated would have effectively prevented detection.^{126/}

Great variations in perimeter defenses and detection devices were evident in 1972. PACAFM 207-25 and periodic staff visits by 7/13AF Security Police personnel provided the only command guidance. Variations in amount and types of fencing, use of trip-flares, tower height and positioning, and circulation control procedures were in evidence from base to base. Inner defenses also varied significantly, both from each other and from PACAFM 207-25.^{127/} No base had close-in defense perimeters

~~CONFIDENTIAL~~

~~SECRET~~ ~~NOFORN~~

meeting the manual's standards, and none possessed intrusion detection devices, such as trip-flares, around the vital resources. Further, defensive fencing around such resources was generally incomplete or non-existent, thereby limiting the site defenses to reliance upon human sentries alone. Even this detection capability was hindered by inadequate lighting around the perimeter of the close-in defenses, and aircraft noise also served to complicate detection. This absence of in-depth site protection was not due to any lack of perception by defense planners, but, rather, was dictated by various practical considerations such as access to the flight-line areas by maintenance personnel and equipment.

The second and third objectives of active defense were to contain an enemy and respond with adequate forces to destroy or repel him. Both fencing and illumination were significant in providing this ability. Slap-flares and 81mm mortars with illumination rounds were available at all bases for use during any attempted or suspected penetration effort by sappers.

Two significant deficiencies in base defenses existed throughout Thailand and seriously limited the response capability of defense forces. The first was a lack of adequate communications, and the second was vehicle problems. Most bases had radios with only a two-channel capacity; while adequate under normal conditions, the urgency created by an emergency plus the difficulties of a multilingual defense force seriously overburdened this system at times. ^{128/} Further, maintenance problems and lack of

~~CONFIDENTIAL~~

~~NOFORN~~

sufficient quantities of vehicles, such as the armored personnel carriers (APC/113 and APC/706) and other rough terrain vehicles, made them the number one priority need of almost all bases. ^{129/}

In addition to the foregoing, mines were another "response" device. The ROE prohibited "Claymore" mines in Thailand, ^{130/} but in 1970 U.S. Embassy permission was given for limited use of A/E 25P-1 "pop-up" mines at all bases except Korat RTAFB and Don Muang Airfield, Bangkok. ^{131/} These command-detonated mines were not in use as of June 1972, but 400 were programmed as part of the defenses of U-Tapao RTNAF, the Thai test base, for late 1972. ^{132/}

Response capability to a stand-off RAM attack was extremely limited. The ROE prohibited employment of USAF firepower or aircraft in any suppression role. ^{133/} Only close coordination with RTG units provided any form of active defense. However, most bases did not have the capability to direct RTG units to a suspected launch site. Several bases possessed mechanical triangulation devices known as "azimuth boards" that enabled a fairly accurate plot of RAM element sources if two observers located the launch site and used the plotting device correctly. Defense personnel, however, admitted that use of the board was not practical and field exercises emphasizing its use were not conducted. Further, except for Nakhon Phanom's HH-53 helicopter exercises, no serious practice of close coordination with external RTG forces targeted to a simulated RAM site was undertaken. Failure to utilize these potentially effective RAM countermeasures was a result of the perceived "low" threat. ^{134/}

Passive defenses for RAM attacks, such as revetments for aircraft and personnel shelters, differed widely. Aircraft dispersal, another effective passive protection measure, was limited by the severe restrictions on available ramp parking space. POL and MMS areas were likewise provided with what few revetments and whatever dispersal space was possible under the circumstances. Another example of the varied responses of defense planners was "stand-off" fencing. Designed to shield defensive bunkers from an RPG attack, this concept of defense initiated in early 1972 by 7/13AF SP had yet to be fully implemented at base level by June. Indeed, several bases had hardly begun the project.^{135/}

A series of reports from the bases to COMUSMACTHAI detailed the multi-million dollar impact of upgrading the physical defenses of USAF/Thai bases since 1968. Also, the first attack caused defense planners to realize that adequate base protection required much more than a few armed sentries with rifles walking posts after dark behind a three strand barbed-wire fence.^{136/} However, a fully standardized base defense posture had not yet been attained by mid-1972.

Limitations

Geographic constraints provided many problems in the USAF base defense posture in Thailand. Contiguous population centers at many of the bases severely limited opportunities for both observation and effective counterfire. Further, tropical vegetation aided by seasonal monsoon rains grew almost faster than it could be controlled. Dense jungles were rated as the greatest threat to the defenses at U-Tapao.^{137/} Other natural features such as streams

~~PROF~~

~~CONFIDENTIAL~~

~~NOFORN~~

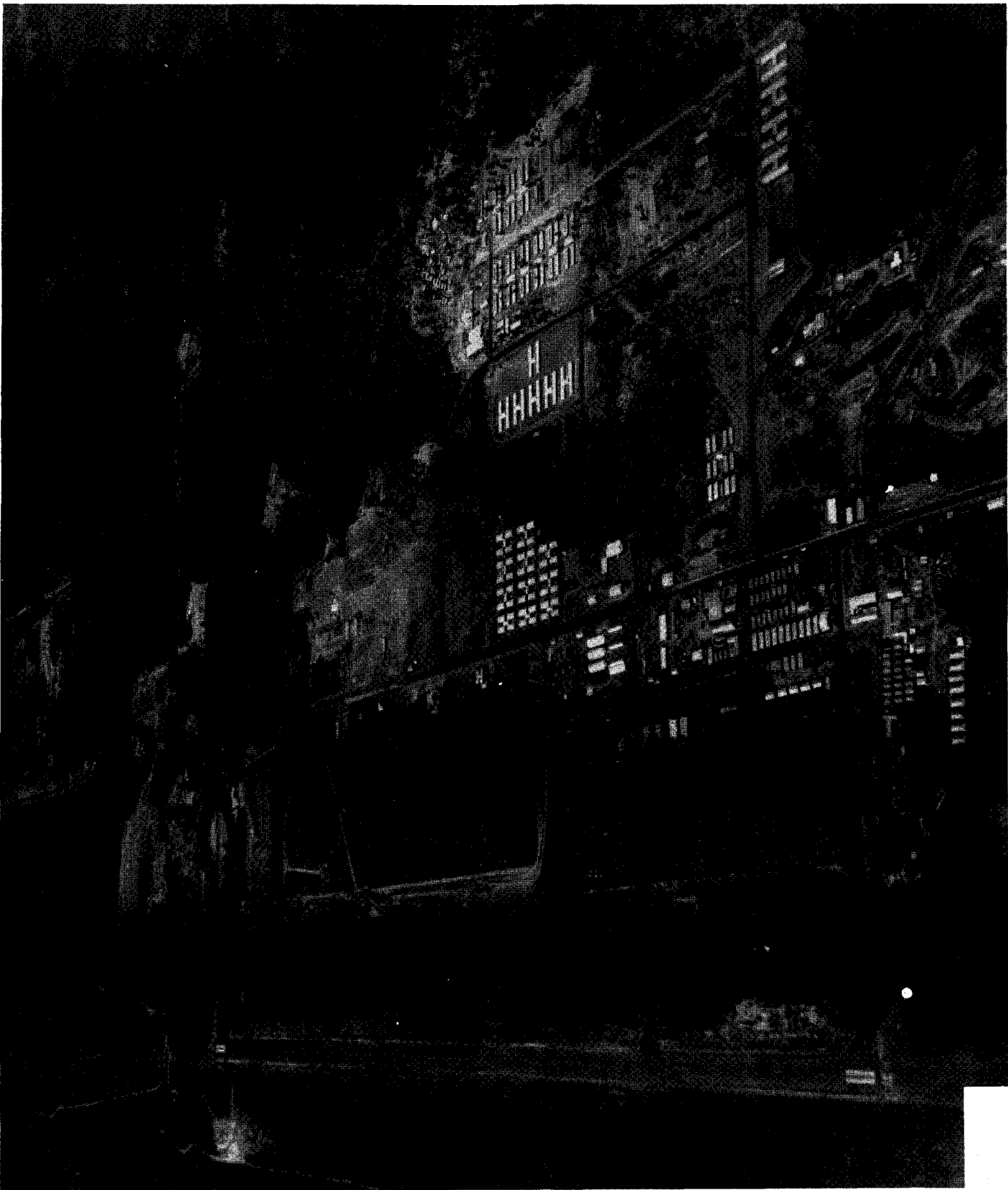

NAKHON PHANOM RTAFB 1966

FIGURE 13

~~CONFIDENTIAL~~

100401

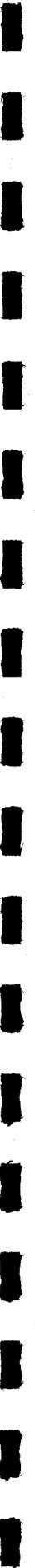

~~CONFIDENTIAL~~

~~NOFORN~~

and drainage ditches, known as "klongs," provided concealment and thus were natural points of entry for enemy sappers. Most bases relied on extra illumination to counter the threat in those areas. The extent to which vegetation has been cleared is graphically illustrated in the case of NKP. The photograph of that base on the following page shows the extent of vegetation inside the base perimeters in the early days of construction when the airfield was carved out of virgin jungle. An interesting comparison between NKP 1966 and NKP 1972 can be made by reference to the picture of that base that appears earlier in this report. (See Figure 6.)

Other constraints were imposed by various economic and political considerations. There was a relative scarcity of resources and money which forced defense planners to establish priorities in the areas of the base they were able to defend in depth. Thus POL and MMS areas had to compete with aircraft, which past experience had shown were more lucrative targets.

Local USAF base commanders' emphasis on defense often varied. For example, prior to the June 1972 attack, the base commander of Ubon RTAFB directed that a triple concertina barrier be removed from an area between aircraft revetments and the base perimeter, just 100 meters beyond. The directive ordering the removal of the fence was part of a current "base beautification" effort. This very area became the penetration point for the sapper attack.^{138/} Occasionally, higher command also diverted defense resources to areas with higher threat estimates. Barbed-tape, considered the most effective anti-penetration barrier available for use along

~~CONFIDENTIAL~~

~~SECRET~~

~~NOFORN~~

perimeters, ^{139/} was scheduled for installation at U-Tapao RTNAF in late 1971. In November, PACAF directed that the tape be held for possible diversion to vulnerable Vietnam bases. ^{140/} Four days after the January 1972 attack, 13AF directed that the tape still at U-Tapao RTNAF be employed in that base's defense. ^{141/} Thirteenth Air Force further indicated that the tape sent to Vietnam would either be replaced or redirected back to U-Tapao. ^{142/}

Construction projects, such as fence barriers, defensive bunkers, and observation towers, frequently had to await the completion of higher-priority civil engineering work orders. The response to this difficulty often was an enormous SP self-help effort. Probably well over 50 percent of all defensive structures in Thailand were constructed solely by security police personnel. Higher headquarters, while commending such vigorous efforts, cautioned the field not to rely exclusively on self-help but to utilize regular Air Force supply and civil engineering channels whenever possible. ^{143/}

The U.S. Embassy's ROE also provided several limitations on physical defenses. The original 1968 ROE prohibited the use of flareships. This was changed in 1969, and flare drops and the use of 81mm mortars were approved for illumination as long as the "trash" didn't impact outside the base. Soil sterilization and herbicide use was also approved in 1969, but these were subject to extensive coordination with local RTG authorities and final permission from the Embassy. They could only be used on areas within the perimeter and under no circumstances could the vegetation control agents be used to clear areas of observation to fire off-base. ^{144/} This lengthy

~~CONFIDENTIAL~~

~~NOFORN~~

process, and the inability to go beyond the fences, significantly limited the use of those agents at many bases. ^{145/}

The 1969 ROE required advance approval of the Ambassador for all "new weapons" introduced into Thailand. ^{146/} This rule was used to limit the previously-discussed, command-detonated pop-up mines. The Embassy limited their installation to the launcher tubes. The actual mines and detonation circuitry could not be installed until a "Yellow" (or higher) Security Alert Condition was in effect. This stricture led CINCPACAF to cancel the planned use of such mines when several efforts to secure fewer limitations from the Embassy proved unsuccessful. ^{147/} Finally, in May 1972, PACAF permission was obtained to undertake a limited test of the mines at U-Tapao, subject to the ROE restrictions. CINCPACAF then requested that Headquarters USAF seek greater freedom in their use and directed that no further bases would be armed until the ROE were modified. ^{148/}

Base Analysis

Korat RTAFB. Vegetation control was a serious problem at this base in 1972, especially in the critical RTAF area near the end of the runway. The dense growth offered opportunity for concealment in the area contiguous to the unrevetted KC-135 parking ramp. Further, vegetation was thick in many sectors of the concertina wire on the perimeter. The base had received Embassy permission to use herbicides and had just begun that program in June.

The perimeter was heavily wired with trip-flares to assist in detecting intruders. Unfortunately, there was no use of NODs despite their availability. Additionally, most of the perimeter observation towers were unusually low and several were set back from the perimeter, thus hindering effective observation of parts of the perimeter lines. Also, in June 1972, the base began the construction of 81mm mortar pits.

Physical protection in the MMS area had the potential of becoming highly effective. Higher towers and adequate fencing surrounded the area; unfortunately, several sections of lights were inoperative because required parts were on back order from supply. Large areas of the defense perimeter were dangerously darkened. ^{149/}

Nakhon Phanom RTAFB. NKP also had the usual rainy season vegetation problems, but heavy use of herbicides kept the growth under control in the fenced areas. Interior vegetation was usually kept closely cut. Lighting around the straight perimeter was excellent and NF-2 Light-All units were placed at the drainage ditches which went through the fences. High observation towers located close to the perimeter afforded excellent visibility at all points.

As previously mentioned, a limited BPS detection system was installed in 1971 around portions of the outer perimeter fence. Full coverage was planned for late 1972. The aircraft on the flight lines were generally

~~CONFIDENTIAL~~

~~NOFORN~~

unrevetted and parked in line, which made them highly vulnerable to a stand-off attack or sabotage. However, the special Task Force Alpha Project, located on the base, was protected by high revetments and was thus impervious to all but direct hits.^{150/}

Takhli RTAFB. When Takhli was reactivated in May 1972, a "bare-base defense" concept was implemented. Designed for locations where defenses were non-existent, the concept envisioned rapid deployment of fully-equipped security personnel. Defense personnel were drawn from the SPECS program and equipment was to have either been brought with the units or supplied from other PACAF resources. Unfortunately, in several cases the SPECS units came without any support equipment and in no case did they bring vehicles or communications equipment. Consequently, they were dependent on PACAF support. Extra equipment was drawn from several bases, including those in Thailand, but the timeliness and quality of the support was frequently less than desirable. For example, several battery chargers for the portable radios were inoperative when received, as was one of the M-60 machine guns.^{151/} Ubon and NKP both sent base communications stations to Takhli, but both were received without any transistors or tubes. The mobile radio unit from Korat was inoperative when received.^{152/}

On 15 May the base defenders, possessing only 15 portable radios, were severely limited due to the communications deficiencies. They received 29 more in early June, but there were over 100 defensive posts to be manned during the critical evening hours. Finally, on 1 July, Takhli received an additional shipment of 220 surplus radios from Vietnam.^{153/}

Recognizing the critical communications problems, 7/13AF SP recommended that all future SPECS planning include four-channel radios in mobility equipment. ^{154/}

Takhli defenses were rebuilt by massive self-help operations using the TDY security forces. However, 13AF staff inspectors reemphasized the same admonition voiced earlier concerning the necessity to coordinate work order requests with Civil Engineering for support in constructing physical defense aids. ^{155/}

The single greatest problem faced by the defense unit was lack of vehicles. There were no tracked M113 armored personnel carriers available for Takhli. This restricted troop deployment during the rainy season. Of the four smaller personnel carriers the SPs had, only one was operative. In mid-June, over 55 percent of the few vehicles available were inoperative due to maintenance difficulties. The defense force had the use of only a few "M" series combat jeeps. However, the wing and base commanders had each indicated command interest in solving this problem by recalling such jeeps from other mission elements on the base. ^{156/}

Since the security forces did not wish to use them, the base made no use of trip-flares in its intrusion detection system. Nor were there any perimeter lights installed as of June, although a proposal had been submitted to 13AF for approval. ^{157/}

Lack of sufficient vehicles and communications equipment in the early days of the defense construction had severely hampered the defense posture.

~~CONFIDENTIAL~~

~~SECRET~~

~~NOFORN~~

Fortunately, that posture was not tested. ^{158/} The greatest remaining problems in June were the inadequate numbers of vehicles and the lack of perimeter lighting.

Ubon RTAFB. In the opinion of the defense personnel at Ubon RTAFB in 1972, the proximity of the perimeter defenses to the primary resources constituted a serious weakness at this base. At the point of penetration in June, the perimeter was less than 300 feet from the AC-130 parking revetments. This area compression limited the effective application of the three-defensive-ring concept and seriously limited the fields of fire. The type of perimeter fences varied; some sections of the fence consisted of two lines of triple concertina wire, while, in other sections, the fence was much less of a barrier.

Lighting on the perimeter was adequate under normal conditions, but heavy rain frequently shorted out large sections of the lights. Back-up Light-All units were in short supply, even during periods of heightened security. Ordinarily, 81mm mortars were available to provide illumination when needed. Unfortunately, observation devices were in short supply, and the base only had 12 NODs available. Four Xenon lights were on the base, but were not used either because the unit or its generator was inoperative, or the special binoculars were not functioning.

A BPS intrusion detection system was programmed for October 1972, and plans had been made to fence the close-in defensive perimeter.

~~CONFIDENTIAL~~

~~SECRET~~ NOFORN

The MMS area, six miles off-base, was defended in-depth with good fighting positions and excellent observation towers. It was probably the most secure MMS area in Thailand. ^{159/}

Ubon had undertaken a unique approach to solve one of its problems, that of controlling off-base vegetation. The ROE prohibited the use of herbicides outside the perimeter, but Base Civic Action undertook the project of having vegetation cleared 100 meters from the MMS area fence and had additionally contracted with local villagers to clear 150 meters of dense underbrush from around the base perimeter. The project was inexpensive, cleared a wide field for observation, and put money into the local villages, thereby helping to create good will. ^{160/}

Udon RTAFB. Udon City abutted a large area of the base, creating detection problems. The perimeter was also very close to the aircraft at several points, denying the defenders the necessary "battle room" to employ the three-defensive-rings technique. Describing the situation there, the chief of security police stated: "Internal defense is inadequate because of the geographic problems. We are just too small!" ^{161/}

Deep drainage canals, or "klongs," created further limitations on the detection ability, but a BPS was scheduled for installation in December 1972 to help alleviate some of those problems.

As previously mentioned, a long section of the perimeter was shared with commercial airlines, specifically, Air America and Continental Airways.

~~CONFIDENTIAL~~

~~NOFORN~~

This section was not defended in-depth, but fencing and some bunkers were present. More active defense of this sector was planned after July.

The POL area was in a corner of the base next to the town. Several of the fuel storage tanks were less than 100 feet from civilian housing. The MMS areas, both off-base, were very small and vulnerable to attack. The interior munitions were revetted, but the openings to several of the revetments faced the fence, greatly limiting the effectiveness of that protection against a RPG attack.

The flight line area was well revetted, but there was little use of wire fencing to give depth to the close-in defenses. ^{162/}

U-Tapao RTNAF. Unlike Udorn and Ubon, which suffered from too little battle space, U-Tapao defenses were almost engulfed by territory. Such a massive amount of real estate forced dilution of both people and resources committed to the defense effort. That dilution contributed to the weaknesses demonstrated in January 1972. However, by June, the defense concepts were altered and the main line of resistance was planned around the middle defensive positions. Construction of physical barriers in this region and installation of lighting still lagged. A BPS was scheduled to ring the close-in aircraft area defenses, the MMS area, and the POL site. Pop-up mines had also been approved for those areas.

The base had another unusual problem. There was a Thai village located on the base inside the perimeter. This created difficulties, especially in pilferage control.

~~CONFIDENTIAL~~

~~NOFORN~~

Vegetation control was all but impossible over the entire reservation. Vegetation control was further hindered by the inability of the base to get herbicides through supply channels during the entire first half of 1972.

Despite the eighteen and one-half miles of perimeter, U-Tapao possessed only six NODs, and of those, only two were operative. The typical vehicle maintenance difficulties also existed.

Essentially, U-Tapao's defenses were being restructured in mid-1972 in response to the lessons learned during the January attack. The plans had been made and the defense forces were occupied in constructing the physical barriers to prevent another penetration attempt by the enemy. ^{163/}

~~CONFIDENTIAL~~

~~NOFORN~~

CHAPTER IV

CONCLUSION

In 1968, air base defense in Thailand was in its infancy. A series of daring sapper attacks over the next four years did much to hasten the evolution of defense concepts that were adapted in the effort to protect vital USAF resources from such surreptitious assaults.

The Director of Security Police, 7/13AF, tasked each base to develop a plan stressing flexibility within certain set standards in preparing their defenses. Although forced to counter the enemy threat from behind static defense lines, base security forces demonstrated positive and innovative thinking in reassessing and strengthening the physical fortifications of the installations. Continuing consideration was given to more effective utilization of the limited personnel and equipment resources available. Various deficiencies existed, but they were recognized, and command concern was focused on their elimination.

If any lag in response to a perceived enemy threat existed, it was in the preparation of effective countermeasures to enemy action other than sapper attacks. Circulation control in flight line, POL, and MMS areas to protect against a sabotage threat was often inadequate. Also, the risk of stand-off attack was not matched by effective defenses. As was observed in Vietnam in 1969, "The stronger USAF internal base defense forces have become, the more the enemy has relied on stand-off attacks, and the

threat of penetration by sapper squads has diminished."^{164/} Unfortunately, the best security against such a threat was beyond the control of the USAF; a vigorous and regular presence by friendly armed forces in areas around the external perimeter of the bases would have provided a powerful deterrent to any hostile activity, but adequate RTG presence was often lacking.

Security for the more obvious aircraft targets was generally good, but in other areas also important to the combat mission, it was often unsatisfactory. This deficiency was commonly justified on the premise that defense resources were limited and "the enemy had never chosen to destroy fuel or munitions before." Of course, history has recorded many attacks that were "the first of their kind." Fortunately, such "reaction-type" planning was the exception and not the rule in Thailand base defense, and the vulnerability of such targets was recognized.

Perhaps the best example of the attitude taken toward security on the Thai bases was stated in late May 1972 by the senior USAF Security Policeman in the country.^{165/}

Prime attention and interest has been rightly focused on base perimeter defense and the capability to detect and deal with hostile forces at this point long before they have a chance to get to vital mission resources. We have, however, at the same time failed in some cases to provide adequate attention and security coverage around and adjacent to vital mission resources. Without jeopardizing our perimeter defense, we must take a close look at the security being provided aircraft and essential mission items. In looking at this problem we must take into consideration factors which limit our control over who comes and goes on base and our resulting lack of knowledge of who may be secluded on

~~CONFIDENTIAL~~

~~SECRET~~

~~NOFORN~~

base at the end of the day. We must also consider penetration of our defense and security through use of subterfuge as well as outright undetected penetration of the perimeter defense. Our circulation control, security coverage and placement of sentries in and around those areas must be such that it insures that we detect and deal with hostile elements before they destroy our resources. We must be as well prepared as our security force, equipment and the situation will permit. . . .

~~SECRET~~

[Illegible text]



[Illegible text]

UNCLASSIFIED

FOOTNOTES

CHAPTER I

1. (S) Interview, Major General Dewitt R. Searles, Deputy Commander 7/13AF, 9 Jun 72. (Hereafter cited: M/G Searles Interview)
2. (S) Ibid.
3. (S) CHECO Report, USAF Posture in Thailand, January-December 1967, Hq PACAF, 25 Mar 69, pp. 5-6.
4. (S) Ibid., p. 7.
5. (S) Ibid., p. 44.
6. (S) Ibid.; (S) CHECO Report, USAF Posture in Thailand, 1966, Hq PACAF, 28 Aug 67; (S) CHECO Draft, "USAF Posture in Thailand 1968-1969," Sep 70.
7. (S) Briefing, subj: "Counter Offensive Air Operations Summary," presented to Mr. Lowenstein and Mr. Moose, U.S. Senate Foreign Relations Committee by Major General Marshall and Lt Colonel Harper, Briefing Division, Hq 7AF, 25 May 72.
8. (U) Newspaper article, "Viet Air Operations to Move to Thai Bases," Bangkok Post, 11 Jun 72.
9. (C) Interview, Lt Colonel William H. Derrington, Director of Security Police, 7/13AF/SP, 11 Jun 72. (Hereafter cited: L/C Derrington 7/13AF Interview)
10. (S) CHECO Report, Counterinsurgency in Thailand, 1966, Hq PACAF, 8 Nov 67. (Hereafter cited: CHECO Report, Thai COIN 1966); (S) CHECO Report, COIN in Thailand, January 1967-December 1968, Hq PACAF, 26 Mar 69. (Hereafter cited: CHECO Report, Thai COIN 67-68); (S) CHECO Report, COIN in Thailand, January 1969-December 1970, 1 Jul 71.
11. (S) CHECO Report, Thai COIN 1966, p. 1.
12. (S) Briefing, presented to Preparedness Investigation Subcommittee of the Senate Committee on Armed Forces by Major General Charles R. Bond, Dep Cmdr, 7/13AF, 2 Nov 66.
13. (S) CHECO Report, Thai COIN 1966, p. 2; (S) CHECO Report, Thai COIN 67-68, p. 12.
14. (S) Ibid.

UNCLASSIFIED

15. (C) Command Briefing, prepared by Dep Cmdr, 7/13AF by Captain John C. Hunt, Ground Combat Intelligence Officer, Directorate of Security Police, 7/13AF/SP, subj: "Ground Combat Intelligence Summary, 1972," 9 Jun 72. (Hereafter cited: 7/13AF Command Intell. Briefing); (S) Report, subj: "Insurgent Threat in Thailand," MACTHAI/JUSGMAGTHAI, 6 Jul 72.

16. (U) Regulation, USMACTHAI/JUSMAGTHAI Regulation 500-5, "Arming of U.S. Military Personnel and Rules of Engagement," 28 Mar 70. (Hereafter cited: MACTHAI Reg 500-5 ROE)

17. (S) CHECO Report, Attack on Udorn, 26 July 1968, Hq PACAF, 27 Dec 68.

18. (S) Report, subj: "Insurgent Attack on Udorn RTAFB, Thailand, 26 July 1968," OSI District 51, reference number 51-68-830, undated, p. 12.

19. (C) Report, subj: "Combat After Actions Report" made to 7/13AF/SP by Major Eugene A. Lamar, Chief of Security Police, 8CSG/SP, 20 Aug 69; (S) Report, subj: "Sapper Attack, Ubon RTAFB, Thailand, 28 July 1969," OSI District 51, reference number 51-69-1168, 5 Aug 69.

20. (S) Msg, subj: "Enemy After Action Report," 8CSG/SP to CINCPACAF/IGS, 280800Z Jul 69.

21. (C) Report, subj: "Combat After Action Report" made to 7/13AF/SP by Captain John R. O'Leary, Chief Security Police, 8CSG/SP, 6 Feb 70. (Hereafter cited: Ubon 1970 Combat After Action Report); (S) Report, subj: "Sapper Attack, Ubon RTAFB, Thailand, 13 January 1970," OSI District 51, reference number 51-70-0018, 22 Jan 70; (S) Msg, subj: "Sapper Attack on Ubon AflD, 13 Jan 70," 8CSG/SP to CINCPACAF, 131110Z Jan 70.

22. (S) Msg, subj: "Ubon Attack, Intelligence Wrap-Up," COMUSMACTHAI to Sec. of State, Washington, D. C., 150800Z Jan 70.

23. (U) Msg, subj: "Sapper Attack," CINCPACAF to 8CSG/SP, 142135Z Jan 70; (C) Msg, subj: "Attack at Ubon RTAFB," Dep Cmdr, 7/13AF to 8CSG/SP, 180700Z Jan 70.

24. (S) Msg, subj: "Enemy Action Report," 635CSG/SP to CINCPACAF/IGS, 101312Z Jan 72; (S) Report, subj: "Combat After Action Report" made to 7/13AF/SP by Major G. B. Stackhouse, Chief of Security Police, 635CSG/SP, 3 Feb 72; (S) Report, subj: "Sapper Attack, U-Tapao Airfield, Thailand, 10 January 1972," OSI District 51, no reference number, no date. (Hereafter cited: OSI U-Tapao Report)

25. (U) Msg, subj: "U-Tapao Attack," Cmdr, 13AF to 635CSG/SP, 130300Z Jan 72; (S) Telegram, subj: "Air Base Intrusion, U-Tapao," U.S. Ambassador Unger to Sec. of State, 10 Jan 72.

UNCLASSIFIED

UNCLASSIFIED

26. (S) Msg, subj: "Sapper Attack on U-Tapao Airfield, 10 January 1972," Dep Cmdr, 7/13AF to Cmdr, 7AF, 102005Z Jan 72.
27. (C) Msg, subj: "Sapper Attack," Chief of Staff, USAF to 635CSG, 111932Z Jan 72; (U) Msg, subj: "Sapper Attack," CINCPACAF to CSAF, 122305Z Jan 72.
28. (S) OSI U-Tapao Report, pp. 21-22.
29. (C) Msg, subj: "Security Police Spot Intelligence Report 71-3," 8CSG/SP to 7/13AF/SP 020600Z Jun 72.
30. (S) Msg, subj: "Enemy Action Report," 8CSG/SP to CINCPACAF/IGS, 041240Z Jun 72; (S) Msg, subj: "Ubon Spot Intelligence Report 72-4," 8CSG/SP to 7/13AF/SP, 030900Z Jun 72.
31. (C) Msg, subj: "Sapper Attack," Cmdr, 8TFW to 7/13AF/DO, 040115Z Jun 72.
32. (C) 7/13AF Command Intell. Briefing.
33. (C) L/C Derrington 7/13AF Interview; (S) M/G Searles Interview.
34. (C) Msg, subj: "Air Base Intelligence Summary," Communist Suppression Command (RTG) to 7/13AF/SP, 090310Z Jun 72.
35. (C) Msg, subj: "Air Base Defense Intelligence Summary," Communist Suppression Command (RTG) to 7/13AF/SP, 160745Z Jun 72.
36. (C) Report, subj: "Vietnamese Refugees in Thailand: Fund Collection Activities," OSI District 51, reference number 1-656-0023-72, 20 Mar 72.
37. (C) Report, subj: "Communist Forces in Thailand: Infiltration by North Vietnamese Army Officers," OSI District 51, reference number 1-656-0029-72, 3 Apr 72.
38. (C) Msg, subj: "Spot Report 114-72," Det II, Army Advisory Group to COMUSMACTHAI, 060328Z Jun 72.
39. (C) L/C Derrington 7/13AF Interview.
40. (C) Msg, subj: "Nakhon Phanom Spot Report 3-72," 56CSG/SP to 7/13AF/SP, 010630Z Jun 72 (date error, should be Jul).
41. (S) M/G Searles Interview.
42. (S) Study, subj: "Air Base Defense," prepared by Major M. F. Allington, Air Base Defense Advisor, AFAT-5, Tan Son Nhut Airfield, 1 Jun 71.

UNCLASSIFIED

UNCLASSIFIED

43. (C) L/C Derrington 7/13AF Interview; (C) Msg, subj: "Weekly Intelligence Summary," 7/13AF/SP to all Thai Bases, 130639Z Jun 72.
44. (S) Msg, subj: "Insurgent Situation in Thailand," CINCPAC to CINCPACAF, 160412Z Jun 72.
45. (S) Msg, subj: "Insurgent Situation in Thailand," Chairman, Joint Chiefs of Staff to CINCPAC, CINCPACAF, 160413Z Jun 72.

CHAPTER II

46. (C) 7/13AF Command Intell. Briefing.
47. (C) Interview, Major A. E. Medsker, Chief of Security Police, 8CSG/SP Ubon RTAFB, 18 Jun 72. (Hereafter cited: Maj Medsker Ubon Interview)
48. (C) Interview, Capt John S. Campbell, Operations Officer, 432 SPS Udorn RTAFB, 12 Jun 72.
49. (U) Contract, #AF62(272)272, subj: "Thai Security Guard Contract," entered into by COMUSMACTHAI and the Thai Supreme Command Headquarters, Royal Thai Ministry of Defense, 1 Feb 66.
50. (C) Memo, subj: "Security Guard Regiment Administration and Command," Air Chief Marshal Dawee, Supreme Commander, Thai Supreme Headquarters to all RTAF bases, reference number KH 0312/6164, 4 Sep 66.
51. (S) CHECO Report, 7AF Local Base Defense Operations, July 1965-December 1968, Hq PACAF, 1 Jul 69. (Hereafter cited: CHECO Report, RVN 65-68 Base Defense)
52. (U) Ltr, subj: "Thai Security Guards," 7/13AF/SP to all base SPSs, 7 Jun 72.
53. (C) Msg, subj: "Thai Security Regiment Commander's Message #265/15 dated 10 June 1972," 7/13AF/SP to COMUSMACTHAI/J-36, 131015Z Jun 72; (C) Msg, subj: "Insurgent Situation in Thailand," 7/13AF/SP to CINCPACAF/IGS, 280955Z Jun 72.
54. (C) 7/13AF Command Intell. Briefing.
55. (C) Msg, subj: "Sapper Attack," Cmdr 8TFW to 7/13AF/DO, 040115Z Jun 72.
56. (C) L/C Derrington 7/13AF Interview.

UNCLASSIFIED

UNCLASSIFIED

57. (C) Ibid.; (C) Interview, TSgt Robert A. Van deRiet, senior K-9 Trainer in Thailand, 56SPS, Nakhon Phanom RTAFB, 14 Jun 72.
58. (C) Ibid.
59. (S) CHECO Report, RVN 65-68 Base Defense.
60. (C) Msg, subj: "Air Base Defense Posture," Det II, Army Advisory Group to COMUSMACTHAI, 121555Z Feb 72; (C) Msg, subj: "Insurgent Situation in Thailand," 7/13AF/SP to CINCPACAF, 280955Z Jun 72.
61. (C) Ltr, no subject, Cmdr 7/13AF to COMUSMACTHAI, 6 Jun 72.
62. (C) Memo, subj: "Base Defense, Joint Thai/U.S. Bases," 7/13AF/SP to Dep Cmdr, 7/13AF, 15 May 72.
63. (S) M/G Searles Interview.
64. (C) Memo, subj: "Policy Guidelines for U.S. Military Assistance to Thai Counterinsurgency Efforts," U.S. Embassy Bangkok to Dep Cmdr, 7/13AF, 2 May 68; (C) MACTHAI Reg 500-5 ROE.
65. (C) Ubon 1970 Combat After Action Report.
66. (S) CHECO Report, RVN 65-68 Base Defense, Chapter IV, "Operation Safe Side."
67. (C) Memo, subj: "Mission Policy on Base Defense," para II F, COMUSMACTHAI/JUSGMAGTHAI to 7/13AF, 1 Nov 69; (C) Memo, subj: "Mission Policy on Base Defense," para II F, II G, Minister/Counselor for Counterinsurgency, U.S. Embassy, Bangkok to COMUSMACTHAI and Dep Cmdr, 7/13AF, 4 Mar 70. (Hereafter cited: Embassy 1970 ROE)
68. (U) Regulation, AFR 125-32, subj: "Security Police Elements for Contingencies (SPECS)," date unknown, c.72; (U) Regulation, (draft 8 June 1972), PACAFR 125-XX, subj: "Security Police Elements for Contingencies (SPECS)," proposed publication date: 15 Jul 72.
69. (TS) CHECO Draft, "The USAF Response to the Spring 1972 NVN Offensive: Situation and Deployment," 9 Sep 72. (Material extracted from this report was classified no higher than Secret.)
70. (C) L/C Derrington 7/13AF Interview.
71. (C) Ibid.; (C) Interview, Captain Gregory L. Smith, Acting Chief of Security Police, 366 SPS, Takhli RTAFB, 1 Jul 72. (Hereafter cited: Capt Smith Takhli Interview)

UNCLASSIFIED

UNCLASSIFIED

72. (U) Ltr, subj: "Security Police Elements for Contingencies (SPECS)," PACAF/IGS to 5AF/IGS, 13AF/IGS and 15ABWg/SP, 30 May 72.
73. (C) 7/13AF Command Intell. Briefing.
74. (C) L/C Derrington 7/13AF Interview.
75. (C) Ltr, subj: "Mission Policy on Base Defense," (contains U.S. Embassy directive on same subject) USMACTHAI/JUSMAGTHAI to 7/13AF, 1 Nov 69. (Hereafter cited: Embassy 1969 ROE)
76. (S) M/G Searles Interview; (C) L/C Derrington 7/13AF Interview.
77. (S) Memo, subj: "U.S. Mission Policy Guidelines for U.S. Counter-insurgency Support in Thailand," SA/CI, U.S. Embassy, Bangkok, to COMUSMACTHAI and 7/13AF, 4 Mar 68. (Hereafter cited: Embassy 1968 ROE)
78. (S) Ibid.
79. (S) Embassy 1969 ROE.
80. (C) Embassy 1970 ROE.
81. (C) MACTHAI Reg 500-5 ROE.
82. (C) Ltr, subj: "Mission Policy on Base Defense," (containing an addendum from the U.S. Embassy to its Policy Directive) COMUSMACTHAI/JUSMAGTHAI to 7/13AF.
83. (C) Ibid., footnotes 76, 78-83.
84. (U) Manual, PACAFM 207-25, subj: "Security Policy and Guidance for Guerrilla/Insurgency/Limited War Environments," PACAF, 15 Feb 71. (Hereafter cited: PACAFM 207-25) 13AF Supplement 1 thereto, 25 Mar 71.
85. (S) M/G Searles Interview; (C) L/C Derrington 7/13AF Interview.
86. (U) PACAFM 207-25.
87. (U) Report, subj: "Quarterly Security Police Report," 388 SPS to 7/13AF, 30 Mar 72.

UNCLASSIFIED

UNCLASSIFIED

88. (C) Interview, Major John W. Gordon, Chief Security Police, 388 SPS, Korat RTAFB, 28 Jun 72. (Hereafter cited: Maj Gordon Korat Interview); (U) Msg, subj: "Security of Installations," 388 SPS to COMUSMACTHAI 300610Z May 72. (Hereafter cited: Korat Security Msg); (C) Msg, subj: "Air Base Defense Posture," Det II, ARAG to COMUSMACTHAI, 121555Z Feb 72. (Hereafter cited: Air Base Defense Posture Msg); (C) Ltr, subj: "Results of Exercise," Colonel Jugchai, Chief of Staff, 2d Army, RTA to CSP, 388 SPS, 27 Jan 72; (C) Operational Order #73/2514, Cmdr, Hq Provincial Police Region 3, subj: "Scouting for Air Base Defense," 21 Apr 71; (C) Operational Order 1/2814 RTA, Major General Chamlong, Cmdr 2d Army, RTA, subj: "Combined Area and Security and Defense Plan," 30 Apr 69.
89. (C) Ltr, subj: "Providing RTAF Security Patrols," reference MO 0382/6571, Cmdr, Wing III, RTAF to 388 CSG, 27 May 71.
90. (C) Major Gordon Korat Interview; (C) Interview and day/night tour of facilities by author and Captain Armin A. Krueger, Operations Officer, 388 SPS, Korat RTAFB, 27 Jun 72. (Hereafter cited: Korat Inspection)
91. (C) Ibid.
92. (C) Ibid.
93. (U) Memo, subj: "Letter of Understanding Between III Wing, RTAF and 388 CSG/SP," undated, (Jun 70); (U) Ltr, subj: "Access Control Procedures," Colonel C. C. Mish, Cmdr, 388 TFW to Cmdr, III Wing, RTAF, 10 Jul 71.
94. (C) Plan, subj: "Base Defense Security Plan," reference MO -382/119, 1 Jul 71; (C) Air Base Defense Posture Msg; (C) Msg, subj: "Security of Installations Occupied by U.S. Forces in Thai," 56 SPS to COMUSMACTHAI, 290920Z May 72. (Hereafter cited: NKP Security Msg); (U) History, "56 SPS, 1 March 1972-31 March 1972," 8 Apr 72.
95. (C) Ibid., Air Base Defense Posture Msg; (C) Interview, Major James S. Barger, Chief of Security Police, 56 SPS, Nakhon Phanom RTAFB, 14 Jun 72. (Hereafter cited: Maj Barger NKP Interview)
96. (C) Maj Barger NKP Interview.
97. (C) Ibid.; (C) Interview and day/night tour of facilities by author and Captain Fred Riccardi, Operations Officer, 56 SPS, NKP RTAFB, 14 and 15 Jun 72. (Hereafter cited: NKP Inspection)
98. (C) Capt Smith Takhli Interview.
99. (C) Msg, subj: "Constant Guard III," 13AF/IGS to 7/13AF/SP, 110845Z May 72; (C) Msg, subj: "Joint Defense Plans," 6499 (Provisional) SPS to 13AF/IGS, 110202Z Jun 72.

UNCLASSIFIED

100. (C) Capt Smith Takhli Interview.
101. (C) Ibid.
102. (U) Report, subj: "Bi-Monthly Security Police Manning Report," 8 SPS to 7/13AF/SP, 1 Jun 72.
103. (C) Interview, Lt Colonel Robert J. Foy, Chief of Security Police, 8 SPS, Ubon RTAFB, 18 Jun 72. (Hereafter cited: L/C Foy Ubon Interview); (C) Maj Medsker Ubon Interview; (U) Ltr, subj: "Security of Installations Occupied by U.S. Forces in Thailand," 8 SPS to COMUSMACTHAI, 4 Jun 72. (Hereafter cited: Ubon Security Msg)
104. (C) L/C Foy Ubon Interview.
105. (C) Interview and day/night tour of facilities by author and L/C Foy, CSP, 8SPS, Ubon RTAFB, 18 Jun 72. (Hereafter cited: Ubon Inspection)
106. (C) Ltr, subj: "Base Defense," Major General Searles to Cmdr, 432TRW, Udorn RTAFB, 8 Oct 71.
107. (S) Msg, subj: "Base Defense," 7/13AF/SP to all Thai Bases, 290935Z Jan 72.
108. (C) Interview, Major Kenneth J. Kwiatkoski, Chief of Security Police, 432 SPS, Udorn RTAFB, 13 Jun 72. (Hereafter cited: Maj Kwiatkoski Udorn Interview); (S) Plan, subj: "Joint Base Defense Plan," reference Tactical Ops Plan 9/305 UMD, 2d Regimental Army, RTA, May 72.
109. (C) Air Base Defense Posture Msg.
110. (C) Msg, subj: "POL for Joint Defense Plans," 13AF to COMUSMACTHAI, 100700Z Jan 72.
111. (C) Msg, subj: "Thai Reaction to Udorn Alert," Cmdr, ARAG to COMJUSMAGTHAI, 10 unk Z Jan 72.
112. (C) Interview and tour of facilities by author and Captain John S. Campbell, Operations Officer, 432 SPS, Udorn RTAFB, 12 Jun 72. (Hereafter cited: Udorn Inspection)
113. (C) Ltr, subj: "Base Defense," 432 SPS to Cmdr, 432 TRW, 10 Sep 71.
114. (C) Ibid.
115. (C) Udorn Inspection.
116. (C) Ibid.

UNCLASSIFIED

117. (C) Interview and day/night tour of facilities by author and Captain Brian Y. Shiroyama, Operations Officer, 635 SPS, U-Tapao RTNAF, 20-21 Jun 72. (Hereafter cited: U-Tapao Inspection); (U) Msg, subj: "Security of Installations Occupied by U.S. Forces in Thailand," 635 SPS to COMUSMACTHAI, 290330Z May 72. (Hereafter cited: U-Tapao Security Msg); (C) Interview, Major James E. Strayer, Chief of Security Police, 635 SPS, U-Tapao RTNAF, 21 Jun 72. (Hereafter cited: Maj Strayer U-Tapao Interview)
118. (S) Msg, subj: "Insurgent Situation in Thailand," 635 SPS to 7/13AF/SP, 080700Z Jul 72.
119. (C) Ibid.; (C) Maj Strayer U-Tapao Interview; (C) U-Tapao Inspection.
120. (C) Maj Strayer U-Tapao Interview.
121. (C) U-Tapao Inspection
122. (C) Maj Strayer U-Tapao Interview.

CHAPTER III

123. (S) CHECO Report, RVN 65-68 Base Defense; (C) CHECO Report, Local Base Defense in RVN, January 1969-June 1971, Hq PACAF, 14 Sep 71. (Hereafter cited: CHECO Report: RVN 69-71 Base Defense)
124. (C) Maj Barger NKP Interview.
125. (U) Contract Proposal, subj: "A Proposal to USDAF/AFSC for Installation and Maintenance of Sensor Array," Westinghouse Corp to Dept of Defense, undated, 70; (C) Report, subj: "Safe Look/Have Levy" 56 SPS to Air Base Defense Program Office, Hanscom Field, AFSC, 28 May 72.
126. (C) NKP Inspection.
127. (U) PACAFM 207-25.
128. (C) Maj Strayer U-Tapao Interview; (C) L/C Foy Ubon Interview.
129. (C) Ibid.; (C) Capt Smith Takhli Interview.
130. (C) Embassy 1970 ROE.

UNCLASSIFIED

UNCLASSIFIED

131. (C) Msg, subj: "A/E 25P-1 Pop-Up Mines," 7/13AF to 635 SPS, 300030Z Nov 70; (C) Msg, subj: "Employment Instructions," 13AF to 635 SPS, 110100Z Jan 71.
132. (C) Msg, subj: "A/E 25P-1 Pop-Up Mines," CINCPACAF to Chief of Staff, USAF, 130050Z May 72.
133. (C) Embassy 1970 ROE; (U) MACTHAI Reg 500-5 ROE.
134. (C) U-Tapao Inspection; (C) Maj Medsker Ubon Interview; (C) Maj Barger NKP Interview.
135. (U) Msg, subj: "Interim Change to PACAFM 207-25: Stand-Off Fencing," CINCPACAF to 13AF/IGS, 242016Z Mar 72.
136. (C) Korat Security Msg; (C) NKP Security Msg; (C) Ubon Security Msg; (C) Udorn Security Msg; (C) U-Tapao Security Msg.
137. (C) Maj Strayer U-Tapao Interview.
138. (C) L/C Foy Ubon Interview.
139. (U) Msg, subj: "30 Inch Barbed Tape," AFLC, Hanscom Field to CINCPACAF/IGS, 081557Z Nov 71.
140. (U) Msg, subj: "30 Inch Barbed Tape," CINCPACAF to 13AF/IGS, 032307Z Nov 71; (U) Msg, subj: "30 Inch Barbed Tape," 13AF/IGS to 635 SPS, 100206Z Nov 71.
141. (U) Msg, subj: "General Purpose Tape Barbed Obstacle," 13AF to CINCPACAF/IGS and 635 SPS, 140740Z Jan 72.
142. (U) Msg, subj: "30 Inch Barbed Tape," 13AF/IGS to 635 SPS, 020400Z Feb 72.
143. (C) Ltr, subj: "Base Defense/Security Programs," Director, Security Police, 7/13AF/SP to all base Chiefs of Security Police, 28 May 72.
144. (C) Embassy 1968 ROE; (C) Embassy 1969 ROE.
145. (C) Maj Strayer U-Tapao Interview.
146. (C) Embassy 1969 ROE.
147. (S) Msg, subj: "A/E 25P-1 Pop-Up Mines," CINCPACAF to 13AF, 250810Z Apr 72; (C) Msg, subj: "A/E 25P-1 Pop-Up Mines," 13AF to 7/13AF/SP, 250810Z Apr 72.

UNCLASSIFIED

UNCLASSIFIED

148. (S) Msg, subj: "A/E 25P-1 Pop-Up Mines," CINCPACAF to CSAF/IGS, 130050Z May 72.
149. (C) Maj Gordon Korat Interview; (C) Korat Inspection.
150. (C) Maj Barger NKP Interview; (C) NKP Inspection.
151. (C) Msg, subj: "Deployment of Equipment," 13AF to 7/13AF, 170800Z May 72.
152. (C) Msg, subj: "Equipment Deficiencies," 6499(P)SPS to 13AF, 270745Z May 72.
153. (C) Msg, subj: "Takhli Defenses," 49 SPS to 13AF, 141625Z May 72.
154. (C) Msg, subj: "Security Police for Contingencies (SPECS)," 7/13AF/SP to 13AF/IGS, 300700Z Jun 72.
155. (S) Msg, subj: "Result of Staff Visit," 13AF/IGS to 6499(P)SPS, 050501Z Jun 72.
156. (U) Briefing, subj: "Defense Posture," Presented to Cmdr, 366 TFW, and Cmdr, 366 CSG by Captain Smith, Chief of Security Police, 366 SPS, Tkahli RTAFB, 1 Jul 72.
157. (U) Ibid.
158. (S) Msg, subj: "Facilities and Equipment," 6499(P)SPS to 13AF/IGS, 150852Z Jun 72.
159. (C) L/C Foy Ubon Interview; (C) Ubon Inspection.
160. (U) Minutes, subj: "Quarterly Base Defense Council Meeting," Ubon RTAFB, 19 Jun 72.
161. (C) Maj Kwiatkoski Udorn Interview.
162. (C) Udorn Inspection.
163. (C) Maj Strayer U-Tapao Interview; (C) U-Tapao Inspection.

CHAPTER IV

164. (S) CHECO Report: RVN 65-68 Base Defense.
165. (C) Ltr, subj: "Base Defense/Security Programs," Lt Colonel Derrington, Director of Security Police, 7/13AF/SP to all Thai bases, 28 May 72.

UNCLASSIFIED

[The page contains extremely faint and illegible text, likely bleed-through from the reverse side of the document. The text is scattered across the page and cannot be transcribed accurately.]



UNCLASSIFIED

GLOSSARY

| | |
|----------------|---|
| APC | Armored Personnel Carrier |
| ARAG | Army Advisory Group |
| Baht | Unit of Thai Currency, Approximate Value of \$.05 |
| BDSC | Base Defense Security Center, Joint |
| BPP | Thai Border Police Patrol |
| BPS | Balanced Pressure System Intrusion Detection Device |
| CINCPAC | Commander-in-Chief, Pacific Command |
| CINCPACAF | Commander-in-Chief, Pacific Air Force |
| COIN | Counterinsurgency |
| COMUSMACTHAI | Commander, U.S. Military Assistance Command, Thailand |
| CONSTANT GUARD | Code Name for Deployment Operations in Spring 1972 |
| CSAG | Counteroffensive |
| CSC | Chief of Staff of the Air Force |
| CSG | Central Security Control, Security Police |
| CSP | Combat Support Group |
| CT | Chief of Security Police |
| | Communist Terrorist |
| FWMF | Free World Military Forces |
| GCI | Ground Combat Intelligence, Security Police |
| Hq | Headquarters |
| IGS | Director of Security Police |
| JCS | Joint Chiefs of Staff |
| JUSMAGTHAI | Joint U.S. Military Advisory Group, Thailand |
| km | Kilometer |
| K-9 | Sentry Dog |
| MACTHAI | Military Assistance Command, Thailand |
| MMS | Munitions Maintenance and Storage |
| NCO | Non-Commissioned Officer |
| NOD | Night Observation Device |
| NKP | Nakhon Phanom Royal Thai Air Force Base |
| NVA | North Vietnamese Army |
| OSI | Office of Special Investigations, USAF |

UNCLASSIFIED

UNCLASSIFIED

| | |
|-----------|---|
| QRT | Quick Reaction Team |
| RAM | Rocket, Artillery, and Mortar |
| ROE | Rules of Engagement |
| RPG | Rocket Propelled Grenade |
| RTA | Royal Thai Army |
| RTAF | Royal Thai Air Force |
| RTAFB | Royal Thai Air Force Base |
| RTARF | Royal Thai Air Reserve Force |
| RTG | Royal Thai Government |
| RTN | Royal Thai Navy |
| RTNAF | Royal Thai Navy Airfield |
| RTNM | Royal Thai Navy Marines |
| SAF | Special Actions Force |
| Safe Side | Code name for Combat Security Police Squadrons |
| SAT | Security Alert Team |
| SEA | Southeast Asia |
| SP | Security Police |
| SPS | Security Police Squadron |
| SPECS | Security Police Elements for Contingencies |
| Stand-off | Rocket or Mortar Attack from the Exterior of the Base |
| TDY | Temporary Duty |
| TPP | Thai Provincial Police |
| TSG | Thai Security Guard |
| USA | United States Army |
| USAF | United States Air Force |
| 7AF | Hq. Seventh Air Force, Tan Son Nhut Air Base, RVN |
| 7/13AF | Hq. Seventh/Thirteenth Air Force, Udorn RTAFB, Thailand |
| 13AF | Hq. Thirteenth Air Force, Clark Air Base, PI |

UNCLASSIFIED