



---

## Uploaded to VFC Website

▶▶ July 2013 ◀◀

---

This Document has been provided to you courtesy of Veterans-For-Change!

Feel free to pass to any veteran who might be able to use this information!

For thousands more files like this and hundreds of links to useful information, and hundreds of "Frequently Asked Questions, please go to:

[Veterans-For-Change](http://Veterans-For-Change.com)

---

*Veterans-For-Change is a 501(c)(3) Non-Profit Corporation  
Tax ID #27-3820181*

***If Veteran's don't help Veteran's, who will?***

We appreciate all donations to continue to provide information and services to Veterans and their families.

[https://www.paypal.com/cgi-bin/webscr?cmd=\\_s-xclick&hosted\\_button\\_id=WGT2M5UTB9A78](https://www.paypal.com/cgi-bin/webscr?cmd=_s-xclick&hosted_button_id=WGT2M5UTB9A78)

---

**Note:**

VFC is not liable for source information in this document, it is merely provided as a courtesy to our members.



**TOXICOLOGICAL PROFILE FOR  
CHLOROFORM**

**U.S. DEPARTMENT OF HEALTH AND HUMAN SERVICES  
Public Health Service  
Agency for Toxic Substances and Disease Registry**

September 1997

**DISCLAIMER**

The use of company or product name(s) is for identification only and does not imply endorsement by the Agency for Toxic Substances and Disease Registry.

**UPDATE STATEMENT**

A Toxicological Profile for chloroform was released in April 1993. This edition supersedes any previously released draft or final profile.

Toxicological profiles are revised and republished as necessary, but no less than once every three years. For information regarding the update status of previously released profiles, contact ATSDR at:

Agency for Toxic Substances and Disease Registry  
Division of Toxicology/Toxicology Information Branch  
1600 Clifton Road NE, E-29  
Atlanta, Georgia 30333



## FOREWORD

This toxicological profile is prepared in accordance with guidelines\* developed by the Agency for Toxic Substances and Disease Registry (ATSDR) and the Environmental Protection Agency (EPA). The original guidelines were published in the *Federal Register* on April 17, 1987. Each profile will be revised and republished as necessary.

The ATSDR toxicological profile succinctly characterizes the toxicologic and adverse health effects information for the hazardous substance described therein. Each peer-reviewed profile identifies and reviews the key literature that describes a hazardous substance's toxicologic properties. Other pertinent literature is also presented, but is described in less detail than the key studies. The profile is not intended to be an exhaustive document; however, more comprehensive sources of specialty information are referenced.

The focus of the profiles is on health and toxicologic information; therefore, each toxicological profile begins with a public health statement that describes, in nontechnical language, a substance's relevant toxicological properties. Following the public health statement is information concerning levels of significant human exposure and, where known, significant health effects. The adequacy of information to determine a substance's health effects is described in a health effects summary. Data needs that are of significance to protection of public health are identified by ATSDR and EPA.

Each profile includes the following:

- (A) The examination, summary, and interpretation of available toxicologic information and epidemiologic evaluations on a hazardous substance to ascertain the levels of significant human exposure for the substance and the associated acute, subacute, and chronic health effects;
- (B) A determination of whether adequate information on the health effects of each substance is available or in the process of development to determine levels of exposure that present a significant risk to human health of acute, subacute, and chronic health effects; and
- (C) Where appropriate, identification of toxicologic testing needed to identify the types or levels of exposure that may present significant risk of adverse health effects in humans.

The principal audiences for the toxicological profiles are health professionals at the Federal, State, and local levels; interested private sector organizations and groups; and members of the public.

This profile reflects ATSDR's assessment of all relevant toxicologic testing and information that has been peer-reviewed. Staff of the Centers for Disease Control and Prevention and other Federal scientists have also reviewed the profile. In addition, this profile has been peer-reviewed by a nongovernmental panel and was made available for public review. Final responsibility for the contents and views expressed in this toxicological profile resides with ATSDR.



David Satcher, M.D., Ph.D.  
Administrator  
Agency for Toxic Substances and  
Disease Registry

### \*Legislative Background

The toxicological profiles are developed in response to the Superfund Amendments and Reauthorization Act (SARA) of 1986 (Public Law 99-499) which amended the Comprehensive Environmental Response, Compensation, and Liability Act of 1980 (CERCLA or Superfund). This public law directed ATSDR to prepare toxicological profiles for hazardous substances most commonly found at facilities on the CERCLA National Priorities List and that pose the most significant potential threat to human health, as determined by ATSDR and the EPA. The availability of the revised priority list of 275 hazardous substances was announced in the *Federal Register* on April 29, 1996 (61 FR 18744). For prior versions of the list of substances, see *Federal Register* notices dated April 17, 1987 (52 FR 12866); October 20, 1988 (53 FR 41280); October 26, 1989 (54 FR 43619); October 17, 1990 (55 FR 42067); October 17, 1991 (56 FR 52166); October 28, 1992 (57 FR 48801); and February 28, 1994 (59 FR 9486). Section 104(i)(3) of CERCLA, as amended, directs the Administrator of ATSDR to prepare a toxicological profile for each substance on the list.

## **CONTRIBUTORS**

### **CHEMICAL MANAGER(S)/AUTHORS(S):**

Selene Chou, Ph.D.  
ATSDR, Division of Toxicology, Atlanta, GA

Wayne Spoo, D.V.M., D.A.B.T.  
Research Triangle Institute,  
Research Triangle Park, NC

### **THE PROFILE HAS UNDERGONE THE FOLLOWING ATSDR INTERNAL REVIEWS:**

1. **Green Border Review.** Green Border review assures consistency with ATSDR policy.
2. **Health Effects Review.** The Health Effects Review Committee examines the health effects chapter of each profile for consistency and accuracy in interpreting health effects and classifying end points.
3. **Minimal Risk Level Review.** The Minimal Risk Level Workgroup considers issues relevant to substance-specific minimal risk levels (MRLs), reviews the health effects database of each profile, and makes recommendations for derivation of MRLs.





## PEER REVIEW

A peer review panel was assembled for chloroform. The panel consisted of the following members:

1. Dr. Richard Bull, Senior Staff Scientist, Battelle Pacific Northwest Laboratories, Richland, Washington;
2. Dr. Derek Hodgson, Provost and Vice-president, Academic Affairs, Mississippi State University, Mississippi State, Mississippi; and
3. Dr. Nancy Reiches, Private Consultant, Bexley, Ohio.

These experts collectively have knowledge of chloroform's physical and chemical properties, toxicokinetics, key health end points, mechanisms of action, human and animal exposure, and quantification of risk to humans. All reviewers were selected in conformity with the conditions for peer review specified in Section 104(i)(13) of the Comprehensive Environmental Response, Compensation, and Liability Act, as amended.

Scientists from the Agency for Toxic Substances and Disease Registry (ATSDR) have reviewed the peer reviewers' comments and determined which comments will be included in the profile. A listing of the peer reviewers' comments not incorporated in the profile, with a brief explanation of the rationale for their exclusion, exists as part of the administrative record for this compound. A list of databases reviewed and a list of unpublished documents cited are also included in the administrative record.

The citation of the peer review panel should not be understood to imply its approval of the profile's final content. The responsibility for the content of this profile lies with the ATSDR.



## CONTENTS

FOREWORD .....	v
CONTRIBUTORS .....	vii
PEER REVIEW .....	ix
LIST OF FIGURES .....	xv
LIST OF TABLES .....	xvii
1. PUBLIC HEALTH STATEMENT .....	1
1.1 WHAT IS CHLOROFORM? .....	1
1.2 WHAT HAPPENS TO CHLOROFORM WHEN IT ENTERS THE ENVIRONMENT? ..	2
1.3 HOW MIGHT I BE EXPOSED TO CHLOROFORM? .....	3
1.4 HOW CAN CHLOROFORM ENTER AND LEAVE MY BODY? .....	4
1.5 HOW CAN CHLOROFORM AFFECT MY HEALTH? .....	4
1.6 IS THERE A MEDICAL TEST TO DETERMINE WHETHER I HAVE BEEN EXPOSED TO CHLOROFORM? .....	6
1.7 WHAT RECOMMENDATIONS HAS THE FEDERAL GOVERNMENT MADE TO PROTECT HUMAN HEALTH? .....	6
1.8 WHERE CAN I GET MORE INFORMATION? .....	8
2. HEALTH EFFECTS .....	9
2.1 INTRODUCTION .....	9
2.2 DISCUSSION OF HEALTH EFFECTS BY ROUTE OF EXPOSURE .....	9
2.2.1 Inhalation Exposure .....	11
2.2.1.1 Death .....	11
2.2.1.2 Systemic Effects .....	12
2.2.1.3 Immunological and Lymphoreticular Effects .....	40
2.2.1.4 Neurological Effects .....	41
2.2.1.5 Reproductive Effects .....	42
2.2.1.6 Developmental Effects .....	43
2.2.1.7 Genotoxic Effects .....	44
2.2.1.8 Cancer .....	44
2.2.2 Oral Exposure .....	45
2.2.2.1 Death .....	45
2.2.2.2 Systemic Effects .....	46
2.2.2.3 Immunological and Lymphoreticular Effects .....	90
2.2.2.4 Neurological Effects .....	91
2.2.2.5 Reproductive Effects .....	92
2.2.2.6 Developmental Effects .....	93
2.2.2.7 Genotoxic Effects .....	94
2.2.2.8 Cancer .....	95
2.2.3 Dermal Exposure .....	97
2.2.3.1 Death .....	97
2.2.3.2 Systemic Effects .....	97

2.2.3.3	Immunological and Lymphoreticular Effects	100
2.2.3.4	Neurological Effects	100
2.2.3.5	Reproductive Effects	100
2.2.3.6	Developmental Effects	100
2.2.3.7	Genotoxic Effects	100
2.2.3.8	Cancer	100
2.3	TOXICOKINETICS	100
2.3.1	Absorption	101
2.3.1.1	Inhalation Exposure	101
2.3.1.2	Oral Exposure	102
2.3.1.3	Dermal Exposure	104
2.3.2	Distribution	105
2.3.2.1	Inhalation Exposure	105
2.3.2.2	Oral Exposure	107
2.3.2.3	Dermal Exposure	107
2.3.3	Metabolism	108
2.3.4	Elimination and Excretion	112
2.3.4.1	Inhalation Exposure	112
2.3.4.2	Oral Exposure	113
2.3.4.3	Dermal Exposure	113
2.3.5	Physiologically Based Pharmacokinetic (PBPK)/Pharmacodynamic (PD) Models	114
2.3.5.1	Summary of PBPK/PD Models	115
2.3.5.2	Chloroform PBPK Model Comparison	118
2.3.5.3	Discussion of Chloroform Models	118
2.4	MECHANISMS OF ACTION	128
2.4.1	Pharmacokinetic Mechanisms	128
2.4.2	Mechanisms of Toxicity	131
2.4.3	Animal-to-Human Extrapolations	132
2.5	RELEVANCE TO PUBLIC HEALTH	132
2.6	BIOMARKERS OF EXPOSURE AND EFFECT	156
2.6.1	Biomarkers Used to Identify or Quantify Exposure to Chloroform	157
2.6.2	Biomarkers Used to Characterize Effects Caused by Chloroform	159
2.7	INTERACTIONS WITH OTHER CHEMICALS	159
2.8	POPULATIONS THAT ARE UNUSUALLY SUSCEPTIBLE	161
2.9	METHODS FOR REDUCING TOXIC EFFECTS	162
2.9.1	Reducing Peak Absorption Following Exposure	162
2.9.2	Reducing Body Burden	163
2.9.3	Interfering with the Mechanism of Action for Toxic Effects	163
2.10	ADEQUACY OF THE DATABASE	165
2.10.1	Existing Information on Health Effects of Chloroform	165
2.10.2	Identification of Data Needs	166
2.10.3	Ongoing Studies	175
3	CHEMICAL AND PHYSICAL INFORMATION	177
3.1	CHEMICAL IDENTITY	177
3.2	PHYSICAL AND CHEMICAL PROPERTIES	177
4	PRODUCTION, IMPORT/EXPORT, USE, AND DISPOSAL	181

4.1	PRODUCTION	181
4.2	IMPORT/EXPORT	183
4.3	USE	186
4.4	DISPOSAL	187
5.	POTENTIAL FOR HUMAN EXPOSURE	189
5.1	OVERVIEW	189
5.2	RELEASES TO THE ENVIRONMENT	190
5.2.1	Air	190
5.2.2	Water	194
5.2.3	Soil	195
5.3	ENVIRONMENTAL FATE	196
5.3.1	Transport and Partitioning	196
5.3.2	Transformation and Degradation	198
5.3.2.1	Air	198
5.3.2.2	Water	199
5.3.2.3	Sediment and Soil	201
5.4	LEVELS MONITORED OR ESTIMATED IN THE ENVIRONMENT	201
5.4.1	Air	201
5.4.2	Water	203
5.4.3	Sediment and Soil	205
5.4.4	Other Environmental Media	206
5.5	GENERAL POPULATION AND OCCUPATIONAL EXPOSURE	207
5.6	POPULATIONS WITH POTENTIALLY HIGH EXPOSURES	209
5.7	ADEQUACY OF THE DATABASE	210
5.7.1	Identification of Data Needs	210
5.7.2	Ongoing Studies	213
6.	ANALYTICAL METHODS	217
6.1	BIOLOGICAL SAMPLES	217
6.2	ENVIRONMENTAL SAMPLES	220
6.3	ADEQUACY OF THE DATABASE	228
6.3.1	Identification of Data Needs	229
6.3.2	Ongoing Studies	231
7.	REGULATIONS AND ADVISORIES	233
8.	REFERENCES	247
9.	GLOSSARY	291
APPENDICES		
A.	ATSDR MINIMAL RISK LEVEL	A-1
B.	USER'S GUIDE	B-1
C.	ACRONYMS, ABBREVIATIONS, AND SYMBOLS	C-1



## LIST OF FIGURES

2-1	Levels of Significant Exposure to Chloroform—Inhalation .....	25
2-2	Levels of Significant Exposure to Chloroform—Oral .....	66
2-3	Metabolic Pathways of Chloroform Biotransformation .....	109
2-4	Conceptual Representation of a Physiologically Based Pharmacokinetic (PBPK) Model for Hypothetical Chemical Substance .....	116
2-5	Parameters used in the Corley PBPK Model .....	120
2-6	Existing Information on Health Effects of Chloroform .....	167
5-1	Frequency of NPL Sites With Chloroform Contamination .....	191





**LIST OF TABLES**

2-1	Levels of Significant Exposure to Chloroform—Inhalation	13
2-2	Levels of Significant Exposure to Chloroform—Oral	47
2-3	Levels of Significant Exposure to Chloroform—Dermal	99
2-4	Parameters Used in the Corley PBPK Model	121
2-5	Genotoxicity of Chloroform <i>In Vitro</i>	150
2-6	Genotoxicity of Chloroform <i>In Vivo</i>	151
3-1	Chemical Identity of Chloroform	178
3-2	Physical and Chemical Properties of Chloroform	179
4-1	U.S. Production of Chloroform	182
4-2	Facilities That Manufacture or Process Chloroform	184
5-1	Releases to the Environment From Facilities That Manufacture or Process Chloroform	192
6-1	Analytical Methods for Determining Chloroform in Biological Samples	218
6-2	Analytical Methods for Determining Chloroform in Environmental Samples	221
7-1	Regulations and Guidelines Applicable to Chloroform	235



## 1. PUBLIC HEALTH STATEMENT

This public health statement tells you about chloroform and the effects of exposure.

The Environmental Protection Agency (EPA) identifies the most serious hazardous waste sites in the nation. These sites make up the National Priorities List (NPL) and the sites are targeted for long-term federal cleanup. Chloroform has been found in at least 717 of the 1,430 current or former NPL sites, including 6 in Puerto Rico and 1 in the Virgin Islands. However, it's unknown how many NPL sites have been evaluated for this substance. As more sites are evaluated, the sites with chloroform may increase. This is important because exposure to this substance may harm you and because these sites may be sources of exposure.

When a substance is released from a large area, such as an industrial plant, or from a container, such as a drum or bottle, it enters the environment. This release does not always lead to exposure. You are exposed to a substance only when you come in contact with it. You may be exposed by breathing, eating, or drinking the substance, or by skin contact.

If you are exposed to chloroform, many factors determine whether you'll be harmed. These factors include the dose (how much), the duration (how long), and how you come in contact with it. You must also consider the other chemicals you're exposed to and your age, sex, diet, family traits, lifestyle, and state of health.

### 1.1 WHAT IS CHLOROFORM?

Chloroform is also known as trichloromethane or methyltrichloride. It is a colorless liquid with a pleasant, nonirritating odor and a slightly sweet taste. Most of the chloroform found in the environment comes from industry. It will only burn when it reaches very high temperatures. Chloroform was one of the first inhaled anesthetics to be used during surgery, but it is not used for anesthesia today. Nearly all the chloroform made in the United States

## 1. PUBLIC HEALTH STATEMENT

today is used to make other chemicals, but some is sold or traded to other countries. We also import chloroform.

Chloroform enters the environment from chemical companies and paper mills, It is also found in waste water from sewage treatment plants and drinking water to which chlorine has been added. Chlorine is added to most drinking water and many waste waters to destroy bacteria. Small amounts of chloroform are formed as an unwanted product during the process of adding chlorine to water. Chloroform can enter the air directly from factories that make or use it and by evaporating from water and soil that contain it. It can enter water and soil when waste water that contains chlorine is released into water or soil. It may enter water and soil from spills and by leaks from storage and waste sites. There are many ways for chloroform to enter the environment, so small amounts of it are likely to be found almost everywhere. You will find more information about what chloroform is, how it is used, and where it comes from in Chapters 3 and 4.

### **1.2 WHAT HAPPENS TO CHLOROFORM WHEN IT ENTERS THE ENVIRONMENT?**

Chloroform evaporates very quickly when exposed to air. Chloroform also dissolves easily in water, but does not stick to the soil very well. This means that it can travel down through soil to groundwater where it can enter a water supply. Chloroform lasts for a long time in both the air and in groundwater. Most chloroform in the air eventually breaks down, but this process is slow. The breakdown products in air include phosgene, which is more toxic than chloroform, and hydrogen chloride, which is also toxic. Some chloroform may break down in soil. Chloroform does not appear to build up in great amounts in plants and animals, but we may find some small amounts of chloroform in foods. You will find more information about where chloroform comes from, how it behaves, and how long it remains in the environment in Chapter 5.

## 1. PUBLIC HEALTH STATEMENT

### 1.3 HOW MIGHT I BE EXPOSED TO CHLOROFORM?

You are probably exposed to small amounts of chloroform in your drinking water and in beverages (such as soft drinks) made using water that contains chloroform. You can also get chloroform in your body by eating food, by breathing air, and by skin contact with water that contains it. You are most likely to be exposed to chloroform by drinking water and breathing indoor or outdoor air containing it. The amount of chloroform normally expected to be in the air ranges from 0.02 to 0.05 parts of chloroform per billion parts (ppb) of air and from 2 to 44 ppb in treated drinking water. However, in some places, chloroform concentrations may be higher than 44 ppb. It is estimated that the concentration of chloroform in surface water is 0.1 ppb, the concentration in untreated groundwater is 0.1 ppb, and the amount in soil is 0.1 ppb. As much as 610 ppb was found in air at a municipal landfill and up to 88 ppb was found in treated municipal drinking water. Drinking water derived from well water near a hazardous waste site contained 1,900 ppb, and groundwater taken near a hazardous waste site also contained 1,900 ppb. Surface water containing 394 ppb has also been found near a hazardous waste site; however, no more than 0.13 ppb has been found in soil at hazardous waste sites. Chloroform has been found in the air from all areas of the United States and in nearly all of the public drinking water supplies. We do not know how many areas have surface water, groundwater, or soil that contains chloroform.

The average amount of chloroform that you might be exposed to on a typical day by breathing air in various places ranges from 2 to 5 micrograms per day ( $\mu\text{g}/\text{day}$ ) in rural areas, 6 to 200  $\mu\text{g}/\text{day}$  in cities, and 80 to 2,200  $\mu\text{g}/\text{day}$  in areas near major sources of the chemical. The estimated amount of chloroform you probably are exposed to in drinking water ranges from 4 to 88  $\mu\text{g}/\text{day}$ . We cannot estimate the amounts that you may be exposed to by eating food and by coming into contact with water that has chloroform in it. People who swim in swimming pools absorbed chloroform through their skin. People who work at or near chemical plants and factories that make or use chloroform can be exposed to higher-than-normal amounts of chloroform. Higher exposures might occur in workers at drinking-water treatment plants, waste water treatment plants, and paper and pulp mills. People who operate waste-burning equipment may also be exposed to higher than normal levels. The National

## I. PUBLIC HEALTH STATEMENT

Institute for Occupational Safety and Health (NIOSH) estimated that 95,778 persons in the United States have occupational exposure to chloroform. You will find more information about how you can be exposed to chloroform in Chapter 5.

### **1.4 HOW CAN CHLOROFORM ENTER AND LEAVE MY BODY?**

Chloroform can enter your body if you breathe air, eat food, or drink water that contains chloroform. Chloroform easily enters your body through the skin. Therefore, chloroform may also enter your body if you take a bath or shower in water containing chloroform. In addition, you can breathe in chloroform if the shower water is hot enough for chloroform to evaporate. Studies in people and in animals show that after you breathe air or eat food that has chloroform in it, the chloroform can quickly enter your bloodstream from your lungs or intestines. Inside your body, chloroform is carried by the blood to all parts of your body, such as the fat, liver, and kidneys. Chloroform usually collects in body fat; however, its volatility ensures that it will eventually be removed once the exposure has been removed. Some of the chloroform that enters your body leaves unchanged in the air that you breathe out, and some chloroform in your body is broken down into other chemicals. These chemicals are known as breakdown products or metabolites, and some of them can attach to other chemicals inside the cells of your body and may cause harmful effects if they collect in high enough amounts in your body. Some of the metabolites also leave the body in the air you breathe out. Only a small amount of the breakdown products leaves the body in the urine and stool.

You can find more information about the behavior of chloroform in the body in Chapter 2.

### **1.5 HOW CAN CHLOROFORM AFFECT MY HEALTH?**

To protect the public from the harmful effects of toxic chemicals and to find ways to treat people who have been harmed, scientists use many tests.

## 1. PUBLIC HEALTH STATEMENT

One way to see if a chemical will hurt people is to learn how the chemical is absorbed, used, and released by the body; for some chemicals, animal testing may be necessary. Animal testing may also be used to identify health effects such as cancer or birth defects. Without laboratory animals, scientists would lose a basic method to get information needed to make wise decisions to protect public health. Scientists have the responsibility to treat research animals with care and compassion. Laws today protect the welfare of research animals, and scientists must comply with strict animal care guidelines.

In humans, chloroform affects the central nervous system (brain), liver, and kidneys after a person breathes air or drinks liquids that contain large amounts of chloroform. Chloroform was used as an anesthetic during surgery for many years before its harmful effects on the liver and kidneys were recognized. Breathing about 900 parts of chloroform in a million parts of air (900 ppm or 900,000 ppb) for a short time causes fatigue, dizziness, and headache. If you breathe air, eat food, or drink water containing elevated levels of chloroform, over a long period, the chloroform may damage your liver and kidneys. Large amounts of chloroform can cause sores when the chloroform touches your skin.

We do not know whether chloroform causes harmful reproductive effects or birth defects in people. Miscarriages occurred in rats and mice that breathed air containing elevated levels (30 to 300 ppm) of chloroform during pregnancy and in rats that ate chloroform during pregnancy. Abnormal sperm were found in mice that breathed air containing elevated levels (400 ppm) of chloroform for a few days. Offspring of rats and mice that breathed chloroform during pregnancy had birth defects.

Results of studies of people who drank chlorinated water showed a possible link between the chloroform in chlorinated water and the occurrence of cancer of the colon and urinary bladder. Cancer of the liver and kidneys developed in rats and mice that ate food or drank water that had large amounts of chloroform in it for a long time. We do not know whether liver and kidney cancer would develop in people after long-term exposure to chloroform in drinking water. Based on animal studies, the Department of Health and Human Services (DHHS) has determined that chloroform may reasonably be anticipated to be a carcinogen (a



## 1. PUBLIC HEALTH STATEMENT

substance that causes cancer). The International Agency for Research on Cancer (IARC) has determined that chloroform is possibly carcinogenic to humans (2B). The EPA has determined that chloroform is a probable human carcinogen.

You can find a more complete discussion about how chloroform affects your health in Chapter 2.

### **1.6 IS THERE A MEDICAL TEST TO DETERMINE WHETHER I HAVE BEEN EXPOSED TO CHLOROFORM?**

Although we can measure the amount of chloroform in the air that you breathe out, and in blood, urine, and body tissues, we have no reliable test to determine how much chloroform you have been exposed to or whether you will experience any harmful health effects. The measurement of chloroform in body fluids and tissues may help to determine if you have come into contact with large amounts of chloroform. However, these tests are useful only a short time after you are exposed to chloroform because it leaves the body quickly. Because it is a breakdown product of other chemicals (chlorinated hydrocarbons), chloroform in your body might also indicate that you have come into contact with those other chemicals. Therefore, small amounts of chloroform in the body may indicate exposure to these other chemicals and may not indicate low chloroform levels in the environment. From blood tests to determine the amount of liver enzymes, we can tell whether the liver has been damaged, but we cannot tell whether the liver damage was caused by chloroform.

### **1.7 WHAT RECOMMENDATIONS HAS THE FEDERAL GOVERNMENT MADE TO PROTECT HUMAN HEALTH?**

The federal government develops regulations and recommendations to protect public health. Regulations can be enforced by law. Federal agencies that develop regulations for toxic substances include EPA, the Occupational Safety and Health Administration (OSHA), and the Food and Drug Administration (FDA). Recommendations provide valuable guidelines to protect public health but cannot be enforced by law. Federal organizations that develop

## 1. PUBLIC HEALTH STATEMENT

recommendations for toxic substances include the Agency for Toxic Substances and Disease Registry (ATSDR) and the National Institute for Occupational Safety and Health (NIOSH).

Regulations and recommendations can be expressed in not-to-exceed levels in air, water, soil, or food that are usually based on levels that affect animals; then they are adjusted to help protect people. Sometimes these not-to-exceed levels differ among federal organizations because of different exposure times (an 8-hour workday or a 24-hour day), the use of different animal studies, or other factors.

Recommendations and regulations are also periodically updated as more information becomes available. For the most current information, check with the federal agency or organization that provides it. Some regulations and recommendations for chloroform include the following:

The EPA sets rules for the amount of chloroform allowed in water. The EPA limit for total trihalomethanes, a class of chemicals that includes chloroform, in drinking water is 100 micrograms per liter ( $\mu\text{g/L}$ ,  $1 \mu\text{g/L} = 1 \text{ ppb}$  in water). Furthermore, EPA requires that spills of 10 pounds or more of chloroform into the environment be reported to the National Response Center.

OSHA sets the levels of chloroform allowed in workplace air in the United States. A permissible occupational exposure limit is 50 ppm or  $240 \text{ mg/m}^3$  (ceiling value) in air during an 8-hour workday, 40-hour workweek.

## 1. PUBLIC HEALTH STATEMENT

### 1.8 WHERE CAN I GET MORE INFORMATION?

If you have any more questions or concerns, please contact your community or state health or environmental quality department or:

Agency for Toxic Substances and Disease Registry  
Division of Toxicology  
1600 Clifton Road NE, Mailstop E-29  
Atlanta, GA 30333

\* Information line and technical assistance

Phone: (404) 639-6000

Fax: (404) 639-6315 or 6324

ATSDR can also tell you the location of occupational and environmental health clinics. These clinics specialize in recognizing, evaluating, and treating illnesses resulting from exposure to hazardous substances.

\* To order toxicological profiles, contact:

National Technical Information Service  
5285 Port Royal Road  
Springfield, VA 22161  
Phone: (800) 553-6847 or (703) 487-4650

## 2. HEALTH EFFECTS

### 2.1 INTRODUCTION

The primary purpose of this chapter is to provide public health officials, physicians, toxicologists, and other interested individuals and groups with an overall perspective of the toxicology of chloroform. It contains descriptions and evaluations of toxicological studies and epidemiological investigations and provides conclusions, where possible, on the relevance of toxicity and toxicokinetic data to public health.

A glossary and list of acronyms, abbreviations, and symbols can be found at the end of this profile.

### 2.2 DISCUSSION OF HEALTH EFFECTS BY ROUTE OF EXPOSURE

To help public health professionals and others address the needs of persons living or working near hazardous waste sites, the information in this section is organized first by route of exposure--inhalation, oral, and dermal; and then by health effect--death, systemic, immunological, neurological, reproductive, developmental, genotoxic, and carcinogenic effects. These data are discussed in terms of three exposure periods--acute (14 days or less), intermediate (15-364 days), and chronic (365 days or more).

Levels of significant exposure for each route and duration are presented in tables and illustrated in figures. The points in the figures showing no-observed-adverse-effect levels (NOAELs) or lowest-observed-adverse-effect levels (LOAELs) reflect the actual doses (levels of exposure) used in the studies. LOAELs have been classified into "less serious" or "serious" effects. "Serious" effects are those that evoke failure in a biological system and can lead to morbidity or mortality (e.g., acute respiratory distress or death). "Less serious" effects are those that are not expected to cause significant dysfunction or death, or those whose significance to the organism is not entirely clear. ATSDR acknowledges that a considerable amount of judgment may be required in establishing whether an end point should be classified as a NOAEL, "less serious" LOAEL, or "serious" LOAEL, and that in some cases, there will be insufficient data to decide whether the effect is indicative of significant dysfunction. However, the Agency has established guidelines and policies that are used to classify these end points. ATSDR believes that there is sufficient merit in this approach to warrant an attempt

## 2. HEALTH EFFECTS

at distinguishing between “less serious” and “serious” effects. The distinction between “less serious” effects and “serious” effects is considered to be important because it helps the users of the profiles to identify levels of exposure at which major health effects start to appear. LOAELs or NOAELs should also help in determining whether or not the effects vary with dose and/or duration, and place into perspective the possible significance of these effects to human health.

The significance of the exposure levels shown in the Levels of Significant Exposure (LSE) tables and figures may differ depending on the user’s perspective. Public health officials and others concerned with appropriate actions to take at hazardous waste sites may want information on levels of exposure associated with more subtle effects in humans or animals (LOAEL) or exposure levels below which no adverse effects (NOAELs) have been observed. Estimates of levels posing minimal risk to humans (Minimal Risk Levels or MRLs) may be of interest to health professionals and citizens alike.

Levels of exposure associated with the carcinogenic effects (Cancer Effect Levels, CELs) of chloroform are indicated in Figure 2-2. Because cancer effects could occur at lower exposure levels, Figures 2-1 and 2-2 also show a range for the upper bound of estimated excess risks, ranging from a risk of 1 in 10,000 to 1 in 10,000,000 ( $10^{-4}$  to  $10^{-7}$ ), as developed by EPA.

Estimates of exposure levels posing minimal risk to humans (Minimal Risk Levels or MRLs) have been made for chloroform. An MRL is defined as an estimate of daily human exposure to a substance that is likely to be without an appreciable risk of adverse effects (noncarcinogenic) over a specified duration of exposure. MRLs are derived when reliable and sufficient data exist to identify the target organ(s) of effect or the most sensitive health effect(s) for a specific duration within a given route of exposure. MRLs are based on noncancerous health effects only and do not consider carcinogenic effects. MRLs can be derived for acute-, intermediate-, and chronic-duration exposures for inhalation and oral routes. Appropriate methodology does not exist to develop MRLs for dermal exposure.

Although methods have been established to derive these levels (Barnes and Dourson 1988; EPA 1990b), uncertainties are associated with these techniques. Furthermore, ATSDR acknowledges additional uncertainties inherent in the application of the procedures to derive less than lifetime MRLs. As an example, acute inhalation MRLs may not be protective for health effects that are delayed in development or are acquired following repeated acute insults, such as hypersensitivity reactions,

## 2. HEALTH EFFECTS

asthma, or chronic bronchitis. As these kinds of health effects data become available and methods to assess levels of significant human exposure improve, these MRLs will be revised.

A User's Guide has been provided at the end of this profile (see Appendix B). This guide should aid in the interpretation of the tables and figures for Levels of Significant Exposure and the MRLs.

### 2.2.1 Inhalation Exposure

Most of the data regarding inhalation exposure to chloroform in humans were obtained from clinical reports describing health effects in patients under anesthesia. In some instances, the results may have been confounded by the concurrent administration of other drugs with chloroform or by artificial respiration of patients under chloroform anesthesia. Furthermore, most of the studies did not provide any information regarding actual exposure levels for observed effects. Nonetheless, chloroform-induced effects in humans are supported by those observed in animals under experimental conditions.

The human studies cited in the profile provide qualitative information on chloroform toxicity in humans.

#### 2.2.1.1 Death

Information on the exposure levels of chloroform leading to death in humans was obtained from clinical reports of patients exposed to chloroform as a method of anesthesia. It should be noted that when examining the ability of chloroform to cause death, these clinical reports may be misleading, in that many of these patients had pre-existing health conditions that may have contributed to the cause of death and that chloroform toxicity may not have been the only factor involved in the death of the patient. Older clinical case reports suggested that concentrations of  $\approx 40,000$  ppm, if continued for several minutes, may be an overdose (Featherstone 1947). When a cohort of 1,502 patients, ranging in age from 1 to 80 years, exposed under anesthesia to less than 22,500 ppm chloroform was evaluated, no indication of increased mortality was found (Whitaker and Jones 1965). In most patients, the anesthesia did not last longer than 30 minutes; however, a few received chloroform for more than 2 hours. Several studies reported deaths in women after childbirth when chloroform anesthesia had been used (Royston 1924; Townsend 1939). No levels of actual exposure were provided in either study. Death was caused by acute hepatotoxicity. Prolonged labor with starvation, dehydration, and exhaustion contributed to the chloroform-induced hepatotoxicity.

## 2. HEALTH EFFECTS

Levels of acute exposure resulting in animal deaths are generally lower than those reported for human patients under anesthesia; however, the exposure durations are generally longer in the animal studies. An inhalation LC<sub>50</sub> (lethal concentration, 50% kill) of 9,770 ppm for a 4-hour exposure was reported for female rats (Lundberg et al. 1986). One rat died after 6 exposures in one report where groups of 9-12 pregnant female rats exposed to chloroform at doses as high as 4,117 ppm for 1 hour a day for 8 days (Newell and Dilley 1978). However, exposure to 8,000 ppm for 4 hours was lethal to albino rats (Smyth et al. 1962). Male mice appear to be more sensitive than female mice. Following exposure to 1,024 ppm for 1-3 hours, 15 of 18 male mice died within 11 days; however, most of the female mice similarly exposed survived for several months (Deringer et al. 1953). Male mice that died had kidney and liver damage, while females did not. An exposure as low as 692 ppm for 1-3 hours resulted in the death of 3 of 6 male mice within 8 days. When exposed to 4,500 ppm chloroform for 9 hours, 10 of 20 female mice died (Gehring 1968). Increased mortality was observed in male rats exposed to 85 ppm chloroform for 6 months (Torkelson et al. 1976). The deaths were attributed to interstitial pneumonia. Rats of either sex exposed to 50 ppm survived. Exposure to 85 ppm for 6 months did not increase mortality in rabbits and guinea pigs. Similarly, no deaths were reported in dogs exposed to 25 ppm chloroform for the same time period.

The LC<sub>50</sub> and all reliable LOAEL values for death in each species and duration category are recorded in Table 2-1 and plotted in Figure 2-I.

### 2.2.1.2 Systemic Effects

No studies were located regarding dermal or ocular effects in humans or animals after inhalation exposure to chloroform.

The highest NOAEL values and all reliable LOAEL values for each systemic effect in each species and duration category are recorded in Table 2- 1 and plotted in Figure 2-I.

**Respiratory Effects.** Changes in respiratory rate were observed in patients exposed to chloroform via anesthesia (exposure less than 22,500 ppm) (Whitaker and Jones 1965). Increased respiratory rates were observed in 44% of 1,502 patients who were exposed to light chloroform anesthesia. Respiratory rates were depressed, however, during deep and prolonged anesthesia when chloroform concentrations

Table 2-1. Levels of Significant Exposure to Chloroform - Inhalation

Key to figure <sup>a</sup>	Species/ (strain)	Exposure/ duration/ frequency	System	NOAEL (ppm)	LOAEL		Reference
					Less serious (ppm)	Serious (ppm)	
<b>ACUTE EXPOSURE</b>							
<b>Death</b>							
1	Rat (Albino)	4 hr				8000 (5/6 died)	Smyth et al. 1962
2	Rat (Sprague-Dawley)	4 hr				9770 F (LC <sub>50</sub> )	Lundberg et al. 1986
3	Rat (Sprague-Dawley)	8 d Gd 7-14 1 hr/d				4117 F (death; 1 animal on Gd 12)	Newell and Dilley 1978
4	Mouse (Swiss-Webster)	9 hr				4500 F (10/20 died)	Gehring 1968
5	Mouse (C3H)	1-3 hr				692 M (3/6 died)	Deringer et al. 1953
<b>Systemic</b>							
6	Human	113 min	Cardio Gastro Hemato Hepatic		8000 (vomiting) 8000 (increased prothrombin time)	8000 (arrhythmia) 8000 (increased sulfobromophthalein sodium retention)	Smith et al. 1973



Table 2-1. Levels of Significant Exposure to Chloroform - Inhalation (continued)

Key to figure <sup>a</sup>	Species/ (strain)	Exposure/ duration/ frequency	System	NOAEL (ppm)	LOAEL		Reference		
					Less serious (ppm)	Serious (ppm)			
7	Human	0.5-2 hr	Resp		22,500	(changes in respiratory rate)		Whitaker and Jones 1965	
			Cardio				22,500		(cardiac arrhythmia, bradycardia)
			Gastro		22,500	(vomiting)			
			Hepatic		22,500	(transient jaundice in 1 patient)			
8	Rat (Sprague-Dawley)	8 d Gd 7-14 1 hr/d	Bd Wt	2232 F			4117 F (60% decreased maternal body weight gain)	Newell and Dilley 1978	
9	Rat (Sprague-Dawley)	4 hr	Hepatic	76 F	153 F	(SDH-enzyme levels increased)		Lundberg et al. 1986	
10	Rat (Wistar)	10 d Gd 7-16 7 hr/d	Hepatic	300 F				Baeder and Hofmann 1988	
			Renal Bd Wt	300 F	30 F	(18% decreased weight gain of dams)	100 F		(24% decreased weight gain of dams)
			Other		30 F	(decrease in feed consumption)			
11	Rat (Wistar)	8 hr	Hepatic		50 M	(elevated liver triglycerides and liver GSH)		Ikatsu and Nakajima 1992	
12	Rat (Fischer- 344)	7 d 6 hr/d	Resp	3.1 M	10.4 M	(degeneration of Bowman's gland; new bone formation; increased number of S-phase nuclei)		Mery et al. 1994	
			Bd Wt	100 M	271 M	(unspecified decrease in body weight)			

Table 2-1. Levels of Significant Exposure to Chloroform - Inhalation (continued)

Key to figure <sup>a</sup>	Species/ (strain)	Exposure/ duration/ frequency	System	NOAEL (ppm)	LOAEL		Reference
					Less serious (ppm)	Serious (ppm)	
13	Rat (Fischer- 344)	7 d 6 hr/d	Resp	3.1 M	10.4 M	(epithelial goblet cell hyperplasia and degeneration of Bowman's glands in olfactory mucosa)	Larson et al. 1994c
			Hepatic	100 M	271 M	(swelling and mild centrilobular vacuolation)	
			Renal	10.4 M	29.3 M	(increased number of S-phase nuclei for tubule cells in the cortex)	
			Bd Wt	3.1 M	10.4 M	(decreased weight gain)	
14	Rat (Wistar)	6 hr	Hepatic	100 M	500 M	(increased plasma GOT and GPT; decreased hepatic GSH)	Wang et al. 1994
15	Rat (Wistar)	6 hr	Hepatic	100	500	(incr. plasma GOT activity)	Wang et al. 1995
16	Mouse (CBA; W.H.)	2 hr	Hepatic		246	(fatty changes)	Culliford and Hewitt 1957
			Renal	246 F		246 M (tubular necrosis in males)	
17	Mouse (NS)	4 hr	Hepatic		100 F	(fatty changes)	Kylin et al. 1963
18	Mouse (C3H)	1-3 hr	Resp	1106			Deringer et al. 1953
			Hepatic	1106 F		942 M (liver necrosis in males that died)	
			Renal	1106 F		692 M (tubular necrosis in males that died)	

Table 2-1. Levels of Significant Exposure to Chloroform - Inhalation (continued)

Key to figure <sup>a</sup>	Species/ (strain)	Exposure/ duration/ frequency	System	NOAEL (ppm)	LOAEL		Reference
					Less serious (ppm)	Serious (ppm)	
19	Mouse (CF1)	8 d Gd 1-7, Gd 6-15, or Gd 8-15 7 hr/d	Hepatic  Bd Wt		100 F (increased SGPT activity; increased absolute and relative liver weights)		Murray et al. 1979
20	Mouse (Swiss-Webster)	9 hr	Hepatic		4500 F (increased SGPT activity)		Gehring 1968
21	Mouse (B6C3F1)	7 d 6 hr/d	Resp  Bd Wt	3 F  29.5 F	10 F (increased number of S-phase nuclei)  101 F (unspecified decr. in body weight)		Mery et al. 1994
22	Mouse (B6C3F1)	7 d 6 hr/d	Resp  Hepatic  Renal  Bd Wt	288 F  3 <sup>b</sup> F  101 F  288 F	10 F (mild to moderate vacuolar changes in centrilobular hepatocytes)  288 F (proximal tubules lined by regenerating epithelium)	101 F (centrilobular hepatocyte necrosis and severe diffuse vacuolar degeneration of midzonal and periportal hepatocytes)	Larson et al. 1994c

Table 2-1. Levels of Significant Exposure to Chloroform - Inhalation (continued)

Key to figure <sup>a</sup>	Species/ (strain)	Exposure/ duration/ frequency	System	NOAEL (ppm)	LOAEL		Reference
					Less serious (ppm)	Serious (ppm)	
23	Mouse (B6C3F1)	4 d 6 hr/d	Resp	2 F	10 F	(mild, transient, proliferative responses & bone thickening in the periosteum and posterior ventral areas)	Larson et al. 1996
			Musc/skel	88 F	88 F (increased relative liver weights; hepatocyte lipid vacuolization & scattered individual hepatocyte necrosis; significant increase in hepatic LI)		
			Hepatic	30 F			
			Renal	88 F			
<b>Immunological/Lymphoreticular</b>							
24	Rat (Wistar)	10 d Gd 7-16 7 hr/d		300 F			Baeder and Hofmann 1988
25	Mouse (C3H)	1-3 hr		1106			Deringer et al. 1953
<b>Neurological</b>							
26	Human	3 min			920	(dizziness, vertigo)	Lehman and Hasegawa 1910
27	Human	113 min				8000 (narcosis)	Smith et al. 1973
28	Human	0.5-2 hr				22,500 (narcosis)	Whitaker and Jones 1965
29	Mouse (NS)	0.5-2 hr		2500		3100 (slight narcosis)	Lehmann and Flury 1943
30	Cat (NS)	5-93 min				7,200 (disturbed equilibrium)	Lehmann and Flury 1943

Table 2-1. Levels of Significant Exposure to Chloroform - Inhalation (continued)

Key to figure <sup>a</sup>	Species/ (strain)	Exposure/ duration/ frequency	System	NOAEL (ppm)	LOAEL		Reference
					Less serious (ppm)	Serious (ppm)	
<b>Reproductive</b>							
31	Rat (Sprague-Dawley)	10 d Gd 6-15 7 hr/d		100 F		300 F (73% decreased conception rate; increased incidence of fetal resorptions)	Schwetz et al. 1974
32	Rat (Wistar)	10 d Gd 7-16 7 hr/d				30 F (empty implantations in 2/20 dams)	Baeder and Hofmann 1988
33	Mouse (CF1)	8 d Gd 1-7, Gd 6-15, or Gd 8-15 7 hr/d				100 F (increased incidence of resorptions; decrease in % pregnancies)	Murray et al. 1979
34	Mouse (C57B1/C3H)F1	5 d 4 hr/d				400 M (increased percentage of abnormal sperm)	Land et al. 1979
<b>Developmental</b>							
35	Rat (Sprague-Dawley)	10 d Gd 6-15 7 hr/d			30 (delayed ossification and wavy ribs)	100 (missing ribs; acaudate fetuses with imperforate anus)	Schwetz et al. 1974
36	Rat (Wistar)	10 d Gd 7-16 7 hr/d			30 (slight growth retardation)		Baeder and Hofmann 1988
37	Mouse (CF1)	8 d Gd 1-7, Gd 6-15, or Gd 8-15 7 hr/d				100 (cleft palate, decreased ossification)	Murray et al. 1979

Table 2-1. Levels of Significant Exposure to Chloroform - Inhalation (continued)

Key to figure <sup>a</sup>	Species/ (strain)	Exposure/ duration/ frequency	System	NOAEL (ppm)	LOAEL		Reference
					Less serious (ppm)	Serious (ppm)	
<b>INTERMEDIATE EXPOSURE</b>							
<b>Death</b>							
38	Rat (NS)	6 mo 5 d/wk 7 hr/d				85 M (increased mortality; 4/10 died)	Torkelson et al. 1976
<b>Systemic</b>							
39	Human	1-6 mo	Gastro Hepatic		14 (nausea; vomiting) 14 <sup>c</sup> (toxic hepatitis)		Phoon et al. 1983
40	Rat (NS)	6 mo 5 d/wk 7 hr/d	Resp	50 M 85 F	85 M (interstitial pneumonia)		Torkelson et al. 1976
			Hemato Hepatic Renal Bd Wt	85  25 M 85 F	25 (degenerative changes) 25 (cloudy swelling) 50 M (decreased body weight in males)		
41	Mouse (B6C3F1)	3 wk 7 d/wk 6 hr/d	Resp  Musc/skel Hepatic  Renal  Bd Wt	88  88 10  10 M 88 F  88	29.6 (hepatocyte vacuolation and swelling; variations in nuclear size) 29.6 M (nephropathy of epithelial cells of the proximal convoluted tubules)		Larson et al. 1996

Table 2-1. Levels of Significant Exposure to Chloroform - Inhalation (continued)

Key to figure <sup>a</sup>	Species/ (strain)	Exposure/ duration/ frequency	System	NOAEL (ppm)	LOAEL		Reference
					Less serious (ppm)	Serious (ppm)	
42	Mouse (B6C3F1)	6 wk 7 d/wk 6 hr/d	Resp	88			Larson et al. 1996
			Musc/skel	88			
			Hepatic	10 F	29.6 F	(16.1% increase in relative liver weights; mild degenerative changes in hepatocytes; increase in liver LI)	
			Renal	88			
			Bd Wt	88 F			
43	Mouse (B6C3F1)	13 wk 7 d/wk 6 hr/d	Resp	88			Larson et al. 1996
			Musc/skel	88			
			Hepatic	10	29.6	(vacuolation and swelling of hepatocytes; variations in nuclear size)	
			Renal	1.99 M	10 M	(nephropathy & enlarged nuclei of the epithelial cells of the proximal convoluted tubules; mineralization in the cortex)	
						Bd Wt	
			Bd Wt	88			

Table 2-1. Levels of Significant Exposure to Chloroform - Inhalation (continued)

Key to figure <sup>a</sup>	Species/ (strain)	Exposure/ duration/ frequency	System	NOAEL (ppm)	LOAEL		Reference
					Less serious (ppm)	Serious (ppm)	
44	Mouse (B6C3F1)	13 wk 5 d/wk 6 hr/d	Resp	88			Larson et al. 1996
			Musc/skel	88			
			Hepatic	29.6	88	(increased relative liver weights; vacuolation & swelling of hepatocytes & enlarged nuclei; increased liver LI)	
			Renal	1.99 M	10 M	(nephropathies and enlarged nuclei in epithelial cells of the proximal convoluted tubules; mineralization within the cortex; increased cortical and medullary tissue LIs)	
			Bd Wt	88 F 29.6			
45	Dog (NS)	6 mo 5 d/wk 7 hr/d	Hemato	25			Torkelson et al. 1976
			Hepatic	25			
			Renal	25 M	25 F	(cloudy swelling of tubular epithelium)	
46	Rabbit (NS)	6 mo 5 d/wk 7 hr/d	Resp	50 M	25 F 85 M	(interstitial pneumonia) (pneumonitis)	Torkelson et al. 1976
			Hemato	85			
			Hepatic		25	(centrilobular granular degeneration and necrosis)	
			Renal		25	(interstitial nephritis)	



Table 2-1. Levels of Significant Exposure to Chloroform - Inhalation (continued)

Key to figure	Species/ (strain)	Exposure/ duration/ frequency	System	NOAEL (ppm)	LOAEL		Reference
					Less serious (ppm)	Serious (ppm)	
47	Gn pig (NS)	6 mo 5 d/wk 7 hr/d	Hemato	85			Torkelson et al. 1976
			Hepatic		25	(centrilobular granular degeneration)	
			Renal		25	(tubular and interstitial nephritis)	
<b>Immunological/Lymphoreticular</b>							
48	Rat (NS)	6 mo 5 d/wk 7 hr/d		25			Torkelson et al. 1976
<b>Reproductive</b>							
49	Rat (NS)	6 mo 5 d/wk 7 hr/d		25 M			Torkelson et al. 1976

Table 2-1. Levels of Significant Exposure to Chloroform - Inhalation (continued)

Key to figure <sup>a</sup>	Species/ (strain)	Exposure/ duration/ frequency	System	NOAEL (ppm)	LOAEL		Reference
					Less serious (ppm)	Serious (ppm)	
<b>CHRONIC EXPOSURE</b>							
<b>Systemic</b>							
50	Human	10-24 mo	Gastro Hepatic	71	22 F	(nausea)	Challen et al. 1958
51	Human	1-4 yr	Hepatic		2 <sup>d</sup>	(hepatomegaly)	Bomski et al. 1967
52	Human	3-10 yr	Gastro Hepatic	237 F	77 F	(nausea)	Challen et al. 1958
53	Human	1-15 yr	Hepatic  Renal	13.5	29.5	(elevated serum prealbumin and transferrin)	Li et al. 1993
<b>Immunological/Lymphoreticular</b>							
54	Human	1-4 yr			2	(splenomegaly)	Bomski et al. 1967
<b>Neurological</b>							
55	Human	3-10 yr			77 F	(exhaustion, irritability, depression, lack of concentration)	Challen et al. 1958
56	Human	10-24 mo			22 F	(exhaustion)	Challen et al. 1958

Table 2-1. Levels of Significant Exposure to Chloroform - Inhalation (continued)

Key to figure <sup>a</sup>	Species/ (strain)	Exposure/ duration/ frequency	System	NOAEL (ppm)	LOAEL		Reference
					Less serious (ppm)	Serious (ppm)	
57	Human	1-15 yr			13.49	(dizziness, fatigue, somnolence, insomnia, increased dreaming, hypomnesia, anorexia, and palpitations)	Li et al. 1993

<sup>a</sup>The number corresponds to entries in Figure 2-1.

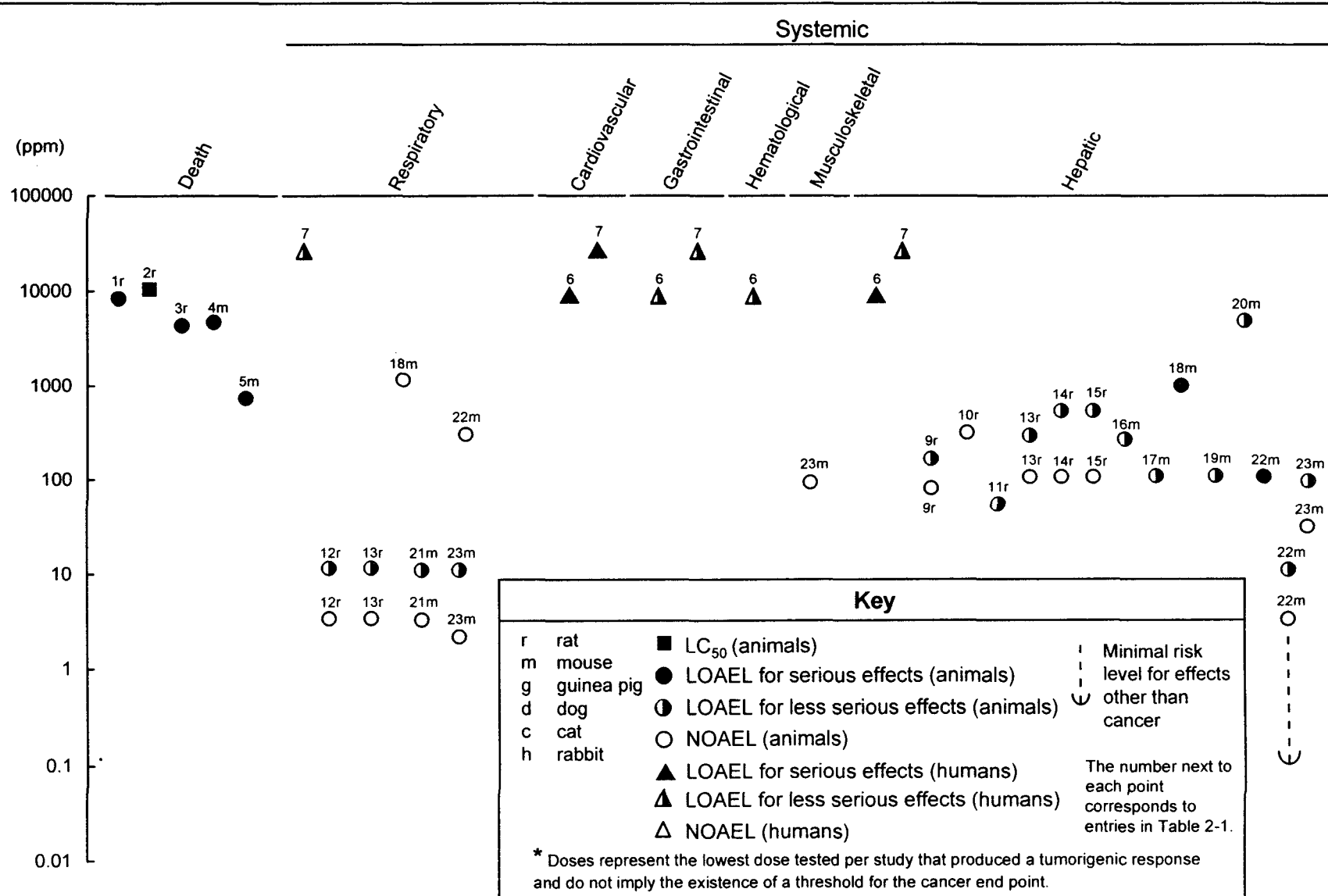
<sup>b</sup>Used to derive an acute-duration inhalation minimal risk level (MRL) of 0.1 ppm; concentration is converted to a human equivalent concentration and divided by an uncertainty factor of 30 (3 for extrapolation from animals to humans and 10 for human variability).

<sup>c</sup>Used to derive an intermediate-duration inhalation MRL of 0.05 ppm; concentration is divided by an uncertainty factor of 100 (10 for use of a LOAEL and 10 for human variability).

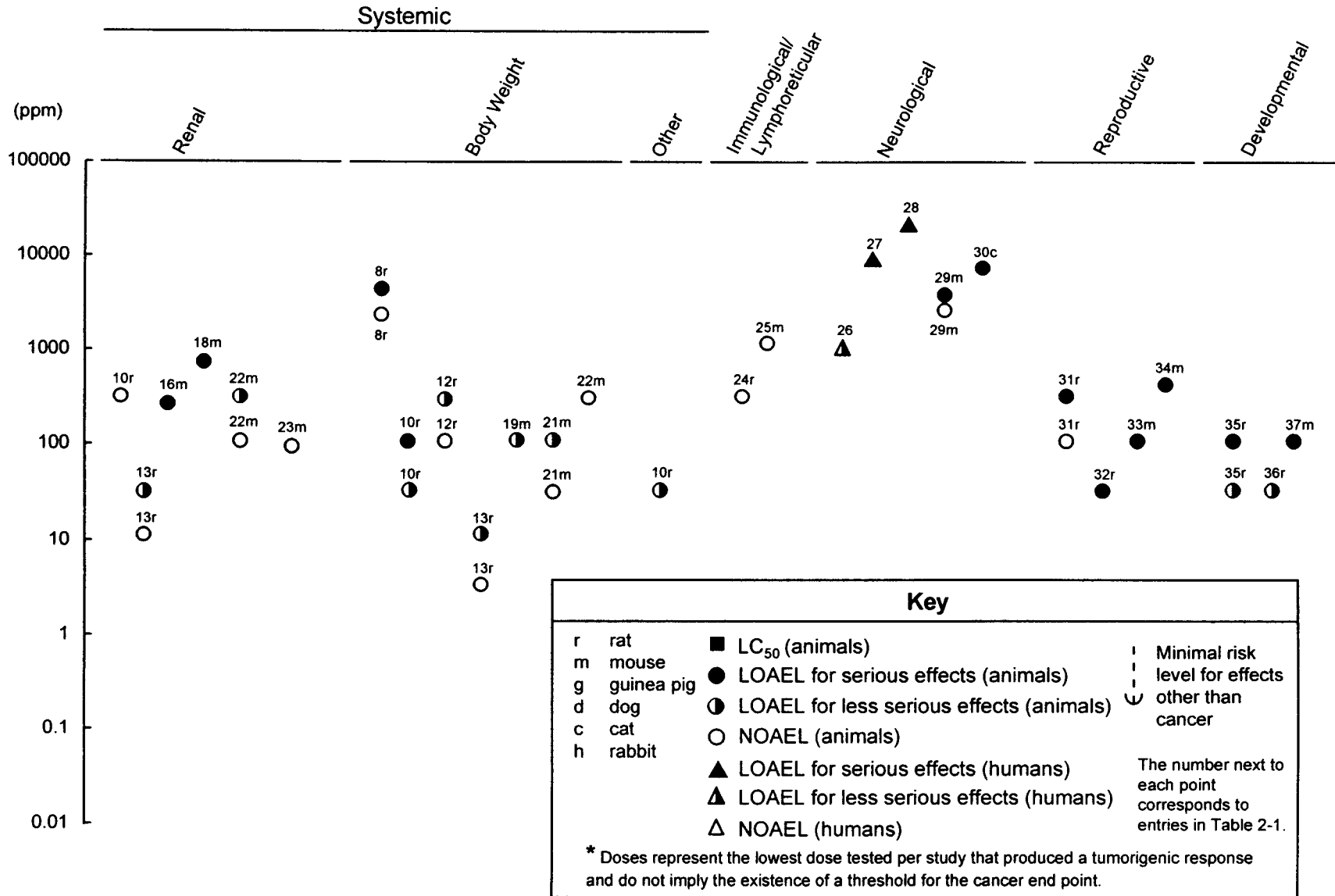
<sup>d</sup>Used to derive a chronic-duration inhalation MRL of 0.02 ppm; concentration is divided by an uncertainty factor 100 (10 for use of a LOAEL and 10 for human variability).

Bd Wt = body weight; Cardio = cardiovascular; d = day(s); F = female; Gastro = gastrointestinal; Gd = gestational day; Gn pig = guinea pig; GOT = glutamic oxalotransaminase; GPT = glutamic pyruvic transaminase; GSH = glutathione; Hemato = hematological; hr = hour(s); LC<sub>50</sub> = lethal concentration, 50% kill; LOAEL = lowest-observed-adverse-effect level; LI = labeling index; M = male; min = minute(s); mo = moth(s); musc/skel = musculoskeletal; NOAEL = no-observed-adverse-effect level; NS = not specified; Resp = respiratory; SDH = sorbitol dehydrogenase; SGPT = serum glutamic pyruvic transaminase; wk = week; yr = year(s)

**Figure 2-1. Levels of Significant Exposure to Chloroform - Inhalation**  
**Acute (≤14 days)**

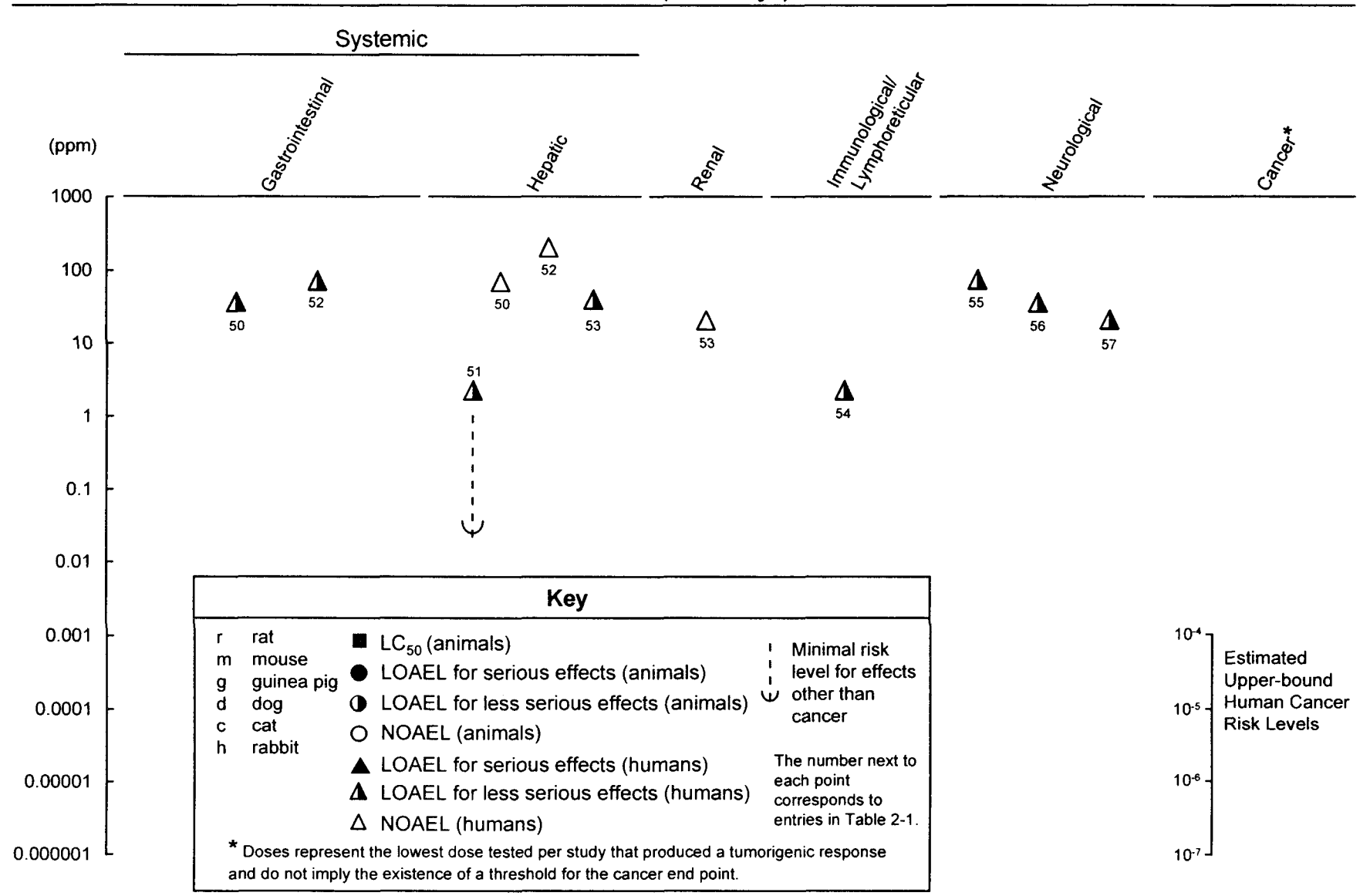


**Figure 2-1. Levels of Significant Exposure to Chloroform - Inhalation (cont.)**  
**Acute ( $\leq 14$  days)**





**Figure 2-1. Levels of Significant Exposure to Chloroform - Inhalation (cont.)**  
**Chronic ( ≥365 days)**



## 2. HEALTH EFFECTS

did not exceed 2.25%. No other studies were located regarding respiratory effects in humans after inhalation exposure to chloroform.

Larson et al. (1996) investigated the ability of acute exposure to chloroform vapors to produce toxicity and regenerative cell proliferation in the liver, kidneys, and nasal passage of female B6C3F<sub>1</sub> mice. Groups of 5 animals were exposed to 0, 0.3, 2, 10, 30, or 90 ppm chloroform via inhalation for 6 hours a day for 4 consecutive days. Animals were administered bromodeoxyuridine (BrdU) via implanted osmotic pump for the last 3.5 days. At necropsy, livers and kidneys were removed, weighed, examined macroscopically, and prepared for microscopic evaluation. The nasal cavities were also removed and prepared for microscopic evaluation. Cell proliferation was quantitated as the percentage of cells in S-phase (labeling index = LI) measured by immunohistochemical detection of BrdU-labeled nuclei. This study found no overt clinical signs of toxicity in female mice exposed to chloroform for 4 days; however, some mild, transient changes occurred in the posterior ventral areas of nasal tissue in female mice exposed to the 10, 30, and 90 ppm concentrations of chloroform. The lesions were characterized by mild proliferative responses in the periosteum consisting of a thickening of the bone. The adjacent lamina also exhibited loss of acini of Bowman's glands and vascular congestion. No microscopic changes were noted in nonnasal bones, nor were nonnasal bone LIs significantly different from those of controls.

Another similar study by Larson et al. (1994c) using a wider range of inhaled doses investigated the ability of chloroform vapors to produce toxicity and regenerative cell proliferation in the liver and kidneys of female B6C3F<sub>1</sub> mice and male Fischer 344 rats, respectively. Nasal passages were also examined for toxic response. Groups of 5 animals were exposed to 0, 1, 3, 10, 30, 100, or 300 ppm chloroform via inhalation for 6 hours a day for 7 consecutive days. Actual exposure concentrations measured were 0, 1.2, 3, 10, 29.5, 101, and 288 ppm for mice; and 0, 1.5, 3.1, 10.4, 29.3, 100, and 271 ppm and for rats. Animals were administered BrdU via implanted osmotic pump for the last 3.5 days to quantitate S-phase cell proliferation using an LI method. Necropsies were performed on day 8. No histopathological lesions were observed in the nasal passages of female mice at any exposure concentration. In the nasal passages of rats, chloroform concentrations of 10 ppm and above induced histopathological changes that exhibited a clear concentration-related response. These lesions consisted of respiratory epithelial goblet cell hyperplasia and degeneration of Bowman's glands in olfactory mucosa with an associated osseous hyperplasia of the endo- and ectoturbinates in the periphery of the ethmoid region.



## 2. HEALTH EFFECTS

Acute exposure to chloroform clearly can induce site-specific as well as biochemical changes in the nasal region of female B6C3F<sub>1</sub> mice and male Fischer 344 rats (Mery et al. 1994). To demonstrate the biochemical alterations, mice were exposed to 1.2, 3, 10, 29.5, 101, and 288 ppm chloroform and rats were exposed to 1.5, 3.1, 10.4, 29.3, 100, and 271 ppm for 6 hours a day for 7 days to determine the nasal cavity site-specific lesions and the occurrence of cell induction/proliferation associated with these varying concentrations of chloroform. In male rats, the respiratory epithelium of the nasopharyngeal meatus exhibited an increase in the size of goblet cells at 100 and 271 ppm chloroform, in addition to an increase in both neutral and acidic mucopolysaccharides. Affected epithelium was up to twice its normal thickness. New bone formation within the nasal region was prominently seen at 10.4 ppm and above, and followed a concentration response curve. At 29.3 and 100 ppm, new osseous spicules were present at the beginning of the first endoturbinat, while at 271 ppm, the width of the new bone was almost doubled compared to controls. The Bowman's glands were markedly reduced in size. Cytochrome P-450-2E1 staining was most prominent in the cytoplasm of olfactory epithelial sustentacular cells and in the acinar cells of Bowman's glands in control animals. In general, increasing the chloroform concentration tended to decrease the amount of P-450 staining in exposed animals. Exposure to chloroform resulted in a dramatic increase in the number of S-phase nuclei, with the proliferative response confined to activated periosteal cells, including both osteogenic (round) and preosteogenic (spindle) cells. The proximal and central regions of the first endoturbinat had the highest increase of cell proliferation. Interestingly, the only detectable treatment-related histologic change observed in female mice was a slight indication of new bone growth in the proximal part of the first endoturbinat in one mouse exposed to 288 ppm chloroform. The S-phase response was observed at chloroform concentrations of 10.4 ppm and higher. If similar nasal cavity changes occur in humans, the sense of smell could potentially be altered.

In some animal species, the lung may be a target organ when inhalation exposure to chloroform is of intermediate duration. Interstitial pneumonitis was observed in male rats and rabbits exposed to 85 ppm and in female rabbits exposed to 25 ppm chloroform for 6 months (Torkelson et al. 1976). The NOAEL was 50 ppm for male rats and rabbits. No respiratory changes were reported in guinea pigs and dogs exposed to 85 and 25 ppm chloroform, respectively.

Larson et al. (1996) investigated the ability of intermediate exposure to chloroform vapors to produce toxicity and regenerative cell proliferation in the nasal passage of male and female B6C3F<sub>1</sub> mice. Groups of 8 animals of each sex were exposed to 0, 0.3, 2, 10, 30, or 90 ppm chloroform via

## 2. HEALTH EFFECTS

inhalation for 6 hours a day, 7 days a week for 3, 6, or 13 weeks; additional groups of 8 animals of each sex were exposed for 6 hours a day, 5 days a week for 13 weeks. Animals were administered BrdU via implanted osmotic pump and cell proliferation was quantitated as the percentage of cells in S-phase using LI (measuring by immunohistochemical detection of BrdU-labeled nuclei). At necropsy, the nasal cavities were removed and prepared for microscopic evaluation. No alterations in nasal tissues were noted at any exposure level in either sex after exposures of 3, 6, or 13 weeks.

**Cardiovascular Effects.** Epidemiologic studies indicate that chloroform causes cardiac effects in patients under anesthesia. In a cohort of 1,502 patients (exposure less than 22,500 ppm), dose-related bradycardia developed in 8% of the cases, and cardiac arrhythmia developed in 1.3% of the cases (Whitaker and Jones 1965). Hypotension was observed in 27% of the patients and was related to the duration of the anesthesia and to pretreatment with thiopentone. Chloroform anesthesia (exposure 8,000-10,000 ppm) caused arrhythmia (nodal rhythm, first degree atrio-ventricular block, or complete heart block) in 50% of the cases from the cohort of 58 patients and hypotension in 12% (Smith et al. 1973). It should be noted that the effects seen may be secondary to surgical stress or the underlying disease which necessitated the surgical procedure.

No studies were located regarding cardiovascular effects in animals after inhalation exposure to chloroform.

**Gastrointestinal Effects.** Nausea and vomiting were frequently observed side effects in humans exposed to chloroform via anesthesia (exposure 8,000-22,500 ppm) (Royston 1924; Smith et al. 1973; Townsend 1939; Whitaker and Jones 1965). Nausea and vomiting were observed in male and female workers exposed solely to 14-400 ppm chloroform for 1-6 months (Phoon et al. 1983). Similarly, gastrointestinal symptoms (nausea, dry mouth, and fullness of the stomach) were reported in female workers occupationally exposed to 22-71 ppm chloroform for 10-24 months and 77-237 ppm chloroform for 3-10 years (Challen et al. 1958).

No studies were located regarding gastrointestinal effects in animals after inhalation exposure to chloroform.

**Hematological Effects.** The hematological system does not appear to be a significant target after inhalation exposure to chloroform. Except for increased prothrombin time in some individuals after

## 2. HEALTH EFFECTS

anesthesia exposure to 8,000 ppm, no hematological effects were observed in humans after inhalation exposure to chloroform (Smith et al. 1973). This effect reflects the hepatotoxicity of chloroform because prothrombin is formed in the liver.

No hematological effects were observed in rats, rabbits, and guinea pigs exposed to 85 ppm chloroform or in dogs exposed to 25 ppm chloroform for intermediate durations (Torkelson et al. 1976).

**Musculoskeletal Effects.** Few musculoskeletal effects have been reported in the literature after an acute, intermediate, or chronic exposure to chloroform in humans or in laboratory animals. Larson et al. (1996) investigated the ability of acute- and intermediate-duration exposure to chloroform vapor to produce toxicity and regenerative cell proliferation in various tissues of female B6C3F<sub>1</sub> mice. Using the methods described in previous sections of this profile, Larson et al. (1996) found that, after acute exposure, no microscopic changes were noted in nonnasal bones, nor were non nasal bone LIs different from those of controls. In the intermediate duration studies, no alterations in nonnasal bone tissues were noted at any exposure level in either sex after exposures of 3, 6, or 13 weeks.

**Hepatic Effects.** Chloroform-induced hepatotoxicity is one of the major toxic effects observed in both humans and animals after inhalation exposure. Increased sulfobromophthalein retention was observed in some patients exposed to chloroform via anesthesia (exposure 8,000-10,000 ppm), indicating impaired liver function (Smith et al. 1973). Serum transaminase, cholesterol, total bilirubin, and alkaline phosphatase levels were not affected. Transient jaundice has also been reported in one study (Whitaker and Jones 1965), while several earlier studies report acute hepatic necrosis in women exposed to chloroform via anesthesia (exact exposure not provided) during childbirth (Lunt 1953; Royston 1924; Townsend 1939). The effects observed in the women included jaundice, liver enlargement and tenderness, delirium, coma, and death. Centrilobular necrosis was found at autopsy in those who died. Workers exposed to 14-400 ppm chloroform for 1-6 months developed toxic hepatitis and other effects including jaundice, nausea, and vomiting, without fever (Phoon et al. 1983). The workers were originally diagnosed with viral hepatitis; however, in light of epidemiologic data, the diagnosis was changed to toxic hepatitis. No clinical evidence of liver injury was observed in workers exposed to as much as 71 and 237 ppm chloroform for intermediate and chronic durations, respectively; however, liver function was not well characterized (Challen et al. 1958). In contrast, toxic hepatitis (with hepatomegaly, enhanced serum glutamic pyruvic transaminase [SGPT] and serum

## 2. HEALTH EFFECTS

glutamic oxaloacetic transaminase [SGOT] activities, and hypergammaglobulinemia) was observed in workers exposed to 2-205 ppm chloroform (Bomski et al. 1967). Co-exposure to trace amounts of other solvents was also detected, however. Elevated serum prealbumin and transferrin were noted in another study (Li et al. 1993); however, the data is questionable as the exposed individuals most likely received exposures to toxic substances other than just chloroform. An intermediate-duration inhalation MRL of 0.05 ppm was derived from the LOAEL of 14 ppm from the data presented by Phoon et al. (1983); a chronic-duration inhalation MRL of 0.02 ppm was derived from the LOAEL of 2 ppm from the data presented by Bomski et al. (1967). More information on these MRLs and how they were derived is located in the footnote to Table 2-1, Section 2.5 and in Appendix A of this profile.

A study by Aiking et al. (1994) examined the possible hepatotoxicity of chloroform exposure in competitive swimmers who trained in indoor chlorinated swimming pools (n=10) compared to those who trained in outdoor chlorinated swimming pools (n=8). The actual amount of chloroform inhaled was not determined; however, the mean concentration of chloroform was determined to be 24 µg/L in the indoor pools and 18.4 µg/L in the outdoor pools. Mean blood chloroform concentration in the indoor pool swimmers was found to be 0.89 µg/L, while the control group and the outdoor pool swimmers had blood chloroform concentrations of less than 0.5 µg/L, suggesting that the chloroform could not be removed by environmental air currents (resulting in higher exposure dose) as it did in an outdoor pool environment. No significant differences in liver enzyme function was seen between any of the groups.

Chloroform-induced hepatotoxicity in various animal species has been reported in several studies. No changes in SGPT activity were observed in rats exposed to 300 ppm chloroform during gestation days (Gd) 6-15 (Schwetz et al. 1974). No changes in liver weights were found in pregnant Wistar rats that were exposed to 0, 30, 100, or 300 ppm chloroform via inhalation during Gd 7-16, followed by termination on day 21 (Baeder and Hofmann 1988). In contrast, serum sorbitol dehydrogenase (SDH) activity was increased in rats exposed to 153 ppm and above for 4 hours (Lundberg et al. 1986) and SGPT levels were increased in mice exposed to 100 ppm, 7 hours a day for 8 days during various stages of pregnancy (Murray et al. 1979) and 4,500 ppm for 9 hours (Gehring 1968). These increased enzyme levels in serum indicate hepatocellular necrosis. Fatty changes were observed microscopically in male and female mice after acute exposure to chloroform concentrations  $\geq 100$  ppm (Culliford and Hewitt 1957; Kylin et al. 1963). Elevated liver triglycerides and liver glutathione (GSH) have also been reported (Ikatsu and Nakajima 1992). Liver necrosis was observed in female rats exposed to

## 2. HEALTH EFFECTS

4,885 ppm chloroform for 4 hours (Lundberg et al. 1986) and in male mice that died after acute exposure to 692-1,106 ppm chloroform (Deringer et al. 1953). Centrilobular granular degeneration was observed in rats, rabbits, and guinea pigs exposed to 25 ppm chloroform for 6 months, but not in dogs exposed to 25 ppm for the same time period (Torkelson et al. 1976); however, these pathological findings were not observed in the 50 ppm exposure group of rabbits and guinea pigs, or in the 85 ppm exposure group of guinea pigs. Although the liver effects in rabbits and guinea pigs were not dose-related, the small number of surviving animals in the higher exposure group may have biased the results of the study and may not fully describe the pathological effects of chloroform at the higher dose.

In two separate studies, Wang et al. (1994, 1995) investigated the effect of ethanol consumption or fasting, respectively, on the metabolism and toxicity of chloroform administered by inhalation of an acute duration. In the first study, male Wistar rats were pretreated with either ethanol, 2,000 mg/kg, or water. Eighteen hours later, the animals were exposed to air containing chloroform at concentrations of 0, 50, 100, or 500 ppm for 6 hours (5 rats a group). At 24 hours postexposure, animals were anesthetized, blood samples were collected for determination of SGOT and SGPT levels; livers were harvested and processed for determination of GSH levels. Chloroform produced dose-dependent hepatotoxicity, and ethanol pretreatment enhanced this effect. In rats exposed by inhalation, hepatotoxicity was only evident at the highest dose (500 ppm); SGOT and SGPT values in treated rats were 47 and 24 international units per liter (IU/L) versus 30 and 16 IU/L in controls, respectively. GSH concentrations in rats exposed to chloroform were lowered in a dose-dependent manner. Significant ( $p < 0.05$ ) reductions were seen at the 500 ppm dose in rats exposed by inhalation. In the second study, rats were divided in two groups: those fasted over night and those allowed free access to food. The following day, 5 rats per group were exposed to chloroform once by inhalation at 0, 50, 100, or 500 ppm for 6 hours. Twenty-four hours after exposure, blood samples were collected for SGOT and SGPT determinations. Chloroform tended to produce hepatotoxicity in a dose-dependent manner, and fasting tended to potentiate the toxicity. Plasma SGOT activity was significantly elevated in the fasting group at 100 and 500 ppm and the fed group at 500 ppm as compared to controls. SGPT levels in the fasting group exposed to 500 ppm chloroform (212 IU/L) significantly exceeded those of the fasting control group (16 IU/L). GSH levels in the fasting group exposed to 500 ppm chloroform (2.22 mg/g) were significantly lower than those of the fasted control group (2.51 mg/g).

## 2. HEALTH EFFECTS

Larson et al. (1996) investigated the ability of acute chloroform vapor exposure to produce toxicity and regenerative cell proliferation in the liver of female B6C3F<sub>1</sub> mice. Groups of 5 animals were exposed to 0, 0.3, 2, 10, 30, or 90 ppm chloroform via inhalation for 6 hours a day for 4 consecutive days. Animals were administered BrdU via an implanted osmotic pump, and cell proliferation was quantitated as the percentage of cells in S-phase (LI) measured by immunohistochemical detection of BrdU-labeled nuclei. At necropsy, livers were removed, weighed, examined macroscopically, and prepared for microscopic evaluation. Exposure to 90 ppm chloroform resulted in increased relative liver weights. Female mice exposed to chloroform for 4 days experienced a dose-dependent mild response of uniform hepatocyte lipid vacuolization. Scattered individual hepatocyte necrosis also occurred in a dose-dependent manner. Hepatic LI was significantly elevated in female mice in the 90 ppm dose group after 4 days exposure (9-fold;  $p < 0.05$ ).

In an earlier study, Larson et al. (1994c) investigated the ability of chloroform vapors to produce toxicity and regenerative cell proliferation in the liver and kidneys of female B6C3F<sub>1</sub> mice and male Fischer 344 rats, respectively. Groups of 5 animals were exposed to 0, 1, 3, 10, 30, 100, or 300 ppm chloroform via inhalation for 6 hours a day for 7 consecutive days. Actual exposure concentrations measured for mice were 0, 1.2, 3, 10, 29.5, 101, and 288 ppm and for rats were 0, 1.5, 3.1, 10.4, 29.3, 100, and 271 ppm. Necropsies were performed on day 8. Animals were administered BrdU via implanted osmotic pump for the last 3.5 days in order to measure S-phase cell proliferation using an LI method. Female mice exposed to 101 or 298 ppm exhibited centrilobular hepatocyte necrosis and severe diffuse vacuolar degeneration of mid-zonal and periportal hepatocytes, while exposure to 10 or 29.5 ppm resulted in mild-to-moderate vacuolar changes in centrilobular hepatocytes. Specifically, decreased eosinophilia of the centrilobular and mid-zonal hepatocyte cytoplasm relative to periportal hepatocytes was observed at 29.5 ppm. Livers of mice in the 1 and 3 ppm groups did not differ from controls. Slight, dose-related increases in the hepatocyte LIs were observed in the 10 and 30 ppm dose groups, while the LI was increased more than 30-fold in the 101 and 288 ppm groups. Relative liver weights were increased in a dose-dependent manner at exposures of 3 ppm and above. Livers from mice exposed to 101 or 288 ppm were enlarged and pale. In male rats, swelling and mild centrilobular vacuolation was observed only in the livers of rats exposed to 271 ppm. Necrosis was minimal and confined to individual hepatocytes immediately adjacent to the central vein; livers were dark red and congested. The hepatocyte LI in rats were increased only at 101 and 271 ppm, 3- and 7-fold over controls, respectively. An acute-duration inhalation MRL of 0.1 ppm was based on the

## 2. HEALTH EFFECTS

NOAEL of 3 ppm for hepatic effects in mice. More information on this MRL and how it was derived is located in the footnote to Table 2-1, Section 2.5 in Appendix A this profile.

Larson and coworkers (1996) investigated the ability of intermediate-duration chloroform vapor exposure to produce toxicity and regenerative cell proliferation in the liver of male and female B6C3F<sub>1</sub> mice. Groups of 8 animals of each sex were exposed to 0, 0.3, 2, 10, 30, or 90 ppm chloroform via inhalation for 6 hours a day, 7 days a week for 3, 6, or 13 weeks; additional groups of 8 animals of each sex were exposed for 6 hours a day, 5 days a week for 13 weeks. Animals were administered BrdU via implanted osmotic pump and cell proliferation was quantitated as the percentage of cells in S-phase. At necropsy, livers were removed, examined macroscopically, and then prepared for microscopic evaluation. In mice exposed for 3 weeks, no changes in relative liver weights occurred in males at any dose level, whereas females exposed to 90 ppm chloroform experienced a significant increase (10.7%;  $p < 0.05$ ) in relative liver weights. Liver lesions were noted in males and females at exposures of 30 and 90 ppm. Lesions were characterized by vacuolation and swelling of hepatocytes and variations in nuclear size. Cell proliferation was elevated in the livers of females and males at 30 and 90 ppm exposures, respectively. In mice exposed for 6 weeks, exposure to 90 ppm chloroform resulted in a significant increase (16.1%;  $p < 0.05$ ) in relative liver weights. Liver lesions were noted in females at exposures of 30 and 90 ppm; these lesions were characterized by mild degenerative changes in hepatocytes. An increase in liver LI was also noted in the females exposed to 30 and 90 ppm chloroform. In mice exposed 7 days a week for 13 weeks, relative liver weights increased in males exposed to 30 and 90 ppm chloroform and in females exposed to 90 ppm chloroform ( $p < 0.05$ ). Liver lesions were elevated above background in males and females at exposures of 30 and 90 ppm. Lesions were characterized by vacuolation and swelling of hepatocytes and variations in nuclear size. Cell proliferation was elevated in the livers of females and males at exposed to 90 ppm chloroform. Hepatic alterations in mice exposed 5 days a week for 13 weeks were similar to those of mice exposed 7 days a week; however, the severity of the lesions was diminished with significant effects seen only at the 90 ppm exposure level.

**Renal Effects.** Several studies regarding kidney toxicity effects in humans after inhalation exposure to chloroform were found. No biochemical renal anomalies were reported in one study examining factory workers in China exposed to varying levels of chloroform (Li et al. 1993). One report was obtained from case reports of death among women exposed to chloroform via anesthesia during childbirth (Royston 1924). The fatty degeneration of kidneys observed at autopsy indicated

## 2. HEALTH EFFECTS

chloroform-induced damage. A study by Aiking et al. (1994) examined the possible renal toxicity of chloroform exposure in competitive swimmers who trained in indoor and outdoor chlorinated swimming pools in the Netherlands. Although no significant differences in liver enzyme function were seen between any of the groups, the study did determine that  $\beta$ -2-microglobulin was elevated in the indoor pool swimmers (after controlling for possible age bias using multiple regression analysis), suggesting some degree of renal damage due to higher inhaled air concentrations of chloroform present in the air of indoor swimming pools.

In animals, the kidney is one of the target organs of inhalation exposure to chloroform. Groups of 20 female Wistar rats were exposed to 0, 30, 100, or 300 ppm chloroform via inhalation during Gd 7-16 and terminated on day 21 showed no changes in kidney weights compared to control animals (Baeder and Hofmann 1988). Larson et al. (1996) investigated the ability of acute chloroform vapor exposure to produce toxicity and regenerative cell proliferation in the kidneys of female B6C3F<sub>1</sub> mice. Groups of 5 animals were exposed to 0, 0.3, 2, 10, 30, or 90 ppm chloroform via inhalation for 6 hours a day for 4 consecutive days. At necropsy, kidneys were removed, weighed, examined macroscopically, and prepared for microscopic evaluation. Relative kidney weights were similar to controls at all chloroform exposure levels. Kidneys of female mice exposed to chloroform were not different from those of controls at any dose. Exposure to chloroform did not significantly affect the kidney cortex LI in females at any dose.

In an earlier study, Larson et al. (1994~) examined the ability of chloroform vapors to produce toxicity and regenerative cell proliferation in the liver and kidneys of female B6C3F<sub>1</sub> mice and male Fischer 344 rats, respectively. Groups of 5 animals were exposed to 0, 1, 3, 10, 30, 100, or 300 ppm chloroform via inhalation for 6 hours a day for 7 consecutive days. Actual exposure concentrations measured for mice were 0, 1.2, 3, 10, 29.5, 101, and 288 ppm and for rats were 0, 1.5, 3.1, 10.4, 29.3, 100, and 271 ppm. Necropsies were performed on day 8. The kidneys of mice were affected only at the 300 ppm exposure, with approximately half of the proximal tubules lined by regenerating epithelium and an increased LI of tubule cells of 8-fold over controls. In the kidneys of male rats exposed to 300 ppm, about 25-50% of the proximal tubules were lined by regenerating epithelium. The LI for tubule cells in the cortex was increased at 30 ppm and above.



## 2. HEALTH EFFECTS

Tubular necrosis was observed in male mice after acute exposure to chloroform concentrations  $\geq 246$  ppm (Culliford and Hewitt 1957; Deringer et al. 1953). Tubular calcifications were observed in mice that survived the exposure and were terminated after a 12-month recovery period.

In a study of intermediate duration, increased kidney weight (both sexes) and cloudy swelling (males) were observed in rats exposed to chloroform concentrations  $\geq 25$  ppm chloroform (Torkelson et al. 1976). Results were not consistent in rabbits and guinea pigs under the same exposure conditions. Cloudy swelling, and tubular and interstitial nephritis were observed in groups of rats exposed to 25 ppm chloroform, but not in groups exposed to 50 ppm. The results in rabbits and guinea pigs, however, may be biased due to the low survival rate at the higher exposure level.

Larson and coworkers (1996) also investigated the ability of intermediate-duration chloroform vapor exposure to produce toxicity and regenerative cell proliferation in the kidneys of male and female B6C3F<sub>1</sub> mice. Groups of 8 animals of each sex were exposed to 0, 0.3, 2, 10, 30, or 90 ppm chloroform via inhalation for 6 hours a day, 7 days a week for 3, 6, or 13 weeks; additional groups of 8 animals of each sex were exposed for 6 hours a day, 5 days a week for 13 weeks. At necropsy, kidneys were removed, examined macroscopically, and prepared for microscopic evaluation. In mice exposed for 3 weeks, no changes were noted in relative kidney weights in either sex at any exposure level. While kidneys of female mice did not differ from those of controls at any dose, those of males were significantly affected by chloroform exposures of 30 ppm or more. Lesions were mainly in the epithelial cells of the proximal convoluted tubules, with 25 and 50% of cells affected in the 30 and 90 ppm groups, respectively. Cell proliferation was elevated in males at the 30 ppm exposure level, while female kidney LIs were not affected at any exposure level. In mice exposed for 6 weeks, no changes were noted in relative kidney weights at any exposure level. Kidneys from exposed females were not histologically different from controls at any exposure level, and kidney LIs were similar to control values at all exposure levels. In mice exposed 7 days a week for 13 weeks, no changes were noted in relative kidney weights in either sex at any exposure level. While kidneys of female mice did not differ from those of controls at any dose, those of males were significantly affected by chloroform exposures of 10 ppm or more. Lesions were mainly in the epithelial cells of the proximal convoluted tubules, with 25 and 50% of cells affected in the 30 and 90 ppm groups, respectively. Mineralization within the cortex and enlarged nuclei in the epithelial cells were also noted. Cell proliferation was elevated in the cortical tissues of males at the 30 and 90 ppm exposure level; in contrast, female

## 2. HEALTH EFFECTS

kidney LIs were not affected at any exposure level. In contrast, exposure to chloroform vapors 5 days a week for 13 weeks produced no adverse renal effects.

**Body Weight Effects.** No studies were located regarding body weight effects in humans after inhalation exposure to chloroform.

Larson et al. (1994c) noted that in female B6C3F<sub>1</sub> mice and male Fischer 344 rats exposed to 0, 1, 3, 10, 30, 100, or 300 ppm chloroform via inhalation for 6 hours a day for 7 consecutive days that body weight gains were significantly decreased relative to controls in mice exposed to 101 and 288 ppm (1% weight loss at 101 and 288 ppm). Body weight gain was significantly decreased in a concentration-dependent manner in rats exposed to 10 ppm of chloroform and above (2% weight loss at 271 ppm; weight gains of 9-12% at 10.4-101 ppm, as compared to 18% weight gain by controls).

A dose-dependent reduction in feed consumption, resulting in decreased body weight gain, was observed in pregnant female rats exposed to 30 ppm chloroform (7 hours a day for 10 days) and above during gestation (Baeder and Hofmann 1988). Newell and Dilley (1978) report that maternal body weights decreased in Sprague-Dawley rats when the chloroform concentration reached 4,117 ppm when exposed for 1 hour a day during Gd 7-14. Similarly, decreased body weight was observed in pregnant mice exposed to 100 ppm chloroform during gestation (Murray et al. 1979). Decreased body weight was reported in male rats exposed to chloroform at 271 ppm for 6 hours a day for 7 days; however, no discernable decrease in body weight was noted at concentrations from 1.5 to 100 ppm. Decreases in body weight were also noted in female mice exposed to 101 ppm chloroform for the same duration (Mery et al. 1994). Decreased body weight also occurred in male rats exposed to 50 ppm for 6 months (Torkelson et al. 1976).

Larson and coworkers (1996) also investigated the effect of intermediate exposure to chloroform vapor on body weight in male and female B6C3F<sub>1</sub> mice. Groups of 8 animals of each sex were exposed to 0, 0.3, 2, 10, 30, or 90 ppm chloroform via inhalation for 6 hours a day, 7 days a week for 3, 6, or 13 weeks; additional groups of 8 animals of each sex were exposed for 6 hours a day, 5 days a week for 13 weeks. In mice exposed 7 days a week for 3 weeks, body weights in females were unaffected, while those of males exposed to 90 ppm chloroform were significantly lower compared to controls (2% weight loss versus 6% weight gain). Exposure to chloroform 7 days a week for 6, or 13 weeks did not affect body weights in males or females; however, when exposed 5 days a week for 13 weeks,

## 2. HEALTH EFFECTS

body weight gains in males and females exposed to 90 ppm chloroform were slightly reduced compared to their respective controls (93 and 91%, respectively).

**Other Systemic Effects.** No studies were located regarding other systemic effects in humans after inhalation exposure to chloroform.

Gearhart et al. (1993) studied the interactions of chloroform exposure with body temperature in mice. Male mice were exposed to chloroform concentrations up to 5,500 ppm chloroform for 6 hours and their core body temperature monitored. The largest decrease in core body temperature was observed in the 5,500 ppm exposure group, followed by the 2,000, 800, and 100 ppm groups. There was no significant decrease in *in vitro* cytochrome P-450 activity at any temperature tested. The data collected were used to develop a PBPK model, which is discussed in more detail in Section 2.3.5. Decreased feed consumption also been reported at chloroform doses as low as 30 ppm in rats (Baeder and Hofmann 1988).

### 2.2.1.3 Immunological and Lymphoreticular Effects

No studies were located regarding in-depth immunological effects in humans after inhalation exposure to chloroform. Only one study (Bomski et al. 1967) described the health effects of a group of 68 workers occupationally exposed to chloroform for 1-4 years in a pharmaceutical plant. Chloroform air concentrations ranged from 0.01 to 1 mg/L, and other solvents were also reported in the air in trace amounts. Splenomegaly was the only immunologically detected health effect in a small percentage of these cases.

Chloroform appears to have little effect on the spleen of laboratory animals. No histological changes were found in the spleen of mice exposed to chloroform concentrations as high as 1,106 ppm for 1-3 hours (Deringer et al. 1953) or in male rats receiving 25 ppm of chloroform for 6 months (Torkelson et al. 1976). Female Wistar rats exposed to 0, 30, 100, or 300 ppm chloroform for 10 days via inhalation during Gd 7-16 also failed to show a change in maternal spleen organ weights (Baeder and Hofmann 1988).

Other information on the immunotoxicity of chloroform is limited to one study on effects of chloroform on host resistance in CD-1 mice. A single exposure to 10.6 ppm chloroform for 3 hours

## 2. HEALTH EFFECTS

did not increase the mortality rate after streptococcal challenge and did not alter the ability of alveolar macrophages to destroy bacteria in these mice (Aranyi et al. 1986). After repeated chloroform exposure (3 hours a day for 5 days), the mortality rate significantly increased, but the bactericidal activity of macrophages was not suppressed compared to control animals.

### 2.2.1.4 Neurological Effects

The central nervous system is a major target for chloroform toxicity in humans and in animals. Chloroform was once widely used as an anesthetic during surgery in humans, but is not currently used as a surgical inhalant anesthetic in modern-day medical practice. Levels of 3,000-30,000 ppm were used to induce anesthesia (Featherstone 1947; Smith et al. 1973; Whitaker and Jones 1965). Concentrations of  $\approx 40,000$  ppm, if continued for several minutes, could result in death (Featherstone 1947). To induce anesthesia, increasing the concentration of chloroform gradually to 25,000 or 30,000 ppm during the first 2 or 3 minutes with maintenance at much lower levels was recommended. Concentrations  $< 1,500$  ppm are insufficient to induce anesthesia; concentration of 1,500-2,000 ppm cause light anesthesia (Goodman and Gilman 1980).

Dizziness and vertigo were observed in humans after exposure to 920 ppm chloroform for 3 minutes; headache and slight intoxication were observed at higher concentrations (Lehmann and Hasegawa 1910). Exhaustion was reported in 10 women exposed to  $\geq 22$  ppm chloroform during intermediate and chronic-duration occupational exposures (Challen et al. 1958). Chronic exposure to chloroform concentrations  $\geq 77$  ppm caused exhaustion, lack of concentration, depression, or irritability in 9 of 10 occupationally exposed women. A case report of an individual addicted to chloroform inhalation for  $\approx 12$  years reported psychotic episodes, hallucinations and delusions, and convulsions (Heilbrunn et al. 1945). Withdrawal symptoms, consisting of pronounced ataxia and dysarthria, occurred following an abrupt discontinuation of chloroform use. Moderate, unspecified, degenerative changes were observed in the ganglion cells in the putamen and the cerebellum at autopsy. Death resulted from an unrelated disease.

A study of 61 workers exposed for 1-15 years (average 7.8 years) attempted to delineate a possible exposure-effect relationship and to determine the toxicity of chloroform after long-term exposures at a low concentrations in factories in China (Li et al. 1993). Concentrations of chloroform ranged from 0.87 to 28.9 ppm. Dizziness, fatigue, somnolence, insomnia, increased dreaming, hypomnesia,

## 2. HEALTH EFFECTS

anorexia, and palpitations were significantly elevated in these individuals. Depression, anger, and fatigue were also reported to be significantly elevated. Significant changes were found in neurologic testings of Simple Visual Reaction Time, Digital Symbol Substitution, Digit Span, Benten Retention and Aim Pursuing in some workers. A limitation of this study was that the exposed group, based on information indicating where the exposed groups originated, indicated that these individuals probably inhaled much more than just chloroform (i.e., other solvents, drugs, pesticides, etc.) and all the effects attributed to chloroform may be attributable to other chemicals in addition to chloroform.

Evidence of central nervous system toxicity in animals includes disturbed equilibrium in cats exposed to 7,200 ppm chloroform for 5 minutes, deep narcosis in cats exposed to 21,500 ppm for 13 minutes, deep narcosis in mice exposed to 4,000 ppm for 30 minutes, slight narcosis in mice exposed to 3,100 ppm for 1 hour, and no obvious effects in mice exposed to 2,500 ppm for 2 hours (Lehmann and Flury 1943). Memory retrieval was affected in mice exposed to chloroform via anesthesia (concentration not specified) (Valzelli et al. 1988). The amnesic effect was not long-lasting.

The highest NOAEL value and all reliable LOAEL values for neurological effects in each species and duration category are recorded in Table 2-1 and plotted in Figure 2-1.

### 2.2.1.5 Reproductive Effects

No studies were located regarding reproductive effects in humans after inhalation exposure to chloroform.

Several studies indicate that inhalation exposure to chloroform may cause reproductive effects in animals. Rats exposed to chloroform during gestation had decreased conception rates after exposure to 300 ppm, but not after exposure to 100 ppm (Schwetz et al. 1974). Studies by Baeder and Hofmann (1988) indicated that exposure to as little as 30 ppm chloroform resulted in increased fetal resorptions. Similarly, a decreased ability to maintain pregnancy, characterized by an increased number of fetal resorptions and decreased conception rates, was observed in mice exposed to 100 ppm chloroform (Murray et al. 1979). In addition to the reproductive effects described above, a significant increase in the percentage of abnormal sperm was observed in mice exposed to 400 ppm chloroform for 5 days (Land et al. 1979).

## 2. HEALTH EFFECTS

In males, groups of 10-12 male rats (strain not reported) were exposed to 0, 25, 50, or 85 ppm chloroform for 6 months. Adjusted testicular weights in the 50 and 85 ppm groups were greater than those of their respective controls, but were not different from those of other control groups within the same colony. Additionally, no histological changes were noted in testicular tissues of treated animals. The significant increase in testes weights reported in this study was considered to be spurious not likely a direct effect of chloroform exposure (Torkelson et al. 1976).

The highest NOAEL value and all reliable LOAEL values for reproductive effects in each species in the acute-duration category are recorded in Table 2-1 and plotted in Figure 2-1.

### 2.2.1.6 Developmental Effects

No studies were located regarding developmental effects in humans after inhalation exposure to chloroform.

Chloroform-induced fetotoxicity and teratogenicity were observed in experimental animals. The offspring of rats exposed during gestation had delayed ossification and wavy ribs (30 ppm), acaudate fetuses with imperforate anus and missing ribs (100 ppm), and decreased fetal body weight and crown-rump length, and increased fetal resorptions (300 ppm) (Schwetz et al. 1974). Slight growth retardation of live fetuses at 30 ppm was observed in rats exposed during gestation; no major teratogenic effects were observed (Baeder and Hofmann 1988). The offspring of mice exposed to 100 ppm chloroform during gestation had increased incidences of cleft palate, decreased ossification, and decreased fetal crown-rump length (Murray et al. 1979). The observed malformations occurred in the fetuses that were exposed during organogenesis (days 8-15). Increased resorptions were observed in dams exposed during Gd 1-7.

In another study using relatively higher doses, female Sprague-Dawley rats were exposed to 0, 942, 2,232, or 4,117 ppm chloroform 8 days during Gd 7-14, for 1 hour a day. The number of resorptions was enhanced (45% resorptions) and average fetal body weights declined in the highest exposure group only, with no adverse effects noted in the 2,232 ppm and lower doses. The average fetal weight was decreased at the highest dose. No gross teratologic effects or anomalies in ossification were observed in the offspring of exposed dams (Newell and Dilley 1978).

## 2. HEALTH EFFECTS

All reliable LOAEL values for developmental effects in each species in the acute-duration category are recorded in Table 2-1 and plotted in Figure 2- 1.

### 2.2.1.7 Genotoxic Effects

No studies were located regarding genotoxic effects in humans after inhalation exposure to chloroform.

Inhalation exposure to 400 ppm chloroform for 5 days increased the percentage of abnormal sperm in mice (Land et al. 1979). Other genotoxicity studies are discussed in Section 2.5.

### 2.2.1.8 Cancer

No studies were located regarding cancer in humans or animals after inhalation exposure to chloroform.

Studies in animals indicate that oral exposure to chloroform causes cancer (see Section 2.2.2.8).

Because chloroform is carcinogenic in animals exposed orally and because chloroform has identical toxicological end points following oral or inhalation exposure, EPA (1985a) derived a  $q_1^*$  for inhalation exposure to chloroform based on mouse liver tumor data from a chronic gavage study (NCI 1976). EPA considered the NCI (1976) study to be appropriate to use in the inhalation risk estimate because there are no inhalation cancer bioassays and no pharmacokinetic data to contraindicate the use of gavage data (IRIS 1995). The geometric mean of the estimates for male and female mice in the NCI (1976) study,  $8 \times 10^{-2} \text{ (mg/kg/day)}^{-1}$ , was recommended as the inhalation  $q_1^*$  for chloroform. EPA (1985a) combined the estimates for both data sets because the data for males includes observations at a lower dose, which appear to be consistent with the female data. Expressed in terms of air concentration, the  $q_1^*$  is equal to  $2.3 \times 10^{-5} \text{ (}\mu\text{g/m}^3\text{)}^{-1}$  or  $1.1 \times 10^{-4}$  parts per billion (ppb)<sup>-1</sup>

The air concentrations associated with individual, lifetime upper-bound risks of  $10^{-4}$  to  $10^{-7}$  are  $4.3 \times 10^{-3}$  to  $4.3 \times 10^{-6} \text{ mg/m}^3$  ( $8.8 \times 10^{-4}$  to  $8.8 \times 10^{-7}$  ppm), assuming that a 70-kg human breathes  $20 \text{ m}^3$  air/day. The  $10^{-4}$  to  $10^{-7}$  levels are indicated in Figure 2- 1.

## 2. HEALTH EFFECTS

### 2.2.2 Oral Exposure

#### 2.2.2.1 Death

Information regarding mortality in humans after oral exposure to chloroform is limited. In one report, a man died of severe hepatic injury 9 days after reportedly drinking  $\approx 6$  ounces of chloroform (3,755 mg/kg) (Piersol et al. 1933). He was admitted to a hospital in a deep coma within 15 minutes of ingestion. This man was also noted to be a long-time user of chloroform in his occupation and a heavy drinker, suggesting that damage inflicted by previous use of chloroform and alcohol over a long period of time may have been contributing factors in his death. In contrast, a patient who ingested 4 ounces ( $\approx 2,410$  mg/kg) recovered from toxic hepatitis (Schroeder 1965). The recovery may have been due to better therapeutic handling of the case. Fatal doses have been reported to be as low as 10 mL (14.8 grams) or 212 mg/kg (Schroeder 1965).

Oral LD<sub>50</sub>, (lethal dose, 50% kill) values in animals vary greatly. No deaths occurred in rats exposed to once 0.1-0.5 mL/kg chloroform by gavage in oil (Nakajima et al. 1995). Acute LD<sub>50</sub> values of 2,000 mg/kg chloroform (Torkelson et al. 1976) and 2,180 mg/kg chloroform (Smyth et al. 1962) were reported for rats. LD<sub>50</sub> values in male rats varied with age: 446 mg/kg for 14-day-olds, 1,337 mg/kg for young adults, and 1,188 mg/kg for old adults (Kimura et al. 1971). LD<sub>50</sub> values were different for male rats (908 mg/kg/day) and female rats (1,117 mg/kg/day) (Chu et al. 1982b). Similarly, the LD<sub>50</sub> for male mice was lower (1,120 mg/kg) than for female mice (1,400 mg/kg) (Bowman et al. 1978). In general, young adult males had lower survival rates. In another study, an acute oral LD<sub>50</sub> value of 1,100 mg/kg/day was reported for male and female mice (Jones et al. 1958). Decreased survival rates were also observed in male mice exposed to 250 mg/kg/day chloroform for 14 days, but not in mice exposed to 100 mg/kg/day. Female mice, however, survived 500 mg/kg/day chloroform treatment (Gulati et al. 1988). Increased mortality was noted in 5 of 12 male mice exposed to 277 mg/kg/day in corn oil by gavage for 4 days (Larson et al. 1994d). Pregnant animals may be more susceptible to chloroform lethality. Increased mortality was observed in pregnant rats exposed to 516 mg/kg/day. Rabbits exposed to 63, 100, 159, 251, and 398 mg/kg/day chloroform during Gd 6-18 had increasing rates of mortality as the dose of chloroform increased (Thompson et al. 1974).

There was a high rate of mortality in rats exposed to 142 mg/kg/day chloroform in drinking water for 90 days and during a 90-day observation period. Histopathological examination revealed atrophy of



## 2. HEALTH EFFECTS

the liver and extensive squamous debris in the esophagus and gastric cardia. These changes suggested to the authors that the rats had died of starvation. Mortality was not increased in the 44 mg/kg/day group (Chu et al. 1982a). The vehicle and mode of administration may influence the lethality of chloroform in mice. In 90-day studies in mice, no effect on mortality was observed in groups treated by gavage with doses up to 250 mg/kg/day chloroform in oil (Munson et al. 1982) or with 435 mg/kg/day in drinking water (Jorgenson and Rushbrook 1980). The maximum tolerated dose of chloroform in drinking water was calculated as 306 mg/kg/day for mice (Klaunig et al. 1986). Survival was affected in mice exposed by gavage to 400 mg/kg/day chloroform in oil for 60 days, but not in those exposed to 100 mg/kg (Balster and Borzelleca 1982). Exposure to 150 mg/kg/day chloroform in toothpaste by gavage for 6 weeks caused death in 8 of 10 male mice (Roe et al. 1979). No death occurred in mice exposed to 149 mg/kg/day chloroform in oil for 30 days; there was an increased incidence of death in males exposed to 297 mg/kg/day (Eschenbrenner and Miller 1945a). No deaths occurred in dogs exposed to 120 mg/kg/day chloroform in toothpaste capsules for 12-18 weeks (Heywood et al. 1979).

Decreased survival was observed in rats exposed by gavage to concentrations  $\geq 90$  mg/kg/day chloroform in oil for 78 weeks and in female mice exposed to 477 mg/kg/day, but not in male mice exposed to 277 mg/kg/day time-weighted average (TWA) during the same time period (NCI 1976). In addition, no increase in compound-related mortality was observed in mice exposed by gavage to 60 mg/kg/day chloroform in toothpaste (Roe et al. 1979) in rats or mice exposed to  $\geq 160$  mg/kg/day chloroform in drinking water for chronic durations (Jorgenson et al. 1985; Klaunig et al. 1986). Similarly, mortality was not affected in dogs exposed to 30 mg/kg/day chloroform in toothpaste capsules for 7.5 years (Heywood et al. 1979).

The LD<sub>50</sub> and all reliable LOAEL values for death in each species and duration category are recorded in Table 2-2 and plotted in Figure 2-2.

### 2.2.2.2 Systemic Effects

No credible studies were located regarding ocular effects in humans or animals after oral exposure to chloroform. The other systemic effects of oral exposure to chloroform are discussed below. The highest NOAEL values and all reliable LOAEL values for each effect in each species and duration category are recorded in Table 2-2 and plotted in Figure 2-2.

Table 2-2. Levels of Significant Exposure to Chloroform - Oral

Key to <sup>a</sup> figure	Species/ (strain)	Exposure/ duration/ frequency (Specific route)	System	NOAEL (mg/kg/day)	LOAEL		Reference
					Less Serious (mg/kg/day)	Serious (mg/kg/day)	
<b>ACUTE EXPOSURE</b>							
<b>Death</b>							
1	Rat (Sprague- Dawley)	once (GO)				908 M (LD <sub>50</sub> )	Chu et al. 1982b
2	Rat (Sprague- Dawley)	once (G)				1117 F (LD <sub>50</sub> ) 1337 M (LD <sub>50</sub> for young adults)	Kimura et al. 1971
3	Rat (Wistar)	once (G)				1188 M (LD <sub>50</sub> for old adults) 446 M (LD <sub>50</sub> for 14-day olds) 2180 F (LD <sub>50</sub> )	Smyth et al. 1962
4	Rat (Sprague- Dawley)	10 d Gd 6-15 1-2 x/d (GO)				516 F (4/6 died)	Thompson et al. 1974
5	Rat (NS)	once (G)				2000 M (LD <sub>50</sub> )	Torkelson et al. 1976
6	Mouse (ICR Swiss)	once (GO)				1120 M (LD <sub>50</sub> ) 1400 F (LD <sub>50</sub> )	Bowman et al. 1978
7	Mouse (CD-1)	14 d 1 x/d (GO)				250 M (5/8 died)	Gulati et al. 1988
8	Mouse (Swiss)	once (GO)				1100 (LD <sub>50</sub> )	Jones et al. 1958
9	Mouse (B6C3F1)	4 d 1 x/d (GO)				277 M (Unscheduled deaths; 5/12 mice)	Larson et al. 1994d

Table 2-2. Levels of Significant Exposure to Chloroform - Oral (continued)

Key to <sup>a</sup> figure	Species/ (strain)	Exposure/ duration/ frequency (Specific route)	System	NOAEL (mg/kg/day)	LOAEL		Reference
					Less Serious (mg/kg/day)	Serious (mg/kg/day)	
10	Rabbit (Dutch Belted)	13 d Gd 6-18 2 x/d (GO)				100 F (3/5 died)	Thompson et al. 1974
		<b>Systemic</b>					
11	Human	once (IN)	Resp  Cardio Gastro Musc/skel Hepatic Renal		2410 M (respiratory tract obstruction)  2410 M (vomiting) 2410 M (muscle relaxation)	2410 M (arrhythmia)  2410 M (jaundice and toxic hepatitis) 2410 M (oliguria)	Schroeder 1965
12	Rat (Sprague- Dawley)	once (GO)	Hemato  Renal		546 (reduced hemoglobin and hematocrit by 10-12%)  546 F (increased kidney weight)		Chu et al. 1982b
13	Rat (Fischer- 344)	once (GO)	Hepatic  Renal  Bd Wt	477 M	34 M (elevated SDH, ALT and AST; scattered necrotic foci)	34 M (renal proximal tubule necrosis)	Larson et al. 1993
14	Rat (Fischer- 344)	4 d 1 x/d (GO)	Hepatic  Renal  Bd Wt	10 M  10 M 90 M	34 M (slight to mild centrilobular sinusoidal leukostasis) 34 M (degeneration of renal proximal tubules) 180 M (decreased body weight gain)		Larson et al. 1995a

Table 2-2. Levels of Significant Exposure to Chloroform - Oral (continued)

Key to <sup>a</sup> figure	Species/ (strain)	Exposure/ duration/ frequency (Specific route)	System	NOAEL (mg/kg/day)	LOAEL		Reference
					Less Serious (mg/kg/day)	Serious (mg/kg/day)	
15	Rat (Fischer- 344)	4 d 1 x/d (W)	Hepatic	33.2 M	68.1 M (mild hepatocyte vacuolation)		Larson et al. 1995a
			Renal Bd Wt	57.5 M			
16	Rat (Fischer- 344)	4 d (GO)	Resp		34 F (new bone formation; periosteal hypercellularity; degeneration of the olfactory epithelium and superficial Bowman's glands)		Larson et al. 1995b
			Hepatic	34 F			
			Renal	100 F	200 F (distal nephrons with hyaline casts; proximal tubules lined with degenerated, necrotic or regenerating epithelium)		
			Bd Wt	34 F	400 F (weight loss approximately 14%)		
17	Rat (Sprague- Dawley)	10 d Gd 6-15 1 x/d (GO)	Hemato		100 F (decreased hemoglobin and hematocrit)		Ruddick et al. 1983
			Hepatic		100 F (increased liver weight)		
			Renal Bd Wt	200 F	400 F (increased kidney weight)	100 F (32% decreased body weight gain)	

Table 2-2. Levels of Significant Exposure to Chloroform - Oral (continued)

Key to figure <sup>a</sup>	Species/ (strain)	Exposure/ duration/ frequency (Specific route)	System	LOAEL			Reference
				NOAEL (mg/kg/day)	Less Serious (mg/kg/day)	Serious (mg/kg/day)	
18	Rat (Sprague- Dawley)	10 d Gd 6-15 1-2 x/d (GO)	Gastro			516 F (gastric erosions)	Thompson et al. 1974
			Hepatic			516 F (acute toxic hepatitis)	
			Renal			516 F (acute toxic nephrosis)	
			Bd Wt	79 F	126 F (decreased body weight gain)		
19	Rat (Sprague- Dawley)	10 d Gd 6-15 2 x/d (GO)	Dermal	50 F	126 F (alopecia)		Thompson et al. 1974
			Bd Wt	20 F	50 F (decreased maternal body weight gain)		
20	Rat (Wistar)	once (GO)	Hepatic		100 M (increased plasma GOT and GPT)		Wang et al. 1994
21	Rat (Wistar)	once (GO)	Hepatic		100 (increased plasma GOT & GPT activity)		Wang et al. 1995
22	Mouse (CD-1)	14 d 1x/d (GO)	Dermal	50	100 (rough hair coat)		Gulati et al. 1988
			Bd Wt	100 M	250 M (12% weight loss)	500 M (32% weight loss)	
23	Mouse (Swiss- Webster)	once (GO)	Hepatic		35 (midzonal fatty changes)	350 (centrilobular necrosis)	Jones et al. 1958
24	Mouse (B6C3F1)	once (GO)	Hepatic	34 F	238 F (small randomly scattered foci of hepatocyte necrosis)		Larson et al. 1993
25	Mouse (B6C3F1)	4 d 1 x/d (GO)	Hepatic	90 F	238 F (centrilobular vacuolar degeneration; increased hepatic cell proliferation)		Larson et al. 1994b

Table 2-2. Levels of Significant Exposure to Chloroform - Oral (continued)

Key to <sup>a</sup> figure	Species/ (strain)	Exposure/ duration/ frequency (Specific route)	System	NOAEL (mg/kg/day)	LOAEL		Reference
					Less Serious (mg/kg/day)	Serious (mg/kg/day)	
26	Mouse (B6C3F1)	4 d (W)	Hepatic	26 <sup>b</sup> F	53 F (pale pink tinctorial changes in centrilobular hepatocytes)		Larson et al. 1994b
			Bd Wt		81 F (approximately 20% decreased body weight)		
27	Mouse (B6C3F1)	4 d 1 x/d (GO)	Hepatic	277 M	34 M (pale livers; mild centrilobular hepatocyte swelling; pale eosinophilic staining; periportal hepatocyte vacuolation)	138 M (centrilobular hepatocyte degeneration; scattered necrosis)	Larson et al. 1994d
			Renal			34 M (extensive acute necrosis, proximal convoluted tubule)	
			Bd Wt				
28	Mouse (CFLP- Swiss)	once (G)	Hepatic	59.2 M	199 M (increased SGPT)		Moore et al. 1982
			Renal		59.2 M	199 M (tubular necrosis; increased thymidine uptake)	
29	Mouse (CFLP Swiss)	once (GO)	Hepatic	65.6 M	273 M (increased thymidine uptake, increased SGOT)		Moore et al. 1982
			Renal		17.3 M	65.6 M (tubular necrosis)	
30	Mouse (CD-1)	14 d 1 x/d (GO)	Hemato	250			Munson et al. 1982
			Hepatic		125	250 (increased SGPT and SGOT levels)	
			Bd Wt		125 M	250 M (16% decreased body weight)	

Table 2-2. Levels of Significant Exposure to Chloroform - Oral (continued)

Key to <sup>a</sup> figure	Species/ (strain)	Exposure/ duration/ frequency (Specific route)	System	NOAEL (mg/kg/day)	LOAEL		Reference
					Less Serious (mg/kg/day)	Serious (mg/kg/day)	
31	Mouse (B6C3F1)	5 or 12 d 5 d/wk 1 x/d (GO)	Hepatic			263 F (necrotic, hydrotropic, swollen, and rounded hepatocytes; macrophage and neutrophil infiltration)	Pereira 1994
			Bd Wt	263 F			
32	Mouse (B6C3F1)	5 d 24 hr/d (W)	Hepatic		67.1 F (29% decreased relative liver weight; smaller hepatocytes with dense nonvacuolated and basophilic cytoplasm)		Pereira 1994
			Bd Wt	67.1 F			
			Other		67.1 F (decreased water consumption)		
33	Mouse (B6C3F1)	12 d 24 hr/d (W)	Hepatic		625.4 F (vacuolated hepatocytes)		Pereira 1994
			Bd Wt	625.4 F			
34	Rabbit (Dutch Belted)	13 d Gd 6-18 1 x/d (GO)	Gastro		20 F (diarrhea)		Thompson et al. 1974
			Bd Wt	35 F	50 F (decreased maternal body weight gain)		
<b>Immunological/Lymphoreticular</b>							
35	Rat (Sprague- Dawley)	once (GO)		765 F	1071 F (reduced lymphocytes)		Chu et al. 1982b
36	Mouse (CD-1)	14 d 1 x/d (GO)			50 (suppressed humoral immunity)		Munson et al. 1982
<b>Neurological</b>							
37	Human	once (IN)				2410 M (deep coma)	Schroeder 1965

Table 2-2. Levels of Significant Exposure to Chloroform - Oral (continued)

Key to figure	Species/ (strain)	Exposure/ duration/ frequency (Specific route)	System	NOAEL (mg/kg/day)	LOAEL		Reference
					Less Serious (mg/kg/day)	Serious (mg/kg/day)	
38	Mouse (ICR)	14 d 1 x/d (GO)		31.1 M			Balster and Borzelleca 1982
39	Mouse (ICR)	once (GO)			484 M (calculated ED <sub>50</sub> for motor performance)		Balster and Borzelleca 1982
40	Mouse (ICR Swiss)	once (GO)				500 (ataxia, incoordination, and anesthesia; brain hemorrhage)	Bowman et al. 1978
41	Mouse (CD-1)	14 d 1 x/d (GO)		100 M	250 M (hunched posture, inactivity)		Gulati et al. 1988
42	Mouse (Swiss)	once (GO)				350 (calculated ED <sub>50</sub> for narcosis)	Jones et al. 1958
43	Mouse (CD-1)	10 d 1 x/d (GO)		10 M	30 M (taste aversion)		Landauer et al. 1982
<b>Reproductive</b>							
44	Rat (Sprague-Dawley)	10 d Gd 6-15 1-2 x/d (GO)		300 F		316 F (increased resorptions)	Thompson et al. 1974
45	Rabbit (Dutch Belted)	13 d Gd 6-18 2 x/d (GO)		25 F		63 F (abortion; no viable concepti)	Thompson et al. 1974
<b>Developmental</b>							
46	Rat (Sprague-Dawley)	10 d Gd 6-15 1 x/d (GO)		200	400 (19% decreased fetal weight)		Ruddick et al. 1983



Table 2-2. Levels of Significant Exposure to Chloroform - Oral (continued)

Key to figure	Species/ (strain)	Exposure/ duration/ frequency (Specific route)	System	NOAEL (mg/kg/day)	LOAEL		Reference
					Less Serious (mg/kg/day)	Serious (mg/kg/day)	
47	Rat (Sprague-Dawley)	10 d Gd 6-15 1-2 x/d (GO)		300	316	(decreased fetal weight)	Thompson et al. 1974
48	Rat (Sprague-Dawley)	10 d Gd 6-15 2 x/d (GO)		50	126	(decreased fetal weight)	Thompson et al. 1974
49	Rabbit (Dutch Belted)	13 d Gd 6-18 2 x/d (GO)		100			Thompson et al. 1974

Table 2-2. Levels of Significant Exposure to Chloroform - Oral (continued)

Key to <sup>a</sup> figure	Species/ (strain)	Exposure/ duration/ frequency (Specific route)	System	NOAEL (mg/kg/day)	LOAEL		Reference	
					Less Serious (mg/kg/day)	Serious (mg/kg/day)		
<b>INTERMEDIATE EXPOSURE</b>								
<b>Death</b>								
50	Rat (Sprague-Dawley)	90 d (W)				142.2	(high mortality during exposure and during recovery period)	Chu et al. 1982a
51	Mouse (Schofield)	6 wk 6 d/wk (G)				150 M	(8/10 died)	Roe et al. 1979
<b>Systemic</b>								
52	Rat (Sprague-Dawley)	90 d (W)	Hemato	149.8				Chu et al. 1982a
			Bd Wt	44.9	142.2		(25% decreased body weight gain)	
53	Rat (Sprague-Dawley)	28 d (W)	Hemato	22.8 M	193 M		(decreased neutrophils)	Chu et al. 1982b
			Hepatic	193 M				
			Renal	193 M				
54	Rat (Osborne-Mendel)	90 d (W)	Resp	160 M				Jorgenson and Rushbrook 1980
			Gastro	160 M				
			Hemato	160 M				
			Hepatic	160 M				
			Renal	160 M				
			Bd Wt	81 M	160 M		(11-17% decreased body weight)	

Table 2-2. Levels of Significant Exposure to Chloroform - Oral (continued)

Key to <sup>a</sup> figure	Species/ (strain)	Exposure/ duration/ frequency (Specific route)	System	NOAEL (mg/kg/day)	LOAEL		Reference
					Less Serious (mg/kg/day)	Serious (mg/kg/day)	
55	Rat (Fischer- 344)	3 wk 5 d/wk 1 x/d (GO)	Hepatic	90 M	180 M	(degeneration of centrilobular hepatocytes)	Larson et al. 1995a
			Renal	90 M	180 M	(progressive degeneration of the proximal tubules)	
			Bd Wt	180 M			
56	Rat (Fischer- 344)	3 wk 7 d/wk 1 x/d (W)	Hepatic	62.3 M	106 M	(mild hepatocyte vacuolation)	Larson et al. 1995a
			Renal	6.0 M	17.4 M	(increased numbers of focal areas of regenerating renal proximal tubular epithelium and cell proliferation)	
			Bd Wt	62.3 M	106 M	(25% decrease in weight gain - taken from graph)	
57	Rat (Fischer- 344)	3 wk 5 d/wk (GO)	Resp		34 F	(new bone formation; periosteal hypercellularity)	Larson et al. 1995b
			Hepatic	100 F	400 F	(diffuse vacuolar change; focal centrilobular degeneration)	
			Renal	34 F	100 F	(proximal tubule epithelial regeneration, dilation and mineralized concretions)	
			Bd Wt		100 F	(significant decrease in weight gain)	

Table 2-2. Levels of Significant Exposure to Chloroform - Oral (continued)

Key to figure	Species/ (strain)	Exposure/ duration/ frequency (Specific route)	System	NOAEL (mg/kg/day)	LOAEL		Reference		
					Less Serious (mg/kg/day)	Serious (mg/kg/day)			
58	Rat (Sprague- Dawley)	13 wk 7 d/wk 1 x/d (G)	Hemato	150	410	(increased cellular proliferation in bone marrow)	Palmer et al. 1979		
			Hepatic	30	150	(increased relative liver weight)		410	(fatty changes, necrosis)
			Renal	30	150	(increased relative kidney weight)			
59	Mouse (B6C3F1)	90 d 1 x/d (GO)	Hepatic		60	(fatty changes)	270	(cirrhosis)	Bull et al. 1986
			Bd Wt	130 M	270 M	(15% decreased body weight)			
60	Mouse (Strain A)	30 d 1 x/d (GO)	Hepatic	297			594	(cirrhosis)	Eschenbrenner and Miller 1945a
61	Mouse (CD-1)	105 d 1 x/d (GO)	Resp	41					Gulati et al. 1988
			Hepatic	16 F	41 F	(increased liver weight and hepatocellular degeneration)			
			Renal	41					
62	Mouse (B6C3F1)	90 d (W)	Resp	435 F					Jorgenson and Rushbrook 1980
			Gastro	435 F					
			Hemato	435 F					
			Hepatic	32 F	64 F	(fatty changes)			
			Renal	435 F					

Table 2-2. Levels of Significant Exposure to Chloroform - Oral (continued)

Key to <sup>a</sup> figure	Species/ (strain)	Exposure/ duration/ frequency (Specific route)	System	NOAEL (mg/kg/day)	LOAEL		Reference
					Less Serious (mg/kg/day)	Serious (mg/kg/day)	
63	Mouse (B6C3F1)	52 wk 7 d/wk (W)	Resp	257 M			Klaunig et al. 1986
			Hepatic		86 M (focal necrosis)		
			Renal			86 M (tubular necrosis)	
			Bd Wt		86 M (15% decreased body weight gain)		
64	Mouse (B6C3F1)	3 wk 5 d/wk 1 x/d (GO)	Hepatic		34 F (vacuolation of the centrilobular and midzonal hepatocytes; increased ALT and SDH)		Larson et al. 1994b
			Renal	477 F			
65	Mouse (B6C3F1)	3 wk 7 d/wk (W)	Hepatic		82 F (increased liver weight)		Larson et al. 1994b
			Renal	329 F			
66	Mouse (B6C3F1)	3 wk 5 d/wk 1 x/d (GO)	Hepatic	34 M	90 M (centrilobular hepatocyte swelling; loss of eosinophilia)	138 M (centrilobular and periportal hepatocyte degeneration and necrosis)	Larson et al. 1994d
			Renal		34 M (regenerating proximal convoluted tubules)	277 M (degeneration & necrosis of the proximal tubules)	
			Bd Wt	138 M	277 M (15-20% decrease in body weight)		
67	Mouse (CD-1)	90 d 1 x/d (GO)	Hepatic		50 (hydropic degeneration)		Munson et al. 1982
			Renal		50 (chronic inflammation of lymphocytes)		
			Bd Wt	250			

Table 2-2. Levels of Significant Exposure to Chloroform - Oral (continued)

Key to <sup>a</sup> figure	Species/ (strain)	Exposure/ duration/ frequency (Specific route)	System	NOAEL (mg/kg/day)	LOAEL		Reference
					Less Serious (mg/kg/day)	Serious (mg/kg/day)	
68	Mouse (B6C3F1)	33 or 159 d 5 d/wk 1 x/d (GO)	Hepatic		263 F	(30.1-38.2% increase in relative liver weight; focal areas of necrotic, swollen, rounded, and pale hepatocytes and a low number of mononuclear cells)	Pereira 1994
			Bd Wt	263 F			
69	Mouse (B6C3F1)	33 d 24 hr/d (W)	Hepatic	438.5 F			Pereira 1994
			Bd Wt	438.5 F			
70	Mouse (B6C3F1)	159 d 24 hr/d (W)	Hepatic		363.5 F	(31.4% increase in relative liver weight)	Pereira 1994
			Bd Wt	386 F			
71	Dog (Beagle)	6 wk 6 d/wk 1 x/d (C)	Hepatic	15 <sup>c</sup>	30	(significantly increased SGPT activity)	Heywood et al. 1979
<b>Immunological/Lymphoreticular</b>							
72	Mouse (CD-1)	90 d 1 x/d (GO)			50	(depressed humoral immunity)	Munson et al. 1982
<b>Neurological</b>							
73	Mouse (ICR)	90 d 1x/d (GO)		31.1 M			Balster and Borzelleca 1982
74	Mouse (ICR)	60 d 1x/d (GO)			100 M	(operant behavior affected)	Balster and Borzelleca 1982

Table 2-2. Levels of Significant Exposure to Chloroform - Oral (continued)

Key to <sup>a</sup> figure	Species/ (strain)	Exposure/ duration/ frequency (Specific route)	System	NOAEL (mg/kg/day)	LOAEL		Reference
					Less Serious (mg/kg/day)	Serious (mg/kg/day)	
<b>Reproductive</b>							
75	Rat (Osborne- Mendel)	90 d (W)		160 M			Jorgenson and Rushbrook 1980
76	Rat (Sprague- Dawley)	13 wk 7 d/wk 1 x/d (G)		150		410 (gonadal atrophy)	Palmer et al. 1979
77	Mouse (CD-1)	105 d 1 x/d (GO)		41			Gulati et al. 1988
<b>Developmental</b>							
78	Mouse (ICR)	6-10 wk 1 x/d (GO)		31.1			Burkhalter and Balster 1979
79	Mouse (CD-1)	105 d 1 x/d (GO)			41 M (increased epididymal weights, degeneration of epididymal epithelium in F <sub>1</sub> )		Gulati et al. 1988
80	Mouse (CD-1)	105 d 1 x/d (GO)			41 F (increased liver weight and hepatocellular degeneration in F <sub>1</sub> females)		Gulati et al. 1988
<b>Cancer</b>							
81	Mouse (Strain A)	30 d 1 x/d (GO)				594 (CEL: hepatomas)	Eschenbrenner and Miller 1945a

Table 2-2. Levels of Significant Exposure to Chloroform - Oral (continued)

Key to <sup>a</sup> figure	Species/ (strain)	Exposure/ duration/ frequency (Specific route)	System	NOAEL (mg/kg/day)	LOAEL		Reference
					Less Serious (mg/kg/day)	Serious (mg/kg/day)	
<b>CHRONIC EXPOSURE</b>							
<b>Death</b>							
82	Rat (Osborne- Mendel)	78 wk 5 d/wk 1 x/d (GO)				90 M (decreased survival)  100 F	NCI 1976
83	Mouse (B6C3F1)	78 wk 5 d/wk 1 x/d (GO)				477 F (decreased survival)	NCI 1976
<b>Systemic</b>							
84	Human	1-5 yr	Hepatic	0.96			De Salva et al. 1975
			Renal	0.96			
85	Human	10 yr 1 x/d (IN)	Hemato Hepatic		21 M (decreased erythrocytes)	21 M (increased sulfobromophthalein sodium retention)	Wallace 1950
			Renal			21 M (albuminuria)	
86	Rat (Osborne- Mendel)	104 wk 7 d/wk (W)	Renal	160 M			Jorgenson et al. 1985
			Bd Wt	38 M	81 M (decreased body weight)		



Table 2-2. Levels of Significant Exposure to Chloroform - Oral (continued)

Key to figure	Species/ (strain)	Exposure/ duration/ frequency (Specific route)	System	NOAEL (mg/kg/day)	LOAEL		Reference
					Less Serious (mg/kg/day)	Serious (mg/kg/day)	
87	Rat (Osborne-Mendel)	78 wk 5 d/wk 1 x/d (GO)	Resp	200 F			NCI 1976
			Cardio	200 F			
			Gastro	200 F			
			Hemato	200 F			
			Musc/skel	200 F			
			Hepatic	100 F	200 F (necrosis of hepatic parenchyma)		
				180 M			
	Renal	200 F					
	Bd Wt		90 M (15% decreased weight gain)				
88	Rat (Wistar)	180 wk 7 d/wk (W)	Hepatic			200 (adenofibrosis)	Tumasonis et al. 1985, 1987
			Bd Wt			200 M (50% decreased body weight gain)	
89	Mouse (B6C3F1)	104 wk 7 d/wk (W)	Bd Wt	130 F	263 F (decreased body weight)		Jorgenson et al. 1985
90	Mouse (B6C3F1)	78 wk 5 d/wk 1 x/d (GO)	Resp		238 F (pulmonary inflammation)		NCI 1976
			Cardio		238 F (cardiac thrombosis)		
			Gastro	477 F			
			Hemato	477 F			
			Musc/skel	477 F			
			Hepatic		138 M (nodular hyperplasia of the liver)		
					238 F		
	Renal	477 F					
	Bd Wt	477 F					

Table 2-2. Levels of Significant Exposure to Chloroform - Oral (continued)

Key to <sup>a</sup> figure	Species/ (strain)	Exposure/ duration/ frequency (Specific route)	System	NOAEL (mg/kg/day)	LOAEL		Reference
					Less Serious (mg/kg/day)	Serious (mg/kg/day)	
91	Mouse (IC1)	80 wk 6 d/wk (G)	Resp	60			Roe et al. 1979
			Hepatic		17	(fatty degeneration)	
			Renal	60			
			Bd Wt	60			
92	Dog (Beagle)	7.5 yr 6 d/wk (C)	Cardio	30			Heywood et al. 1979
			Hemato	30			
			Hepatic		15 <sup>d</sup>	(increased SGPT activity)	
			Renal	15	30	(fatty changes)	
			Bd Wt	30			
<b>Neurological</b>							
93	Rat (Osborne- Mendel)	78 wk 5 d/wk 1 x/d (GO)		200 F			NCI 1976
94	Mouse (B6C3F1)	78 wk 5 d/wk 1 x/d (GO)		477 F			NCI 1976
95	Mouse (IC1)	80 wk 6 d/wk (G)		60			Roe et al. 1979
<b>Reproductive</b>							
96	Rat (Osborne- Mendel)	78 wk 5 d/wk 1 x/d (GO)		200 F			NCI 1976
				180 M			

Table 2-2. Levels of Significant Exposure to Chloroform - Oral (continued)

Key to figure <sup>a</sup>	Species/ (strain)	Exposure/ duration/ frequency (Specific route)	System	NOAEL (mg/kg/day)	LOAEL		Reference
					Less Serious (mg/kg/day)	Serious (mg/kg/day)	
97	Mouse (B6C3F1)	78 wk		477 F			NCI 1976
		5 d/wk 1 x/d (GO)		277 M			
98	Dog (Beagle)	7.5 yr 6 d/wk (C)		30			Heywood et al. 1979
<b>Cancer</b>							
99	Rat (Osborne- Mendel)	104 wk 7 d/wk (W)				160 M (CEL: tubular cell adenoma)	Jorgenson et al. 1985
100	Rat (Osborne- Mendel)	78 wk 5 d/wk 1 x/d (GO)				90 M (CEL: tubular cell adenoma and carcinoma; tubular cell neoplasms in 4/50)	NCI 1976; Dunnick and Melnick 1993
						200 F (CEL: kidney tubular cell neoplasms in 2/48)	
101	Rat (Wistar)	180 wk 7 d/wk (W)				200 F (CEL: hepatic neoplastic nodules)	Tumasonis et al. 1985, 1987
102	Mouse (B6C3F1)	78 wk 5 d/wk 1 x/d (GO)				138 M (CEL: hepatocellular adenomas or carcinomas in 18/50 mice)	NCI 1976; Dunnick and Melnick 1993
						238 F (CEL: hepatocellular adenomas or carcinomas in 36/45 mice)	

Table 2-2. Levels of Significant Exposure to Chloroform - Oral (continued)

Key to <sup>a</sup> figure	Species/ (strain)	Exposure/ duration/ frequency (Specific route)	System	NOAEL (mg/kg/day)	LOAEL		Reference
					Less Serious (mg/kg/day)	Serious (mg/kg/day)	
103	Mouse (ICI)	80 wk 6 d/wk (G)				60 M (CEL: epithelial tumors of the kidney)	Roe et al. 1979

<sup>a</sup>The number corresponds to entries in Figure 2-2.

<sup>b</sup>Used to derive an acute oral minimal risk level (MRL) of 0.3 mg/kg/day; dose divided by an uncertainty factor of 100 (10 for extrapolation from animals to humans, and 10 for human variability).

<sup>c</sup>Used to derive an intermediate oral MRL of 0.1 mg/kg/day; dose adjusted for intermittent exposure and divided by an uncertainty factor of 100 (10 for extrapolation from animals to humans, and 10 for human variability).

<sup>d</sup>Used to derive a chronic oral MRL of 0.01 mg/kg/day; dose adjusted for intermittent exposure and divided by an uncertainty factor of 1000 (10 for use of a LOAEL, 10 for extrapolation from animals to humans, and 10 for human variability).

ALT = alanine amino transferase; ST = aspartate amino transferase; Bd Wt = body weight; (C) = capsule; Cardio = cardiovascular; CEL = cancer effect level; d = day(s); ED<sub>50</sub> = effective dose for a given effect in 50% of animals; F = female; F<sub>1</sub> = first filial generation; (G) = gavage; Gastro = gastrointestinal; Gd = gestational day; (GO) = gavage in oil; GOT = glutamic oxaloacetic transaminase; GPT = glutamic pyruvic transaminase; Hemato = hematological; hr = hour(s); (IN) = ingestion; LD<sub>50</sub> = lethal dose, 50% kill; LOAEL = lowest-observed-adverse-effect level; M = male; Musc/skel = musculoskeletal; NOAEL = no-observed-adverse-effect level; NS = not specified; Resp = respiratory; SDH = sorbitol dehydrogenase; SGOT = serum glutamic oxaloacetic transaminase; SGPT = serum glutamic pyruvic transaminase; (W) = drinking water; wk = week; x = time(s); yr = year(s)

Figure 2-2. Levels of Significant Exposure to Chloroform - Oral

Acute ( $\leq 14$  days)

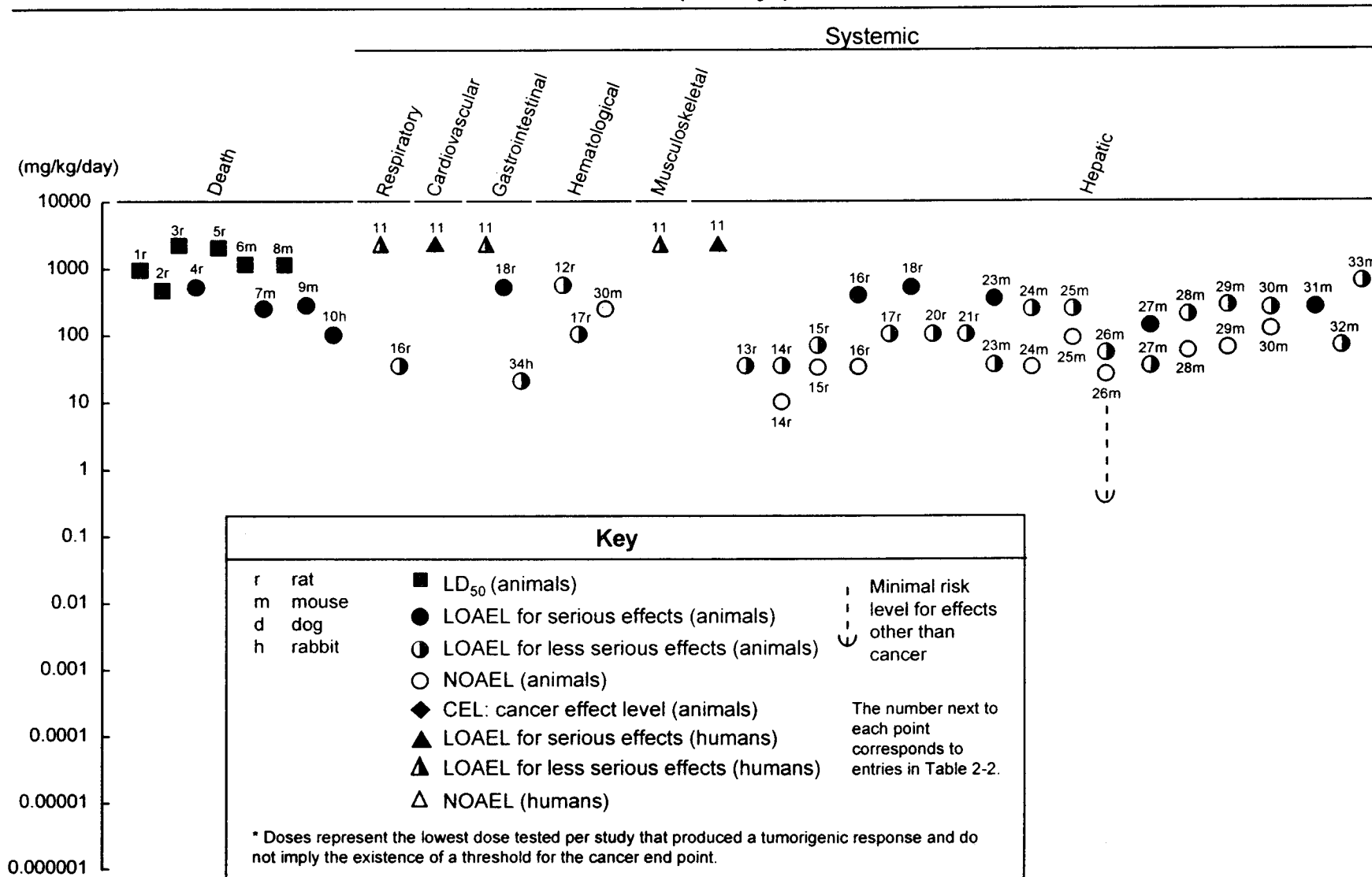
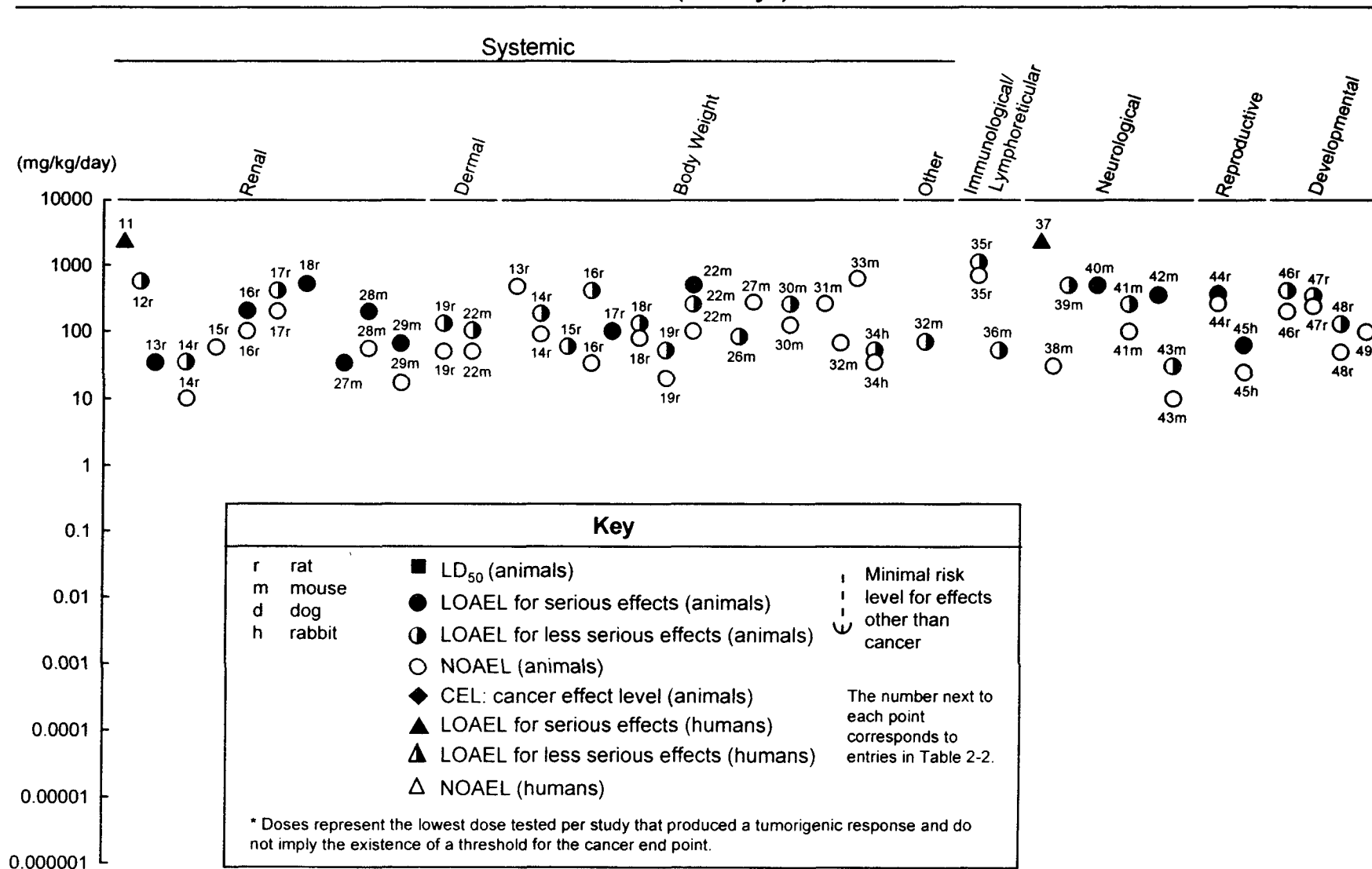
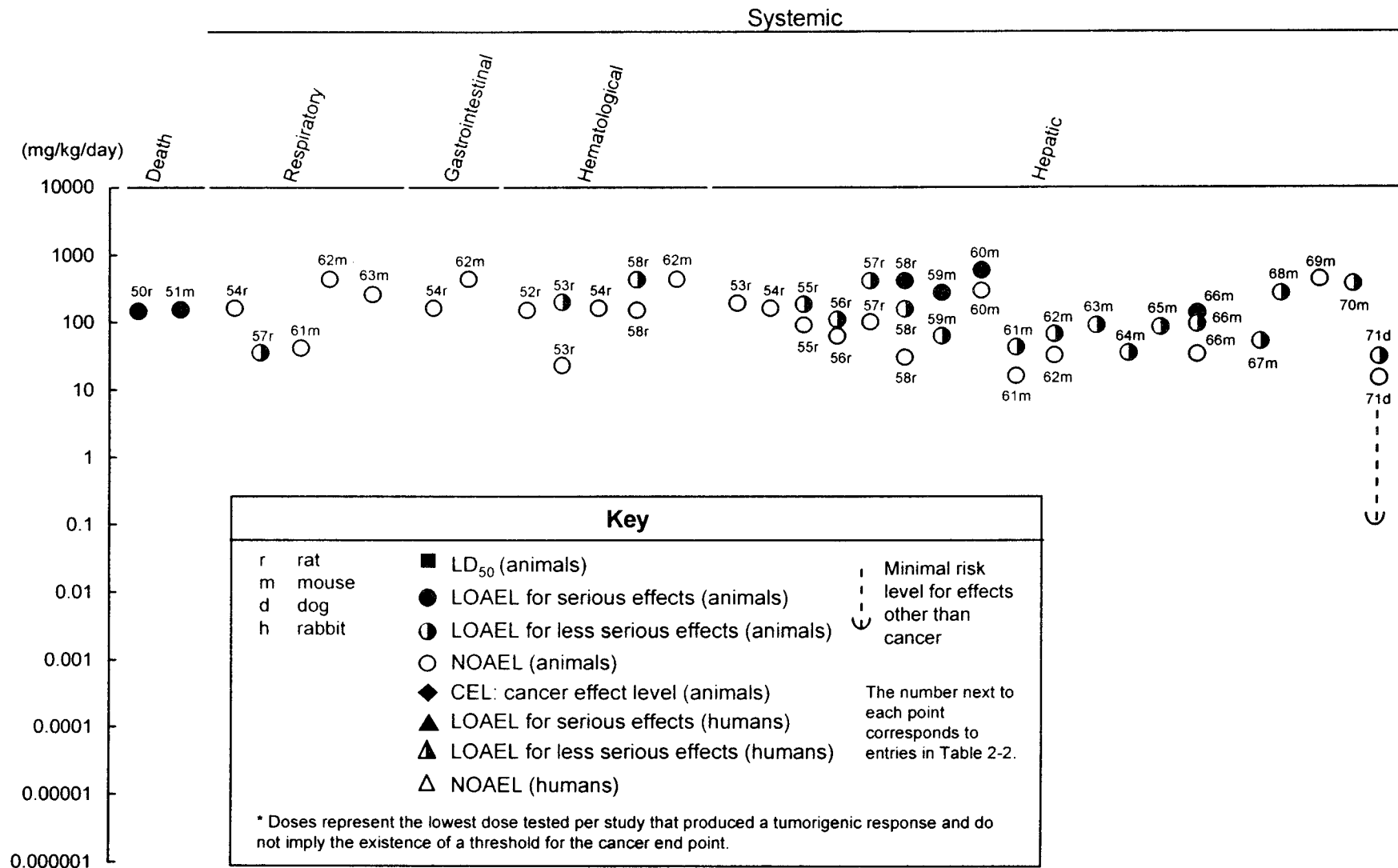


Figure 2-2. Levels of Significant Exposure to Chloroform - Oral (cont.)

Acute ( $\leq 14$  days)

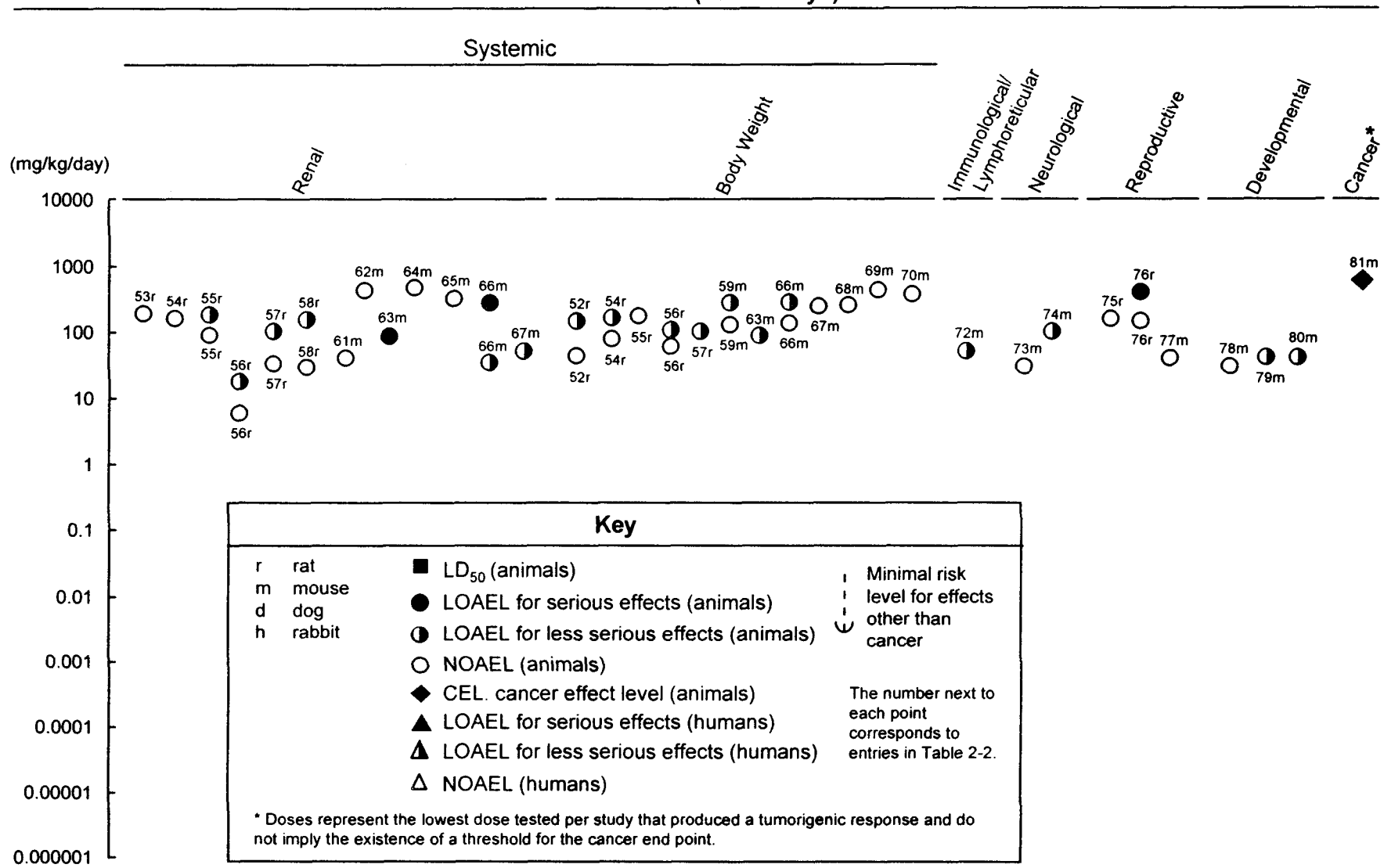


**Figure 2-2. Levels of Significant Exposure to Chloroform - Oral (cont.)**  
**Intermediate (15-364 days)**



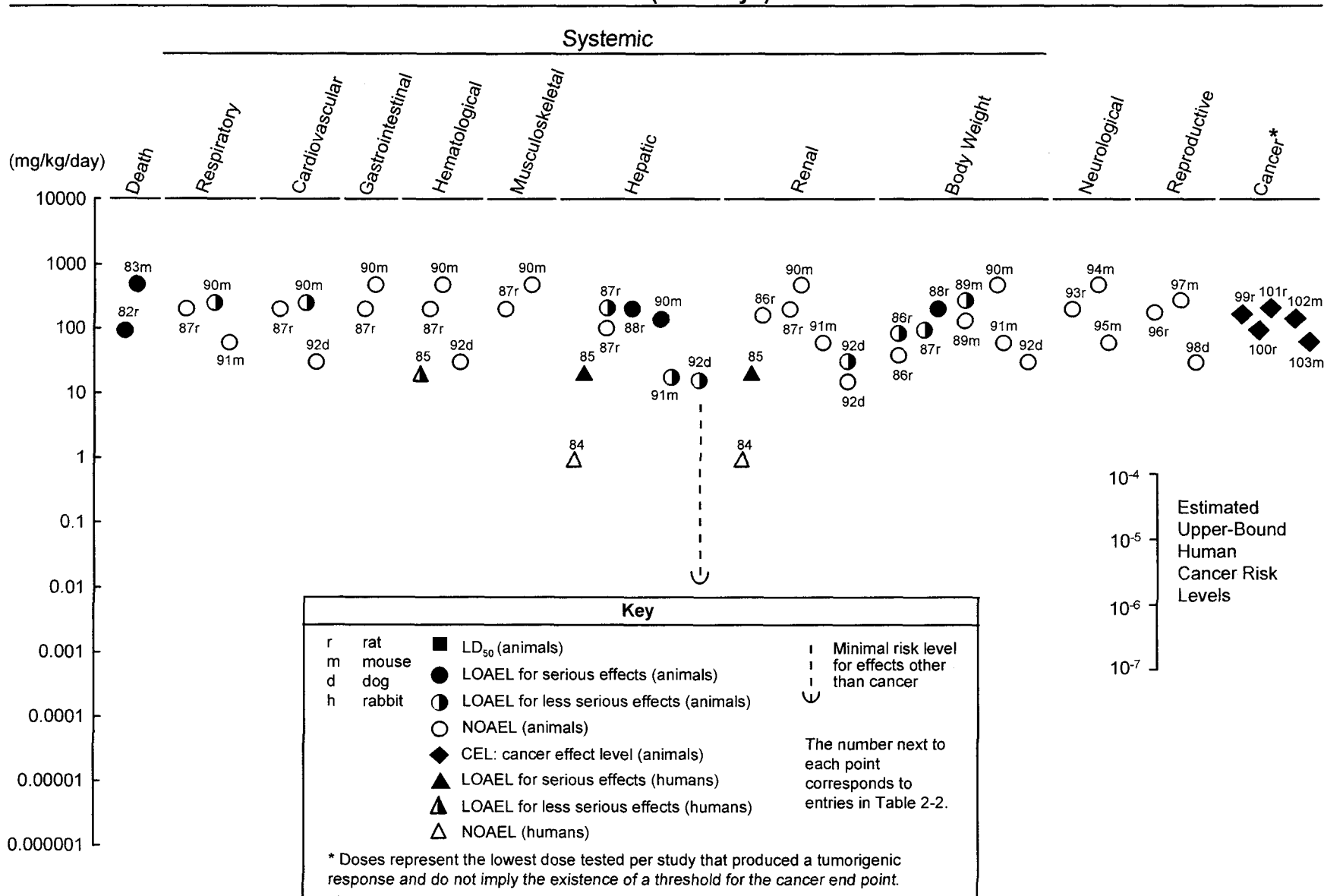
2. HEALTH EFFECTS

**Figure 2-2. Levels of Significant Exposure to Chloroform - Oral (cont.)**  
**Intermediate (15-364 days)**





**Figure 2-2. Levels of Significant Exposure to Chloroform - Oral (cont.)  
Chronic (≥365 days)**



## 2. HEALTH EFFECTS

**Respiratory Effects.** Information regarding respiratory effects in humans after oral exposure to chloroform is limited. Upper respiratory tract obstruction due to muscular relaxation was observed in a patient who accidentally ingested  $\approx 2,410$  mg/kg chloroform (Schroeder 1965). Congested lungs and scattered patches of pneumonic consolidation were found at autopsy in a man who committed suicide by drinking  $\approx 6$  ounces (3,755 mg/kg) of chloroform (Piersol et al. 1933). In both of these case studies, very large doses of chloroform were consumed. Thus, the respiratory effects noted may not be characteristic of those seen after ingestion of more moderate doses.

The majority of animal data suggest that the respiratory system is not a target of chloroform-induced toxicity after oral exposure. However, in one study, female Fisher 344 rats administered chloroform by gavage in corn oil at doses of 34, 100, 200, or 400 mg/kg/day for 4 days or 3 weeks did exhibit dose-dependent nasal lesions consisting of early phases of new bone formation, periosteal hypercellularity, and degeneration of the olfactory epithelium and superficial Bowman's glands (Larson et al. 1995b). In other studies, no treatment-related histopathological changes were found in the lungs of rats exposed to 160 mg/kg/day or mice exposed to 435 mg/kg/day chloroform in drinking water in a 90-day study (Jorgenson and Rushbrook 1980), in mice exposed by gavage to 41 mg/kg/day chloroform in oil for 105 days (Gulati et al. 1988), or in mice exposed to 257 mg/kg/day in drinking water for 1 year (Klaunig et al. 1986).

Following chronic exposure, no histopathological changes were observed in rats exposed by gavage to 200 mg/kg/day TWA chloroform in oil (NCI 1976). Respiratory disease was observed in all chloroform-exposed groups of rats ( $\geq 15$  mg/kg/day); however, no histopathological changes were observed in a 60 mg/kg/day exposure group during another experiment by the same investigators (Palmer et al. 1979). No histopathological changes were observed in the lungs of male mice exposed by gavage to 277 mg/kg/day TWA chloroform in oil for 78 weeks (NCI 1976) or to 60 mg/kg/day in toothpaste for 80 weeks (Roe et al. 1979).

**Cardiovascular Effects.** Information regarding cardiovascular effects after oral exposure to chloroform is limited to case report studies. On admission to the hospital, the blood pressure was 140/90 mm Hg and pulse was 70 beats per minute (bpm) in a patient who accidentally ingested  $\approx 2,410$  mg/kg chloroform (Schroeder 1965). Electrocardiography showed occasional extra systoles and a slight S-T segment depression. The patient recovered with no persistent cardiovascular change. In another individual, blood pressure was 100/40 mm Hg and pulse was 108 bpm after ingestion of an

## 2. HEALTH EFFECTS

unknown quantity of chloroform and alcohol (Storms 1973). In both of these case studies, other factors (e.g., age, consumption of alcohol, suicidal/agitated state) may have contributed to the cardiovascular effects seen. Thus, it would appear that no studies exist which reliably indicate the presence of cardiovascular effects after oral chloroform exposure in humans.

Information regarding cardiovascular effects in animals after oral exposure to chloroform is limited; the data suggest that, at the doses utilized, the cardiovascular system was not a target for chloroform toxicity. No histopathological changes were observed in rats and mice chronically exposed by gavage to 200 and 477 mg/kg/day TWA chloroform, respectively, for 78 weeks (NCI 1976). In this study, cardiac thrombosis was observed in low-dose female mice, but was not seen in high-dose female or male mice or either sex of rat at any dose. Similarly, no cardiovascular changes were observed in dogs exposed to 30 mg/kg/day chloroform in toothpaste capsules for 7.5 years (Heywood et al. 1979).

**Gastrointestinal Effects.** Retrosternal soreness, pain on swallowing, and gastric distress with vomiting were reported in cases of intentional and accidental ingestion of chloroform (Piersol et al. 1933; Schroeder 1965). At autopsy, congestion with patchy necrosis of the mucosa was observed in the stomach and duodenum of a man who died after drinking  $\approx 3,755$  mg/kg chloroform (Piersol et al. 1933). The colonic mucosa was edematous, and the rectosigmoid junction was hemorrhagic. A 16-year-old female who ingested an unknown amount of chloroform arrived at a hospital semiconscious and with repeated vomiting. She was treated with gastric lavage, antacids, intravenous glucose, and antiemetics. She had apparently recovered and was released. Seven days later, she presented with hepatomegaly, slightly depressed hemoglobin, and an abnormal liver sonogram, but no gastric side-effects (Hakim et al. 1992).

The effects of chronic oral exposure to chloroform, as a by-product of the chlorination of drinking water, were evaluated in four epidemiology studies (Alavanja et al. 1978; Cantor et al. 1978; Saurez-Varela et al. 1994; Young et al. 1981). The association between the incidence of gastrointestinal cancer in humans and the chlorination of drinking water is discussed in Section 2.2.2.8. The data from these studies should be viewed with caution as many other known or suspected carcinogens are known to exist in chlorinated drinking water.

Gastrointestinal irritation has been observed in some animals after oral exposure to chloroform. Gastric erosions were observed in pregnant rats gavaged with 516 mg/kg chloroform in oil during

## 2. HEALTH EFFECTS

gestation (Thompson et al. 1974). Rabbits exposed by gavage to 20 mg/kg/day chloroform in oil during gestation had diarrhea; no histological results were provided. In a 90-day drinking-water study, no histopathological changes were observed in rats and mice exposed to 160 and 435 mg/kg/day chloroform, respectively (Jorgenson and Rushbrook 1980). Vomiting was observed in dogs exposed to 30 mg/kg/day chloroform in toothpaste capsules for 12-18 weeks (Heywood et al. 1979). In a chronic exposure study, no histopathological changes in gastrointestinal tissue were observed in rats and mice exposed by gavage to 200 and 477 mg/kg/day TWA chloroform, respectively (NCI 1976).

**Hematological Effects.** The only information regarding hematological effects in humans after chronic oral exposure to chloroform was reported in a case study. Decreased erythrocytes and hemoglobin were observed in a subject who ingested  $\approx 21$  mg/kg/day chloroform in a cough medicine for 10 years (Wallace 1950). The lack of detail and the potential for confounding factors in this study does not allow a firm conclusion regarding the hematological effects of oral exposure to chloroform in humans.

Hematological effects have been observed in some animals after oral exposure to chloroform. Hemoglobin and hematocrit decreased in male and female rats after a single oral dose of 546 mg/kg chloroform in oil (Chu et al. 1982b) and in female rats exposed to 100 mg/kg/day chloroform during gestation (Ruddick et al. 1983). However, no hematological changes were observed in mice exposed to 250 mg/kg/day for 14 days (Munson et al. 1982). In an intermediate-duration study, decreased neutrophils were observed in rats exposed to 192.98 mg/kg/day in drinking water (Chu et al. 1982b); however, no hematological changes were observed in rats and mice exposed to 160 and 435 mg/kg/day chloroform, respectively, for 90 days in drinking water (Chu et al. 1982a; Jorgenson and Rushbrook 1980). Increased cellular proliferation in the bone marrow was observed in rats exposed by gavage for 13 weeks to 410 mg/kg chloroform in toothpaste (Palmer et al. 1979). No hematological changes were observed, however, in rats similarly exposed to 165 and 60 mg/kg/day chloroform by gavage for 52 and 80 weeks, respectively. Moreover, no histopathological changes in hematopoietic tissues were observed in rats and mice after chronic exposure to 200 and 477 mg/kg/day TWA chloroform in oil, respectively (NCI 1976). No hematological effects were observed in dogs exposed to 30 mg/kg/day chloroform in toothpaste in capsules for 7.5 years (Heywood et al. 1979). In conclusion, no consistent hematological effects were noted in human or animal studies of oral exposure to chloroform.

## 2. HEALTH EFFECTS

**Musculoskeletal Effects.** The only information regarding musculoskeletal effects in humans after oral exposure to chloroform was reported in a case study. Muscular relaxation of the jaw caused upper respiratory obstruction in a man who accidentally ingested approximately 2,410 mg/kg chloroform (Schroeder 1965), reflecting the neurological effects of chloroform exposure.

Only one report detailing musculoskeletal effects in animals after oral exposure to chloroform was located. In that study, no histopathological changes were observed in the musculoskeletal system of rats and mice after chronic gavage exposure to 200 and 477 mg/kg/day TWA chloroform in oil, respectively (NCI 1976).

**Hepatic Effects.** The liver is a primary target of chloroform toxicity in humans, with some evidence that suggests that the damage may be reversible (Wallace 1950). Hepatic injury occurred in patients within 1-3 days following chloroform ingestion (Piersol et al. 1933; Schroeder 1965; Storms 1973). Jaundice and liver enlargement and tenderness developed in all patients. The clinical observations were supported by blood biochemistry results with increased SGOT, SGPT, and lactate dehydrogenase (LDH) activities and increased bilirubin levels. At autopsy, fatty degeneration and extensive centrilobular necrosis were observed in one fatal case (Piersol et al. 1933).

A 16-year-old female who ingested an unknown amount of chloroform and arrived at a hospital semiconscious and with repeated vomiting was reported by Hakim et al. (1992). She was treated with gastric lavage, antacids, intravenous glucose, and antiemetics. She had apparently recovered and was released. Seven days later, she presented with hepatomegaly, slightly depressed hemoglobin, and an abnormal liver sonogram, suggesting toxic hepatic disease due to chloroform toxicosis. A 33-year-old female had injected herself intravenously with 0.5 mL of chloroform and then became unconscious. When she awoke approximately 12 hours later, she then drank another 120 mL of chloroform. She was treated with hyperbaric oxygen, cimetidine (to inhibit cytochrome P-450 and formation of phosgene), and N-acetylcysteine (to replenish GSH stores). Liver serum enzymes alkaline phosphatase (ALP), alanine aminotransferase (ALT), aspartate aminotransferase (AST), and LDH were elevated in a pattern that suggested liver cell necrosis. Generally, these enzymes were noted to peak by day 4 and decrease by day 11. Total bilirubin and direct bilirubin did not change appreciably. GGT (gamma glutamyltransferase, also known as gamma glutamyl transpeptidase), alpha-feto protein and retinol binding protein showed increases between 6 and 8 days after ingestion, but still within normal ranges for humans (Rao et al. 1993).

## 2. HEALTH EFFECTS

Increased sulfobromophthalein retention indicated impaired liver function in an individual who ingested 21 mg/kg/day chloroform in a cough medicine for 10 years (Wallace 1950). The changes reversed to normal after exposure was discontinued. Biochemical tests indicate that liver function in male and female humans was not affected by the use of mouthwash providing 0.96 mg/kg/day chloroform for  $\leq 5$  years (De Salva et al. 1975).

The liver is also a target organ for chloroform toxicity in animals. In acute studies, hepatitis was observed in pregnant rats exposed by gavage to 516 mg/kg/day chloroform in oil (Thompson et al. 1974), while increased maternal liver weight without any histopathological changes was observed in pregnant rats similarly exposed to 100 mg/kg/day chloroform (Ruddick et al. 1983). Increased serum levels of transaminases, indicative of liver necrosis, were observed in mice treated with a single gavage dose of 199 mg/kg chloroform in toothpaste, 273 mg/kg in oil (Moore et al. 1982), or 250 mg/kg/day in oil for 14 days (Munson et al. 1982). Similar results were reported for rats treated with a single gavage dose of 100 mg/kg (Wang et al. 1994, 1995) or 0.1 mL/kg (Nakajima et al. 1995). Centrilobular necrosis of the liver with massive fatty changes was also observed in mice after a single dose of 350 mg/kg chloroform in oil (Jones et al. 1958). At a dose of 35 mg/kg, minimal lesions consisting of mid-zonal fatty changes were observed in mice.

Similar results were reported by Larson et al. (1993) in male rats in order to identify target tissues for the acute effects of chloroform in rats and mice and to establish the time-course of chloroform-induced histopathologic and proliferative responses. Rats were given 34, 180, or 477 mg/kg once in corn oil by gavage and sacrificed 24 hours after administration (acute-duration study). In a related time-course study (which focused on histologic changes in tissues over time), rats received 180 mg/kg chloroform in corn oil by gavage and were sacrificed at 0.5, 1, 2, 4, and 8 days after treatment, or received 477 mg/kg in corn oil by gavage and were sacrificed either 1 or 2 days after administration. In the acute study, gross liver to body weight ratios were unaffected at all doses. Histologically, chloroform caused hepatic injury, in a dose-related manner, producing morphologic changes generally limited to the centrilobular hepatocytes. Liver enzymes (SDH, ALT, and AST) were slightly elevated above controls in the 34 and 180 mg/kg group, but were significantly higher in the 477 mg/kg group for all three enzymes. In the time-course study, 1 day after dosing, about 50% of the hepatocytes adjacent to the central veins were degenerated or necrotic in the 180 mg/kg treatment group. Larger vessels had perivascular edema, influx of neutrophils and eosinophils. Only scattered hepatocyte necrosis was seen

## 2. HEALTH EFFECTS

by day 2 after treatment. By eight days however, the livers were not histologically different from controls.

In a similar study, mice were administered 34, 238, or 477 mg/kg once in corn oil by gavage and sacrificed 24 hours after administration (acute study) or 350 mg/kg chloroform in corn oil by gavage and sacrificed at 0.5, 1, 2, 4, and 8 days after treatment (time-course study). Livers of female mice were much more sensitive than the kidneys to the toxic effects of chloroform. In the acute study, livers of mice receiving 34 mg/kg chloroform were not histologically different from controls; however, those treated with 238 mg/kg had few small randomly scattered foci of hepatocyte necrosis. Livers from the 477 mg/kg group had centrilobular coagulative necrosis of 50% of the lobule. In the timecourse study, a significant increase in liver weights and liver to body-weight ratios was observed in mice at 2 and 4 days after treatment with the 350 mg/kg dose of chloroform. At 12 hours after treatment, mice had marked swelling of the centrilobular hepatocytes, affecting about 50% of the lobule. One day after treatment, the hepatocytes adjacent to the central vein were necrotic. Two days after chloroform treatment, centrilobular sinusoids were dilated with inflammatory cells associated with centrilobular necrosis. At eight days after treatment, the livers from the treated mice were not histologically different from those of control animals. Serum liver enzymes (SDH and ALT) were elevated in the groups sacrificed at 0.5, 1, 2, and 4 days after treatment, but not in controls or in those animals sacrificed 8 days after treatment.

Another study by Larson et al. (1994d) identified the relationships among chloroform-induced cytolethality, regenerative cell proliferation, and tumor induction in male B6C3F<sub>1</sub> mice dosed with 0, 34, 90, 138, or 277 mg/kg/day chloroform by gavage in corn oil. Mice exposed to 90 mg/kg/day experienced prominent centrilobular hepatocyte swelling with loss of cytoplasmic eosinophilia. Mice exposed to 138 and 277 mg/kg/day experienced increasing levels of centrilobular hepatocyte swelling and degeneration, as well as scattered necrosis and inflammatory cell accumulation. Dose-dependent increases in hepatocyte proliferation were seen in all dose groups after exposure to chloroform for 4 days.

Differences in chloroform toxicity have been noted in female mice when chloroform was administered in different vehicles and by different dosing regimes (Larson et al. 1994b). Mice were treated orally with 3, 10, 34, 90, 238, or 477 mg/kg/day of chloroform in corn oil, or with 16, 26, 53, 81, or 105 mg/kg/day in the drinking water, for 4 days. Chloroform treatment resulted in significant

## 2. HEALTH EFFECTS

increases in liver weights of mice at the 238 and 477 mg/kg/day dose levels. Mice treated with 238 mg/kg chloroform had moderate centrilobular vacuolar degeneration of hepatocytes and scattered centrilobular and subcapsular hepatocyte necrosis. At the 477 mg/kg dose, severe centrilobular coagulative necrosis with small number of inflammatory cells in the necrotic areas was also observed. Dose-dependent increases in both ALT and SDH were also observed. At daily doses of 90 mg/kg or less, no increase in hepatic cell proliferation was noted. Dose-dependent increases in hepatic cell proliferation and cells observed to be in S-phase occurred in the 238 and 477 mg/kg/day doses. For mice dosed with 16, 26, 53, 81, or 105 mg/kg/day in the drinking water, serum ALT or SDH were not different from controls at any dose. In the 53, 81, and 105 mg/kg/day treatment groups, the livers had changes that were characterized by pale cytoplasmic eosinophilic staining of centrilobular hepatocytes compared to the periportal hepatocytes and controls. Livers from mice treated with 26 mg/kg/day chloroform or less failed to show significant histologic changes when compared to controls. Cell proliferations in the liver were not found at any dose or duration. An acute oral MRL of 0.3 mg/kg/day was calculated using the 26.4 mg/kg/day NOAEL based on the hepatic effects in these animals from this study. More information on this MRL and how it was derived is located in the footnote to Table 2-2, Section 2.5, and in Appendix A of this profile.

Larson et al. (1995a) examined the dose-response relationships for the induction of cytolethality and regenerative cell proliferation in the livers of male Fischer 344 rats given chloroform by gavage. Groups of 12 rats were administered oral doses of 0, 3, 10, 34, 90, and 180 mg/kg/day chloroform in corn oil by gavage for 4 days. BrdU was administered via an implanted osmotic pump to label cells in S-phase. Cells having incorporated BrdU were visualized in tissue sections immunohistochemically and the LI evaluated as the percentage of S-phase cells. Necropsies and histopathological examinations were performed at death. The relative liver weights were increased at doses of 10 mg/kg/day and above at 4 days posttreatment. Rats treated with 34, 90, or 180 mg/kg/day by gavage for 4 days had mild-to-moderate degeneration of centrilobular hepatocytes. The livers of rats given 90 mg/kg/day for 4 days had a slight increase in centrilobular pallor and necrosis of hepatocytes surrounding the central vein; the remaining central and some mid-zonal hepatocytes were swollen and displayed a cytoplasmic granularity. In the 180 mg/kg/day dose group, the livers had scattered individual cell necrosis throughout the central and mid-zonal regions. The cytoplasm of the centrilobular hepatocytes were pale, eosinophilic and mildly vacuolated. Dose-dependent increases in both ALT and SDH were observed at 4 days in the 90 and 180 mg/kg/day dose groups and at 3 weeks



## 2. HEALTH EFFECTS

in the 180 mg/kg/day dose group only. A dose-dependent increase in LI was seen in rat liver after 4 days of treatment with 90 and 180 mg/kg/day by gavage.

Larson et al. (1995a) also examined the toxicological effects of chloroform administered in the drinking water in rats. Groups of 12 rats were administered chloroform *ad libitum* in drinking water at concentrations of 0, 60, 200, 400, 900, and 1,800 ppm for 4 days. BrdU was administered via an implanted osmotic pump to label cells in S-phase. Cells having incorporated BrdU were visualized in tissue sections immunohistochemically and the LI evaluated as the percentage of S-phase cells. Necropsies and histopathological examinations were performed at death. Average daily doses of chloroform ingested from drinking water were: 0, 6.6, 19.3, 33.2, 68.1, and 57.5 mg/kg/day for 0, 60, 200, 400, 900, and 1,800 ppm concentration levels, respectively. Only mild hepatocyte vacuolation was observed in rats given 900 or 1,800 ppm in water for 4 days; no increase in the hepatic LI was observed at any time point.

In another study by Larson et al. (1995b), female Fisher 344 rats administered 400 mg/kg chloroform by gavage in corn oil for 4 days exhibited hepatic lesions consisting of mild centrilobular vacuolization, scattered necrotic hepatocytes, sinusoidal leucostasis, mild-to-focally severe centrilobular hepatocyte degeneration and necrosis, and diffuse centrilobular swelling. Rats in the 100 and 200 mg/kg groups had only slight centrilobular changes, while those in the 34 mg/kg group did not differ from controls.

Pereira (1994) investigated the effects of chloroform exposure in different vehicles and by different dosing regimes on hepatic cell proliferation in female B6C3F<sub>1</sub> mice. Animals received either 263 mg/kg/day chloroform by gavage in corn oil or 1,800 ppm chloroform in drinking water, 24 hours a day and were sacrificed at 5 or 12 days. When administered by gavage, chloroform exposure resulted in significantly increased relative liver weights at 5 days (53%;  $p < 0.05$ ), but not at 12 days. The livers of mice exposed to chloroform for 5 days exhibited toxicity consisting of necrotic hepatocytes, infiltration of macrophages and neutrophils in the central zone, and hydrotropic, swollen, and rounded hepatocytes of a pale ground glass appearance in the midzone. Hepatotoxicity was less severe at 12 days. Cell proliferation was significantly increased at both 5 and 12 days. In contrast, chloroform administered in drinking water for 5 days reduced absolute and relative liver weight while exposure for 12 days had no effect on relative liver weights. The livers of mice exposed to chloroform in drinking water exhibited limited toxicity after 5 days consisting of smaller hepatocytes

## 2. HEALTH EFFECTS

with dense nonvacuolated and basophilic cytoplasm; hepatotoxicity after 12 days was limited to vacuolated hepatocytes. Cell proliferation, was significantly reduced ( $p < 0.05$ ) at 5 and 12 days as compared to controls.

Liver effects in animals have been reported in numerous oral studies of intermediate duration (Chu et al. 1982b; Eschenbrenner and Miller 1945a; Larson et al. 1995b). Larson et al. (1994b) exposed female mice to 3, 10, 34, 90, 238, and 477 mg/kg/day of chloroform in corn oil via gavage 5 days a week for 3 weeks. Chloroform treatment resulted in significant increases in liver weights of mice at the 90, 238, and 477 mg/kg/day doses. Doses of 34 mg/kg/day resulted in pale cytoplasmic eosinophilia of the centrilobular hepatocytes and mild vacuolation of the centrilobular and mid-zonal hepatocytes relative the periportal hepatocytes and livers from control mice. At the 238 mg/kg/day dose, the livers were characterized by a severe centrilobular hepatocyte necrosis. At 477 mg/kg/day, the central zone of the liver was populated by degenerate vacuolated hepatocytes and regenerating hepatocytes with markedly basophilic cytoplasm and, small round nuclei with clumped chromatin and prominent nucleoli. Significant dose-dependent increases in ALT and SDH were observed at doses of 34 mg/kg/day and greater. Cell proliferation was markedly increased in the liver at the 238 and 477 mg/kg/day doses. Mice dosed with 16, 43, 82, 184, or 329 mg/kg/day of chloroform in the drinking water for 7 days a week for 3 weeks resulted in no histological changes in livers at all doses studied. Liver weights were significantly increased at 82, 184, and 329 mg/kg/day.

Larson et al. (1995a) examined the dose-response relationships for the induction of cytolethality and regenerative cell proliferation in the livers of male Fischer 344 rats given chloroform by gavage. Groups of 12 rats were administered oral doses of 0, 3, 10, 34, 90, and 180 mg/kg/day chloroform in corn oil by gavage for 5 days a week for 3 weeks. BrdU was administered via an implanted osmotic pump to label cells in S-phase. Cells having incorporated BrdU were visualized in tissue sections immunohistochemically and the LI evaluated as the percentage of S-phase cells. Necropsies and histopathological examinations were performed at death. The relative liver weights were increased at doses of 90 mg/kg/day and greater at 3 weeks. After 3 weeks of exposure, livers of rats in the 34 or 90 mg/kg/day dose groups did not differ from controls. In the 180 mg/kg/day dose group, effects were similar to those seen at 4 days after exposure. Dose-dependent increases in both ALT and SDH were observed after 3 weeks in the 180 mg/kg/day dose group only.

## 2. HEALTH EFFECTS

Larson et al. (1995a) also examined the toxicological effects of chloroform administered in the drinking water in rats. Groups of 12 rats were administered chloroform *ad libitum* in drinking water at concentrations of 0, 60, 200, 400, 900, and 1,800 ppm for 7 days a week for 3 weeks. BrdU was administered via an implanted osmotic pump to label cells in S-phase. Cells having incorporated BrdU were visualized in tissue sections immunohistochemically and the LI evaluated as the percentage of S-phase cells. Necropsies and histopathological examinations were performed at death. Average daily doses of chloroform ingested from drinking water were: 0, 6, 17.4, 32, 62.3, and 106 mg/kg/day for 3 weeks exposure for 0, 60, 200, 400, 900, and 1,800 ppm concentration levels, respectively. Only mild hepatocyte vacuolation was observed in rats given 1,800 ppm in water for 3 weeks. No increase in the hepatic LI was observed at any time point.

Larson et al. (1995b) further examined the dose-response relationship for chloroform-induced cytotoxicity and cell proliferation in the liver of female Fisher 344 rats via gavage. Animals received chloroform in corn oil at doses of 0, 34, 100, 200, or 400 mg/kg/day for 3 weeks (5 days a week). At completion of dosing, animals were sacrificed, the livers were evaluated microscopically and cell proliferation was quantitated. Exposure to 400 mg/kg chloroform resulted in hepatic lesions consisting of slight to mild diffuse vacuolar change and focal centrilobular degeneration. Rats in the 200 mg/kg groups had only slight centrilobular vacuolation, while those in the 100 and 34 mg/kg dose groups did not differ from controls.

Pereira (1994) provided further evidence of the effect of dosing method (gavage versus drinking water) and vehicle (corn oil versus water) on hepatic cell proliferation in female B6C3F<sub>1</sub> mice. Animals received either 263 mg/kg/day chloroform by gavage in corn oil or 1,800 ppm chloroform in drinking water, 24 hours a day and were sacrificed at 33 or 159 days. When administered by corn oil gavage, chloroform exposure resulted in increased relative liver weights at 33 and 159 days (30.1 and 38.2% increases, respectively). The livers of mice exposed to chloroform for 33 or 159 days exhibited limited toxicity consisting of focal areas of necrotic hepatocytes and a limited number of mononuclear cells and swollen, rounded, pale hepatocytes. Cell proliferation was significantly increased at both 33 and 159 days as compared to controls. In contrast, administration of chloroform in drinking water had no effect on absolute or relative liver weights after 33 days, while exposure for 159 days resulted in significantly increased relative liver weights (31.4%;  $p < 0.05$ ). However, the livers of mice exposed for either 33 or 159 days exhibited no signs of toxicity. In addition, cell proliferation was not significantly affected by exposure to chloroform in drinking water for either 33 or 159 days.

## 2. HEALTH EFFECTS

Fatty changes, necrosis, increased liver weight, and hyperplasia have been observed in rats exposed to  $\geq 150$  mg/kg/day chloroform in a toothpaste vehicle via gavage for 13 weeks (Palmer et al. 1979). An increased incidence of sporadic, mild, reversible, liver changes occurred in rats exposed to chloroform in the drinking water at doses of 0.64-150 mg/kg/day for 90 days, but the incidences were not significantly higher than the incidences in controls (Chu et al. 1982a). The effect- and no-effect-levels in the study are clearly defined. Fatty and hydropic changes, necrosis, and cirrhosis were observed in mice treated by gavage with  $\geq 50$  mg/kg/day chloroform in oil for 90 days (Bull et al. 1986; Munson et al. 1982) or 86 mg/kg/day in drinking water for 1 year (Klaunig et al. 1986). In contrast, centrilobular fatty changes observed in mice at 64 mg/kg/day chloroform in drinking water for 90 days appeared to be reversible (Jorgenson and Rushbrook 1980), and no liver effects were found in mice treated with  $\geq 50$  mg/kg/day chloroform in aqueous vehicles (Bull et al. 1986). In addition, hepatocellular degeneration was induced in F<sub>1</sub> females in a 2-generation study in which mice were treated by gavage with 41 mg/kg/day chloroform in oil (Gulati et al. 1988). Significantly increased ( $p < 0.05$ ) SGPT activity occurred in dogs beginning at 6 weeks of exposure to chloroform in toothpaste in capsules at a dose of 30 mg/kg/day in a 7.5-year study (Heywood et al. 1979). SGPT activity was not increased at 15 mg/kg/day until week 130. Therefore, 15 mg/kg/day was the NOAEL for intermediate-duration exposure. This NOAEL was used to derive an intermediate-duration oral MRL of 0.1 mg/kg/day. More information on this MRL and how it was derived is located in the footnote to Table 2-2, Section 2.5, and in Appendix A of this profile.

The relationships among chloroform-induced cytolethality, regenerative cell proliferation, and tumor induction in male B6C3F<sub>1</sub> mice dosed with chloroform by gavage in corn oil has also been studied. Mice received chloroform at doses of 0, 34, 90, 138, or 277 mg/kg for 4 consecutive days or 5 days a week for 3 weeks. To monitor cell proliferation, mice were administered BrU via implanted osmotic pump for the last 3.5 days. Chloroform treatment for 3 weeks also resulted in a small (<10%) but significant increase in relative liver weight of mice at the highest dose level. Macroscopically, pale livers and kidneys were noted at all dose levels after 3 weeks of chloroform exposure; treatment with 138 or 277 mg/kg for 3 weeks resulted in the formation of white subcapsular foci. After 3 weeks of chloroform exposure, the livers of all mice in the 34 mg/kg/day group and 3 of 5 mice in the 90 mg/kg/day group were histologically similar to those of controls. Livers of 2 mice in the 90 mg/kg/day group exhibited centrilobular hepatocyte swelling with loss of eosinophilia. Mice dosed with 138 mg/kg/day experienced marked centrilobular hepatocyte swelling, mild to moderate periportal vacuolation, and scattered centrilobular and periportal degeneration and necrosis. Mice dosed with

## 2. HEALTH EFFECTS

277 mg/kg/day experienced marked centrilobular hepatocyte degeneration and necrosis. Cell proliferation was significantly elevated in the 138 and 277 mg/kg dose groups only.

In chronic-duration exposure studies, liver effects have been observed in rats, mice, and dogs after oral exposure to chloroform. Male and female ICI mice were exposed to 17 or 60 mg/kg/day chloroform by gavage using toothpaste as a vehicle for 80 weeks followed by 13-24-week observation period. No significant histopathological findings (noncancerous) were recorded in the kidneys or lung tissues. Moderate or severe fatty degeneration of the liver was slightly more prevalent among treated animals than controls (statistical significance not provided) beginning at the 17 mg/kg/day. Necrosis was observed in female rats treated by gavage with 200 mg/kg/day chloroform in oil for 78 weeks (NCI 1976). Nodular hyperplasia occurred in all groups of male and female mice similarly treated at 138 and 238 mg/kg/day, respectively. Fibrosis of the liver was observed in both sexes of rats exposed to 200 mg/kg/day chloroform in the drinking water for  $\leq 180$  weeks (Tumasonis et al. 1985, 1987). Increased SGPT was observed in dogs given chloroform in toothpaste capsules for 7.5 years (Heywood et al. 1979). The lowest oral dose administered to animals in chronic studies was 15 mg/kg/day, which increased SGPT in dogs. This LOAEL was used to derive a chronic oral MRL of 0.01 mg/kg/day. More information on this MRL and how it was derived is located in the footnote to Table 2.2, Section 2.5, and in Appendix A of this profile.

**Renal Effects.** The kidney is also a major target of chloroform-induced toxicity in humans. Oliguria was observed 1 day after the ingestion of  $\approx 3,755$  or 2,410 mg/kg chloroform (Piersol et al. 1933; Schroeder 1965). Increased blood urea nitrogen (BUN) and creatinine levels also indicated renal injury. Albuminuria and casts were detected in the urine. Histopathological examination at autopsy revealed epithelial swelling and hyaline and fatty degeneration in the convoluted tubules of kidneys in one fatal case of oral exposure to chloroform (Piersol et al. 1933). Numerous hyaline and granular casts and the presence of albumin were observed in the urine of one subject who ingested 21 mg/kg/day chloroform in cough medicine for 10 years (Wallace 1950). The urinalysis results reversed to normal after discontinuation of chloroform exposure. No indications of renal effects were observed in humans who ingested estimated doses of 0.34-0.96 mg/kg/day chloroform in mouthwash for 5 years (De Salva et al. 1975).

The renal toxicity of chloroform in animals has been reported in many studies of acute duration. Larson et al. (1993) studied the effects of dose and time after chloroform administration on the renal

## 2. HEALTH EFFECTS

toxicology of chloroform in male rats. Rats were given 34, 180, or 477 mg/kg once in corn oil by gavage and sacrificed 24 hours after administration. In a related time-course study (which focused on histologic changes in tissues over time), rats received 180 mg/kg chloroform in corn oil by gavage and were sacrificed at 0.5, 1, 2, 4, and 8 days after treatment; others received 477 mg/kg in corn oil by gavage and were sacrificed either 1 or 2 days after administration. Histologically, chloroform caused extensive renal damage and, to a much lesser extent, hepatic injury, in a dose-related manner. One day after treatment with a single dose of chloroform of 34 mg/kg or greater, the kidneys of male rats developed tubular necrosis that was restricted to the proximal convoluted tubules. The severity of these lesions occurred in a dose-dependent manner. Rats given 34 mg/kg had scattered necrotic tubules affecting less than 10% of the midcortical nephrons. In the 180 mg/kg group, 25% of the proximal convoluted tubules were necrotic. Nearly all segments of the proximal tubules had necrosis in the rats receiving 477 mg/kg chloroform. Despite extensive renal injury, increases in BUN or in urinary protein or glucose were not observed. In the time-course study, the kidneys, after 12 hours of treatment, had a diffuse granularity of cytoplasm of the epithelium lining of the proximal convoluted tubules in the 180 mg/kg group. Damage was severe after 1 day, and after 2 days, 100% of the proximal tubules were lined by necrotic epithelium. After 8 days, the kidneys had returned to normal appearance. No increases in BUN or urinary protein or glucose were noted at any time after treatment.

Larson et al. (1995a) also examined the toxicological effects of chloroform administered in the drinking water in rats. Groups of 12 rats were administered chloroform *ad libitum* in drinking water at concentrations of 0, 60, 200, 400, 900, and 1,800 ppm for 4 days. BrdU was administered via an implanted osmotic pump to label cells in S-phase. Cells having incorporated BrdU were visualized in tissue sections immunohistochemically and the LI evaluated as the percentage of S-phase cells. Necropsies and histopathological examinations were performed at death. Average daily doses of chloroform ingested from drinking water were: 0, 6.6, 19.3, 33.2, 68.1, and 57.5 mg/kg/day for 4 days exposure for the 0, 60, 200, 400, 900, and 1,800 ppm concentration levels, respectively. When chloroform was administered in the drinking water, no microscopic alterations were seen in the kidneys after 4 days of treatment. The overall renal LI was not increased at any dose.

The same study (Larson et al. 1995a) examined the dose-response relationships for the induction of cytolethality and regenerative cell proliferation in the kidneys of male Fischer 344 rats given chloroform by gavage. Groups of 12 rats were administered oral doses of 0, 3, 10, 34, 90, and

## 2. HEALTH EFFECTS

180 mg/kg/day chloroform in corn oil by gavage for 4 days. BrdU was administered via an implanted osmotic pump to label cells in S-phase. Cells having incorporated BrdU were visualized in tissue sections immunohistochemically and the LI evaluated as the percentage of S-phase cells. Necropsies and histopathological examinations were performed at death. Rats treated with 34, 90, or 180 mg/kg/day by gavage for 4 days had mild-to-moderate degeneration of renal proximal tubules. After 4 days of dosing with 34 mg/kg/day, the proximal convoluted tubule epithelial cells had increased numbers and prominence of apical cytoplasmic vacuoles. Likewise, rats given 90 mg/kg/day for 4 days displayed swelling and vacuolation of 25-50% of the proximal tubules. Progressive degeneration of the proximal tubules was observed in rats exposed to 180 mg/kg/day. At 4 days, swollen and vacuolated cytoplasm in approximately 10-20% of proximal tubule epithelium was observed. LI were increased in the kidney cortex only in the rats treated with 180 mg/kg/day for 4 days.

The dose-response relationship for chloroform-induced cytotoxicity and cell proliferation in the kidneys of female Fisher 344 rats has also been elucidated. Animals received 34, 100, 200, or 400 mg/kg chloroform by gavage in corn oil for 4 days. At completion of dosing, kidneys were prepared for microscopic evaluation, and cell proliferation was quantitated. Rats in the high dose group had 50-75% of proximal tubules lined with necrotic or attenuated regenerating epithelium, as well as distal nephrons containing hyaline casts. Rats in the 200 mg/kg group had kidneys with 25-50% of proximal tubules lined with degenerated, necrotic or regenerating epithelium. Kidneys from rats in the 2 lowest dose groups were similar to those of controls (Larson et al. 1995b).

Acute toxic nephrosis was observed in female rats exposed to 516 mg/kg/day chloroform by gavage in oil during Gd 6-15, with maternal lesions characterized by tubular swelling, hydropic or fatty degeneration and necrosis (Thompson et al. 1974). Increased kidney weight was observed in female rats after a single gavage dose of 546 mg/kg chloroform (Chu et al. 1982b). Similarly, rats exposed to 400 mg/kg/day by gavage during gestation had increased kidney weight (Ruddick et al. 1983). No increase in kidney weight was found in the rats treated with 200 mg/kg/day during gestation. Renal necrosis in convoluted tubules was observed in male mice after a single dose of 199 mg/kg chloroform in toothpaste or 65.6 mg/kg chloroform in oil (Moore et al. 1982).

The relationships among chloroform-induced cytolethality, regenerative cell proliferation, and tumor induction in male B6C3F<sub>1</sub> mice dosed with chloroform by gavage in corn oil of acute duration has

## 2. HEALTH EFFECTS

also been reported. Mice received chloroform at doses of 0, 34, 90, 138, or 277 mg/kg/day by gavage for 4 consecutive days. To monitor cell proliferation, mice were administered BrdU via implanted osmotic pump for the last 3.5 days. After four days of exposure, 2 of 4 mice dosed with 34 mg/kg/day and all mice dosed with 90 mg/kg/day or more experienced extensive (>75% of tissue) acute necrosis of the proximal convoluted tubule, characterized by a thin layer of eosinophilic necrotic cellular debris lining the tubular basement membrane. Distal tubules and collecting ducts were filled with hyaline casts. The remaining 2 mice in the 34 mg/kg/day dose group experienced scattered necrosis in proximal convoluted tubules. In the kidneys, significant increases in cell proliferation were noted in all dose groups given chloroform for 4 days. The authors concluded that the results of this study confirmed the sensitivity of the male mouse, relative to the female mouse, to the nephrotoxic effects of chloroform (Larson et al. 1994d).

In intermediate-duration exposures, several studies suggest that mice appeared to be more sensitive than rats to the nephrotoxic effects of chloroform. Rats exposed to 193 mg/kg/day for 28 days (Chu et al. 1982b) or to 160 mg/kg/day chloroform for 90 days (Jorgenson and Rushbrook 1980) in drinking water had no kidney effects. Increased relative kidney weight was observed in rats exposed by gavage to 150 mg/kg/day for 13 weeks, but not in rats exposed to 30 mg/kg/day (Palmer et al. 1979). Chronic inflammatory changes were observed in the kidneys of mice exposed to 50 mg/kg/day chloroform (dissolved in an emulsion prepared with emulphor in water) by gavage (Munson et al. 1982); however, no changes were observed in mice exposed to 41 mg/kg/day by gavage (Gulati et al. 1988) or in mice exposed to 435 mg/kg/day chloroform in drinking water (Jorgenson and Rushbrook 1980). Nonetheless, exposure to 86 mg/kg/day in drinking water for 1 year caused tubular necrosis in mice (Klaunig et al. 1986).

Larson et al. (1995b) examined the dose-response relationship for chloroform-induced cytotoxicity and cell proliferation in the kidneys of female Fisher 344 rats using a wide range of doses. Animals received 34, 100, 200, or 400 mg/kg chloroform by gavage in corn oil for 3 weeks (5 days a week). At completion of dosing, the kidneys were prepared for microscopic evaluation, and cell proliferation was quantitated. Rats in the 100, 200, and 400 mg/kg dose groups had 50-75% of proximal tubules lined with regenerating epithelium; many of the tubules were dilated and contained mineralized concretions. Kidneys from rats in the lowest dose group were similar to those of controls.



## 2. HEALTH EFFECTS

Lipsky et al. (1993) studied groups of male Fischer 344 rats gavaged with either 90 or 180 mg/kg/day of chloroform in corn oil or water for 5 days a week for 4 weeks. Rats exposed to chloroform by gavage in corn oil displayed acute cell injury and necrosis, primarily in the epithelial cells lining the S2 segment of the proximal tubule, with some apparent damage/necrosis occurring in the S1 segment as well. This injury was present in all rats exposed to the 180 mg/kg/day dose and in less than half of the animals exposed to the 90 mg/kg/day dose. There was also a dose-dependent increase in the total BrdU labeling of nuclei in renal cells of the chloroform-treated oil-gavaged animals compared to controls. The largest increase in DNA BrdU labeling was in the cells of the S2 segment. The 90 mg/kg/day dose of chloroform also produced increase in DNA labeling in the S3 segment, but not for the 180 mg/kg/day dose of chloroform. Animals exposed to chloroform in water showed minimal histopathologic alterations in the kidneys. Mild injury and necrosis was seen in cells of the S2 segment in 1 of 6 animals in the 180 mg/kg/day group, while none were seen in the 90 mg/kg/day dose group. Little to no change in DNA labeling of renal cells was seen in the water-gavaged rats.

Larson et al. (1995a) examined the dose-response relationships for the induction of cytolethality and regenerative cell proliferation in the kidneys of male Fischer 344 rats given chloroform by gavage. Groups of 12 rats were administered oral doses of 0, 3, 10, 34, 90, and 180 mg/kg/day chloroform for 5 days a week for 3 weeks. BrdU was administered via an implanted osmotic pump to label cells in S-phase. Cells having incorporated BrdU were visualized in tissue sections immunohistochemically and the LI evaluated as the percentage of S-phase cells. Necropsies and histopathological examinations were performed at death. Relative kidney weights were increased after 3 weeks in the 180 mg/kg/day dose group only. Rats treated with 34, 90, or 180 mg/kg/day by gavage for 4 days had mild-to-moderate degeneration of renal proximal tubules. These alterations were absent or slight after 3 weeks of treatment, except at the highest dose level. After 4 days of dosing with 34 mg/kg/day, the proximal convoluted tubule epithelial cells had increased numbers and prominence of apical cytoplasmic vacuoles, but these changes were not observed at 3 weeks. Likewise, rats given 90 mg/kg/day for 4 days displayed swelling and vacuolation of 25-50% of the proximal tubules, at 3 weeks only 1 of 3 rats had vacuolated and degenerated epithelium. Progressive degeneration of the proximal tubules was observed in rats exposed to 180 mg/kg/day. At 4 days, swollen and vacuolated cytoplasm in approximately 10-20% of proximal tubule epithelium was observed, while at 3 weeks the percentage was 25-50%. At 3 weeks, scattered tubules also had mineral concretions that appeared subepithelial. LI was increased in the kidney cortex only in the rats treated with 180 mg/kg/day for 4 days.

## 2. HEALTH EFFECTS

Larson et al. (1995a) also examined the toxicological effects of chloroform administered in the drinking water in rats. Groups of 12 rats were administered chloroform *ad libitum* in drinking water at concentrations of 0, 60, 200, 400, 900, and 1,800 ppm for 7 days a week for 3 weeks. BrdU was administered via an implanted osmotic pump to label cells in S-phase. Cells having incorporated BrdU were visualized in tissue sections immunohistochemically and the LI evaluated as the percentage of S-phase cells. Necropsies and histopathological examinations were performed at death. Average daily doses of chloroform ingested via drinking water were 0, 6, 17.4, 32, 62.3, and 106 mg/kg/day for 3 weeks exposure for 0, 60, 200, 400, 900, and 1,800 ppm concentration levels, respectively. As a general observation, rats treated for 3 weeks with 200 ppm chloroform and greater had slightly increased numbers of focal areas of regenerating renal proximal tubular epithelium and cell proliferation than were noted in controls, but no clear dose-response relationship was evident. The overall renal LI was not increased at any dose or time point.

Larson et al. (1994b) exposed female mice to 3, 10, 34, 90, 238, and 477 mg/kg/day of chloroform in corn oil via gavage for 5 days a week for 3 weeks. Mice were also dosed with 16, 43, 82, 184, or 329 mg/kg/day of chloroform in the drinking water for 7 day a week for 3 weeks. In both studies, no increases in cell proliferation were noted and no significant changes in renal histopathology were reported.

In another study by Larson et al. (1994d) the possible relationships among chloroform-induced cytolethality, regenerative cell proliferation, and tumor induction were identified in male B6C3F<sub>1</sub> mice dosed with chloroform by gavage in corn oil. Mice received chloroform at doses of 0, 34, 90, 138, or 277 mg/kg/day for 5 days a week for 3 weeks. To monitor cell proliferation, mice were administered BrdU via implanted osmotic pump for the last 3.5 days. Renal lesions were similar to, but less severe than, lesions seen in mice exposed for 4 days and were characterized by extensive tubular regeneration. The kidneys of mice dosed with 34-138 mg/kg/day chloroform exhibited dose-dependent increases in regenerating proximal convoluted tubules. The kidneys of mice dosed with 277 mg/kg/day chloroform exhibited severe nephropathy characterized by degeneration, necrosis, and regeneration of the proximal tubules. The renal interstitium was swollen due to fibroplasia, edema, and inflammatory cell infiltration. After 3 weeks of exposure, renal cell proliferation was still elevated relative to controls at doses of  $\geq 90$  mg/kg/day, but LI values declined from levels seen after 4 days of exposure.

## 2. HEALTH EFFECTS

In chronic oral studies, no definite renal effects were observed in rats exposed to  $\leq 200$  mg/kg/day or mice exposed to  $< 477$  mg/kg/day TWA (Heindel et al. 1995; Jorgenson et al. 1985; NCI 1976; Roe et al. 1979). In dogs, however, fat deposition in renal glomeruli was observed at a dose of 30 mg/kg/day chloroform for 7.5 years, but not at 15 mg/kg/day (Heywood et al. 1979).

**Dermal Effects.** No studies were located regarding dermal effects in humans after oral exposure to chloroform.

Alopecia was observed in pregnant rats exposed to 126 mg/kg/day chloroform in oil (Thompson et al. 1974). Rough coats were observed in mice exposed to 100 mg/kg/day chloroform in oil for 14 days (Gulati et al. 1988).

**Ocular Effects.** Only one reference was located that discussed the ocular effects of chloroform after oral ingestion. Li et al. (1994) examined the effects of chloroform administered in drinking water to guinea pigs with cedar pollen-induced allergic conjunctivitis, prepared by passive cutaneous anaphylaxis. Groups of 5 male Hartley guinea pigs were given drinking water with chloroform concentrations of 0.01, 0.1, 1, 10, 100, or 1,000 ppm 48 hours before applying an antigen eye drop (starting on the 8th day after antiserum administration). One control group was not administered chloroform and another control group was not administered the antiserum (chloroform alone) for every dose level. The light absorption rate of Evans blue extracted from conjunctiva was used as an index of the relative intensity of allergic conjunctivitis. In a separate experiment, using the dose level which caused the most intense aggravating effect in the above testing, groups of 3 male guinea pigs were given 1 ppm chloroform in drinking water for 48 hours and the residual effect on the allergic conjunctivitis was examined. Animals were examined immediately after, and 1, 2, 4, 7, and 14 days after exposure; antigen eye drops were applied 10 days after the antiserum administration. Water intake was monitored and blood chloroform concentrations were measured. At 0.1 ppm chloroform, significant aggravation of allergic conjunctivitis was observed. Allergic conjunctivitis was most intensely aggravated at 1 ppm chloroform. At higher doses (10 and 100 ppm) the aggravation was still noticeable, yet less significant. At 1,000 ppm chloroform, the aggravating effect was not present. Blood chloroform concentrations increased as the concentration in drinking water increased from 0.01 to 1,000 ppm.

## 2. HEALTH EFFECTS

**Body Weight Effects.** No studies were located regarding body weight effects in humans after oral exposure to chloroform.

Several studies were located regarding body weight changes in animals after oral exposure to chloroform; however, the effect of chloroform on body weight is variable and depends somewhat on the dose and dosing method. Body weight was unaffected in male Wistar rats receiving single doses of chloroform ranging from 0.1 to 0.5 mL/kg (Nakajima et al. 1995), in female B6C3F<sub>1</sub> mice exposed to 263 mg/kg/day chloroform by gavage in corn oil for 5 or 12 days (Pereira 1994), and in male rats exposed once to 477 mg/kg day of chloroform (Larson et al. 1993), or for 4 days in male mice dosed at 277 mg/kg/day by gavage (Larson et al. 1994d). When female mice were exposed to 1,800 ppm chloroform in drinking water (24 hours a day) for 5 or 12 days, body weight initially declined; however, this was attributed to decreased water consumption (Pereira 1994). A dose-related decrease in body weight gain was observed in rats exposed to 100 mg/kg/day and in rabbits exposed to 50 mg/kg/day chloroform by gavage in oil during gestation (Ruddick et al. 1983; Thompson et al. 1974). In addition, decreased body weight was observed in male mice after acute exposure to 250 mg/kg/day chloroform by gavage in oil (Gulati et al. 1988; Munson et al. 1982). Others have reported similar reductions in body weight after oral dosing with chloroform (Davis and Berndt 1992, 1994b, 1995a, 1995b; Reddy et al. 1992).

In studies of intermediate duration, dose-related decreases in body weight or body weight gain were observed in rats exposed to  $\geq 81$  mg/kg/day in water (Jorgenson and Rushbrook 1980) or in oil (Larson et al. 1994b, 1995b; NCI 1976) and in mice (Bull et al. 1986; Klaunig et al. 1986; Roe et al. 1979). Similar effects were found in rats exposed to  $\geq 60$  mg/kg/day regardless of the vehicle (Jorgenson et al. 1985; Larson 1995a; NCI 1976; Palmer et al. 1979; Tumasonis et al. 1985) and mice exposed to 263 mg/kg/day in water (Jorgenson et al. 1985) in studies of chronic exposure; taste aversion may have been a complicating factor in these studies. In contrast, no effect on body weight was observed in mice treated with 477 mg/kg/day by gavage in oil (NCI 1976) or dogs treated with 30 mg/kg/day chloroform (Heywood et al. 1979) in studies of chronic duration. Food and/or water consumption were decreased in chloroform-exposed animals in some studies (Chu et al. 1982a; Jorgenson and Rushbrook 1980), but others reported fluctuating food intake unrelated to chloroform exposure (Palmer et al. 1979) or no significantly depressed food consumption at the lowest LOAEL level for body weight effects (Thompson et al. 1974). The effects chloroform has on changes in body weight and water consumption when administered orally in different vehicles and varying doses have also been

## 2. HEALTH EFFECTS

reported in female mice (Pereira 1994). In this study, female B6C3F<sub>1</sub> mice received 263 mg/kg/day chloroform by gavage in corn oil or 1,800 ppm/day chloroform in their drinking water, and animals were sacrificed at 5, 12, 33, or 159 days. Chloroform administered by gavage did not affect body weight; however, when administered in drinking water, body weights in exposed animals initially declined, but increased by day 33 to control levels. This was attributed to changes in drinking-water consumption, which was suppressed during the first 5 days but was greater than that of controls from days 6-12.

### 2.2.2.3 Immunological and Lymphoreticular Effects

No studies were located regarding immunological effects in humans after oral exposure to chloroform. Information regarding immunological effects in animals after oral exposure to chloroform is limited to three studies. Reduced lymphocyte counts were observed in female rats after a single gavage dose of 1,071 mg/kg chloroform (Chu et al. 1982b); no effects were observed in the 765 mg/kg group. Humoral immunity, defined as antibody-forming cells (AFC)/spleen x 100,000, was depressed in both sexes of mice after oral dosing with 50 mg/kg/day chloroform for 14 days (Munson et al. 1982). In contrast, hemagglutination titer was not significantly influenced, and no changes in cell-mediated immunity were recorded. Similar results were obtained in a 90-day experiment (Munson et al. 1982). Depressed humoral immunity was observed in mice exposed to 50 mg/kg/day chloroform. Cell-mediated immunity (delayed-type hypersensitivity) was affected in the high-dose (250 mg/kg/day) group of females. The chloroform-induced changes were more marked in the 14-day study than in the 90-day study. Although the data are limited, there are indications that the immune system is a target of chloroform-induced toxicity after oral exposure. The data also indicate that humoral immunity may be more severely affected than cell-mediated immunity. These conclusions, however, should be viewed with caution due to the small number of studies.

Li et al. (1994) examined the effects of chloroform administered in drinking water to guinea pigs with cedar pollen-induced allergic conjunctivitis, prepared by passive cutaneous anaphylaxis. Groups of 5 male Hartley guinea pigs were given drinking water with chloroform concentrations of 0.01, 0.1, 1, 10, 100, or 1,000 ppm 48 hours before applying an antigen eye drop (starting on the 8th day after antiserum administration). At 0.1 ppm chloroform, significant aggravation of allergic conjunctivitis was observed. Allergic conjunctivitis was most intensely aggravated at 1 ppm chloroform. At higher

## 2. HEALTH EFFECTS

doses (10 and 100 ppm) the aggravation was still noticeable, yet less significant. At 1,000 ppm chloroform, the aggravating effect was not present.

The highest NOAEL value and all reliable LOAEL values for immunological effects in each species and duration category are recorded in Table 2-2 and plotted in Figure 2-2.

### 2.2.2.4 Neurological Effects

The data regarding neurological effects in humans after oral exposure to chloroform were obtained from clinical case reports. Deep coma occurred immediately after exposure to 2,410 or 3,755 mg/kg in all cases of intentional or accidental ingestion of chloroform (Piersol et al. 1933; Schroeder 1965; Storms 1973). All reflexes were abolished, and pupil size varied. All patients survived the first coma and became fully conscious; however, one patient died in coma several days later due to extensive liver necrosis (Piersol et al. 1933). Mild cerebellar damage (instability of gait, intentional tremor) was observed in one patient, but reversed to normal in two weeks (Storms 1973).

The central nervous system in animals is a target of chloroform toxicity after oral exposure to chloroform. High single doses of chloroform caused ataxia, incoordination, and anesthesia in mice (Balster and Borzelleca 1982; Bowman et al. 1978). Sprague-Dawley rats administered a single 200 mg/kg dose of chloroform gavage experienced significant decreases in midbrain 5-hydroxyindolacetic acid (5-HIAA) levels and significant increases in hypothalamic dopamine concentrations 2 hours after dosing ( $p < 0.05$ ) (Kanada et al. 1994). The calculated ED<sub>50</sub> (dose is effective on 50% of animals) for motor performance was 484 mg/kg chloroform (Balster and Borzelleca 1982). The effects disappeared within 90 minutes postexposure. A minimal narcotic dose for 50% of the treated mice was calculated to be 350 mg/kg (Jones et al. 1958). Hunched posture and inactivity were observed in male mice exposed by gavage to 250 mg/kg chloroform in oil for 14 days (Gulati et al. 1988). No effects were observed after exposure to 100 mg/kg day. Hemorrhaging in the brain was observed during gross pathological examinations of mice that died under chloroform anesthesia following doses  $\geq 500$  mg/kg/day (Bowman et al. 1978). Lower concentrations of chloroform-induced taste aversion to a saccharin solution in mice exposed by gavage for 10 days to 30 mg/kg/day in oil, but not in mice exposed to 10 mg/kg/day (Landauer et al. 1982). No signs of behavioral toxicity were observed in mice exposed to 31.1 mg/kg/day chloroform for 14, 60, or 90 days, or in mice exposed to 100 mg/kg for 30 days (Balster and Borzelleca 1982). Operant behavior in mice was affected after exposure to

## 2. HEALTH EFFECTS

100 mg/kg/day for 60 days (Balster and Borzelleca 1982). The most severe effects were observed early in the experiment; partial tolerance was observed later. No histopathological changes were observed in the brains of rats after chronic exposure to 200 mg/kg/day, in the brains of mice after chronic exposure to 477 mg/kg/day (NCI 1976) or in the brains of mice after chronic exposure to 60 mg/kg/day (Roe et al. 1979).

The highest NOAEL values and all reliable LOAEL values for neurological effects in each species and duration category are recorded in Table 2-2 and plotted in Figure 2-2.

### 2.2.2.5 Reproductive Effects

No definitive studies were located regarding reproductive effects in humans after oral exposure to chloroform. However, in a study by Bove et al. (1995), the effects of drinking-water consumption on birth outcomes were evaluated in women giving birth in northern New Jersey during the period of Jan 1, 1985 to Dec 31, 1988. A total of 80,938 live births and 594 fetal deaths were studied. Exposure to total trihalomethane (TTHM) levels  $>0.1$  ppm resulted in a 70.4 g reduction in mean birth weight among term babies, increased odds ratio (OR) for low birth weight among term births (1.42), an increased OR for reduced size at gestational age birth (1.50) and an increased OR for oral cleft defects (3.17). In addition, exposure to TTHM of  $>0.08$  ppm resulted in an increased OR for central nervous system defects (2.59) and neural tube defects (2.96). The results of this study should be viewed with caution since the outcomes data were not correlated directly with chloroform concentrations, but rather with TTHM concentrations; hence, the effects observed may be due to exposure to other THMs. The authors of this study also acknowledged the presence of other non-THM contaminants, and that some or all of these contaminants may have contributed to the observed effects as well.

In rats, increased resorptions were observed at a dose of 316 mg/kg/day chloroform during gestation but not at 300 mg/kg/day; increased resorptions were also observed in rabbits exposed to 100 mg/kg/day during gestation (Thompson et al. 1974). Furthermore, abortions (not otherwise specified) were observed in rabbits exposed to 63 mg/kg/day chloroform during gestation (Thompson et al. 1974). No histopathological changes were observed in the testes of rats exposed to 160 mg/kg/day chloroform in drinking water for intermediate durations (Jorgenson and Rushbrook 1980). Gonadal atrophy was observed in both sexes of rats treated by gavage with 410 mg/kg/day

## 2. HEALTH EFFECTS

chloroform in toothpaste (but not with 150 mg/kg/day) (Palmer et al. 1979). In a 2-generation reproductive study in mice, exposure to 41 mg/kg/day of chloroform by gavage in oil did not affect the fertility in either generation (Gulati et al. 1988). No remarkable histopathological differences regarding the reproductive system were observed in dogs receiving up to 30 mg/kg/day of chloroform delivered in toothpaste capsules for 7.5 years (Heywood et al. 1979). No histopathological changes were observed in the reproductive organs of male and female rats and mice chronically exposed to 200 and 477 mg/kg/day chloroform via gavage (NCI 1976).

The highest NOAEL values and all reliable LOAEL values for reproductive effects in each species and duration category are recorded in Table 2-2 and plotted in Figure 2-2.

### 2.2.2.6 Developmental Effects

One study (Kramer et al. 1992) was located regarding developmental effects in humans after oral exposure to chloroform via the drinking water. The study was conducted to determine whether water supplies containing relatively high levels of chloroform and other THMs within the state of Iowa are associated with low birth weight, prematurity, or intrauterine growth retardation (the most sensitive end point). Subjects selected include 159 low-birth-weight infants, 342 premature infants, and 187 grow-thretarded infants; however, case definitions were not mutually exclusive. Infants studied were divided into three groups: those who lived in areas where the water supply had undetectable amounts of chloroform, those who lived in areas where the water supply had 1-9 µg/L chloroform, and those who lived in areas where the water supply had more than 10 µg/L. The estimated relative risk of low birth weight associated with drinking-water sources having chloroform levels of greater than or equal to 10 µg/L was 30% higher than the risk for sources with undetectable levels of chloroform. Prematurity was not associated with chloroform/THM exposure. The estimated relative risk of intrauterine growth retardation associated with drinking-water supplies with chloroform concentration of >10 µg/L was 80% more than the risk for those sources with undetectable levels of chloroform. Sources with intermediate chloroform levels (1-9 µg/L) had an elevated risk of 30%. The authors concluded that there is an increased risk of intrauterine growth retardation associated with higher concentrations of waterborne chloroform and dichlorobromomethane; however, it also should be noted that other organic halides that can co-occur in chlorinated drinking water (haloacetic acids and haloacetonitriles) produce developmental effects in animals.



## 2. HEALTH EFFECTS

No teratological effects or skeletal anomalies in rats or rabbits after oral exposure to chloroform were reported in developmental studies (Ruddick et al. 1983; Thompson et al. 1974). Decreased fetal weight was observed in the offspring of rats exposed by gavage to 400 mg/kg/day chloroform during gestation, but not in those exposed to 200 mg/kg/day (Ruddick et al. 1983). In a preliminary dose-finding study, decreased fetal weight and increased resorptions were observed in rats exposed to 316 mg/kg/day chloroform during gestation (Thompson et al. 1974). In the principal study, reduced birth weight of the offspring was reported in the 126 mg/kg/day group; no effects were observed in the 50 mg/kg/day exposure group. No behavioral effects were observed in the offspring of the F<sub>0</sub> generation mice treated for 6-10 weeks with 31.1 mg/kg chloroform (Burkhalter and Balster 1979).

In a 2-generation reproductive study, increased epididymal weights and degeneration of epididymal ductal epithelium were observed in mice in the F<sub>1</sub> generation dosed with 41 mg/kg/day in oil (Gulati et al. 1988). The production and viability of sperm was not affected, however. Swiss mice given drinking water containing a mixture of contaminants including 7 ppm chloroform experienced no significant developmental effects. In the same study, Sprague-Dawley rat pups of the F<sub>1</sub> generation had lower body weights from birth through mating; however, this was likely an artifact of decreased water intake. No other developmental effects were noted (Heindel et al. 1995). These data are limited by the possible interactions caused by the concurrent exposure to other water contaminants.

The highest NOAEL values and all reliable LOAEL values for developmental effects in each species and duration category are recorded in Table 2-2 and plotted in Figure 2-2.

### 2.2.2.7 Genotoxic Effects

No studies were located regarding genotoxic effects in humans after oral exposure to chloroform.

Unscheduled DNA synthesis (UDS) in hepatocytes was not increased in rats exposed to chloroform at gavage doses  $\geq 400$  mg/kg in oil (Mirsalis et al. 1982). Exposure to 200 mg/kg/day chloroform in oil by gavage for 4 days increased sister chromatid exchange frequency in bone marrow cells of mice (Morimoto and Koizumi 1983). Other genotoxicity studies are discussed in Section 2.5.

## 2. HEALTH EFFECTS

### 2.2.2.8 Cancer

Epidemiology studies suggest an association between cancer in humans and the consumption of chlorinated drinking water, but the results are not conclusive at this time (Alavanja et al. 1978; Cantor et al. 1978; Ijsselmuiden et al. 1992; McGeehin et al. 1993; Young et al. 1981; Zierler et al. 1988). Such an association implicates chloroform because chloroform is a known animal carcinogen (see below) and is the predominant THM in chlorinated drinking water (see Chapter 5); however, it is important to note that some of the many chemicals produced in the process of water chlorination are highly mutagenic and/or carcinogenic. Although attempts were made to control for various demographic variables in all of these studies (e.g., social class, ethnic group, marital status, occupation, urban or rural, etc.), many confounding effects remained unaccounted for, most notably the likelihood that numerous chemicals other than chloroform were present in the drinking water, as stated above. Furthermore, the studies differed regarding the type of cancer associated with consumption of chlorinated water. Bladder cancer was reported to have the strongest association with chlorinated water in several studies (Cantor et al. 1978; McGeehin et al. 1993; Zierler et al. 1988), but only colon cancer had an elevated OR (3.6) in another study (Young et al. 1981). In addition, Ijsselmuiden et al. (1992) found the use of municipal water to be associated with pancreatic cancer. All these studies superficially suggest that low-level oral chloroform consumption may increase the risk of some cancers in humans; however, it is equally important to note that most of these studies had confounding factors that make it difficult to definitively state that chloroform is the chemical chiefly responsible for the induction of these specific types of cancer. Confounding factors, such as the presence of other THMs (i.e., brominated THMs), haloacetic acids, haloacetonitriles, halogenated aldehydes, ketones and furanones, and chlorine content (both free and total), all of which may vary widely from one chlorinated drinking-water source to another, may have a large influence on the incidence of these cancers. In addition, many of these studies did not account for migration and historical exposures to any THMs, the wide ranges of potential exposure doses, occupational exposures to other chemicals, and the lack of a direct measurement of chloroform (or other THM) consumption in the drinking-water source (Cantor et al. 1978; Ijsselmuiden et al. 1992; Young et al. 1981; Zierler et al. 1988). Overall, the human data are insufficient to support any conclusion regarding the carcinogenic potential of orally consumed chloroform in humans.

Differing results on the carcinogenic capabilities of chloroform have been demonstrated in laboratory animals. Chloroform is carcinogenic in laboratory animals after oral exposure in some studies of

## 2. HEALTH EFFECTS

intermediate durations. An increased incidence of hepatomas was observed in mice exposed by gavage for 30 days to 594 mg/kg/day chloroform in oil, but not in mice exposed to 297 mg/kg/day (Eschenbrenner and Miller 1945a). An 8-week exposure to 1,800 mg/kg/day chloroform in oil by gavage did not induce lung tumors in mice (Stoner et al. 1986). Chloroform in corn oil acted as a promoter rather than an initiator of preneoplastic foci in a rat liver bioassay (Deml and Oesterle 1985). In addition, no increase in tumors was found in mice exposed to 257 mg/kg/day chloroform in drinking water for 52 weeks (Klaunig et al. 1986). Interestingly, Reddy et al. (1992) dosed male rats with 14, 25, 52, and 98 mg/kg/day of chloroform in the drinking water for 12 weeks. The study conclusively showed that chloroform, at the doses administered and routes studied in the rat, reduced the number of preneoplastic enzyme-altered foci (gamma-glutamyltranspeptidase-positive and GSH S-transferase-positive) in the liver of male rats after induction of foci with diethylnitrosamine in a dose-related fashion. The exact mechanism behind this effect was not determined.

Chloroform was found to be carcinogenic in several chronic animal studies of oral exposure. Renal tumors (tubular cell adenoma and carcinoma) were observed in male Osborne-Mendel rats after a 78-week exposure to 90 mg/kg/day chloroform by gavage in corn oil (NCI 1976). Dunnick and Melnick (1993) demonstrated the incidence of liver and kidney tumors in rats and mice dosed by gavage in corn oil for 5 days a week for 78 weeks. In rats, kidney tubular cell neoplasms did not occur in controls but were observed at 90 mg/kg/day (4 of 50) and at 180 mg/kg/day (12 of 50) in males, and at 200 mg/kg/day (2 of 48) in females. In male mice, hepatocellular neoplasms were rarely seen in controls (1 of 18), but were frequently observed in the 138 mg/kg group (18 of 50) and 277 mg/kg group (44 of 45). In female mice, no hepatocellular neoplasms were recorded in controls but were observed in the 238 mg/kg group (36 of 45) and 477 mg/kg group (39 of 41). The incidence of hepatic neoplastic nodules was increased in female Wistar rats chronically exposed to 200 mg/kg/day chloroform in drinking water (Tumasonis et al. 1987). An increased incidence of tubular cell adenoma and carcinoma was observed in the kidneys of Osborne-Mendel rats chronically exposed to 160 mg/kg/day chloroform in drinking water but not in those exposed to 81 mg/kg/day (Jorgenson et al. 1985). The 160 mg/kg/day dose in this study also resulted in decreased water consumption (taste aversion). In contrast, no increase in the incidence of tumors was observed in Sprague-Dawley rats exposed by gavage to 60 and 165 mg/kg/day chloroform in toothpaste for 80 and 52 weeks, respectively (Palmer et al. 1979). Hepatocellular carcinoma was observed in all groups of male B6C3F<sub>1</sub> mice exposed to gavage doses  $\geq 138$  mg/kg/day chloroform in oil for 78 weeks (NCI 1976). An increased incidence of kidney tumors was observed in ICI mice chronically exposed to

## 2. HEALTH EFFECTS

60 mg/kg/day chloroform by gavage, but not in those exposed to 17 mg/kg/day (Roe et al. 1979). Under the same experimental conditions, chloroform exposure had no effect on the frequency of tumors in C57BL, CBA, and CF-1 mice. Moreover, no increase in tumor incidence was observed in B6C3F<sub>1</sub> mice exposed to 263 mg/kg/day chloroform in drinking water for 2 years (Jorgenson et al. 1985). Cancer was not observed in dogs exposed to 30 mg/kg/day chloroform in toothpaste capsules for 7.5 years (Heywood et al. 1979). From these data it would appear that the method of dosing (e.g., gavage versus drinking water) and the vehicle utilized may influence outcomes in chronic trials. The CELs (cancer effect levels) are recorded in Table 2-2 and plotted in Figure 2-2. EPA (IRIS 1995) selected the study by Jorgenson et al. (1985) as the basis for the  $q_1^*$  for oral exposure to chloroform because administration via drinking water better approximates oral exposure in humans than does administration in corn oil by gavage as used in the NCI (1976) study. Based on the incidence of renal tumors in male Osborne-Mendel rats, the  $q_1^*$  was calculated to be  $6.1 \times 10^{-3} \text{ (mg/kg/day)}^{-1}$ . The oral doses associated with individual lifetime upper-bound risks of  $10^{-4}$  to  $10^{-7}$  are  $1.6 \times 10^{-2}$  to  $1.6 \times 10^{-5}$  mg/kg/day, respectively, and are plotted in Figure 2-2.

### 2.2.3 Dermal Exposure

#### 2.2.3.1 Death

No studies were located regarding death in humans after dermal exposure to chloroform.

No deaths resulted from dermal exposure of rabbits exposed to doses of up to 3,980 mg/kg chloroform for 24 hours (Torkelson et al. 1976).

#### 2.2.3.2 Systemic Effects

No studies were located regarding respiratory, cardiovascular, gastrointestinal, hematological, musculoskeletal, or ocular effects in humans or animals after dermal exposure to chloroform.

**Hepatic Effects.** No studies were located regarding hepatic effects in humans after dermal exposure to chloroform.

## 2. HEALTH EFFECTS

No hepatic effects were observed in rabbits when 3,980 mg/kg chloroform was applied to the abdominal skin for 24 hours (Torkelson et al. 1976). The NOAEL for hepatic effects is recorded in Table 2-3.

**Renal Effects.** No studies were located regarding renal effects in humans after dermal exposure to chloroform.

Renal degenerative tubular changes were observed in rabbits when 1,000 mg/kg chloroform was applied to the abdominal skin for 24 hours (Table 2-3) (Torkelson et al. 1976).

**Dermal Effects.** Completely destroyed stratum corneum was observed in the skin of 2 young volunteers exposed to chloroform for 15 minutes on 6 consecutive days (Malten et al. 1968). Milder changes were observed in two older individuals. Chloroform was applied in a glass cylinder (exact exposure was not specified).

A clinical study of 21 females and 21 males used to determine the efficacy of using aspirin dissolved in chloroform which was then applied topically to patients infected with herpes zoster and post-therapeutic neuralgia with painful skin lesions has been reported. When an aspirin/chloroform combination (approximately 43.3 mg/mL) was applied, the only reported side-effect was an occasional burning sensation on the skin as the chloroform evaporated from the skin surface; however, the possible impact on other major body organs (liver, kidney, etc.) was not investigated (King 1993).

Application of 0.01 mL chloroform for 24 hours to the skin of rabbits caused only slight irritation (Smyth et al. 1962). Skin necrosis was observed in rabbits dermally exposed to 1,000 mg/kg chloroform for 24 hours (Torkelson et al. 1976). These LOAEL values are recorded in Table 2-3.

**Body Weight Effects.** No studies were located regarding body weight effects in humans after dermal exposure to chloroform.

Dermal exposure to 1,000 mg/kg chloroform for 24 hours caused weight loss in rabbits (Table 2-3) (Torkelson et al. 1976).

Table 2-3. Levels of Significant Exposure to Chloroform - Dermal

Species/ (strain)	Exposure/ duration/ frequency	System	NOAEL	LOAEL		Reference
				Less Serious	Serious	
<b>ACUTE EXPOSURE</b>						
<b>Systemic</b>						
Rabbit (New Zealand)	24 hr	Dermal		0.01mL M (slight skin irritation)		Smyth et al. 1962
Rabbit (NS)	24 hr	Hepatic	3980 mg/kg			Torkelson et al. 1976
		Renal		1000 mg/kg	(degenerative tubular changes)	
		Dermal			1000 (necrosis) mg/kg	
		Bd Wt		1000 mg/kg	(unspecified weight loss)	

Bd Wt = body weight; hr = hour(s); LOAEL = lowest-observed-adverse-effect-level; M = male; NOAEL = no-observed-adverse-effect-level; NS = not specified

## 2. HEALTH EFFECTS

No credible studies were located regarding the following health effects in humans or animals after dermal exposure to chloroform:

### **2.2.3.3 Immunological and Lymphoreticular Effects**

### **2.2.3.4 Neurological Effects**

### **2.2.3.5 Reproductive Effects**

### **2.2.3.6 Developmental Effects**

### **2.2.3.7 Genotoxic Effects**

Genotoxicity studies are discussed in Section 2.5.

### **2.2.3.8 Cancer**

No studies were located regarding cancer in humans or animals after dermal exposure to chloroform.

## **2.3 TOXICOKINETICS**

**Overview.** Sufficient information exists on the absorption, distribution, metabolism, and excretion of chloroform, with most information on the pharmacokinetics being derived from animal data. Generally, chloroform is absorbed easily into the blood from the lungs after inhalation exposures. Following oral exposure, peak blood levels are achieved within 5-6 minutes, depending on the dosing vehicle and dosing frequency used. The chemical properties of chloroform also permit percutaneous absorption without difficulty. After absorption, chloroform has been reported to distribute to adipose tissues, brain, liver, kidneys, blood, adrenals, and embryonic neural tissues. Higher levels of chloroform can be found in the renal cortex of male animals than in female animals, a finding apparently mediated by the presence of testosterone. Approximately 50% of a dose of chloroform is eventually metabolized to carbon dioxide in humans; however, an intermediate toxic metabolite, phosgene, is formed in the process in the liver. Chloroform undergoes metabolism primarily in the liver and may undergo covalent binding to both lipid and microsomal protein. Chloroform is excreted from the body either unchanged by pulmonary desorption or in the form of carbon dioxide, with small amounts of either detectable in the urine and feces.

## 2. HEALTH EFFECTS

### 2.3.1 Absorption

#### 2.3.1.1 Inhalation Exposure

Chloroform absorption depends on the concentration in inhaled air, the duration of exposure, the blood/air partition coefficient, the solubility in various tissues, and the state of physical activity which influences the ventilation rate and cardiac output. Pulmonary absorption of chloroform is also influenced by total body weight and total fat content, with uptake and storage in adipose tissue increasing with excess body weight and obesity.

In inhalation exposures, the arterial blood concentration of chloroform is directly proportional to the concentration in inhaled air. At anesthetic concentrations (8,000-10,000 ppm), steady-state arterial blood concentrations of chloroform were 7-16.2 mg/mL (Smith et al. 1973). Total body equilibrium with inspired chloroform concentration required at least two hours in normal humans at resting ventilation and cardiac output (Smith et al. 1973).

The amount of chloroform absorbed and exhaled from the body in alveolar air from male and female swimmers in indoor swimming pools in Italy was measured by Aggazzotti et al. (1993). Alveolar air samples were collected from both swimmers and observers present in indoor chlorinated swimming pools. Of all the nonexposed subjects, 47% had chloroform concentrations below the detection limit of the assay, and the remainder of this control group had low concentrations ( $75.39 \text{ nmol/m}^3$ ) of chloroform present in their alveolar air. Median alveolar chloroform concentrations for persons exposed to the indoor swimming pools (swimmers and observers), were significantly higher than those of nonexposed subjects (median= $695.02 \text{ nmol/m}^3$ ). No differences were found between males and females in any exposure group.

Cammann and Huebner (1995) attempted to correlate chloroform exposure with blood and urine chloroform concentrations in persons using indoor swimming pools. Water and air samples were collected from three swimming pools in Germany, with blood and urine samples collected from attendants, normal swimmers, and agonistic swimmers before and after environmental exposure. Pool water chloroform levels ranged from 3.04 to 27.8  $\mu\text{g/L}$ , while air concentrations ranged from 7.77 to 191  $\mu\text{g/m}^3$ . In general, blood chloroform levels increased with exposure. Blood levels were lowest in attendants (0.13-2.45  $\mu\text{g/L}$ ), followed by normal swimmers (0.56-1.65  $\mu\text{g/L}$ ) and agonistic swimmers



## 2. HEALTH EFFECTS

(1.14-5.23 µg/L). Based upon the differences seen in the two swimming groups, the authors concluded that increased physical activity leads to increased absorption and/or ingestion of chloroform.

In a similar study, Levesque et al. (1994) attempted to quantitate the body burden of chloroform following exposure in an indoor pool. Scuba divers were exposed to chloroform-laden water and air on each of seven days. On each exposure day, the subjects exercised for a 55-minute period; alveolar air samples were collected before exercise and after 35 or 55 minutes of exercise. Pre-exercise alveolar levels of chloroform averaged 52.6 ppb; this was attributed to air contamination in the locker room. Alveolar air concentrations of chloroform after 35 and 55 minutes of exercise increased steadily through day 5, averaging 100-950 and 104-1,093 ppb, respectively. On day 6, when scuba gear was worn by the subjects, alveolar air concentrations after 35 and 55 minutes of exercise were 196 and 209 ppb, respectively. The authors concluded from this data that the average proportion of body burden due to inhalation after 35 and 55 minutes exercise was 76 and 78%, respectively.

Nashelsky et al. (1995) described one non-fatal assault and three deaths-in which chloroform was utilized. Blood and/or tissue concentrations of chloroform were determined in the assault victim and one decedent within 24 hours, within 10 days in another decedent who was frozen for the majority of that period, and after 5 months without preservation in the last decedent. Blood concentrations in 2 decedents were 2 and 3 µg/mL; fat concentrations were 10 and 42 µg/mL; brain concentrations were 3 and 46 µg/mL; and the liver concentration in one decedent was 24 µg/mL. Due to the nature of the tissues analyzed, these data should be regarded as qualitative indicators of chloroform absorption only.

No studies were located regarding absorption in animals after inhalation exposure to chloroform. Evidence that chloroform is absorbed after inhalation exposure is provided in toxicity studies (see Section 2.2.1), but the rate and extent cannot be determined from the toxicity data.

### 2.3.1.2 Oral Exposure

In one case report, a 33-year-old female (weight not reported) injected herself intravenously with 0.5 mL of chloroform and became unconscious. She awoke approximately 12 hours later and drank another 120 mL of chloroform. Plasma chloroform levels were determined 18 hours after ingestion by gas chromatography (GC) and showed a blood chloroform level of 0.66 mg/dL. Subsequent serum

## 2. HEALTH EFFECTS

samples were analyzed for chloroform content and were reported to have been less than this level, steadily declining over time (Rao et al. 1993).

Absorption of an oral dose of  $^{13}\text{C}$ -labeled chloroform (0.5 grams in a gelatin capsule) was rapid in volunteers, reaching peak blood levels in 1 hour (Fry et al. 1972). Almost 100% of the dose was absorbed from the gastrointestinal tract.

Experiments in mice, rats, and monkeys indicate that oral doses (60 mg/kg) of  $^{14}\text{C}$ -labeled chloroform in olive oil were almost completely absorbed as indicated by a 80-96% recovery of radioactivity in expired air, urine, and carcass (Brown et al. 1974a; Taylor et al. 1974). Absorption in mice and monkeys was rapid; the peak blood levels were reached 1 hour after oral administration of 60 mg/kg chloroform in olive oil.

Intestinal absorption of chloroform in either water or corn oil administered intragastrically to rats was rapid with both vehicles, but the rate and extent of absorption varied greatly (Withey et al. 1983). The peak concentration of chloroform in blood was 39.3  $\mu\text{g}/\text{mL}$  when administered in water and 5.9  $\mu\text{g}/\text{mL}$  when administered in corn oil. The greater degree of absorption following administration in water can be explained by the faster partitioning of a lipophilic compound such as chloroform with mucosal lipids from an aqueous vehicle. Peak blood concentrations were reached somewhat more rapidly with the water vehicle (5.6 minutes as opposed to 6 minutes for corn oil). The uptake from a corn oil solution was more complex (pulsed) than from aqueous solution. A possible explanation for this behavior is that the chloroform in corn oil was broken up into immiscible globules, some of which did not come into contact with the gastric mucosa. Another possible explanation was that intragastric motility may have separated the doses into aliquots that were differentially absorbed from the gastrointestinal tract. In a similar study, Pereira (1994) investigated the uptake and protein binding of chloroform in the liver and kidney in female B6C3F<sub>1</sub> mice. Animals received single doses of chloroform by gavage in either water or corn oil. Uptake of chloroform from water into the liver peaked in 1.5 minutes, and hepatic uptake during the first 20 minutes exceeded that of chloroform delivered in oil. During the first 20 minutes after dosing, binding of chloroform to macromolecules in the liver was greater when water vehicle was utilized; beyond 20 minutes, the amount of binding was equivalent between the 2 vehicle groups. Renal uptake of chloroform from water exceeded uptake of chloroform from oil over the entire 4-hour period. The extent of binding to macromolecules in

## 2. HEALTH EFFECTS

kidneys was consistently greater in the group given chloroform in water. Differences in chloroform toxicity based on the vehicle have also been recently reported elsewhere (Larson et al. 1994b, 1995a)

### 2.3.1.3 Dermal Exposure

A limited number of experimental studies were located regarding dermal absorption of chloroform in humans. Levesque et al. (1994) attempted to quantitate the body burden of chloroform following dermal and inhalation exposure in an indoor swimming pool. Male scuba divers were exposed to chloroform-laden water and air on each of seven days. On each exposure day the subjects exercised for a 55-minute period. On day 6 of the experiment, subjects wore scuba gear so as to determine the percentage body burden due to dermal exposure. On day 6, when scuba gear was worn by the subjects, alveolar air concentrations after 35 and 55 minutes of exercise were 196 and 209 ppb, respectively. From this data it would appear that the average proportion of body burden due to dermal exposure after 35 and 55 minutes exercise was 24 and 22%, respectively.

Cammann and Huebner (1995) attempted to correlate chloroform exposure with blood and urine chloroform concentrations in persons using indoor swimming pools. Water and air samples were collected from three pools in Germany, and blood and urine samples were collected from attendants, normal swimmers and agonistic swimmers before and after exposure. Pool water chloroform levels ranged from 3.04 to 27.8  $\mu\text{g/L}$ , while air concentrations ranged from 7.77 to 191  $\mu\text{g/m}^3$ . Blood chloroform levels generally increased with higher chloroform exposure levels. Blood levels were lowest in attendants (0.13-2.45  $\mu\text{g/L}$ ), followed by normal swimmers (0.56-1.65  $\mu\text{g/L}$ ) and agonistic swimmers (1.14-5.23  $\mu\text{g/L}$ ). Based upon the differences seen in the two swimming groups, the authors concluded that increased physical activity leads to increased absorption and/or ingestion. With the exception of the inclusion of attendants, the authors did not attempt to differentiate between inhalation and dermal absorption of chloroform. However, the increased blood concentrations seen in the swimmers seems to indicate that dermal absorption did indeed occur

Dick et al. (1995) examined the absorption of chloroform through human skin *in vivo* using volunteers and *in vitro* using fresh, excised abdominal skin. In the *in vivo* study, the ventral forearm skin of four male volunteers was dosed with a solution of chloroform in either water or ethanol. The solution remained on the skin for eight hours. When administered in water, the total absorbed dose was 8.2%. In contrast, the total absorbed dose was only 1.68% when chloroform was administered in ethanol. In

## 2. HEALTH EFFECTS

the *in vitro* study, two doses were applied to the skin and remained there for four hours. At study termination, the percentages of the low and high doses of chloroform absorbed were 5.6 and 7.1%, respectively.

According to dermal absorption studies with solvents other than chloroform, the absorption of such solvents in guinea pigs is more rapid than the metabolism or pulmonary excretion (Jakobson et al. 1982). A dermal absorption rate of  $329 \text{ nmol/minute/cm}^2$  ( $\pm 60 \text{ nmol/minute/cm}^2$ ) was calculated for the shaved abdominal skin of mice (Tsuruta 1975). This is equivalent to a human absorption rate of  $29.7 \text{ mg/minute}$ , assuming that a pair of hands are immersed in liquid chloroform (Tsuruta 1975). However, this calculation was based on the assumptions that the rate of chloroform penetration is uniform for all kinds of skin and that the total surface area of a pair of human hands is  $800 \text{ cm}^2$ ; the former assumption is especially dubious. Islam et al. (1995) investigated the fate of topically applied chloroform in male hairless rats. For exposures under 4 minutes, chloroform-laden water was applied to shaved back skin; for exposures of 4-30 minutes, rats were submerged in baths containing chloroform-laden water. Selected skin areas were tape-stripped a various number of times after various delay periods. It appeared that there was an incremental build-up of chloroform in the skin over the first four minutes. When compared to uptake measured by bath concentration differences, approximately 88% of lost chloroform was not accounted for in the stratum corneum and was assumed to be systemically absorbed.

### 2.3.2 Distribution

#### 2.3.2.1 Inhalation Exposure

Chloroform is lipid soluble and readily passes through cell membranes, causing narcosis at high concentrations. Blood chloroform concentrations during anesthesia (presumed concentrations 8,000-10,000 ppm) were 7-16.2 mg/mL in 10 patients (Smith et al. 1973). An arterial chloroform concentration of 0.24 mg/mL during anesthesia corresponded to the following partition coefficients: blood/gas, 8; blood/vessel rich compartment, 1.9; blood/muscle compartment, 1.9; blood/fat compartment, 31; blood/vessel poor compartment, 1; and blood/liver, 2 (Feingold and Holaday 1977). Recently, partition coefficients were calculated for humans based on results in mice and rats, and in human tissues *in vitro*: blood/air, 7.4; liver/air, 17; kidney/air, 11; and fat/air, 280 (Corley et al. 1990).

## 2. HEALTH EFFECTS

The chloroform levels in 7 patients who died after excessive administration during anesthesia were: brain, 372-480 mg/kg; lungs, 355-485 mg/kg; and liver, 190-275 mg/kg (Gettler and Blume 1931).

The chloroform levels in patients under anesthesia who died from other causes were: brain, 120-182 mg/kg; lungs, 92-145 mg/kg; and liver, 65-88 mg/kg tissue wet weight. Nashelsky et al. (1995) describe one nonfatal assault and three deaths in which chloroform was utilized. Blood and/or tissue concentrations of chloroform were determined in the assault victim and one decedent within 24 hours, within 10 days in another decedent who was frozen for the majority of that period, and after 5 months without preservation in the last decedent. Blood concentrations in 2 decedents were 2 and 3 µg/mL; fat concentrations were 10 and 42 µg/mL; brain concentrations were 3 and 46 µg/mL; and the liver concentration in one decedent was 24 µg/mL.

After whole-body autoradiography to study the distribution of <sup>14</sup>C-labeled chloroform in mice, most of the radioactivity was found in fat immediately after exposure, while the concentration of radioactivity in the liver increased during the postanesthetic period, most likely due to covalent binding to lipid and protein in the liver (Cohen and Hood 1969). Partition coefficients (tissue/air) for mice and rats were 21.3 and 20.8 for blood; 19.1 and 21.1 for liver; 11 and 11 for kidney; and 242 and 203 for fat, respectively (Corley et al. 1990). Arterial levels of chloroform in mongrel dogs reached 0.35-0.40 mg/mL by the time animals were in deep anesthesia (Chenoweth et al. 1962). Chloroform concentrations in the inhaled stream were not measured, however. After 2.5 hours of deep anesthesia, there were 392 mg/kg chloroform in brain tissue, 1,305 mg/kg in adrenals, 2,820 mg/kg in omental fat, and 290 mg/kg in the liver.

Radioactivity from <sup>14</sup>C-labeled chloroform was detected in the placenta and fetuses of mice shortly after inhalation exposure (Danielsson et al. 1986). In early gestation, accumulation of radioactivity was observed in the embryonic neural tissues, while the respiratory epithelium was more involved in chloroform metabolism in the late fetal period.

Due to its lipophilic character, chloroform accumulates to a greater extent in tissues of high lipid content. As shown by the results presented above, the relative concentrations of chloroform in various tissues decreased as follows: adipose tissue > brain > liver > kidney > blood.

## 2. HEALTH EFFECTS

### 2.3.2.2 Oral Exposure

No studies were located regarding distribution in humans after oral exposure to chloroform.

High concentrations of radioactivity were observed in body fat and livers of rats, mice, and squirrel monkeys given oral doses of 60 mg/kg <sup>14</sup>C-labeled chloroform (Brown et al. 1974a). The maximum levels of radioactivity in the blood appeared within 1 hour and were 3 µg equivalents chloroform/ml for mice and 10 µg equivalents chloroform/ml for monkeys, which represented ≈0.35 and 1%, respectively, of the total radioactivity. In monkeys, bile concentrations peaked within 6 hours. The distribution of radioactively labeled chloroform was studied in three strains of mice (Taylor et al. 1974). No strain-related differences were observed; however, higher levels of radioactivity were found in the renal cortex of males and in the liver of females. The renal binding of radioactive metabolites may have been altered by variations in the testosterone levels as a result of hormonal pretreatment in females or castration in males. Sex-linked differences in chloroform distribution were not observed in rats or monkeys (Brown et al. 1974a). Chloroform accumulates in the adipose tissue of rats after oral exposure of intermediate duration (Pfaffenberger et al. 1980).

### 2.3.2.3 Dermal Exposure

A limited number of studies were located regarding distribution in humans or animals after dermal exposure to chloroform.

Dick et al. (1995) examined the absorption of chloroform through human skin *in vivo* using volunteers and *in vitro* using fresh, excised abdominal skin. In the *in vivo* study, the ventral forearm skin of four male volunteers was dosed with a solution of chloroform in either water or ethanol. The solution remained on the skin for eight hours. When administered in water, urinary excretion was 0.42%, while excretion from the lungs over the first 48 hours postexposure averaged 7.8%. Tape-stripping data indicated that only 0.01% of the dose remained in the skin after 3 days. When chloroform was administered in ethanol, urinary excretion was 0.07% while excretion from the lungs over the first 48 hours postexposure averaged 0.83%. Tape-stripping data indicated that the percentage of the dose remaining in the skin after three days was non detectable. In the *in vitro* study, two doses were applied to the skin and remained there for four hours. At study termination, the majority of the

## 2. HEALTH EFFECTS

absorbed dose was found in the perfusate (7.0%), with only minor amounts remaining in the skin (0.14%).

Islam et al. (1995) investigated the fate of topically applied chloroform in male hairless rats. For exposures under 4 minutes, chloroform-laden water was applied to shaved back skin; for exposures of 4-30 minutes, rats were submerged in baths containing chloroform-laden water. Selected skin areas were tape-stripped a various number of times after various delay periods. The authors found that the accumulated amount of chloroform declined rapidly with depth of stratum corneum. As the time of exposure decreased, smaller amounts of chloroform were found in the deeper layers of stratum comeum; by five minutes postexposure, the amount of chloroform at the first tape strip (skin surface) dropped to negligible levels. It appeared that there was an incremental build-up of chloroform in the skin over the first four minutes. When compared to uptake measured by bath concentration differences, approximately 88% of the chloroform dose was not accounted for in the stratum comeum and was assumed to be systemically absorbed.

### 2.3.3 Metabolism

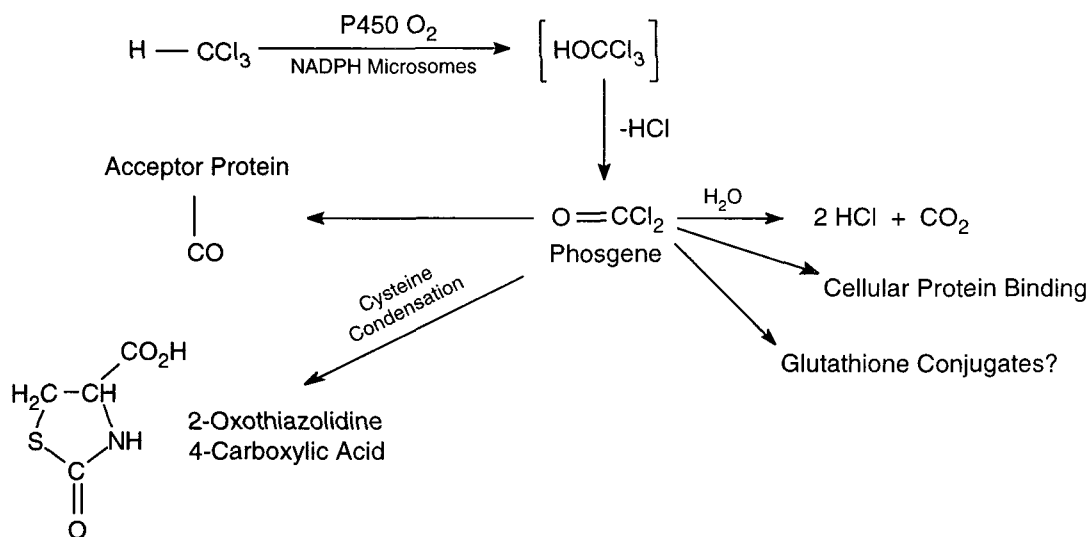
The metabolism of chloroform is well understood. Approximately 50% of an oral dose of 0.5 grams of chloroform was metabolized to carbon dioxide in humans (Fry et al. 1972). Metabolism was dose-dependent, decreasing with higher exposure. A first-pass effect was observed after oral exposure (Chiou 1975). Approximately 38% of the dose was converted in the liver, and  $\leq 17\%$  was exhaled unchanged from the lungs before reaching the systemic circulation. On the basis of pharmacokinetic results obtained in rats and mice exposed to chloroform by inhalation, and of enzymatic studies in human tissues *in vitro*, *in vivo* metabolic rate constants ( $V_{\max}C = 15.7$  mg/hour/kg,  $K_m = 0.448$  mg/L) were defined for humans (Corley et al. 1990). The metabolic activation of chloroform to its toxic intermediate, phosgene, was slower in humans than in rodents.

Metabolic pathways of chloroform biotransformation are shown in Figure 2-3. Metabolism studies indicated that chloroform was, in part, exhaled from the lungs or was converted by oxidative dehydrochlorination of its carbon-hydrogen bond to form phosgene (Pohl et al. 1981; Stevens and Anders 1981). This reaction was mediated by cytochrome P-450 and was observed in the liver and kidneys (Ade et al. 1994; Branchflower et al. 1984; Smith et al. 1984). In renal cortex microsomes of

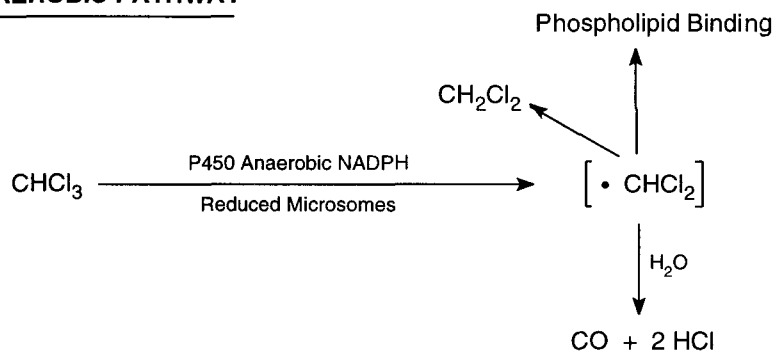
2. HEALTH EFFECTS

**Figure 2-3. Metabolic Pathways of Chloroform Biotransformation**

**MAJOR AEROBIC PATHWAY**



**MINOR ANAEROBIC PATHWAY**





## 2. HEALTH EFFECTS

DBA/2J mice, the majority of chloroform metabolism was oxidative under ambient oxygen conditions, while anoxic conditions resulted in reductive metabolism (Ade et al. 1994). Phosgene may react with two molecules of GSH to form diglutathionyl dithiocarbonate, which is further metabolized in the kidneys, or it may react with other cellular elements and induce cytotoxicity (Pohl and Gillette 1984). *In vitro* studies indicate that phosgene and other reactive chloroform metabolites bind to lipids and proteins of the endoplasmic reticulum proximate to the cytochrome P-450 (Sipes et al. 1977; Wolf et al. 1977). The metabolism of chloroform to reactive metabolites occurs not only in microsomes but also in nuclear preparations (Gomez and Castro 1980). Covalent binding of chloroform to lipids can occur under anaerobic and aerobic conditions, while binding to the protein occurs only under aerobic conditions (Testai et al. 1987). It was further demonstrated that chloroform can induce lipid peroxidation and inactivation of cytochrome P-450 in rat liver microsomes under anaerobic conditions (De Groot and No11 1989). Covalent binding of chloroform metabolites to microsomal protein *in vitro* was intensified by microsomal enzyme inducers and prevented by GSH (Brown et al. 1974b). It was proposed that the reaction of chloroform metabolites with GSH may act as a detoxifying mechanism. When GSH is depleted, however, the metabolites react with microsomal protein, and may cause necrosis. This is supported by observations that chloroform doses that caused liver GSH depletion produced liver necrosis (Docks and Krishna 1976). In fasted animals, chloroform has been found to be more hepatotoxic (Brown et al. 1974b; Docks and Krishna 1976) even though animals were found to have lower blood chloroform concentrations (Wang et al. 1995); this phenomenon would apparently be explained by a decreased GSH content and resultant inability to bind toxic metabolites. This may explain the clinical finding of severe acute hepatotoxicity in women exposed to chloroform via anesthesia during prolonged parturition. Evidence that chloroform is metabolized at its carbonhydrogen bond is provided by experiments using the deuterated derivative of chloroform (Branchflower et al. 1984; McCarty et al. 1979; Pohl et al. 1980a). Deuterated chloroform was one-half to one-third as cytotoxic as chloroform, and its conversion to phosgene was much slower. The results confirmed that the toxicity of chloroform is primarily due to its metabolites.

A recent *in vitro* study of mice hepatic microsomes indicated that a reductive pathway may also play an important role in chloroform hepatotoxicity (Testai et al. 1990). It was demonstrated that radical chloroform metabolites bind to macromolecules (proteins, lipids) and the process can be inhibited by reduced GSH.

## 2. HEALTH EFFECTS

The final product of the aerobic metabolic pathway of chloroform is carbon dioxide (Brown et al. 1974a; Fry et al. 1972). This carbon dioxide is mostly eliminated through the lungs, but some is incorporated into endogenous metabolites and excreted as bicarbonate, urea, methionine, and other amino acids (Brown et al. 1974a). Chloride ions are an end product of chloroform metabolism found in the urine (Van Dyke et al. 1964). Carbon monoxide was a minor product of the anaerobic metabolism of chloroform *in vitro* (Ahmed et al. 1977) and *in vivo* in rats (Anders et al. 1978).

A sex-related difference in chloroform metabolism was observed in mice (Taylor et al. 1974). Chloroform accumulated and metabolized in the renal cortex of males to a greater extent than in females, while liver chloroform concentrations were greater in females than in males; the results may have been influenced by testosterone levels. This effect was not observed in any other species and may explain why male mice were more susceptible to the lethal and renal effects of chloroform than were females (Deringer et al. 1953).

Wang et al. (1994) found that, in male Wistar rats, pretreatment with ethanol increased chloroform metabolism about 1.5-fold but did not affect hepatic microsomal protein or cytochrome P-450 content. In addition, intraperitoneal administration of chloroform resulted in greater blood concentrations, peak values, and area of the curves (AUCs), as compared to oral administration. AUCs in rats administered chloroform orally ranged from 0.34 to 6.45 versus 0.58 to 8.78 in rats administered chloroform intraperitoneally. The authors concluded that differences between route groups in hepatotoxicity were due to differences in the proportion of dose exposed to first-pass metabolism. Since oral dosing results in the greatest first-pass exposure, this route resulted in the greatest hepatotoxicity. The degree of hepatic exposure also influenced the enhancing effect of ethanol; the group receiving chloroform orally was affected the most by ethanol pretreatment. The authors also concluded that intraperitoneal exposure produced data which most like that of inhalation exposure, presumably due to the smaller proportion of dose going through first-pass metabolism.

Interspecies differences in the rate of chloroform conversion were observed in mice, rats, and squirrel monkeys, with species differences in metabolism being highly dose-dependant. The conversion of chloroform to carbon dioxide was highest in mice (80%) and lowest in squirrel monkeys (18%) (Brown et al. 1974a). Similarly, chloroform metabolism was calculated to be slower in humans than in rodents. Therefore, it was estimated that the exposure to equivalent concentrations of chloroform would lead to a much lower delivered dose in humans (Corley et al. 1990).

## 2. HEALTH EFFECTS

A study by Gearhart et al. (1993) was conducted to determine the interactions of chloroform exposure with body temperature, gas uptake, and tissue solubility in mice as possible explanations for the difficulty in fitting a physiologically based pharmacokinetic/pharmacodynamic (PBPK) model to chloroform gas-uptake data to derive *in vivo* metabolic constants. Male mice were exposed to air concentrations of 100, 800, 2,000, or 5,500 ppm chloroform for 6 hours and their core body temperatures monitored frequently over the exposure period. After exposure, blood, liver, thigh muscle, and fat tissues were removed for tissue/air and tissue/blood partition coefficient analysis at 3 temperatures (25, 31, and 37 °C). For all tissues, tissue/air partition coefficients exhibited temperature-dependent decreases with increasing temperature. The rate of decrease was greatest for the blood/air partition coefficient. Average body temperatures for each exposure group decreased as the exposure concentrations increased. Temperature dependent decreases in core body temperature were hypothesized to decrease overall metabolism of chloroform in mice. The data collected were also used to develop a PBPK model for chloroform disposition.

### 2.3.4 Elimination and Excretion

#### 2.3.4.1 Inhalation Exposure

Chloroform was detected in the exhaled air of volunteers exposed to a normal environment, to heavy automobile traffic, or to air in a dry cleaning establishment (Gordon et al. 1988). Higher chloroform levels in the breath corresponded to higher exposure levels. The calculated biological half-time for chloroform was 7.9 hours.

Excretion of radioactivity in mice and rats was monitored for 48 hours following exposure to <sup>14</sup>C-labeled chloroform (Corley et al. 1990). In general, 92-99% of the total radioactivity was recovered in mice, and 58-98% was recovered in rats; percentage of recovery decreased with increasing exposure. With increasing concentration, mice exhaled 80-85% of the total radioactivity recovered as <sup>14</sup>C-labeled carbon dioxide, 0.4-8% as <sup>14</sup>C-labeled chloroform, and 8-11 and 0.6-1.4% as urinary and fecal metabolites, respectively. Rats exhaled 48-85% of the total radioactivity as <sup>14</sup>C-labeled carbon dioxide, 2-42% as <sup>14</sup>C-labeled chloroform, and 8-11 and 0.1-0.6% in the urine and feces, respectively. A 4-fold increase in exposure concentration was followed by a 50- and 20-fold increase in the amount of exhaled, unmetabolized chloroform in mice and rats, respectively.

## 2. HEALTH EFFECTS

### 2.3.4.2 Oral Exposure

Following a single, oral exposure, most of the 0.5 grams of radioactively labeled chloroform administered to volunteers was exhaled during the first 8 hours after exposure (Fry et al. 1972). A slower rate of pulmonary excretion was observed during the first eight hours in volunteers who had more adipose tissue than the other volunteers. Up to 68.3% of the dose was excreted unchanged, and up to 50.6% was excreted as carbon dioxide. A positive correlation was made between pulmonary excretion and blood concentration. Less than 1% of the radioactivity was detected in the urine.

Approximately 80% of a single dose of 60 mg/kg  $^{14}\text{C}$ -labeled chloroform was converted within 24 hours to  $^{14}\text{C}$ -labeled carbon dioxide in mice (Brown et al. 1974a; Taylor et al. 1974), while only  $\approx 66\%$  of the dose was converted to  $^{14}\text{C}$ -labeled carbon dioxide in rats (Brown et al. 1974a).

Eight hours after administration of 100-150 mg/kg of  $^{14}\text{C}$ -labeled chloroform, 49.6 and 6.5% of radioactivity was converted to carbon dioxide, 26.1 and 64.8% was expired as unmetabolized parent compound, and 4.9 and 3.6% was detected in the urine in mice and rats, respectively (Mink et al. 1986). These results indicate that mice metabolize high doses of chloroform to a greater degree than rats do. Only 18% of a chloroform dose was metabolized to  $^{14}\text{C}$ -labeled carbon dioxide in monkeys, and  $\approx 79\%$  was detected as unchanged parent compound or toluene soluble metabolites (Brown et al. 1974a). Within 48 hours after exposure,  $\approx 2$ , 8, and 3% of the administered radioactivity was detected in the urine and feces of monkeys, rats, and mice, respectively.

### 2.3.4.3 Dermal Exposure

One study was located regarding excretion in humans after dermal exposure to chloroform. Dick et al. (1995) examined the fate of chloroform applied to human skin *in vivo* using volunteers and *in vitro* using fresh, excised abdominal skin. In the *in vivo* study, the ventral forearm skin of four male volunteers was dosed with a solution of chloroform in either water or ethanol. The solution remained on the skin for eight hours. When administered in water, urinary excretion was 0.42%, while excretion from the lungs over the first 48 hours postexposure averaged 7.8%. Tape-stripping data indicated that only 0.01% of the dose remained in the skin after three days. When chloroform was administered in ethanol, urinary excretion was 0.07% while excretion from the lungs over the first 48 hours postexposure averaged 0.83%. Tape-stripping data indicated that the percentage of the dose remaining in the skin after three days was non detectable. In the *in vitro* study, two doses were

## 2. HEALTH EFFECTS

applied to the skin and remained there for four hours. At study termination, the majority of the absorbed dose was found in the perfusate (7%), with only minor amounts remaining in the skin (0.14%).

No animal studies were located regarding the excretion of chloroform after dermal exposure to chloroform.

### **2.3.5 Physiologically Based Pharmacokinetic (PBPK)/Pharmacodynamic (PD) Models**

Physiologically based pharmacokinetic (PBPK) models use mathematical descriptions of the uptake and disposition of chemical substances to quantitatively describe the relationships among critical biological processes (Krishnan et al. 1994). PBPK models are also called biologically based tissue dosimetry models. PBPK models are increasingly used in risk assessments, primarily to predict the concentration of potentially toxic moieties of a chemical that will be delivered to any given target tissue following various combinations of route, dose level, and test species (Clewell and Andersen 1985). Physiologically based pharmacodynamic (PBPD) models use mathematical descriptions of the dose-response function to quantitatively describe the relationship between target tissue dose and toxic end points.

PBPK/PD models refine our understanding of complex quantitative dose behaviors by helping to delineate and characterize the relationships between: (1) the external/exposure concentration and target tissue dose of the toxic moiety, and (2) the target tissue dose and observed responses (Andersen et al. 1987; Andersen and Krishnan 1994). These models are biologically and mechanistically based and can be used to extrapolate the pharmacokinetic behavior of chemical substances from high to low dose, from route to route, between species, and between subpopulations within a species. The biological basis of PBPK models results in more meaningful extrapolations than those generated with the more conventional use of uncertainty factors.

The PBPK model for a chemical substance is developed in four interconnected steps: model representation, model parameterization, model simulation, and (4) model validation (Krishnan and Andersen 1994). In the early 1990s, validated PBPK models were developed for a number of toxicologically important chemical substances, both volatile and nonvolatile (Krishnan and Andersen 1994; Leung 1993). PBPK models for a particular chemical substance require estimates of the

## 2. HEALTH EFFECTS

chemical substance-specific physicochemical parameters, and species-specific physiological and biological parameters. The numerical estimates of these model parameters are incorporated within a set of differential and algebraic equations that describe the pharmacokinetic processes. Solving these differential and algebraic equations provides the predictions of tissue dose. Computers then provide process simulations based on these solutions.

The structure and mathematical expressions used in PBPK models significantly simplify the true complexities of biological systems. This simplification, however, is desirable if the uptake and disposition of the chemical substance(s) is adequately described because data are often unavailable for many biological processes and using a simplified scheme reduces the magnitude of cumulative uncertainty. The adequacy of the model is therefore of great importance and thus model validation must be critically considered.

PBPK models improve the pharmacokinetic extrapolation aspects of the risk assessment process, which seeks to identify the maximal (i.e., safe) levels for human exposure to chemical substances (Andersen and Krishnan 1994). PBPK models provide a scientifically sound means to predict the target tissue dose of chemicals in humans who are exposed to environmental levels (for example, levels that might occur at hazardous waste sites) based upon the results of studies where doses were higher or were administered in different species. Figure 2-4 shows a conceptualized representation of a PBPK model.

If PBPK models for chloroform exist, the overall results and individual models are discussed in this section in terms of their use in risk assessment, tissue dosimetry, and dose, route, and species extrapolations.

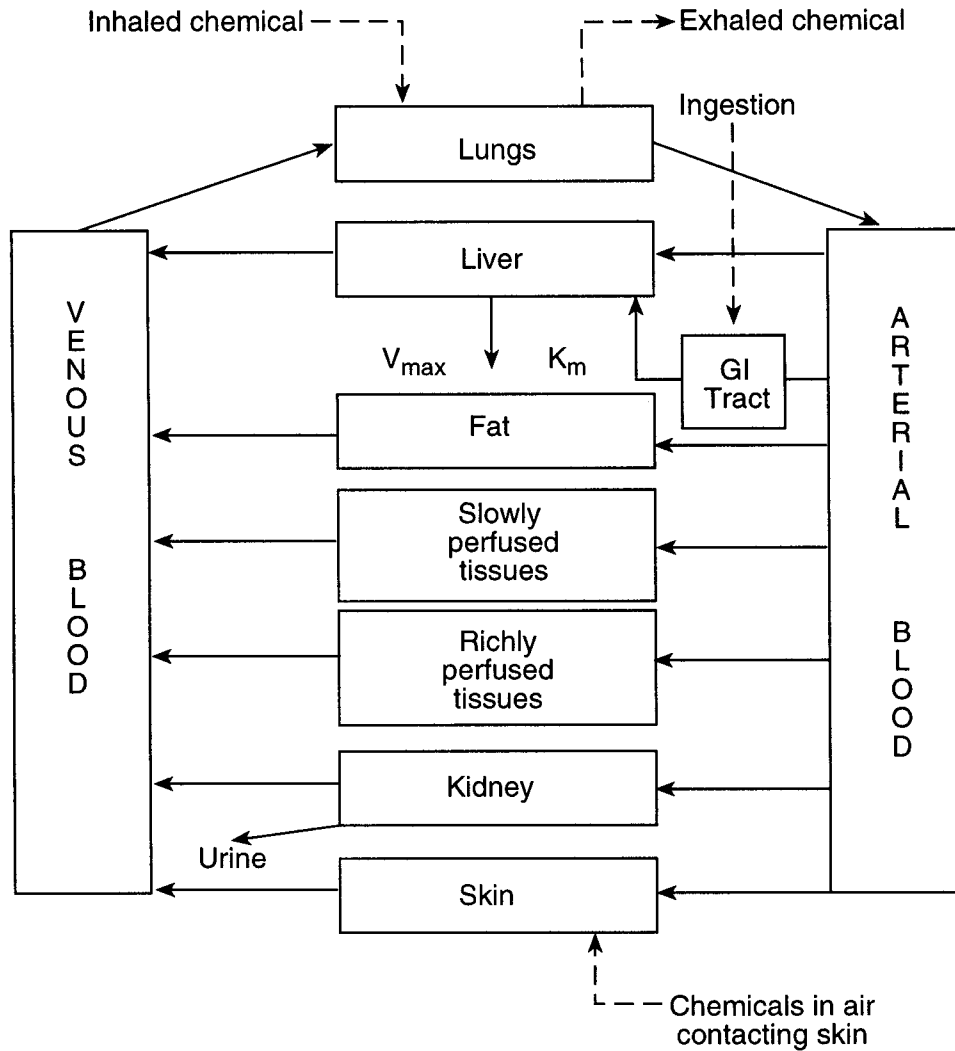
### **2.3.5.1 Summary of PBPK/PD Models**

Several rodent and human models have been used to predict the absorption (oral, inhalation, and dermal) from water and air, distribution, metabolism, and excretion of chloroform.

In a PBPK model that used simulations with mice, rats, and humans (Corley et al. 1990), the tissue delivered dose from equivalent concentrations of chloroform was highest in the mouse, followed by rats and then humans. The authors suggest that this behavior is predicted by the model because of the lower relative rates of metabolism, ventilation, and cardiac output (per kg of body weight) in the

## 2. HEALTH EFFECTS

**Figure 2-4. Conceptual Representation of a Physiologically Based Pharmacokinetic (PBPK) Model for a Hypothetical Chemical Substance**



Source: adapted from Krishnan et al. 1992

Note: This is a conceptual representation of a physiologically based pharmacokinetic (PBPK) model for a hypothetical chemical substance. The chemical substance is shown to be absorbed via the skin, by inhalation, or by ingestion, metabolized in the liver, and excreted in the urine or by exhalation.

## 2. HEALTH EFFECTS

larger species. Assuming that equivalent target doses produce equivalent toxicities in target tissues, the relative sensitivities of the three species used in the study (mouse > rat > human) predicted by the model under identical exposure conditions are quite different from the relative sensitivity to chloroform assumed by the “uncertainty factor.”

In a PBPK/PD model based closely on the Corley model, Reitz et al. (1990) described a pharmacodynamic end point (cytotoxicity) in the livers of chloroform-exposed animals produced by phosgene, the reactive metabolite of chloroform.

In gas-uptake experiments, Gearhart et al. (1993) demonstrated a dose-dependent decrease in core body temperature with increased inhaled concentrations of chloroform. The decrease in body temperature could account for decreased *in vivo* chloroform metabolism, partition coefficients, pulmonary ventilation, and cardiac output rates in mice.

Chinery and Gleason (1993) used a shower model for chloroform-contaminated water to predict breath concentration (as a quantifiable function of tissue dose) and actual absorbed dose from a measured water supply concentration following exposure while showering. The model's predictions demonstrated that dose information based only on dermal absorption (without considering an inhalation component) may underestimate actual dose to target organs in dosimetric assessment for chloroform in water supplies during shower. The model also predicted a steady-state *stratum corneum* permeability of chloroform in human skin in the range of 0.16-3.6 cm/hour with the most likely value being 0.2 cm/hour. The authors suggest that the results predicted by this model could be used to estimate household exposures to chloroform or other exposures which include dermal absorption.

McKone (1993) demonstrated that chloroform in shower water had an average effective dermal permeability between 0.16 and 0.42 cm/hour for a 10-minute shower. The model predicted that the ratio of chloroform dermally absorbed in the shower (relative to chloroform-contaminated water concentration) ranged between 0.25 and 0.66 mg per mg/L. In addition, the McKone model demonstrated that chloroform metabolism by the liver was not linear across all dermal/inhalation exposure concentrations and became nonlinear at higher (60-100 mg/L) dose concentrations.



## 2. HEALTH EFFECTS

### 2.3.5.2 Chloroform PBPK Model Comparison

Five chloroform PBPK models that describe the disposition of chloroform in animals and humans have been identified from the recent open literature (early 1980s-1994). Based on the information presented in these five models, there appears to be sufficient evidence to suggest that PBPK models for chloroform are fairly refined and have a strong potential for use in human risk assessments. The PBPK model developed by Corley et al. (1990) has provided a basic model for the fate of chloroform in humans and laboratory animals. Using this model as a template, other more sophisticated and refined models have been developed that can be used in human risk assessment work. The models of Corley et al. (1990) and Reitz et al. (1990) have described several aspects of chloroform metabolism and disposition in laboratory animals and humans; however, they do not address the dermal routes of exposure. The models of McKone (1993) and Chinery and Gleason (1993) address both the inhalation and dermal exposure routes in humans the Chinery and Gleason model uses a 3-compartment skin component which may more accurately reflect the flux of chloroform through the skin after dermal only or dermal plus inhalation exposure scenarios, while the McKone model uses a single compartment within the skin to describe chloroform flux. Further discussion of each model and its application in human risk assessments is presented below.

### 2.3.5.3 Discussion of Chloroform Models

#### The Corley Model

The Corley model (Corley et al. 1990) was the first chloroform PBPK model to describe and ultimately predict the fate of chloroform in several species (including humans) under a variety of exposure conditions. Many subsequent PBPK models for chloroform (Chinery and Gleason 1993; McKone 1993) are based on the Corley model. The Corley model has been used for cancer risk assessment (Reitz et al. 1990).

**Risk Assessment.** This model successfully described the disposition of chloroform in rats, mice and humans following various exposure scenarios and developed dose surrogates more closely related to toxicity response. With regard to target tissue dosimetry, the Corley model predicts the relative order of susceptibility to chloroform toxicity consequent to binding to macromolecules (MMB) to be mouse > rat > human. Linking the pharmacokinetic parameters of this model to the pharmacodynamic

## 2. HEALTH EFFECTS

cancer model of Reitz et al. (1990) provides a biologically based risk assessment model for chloroform.

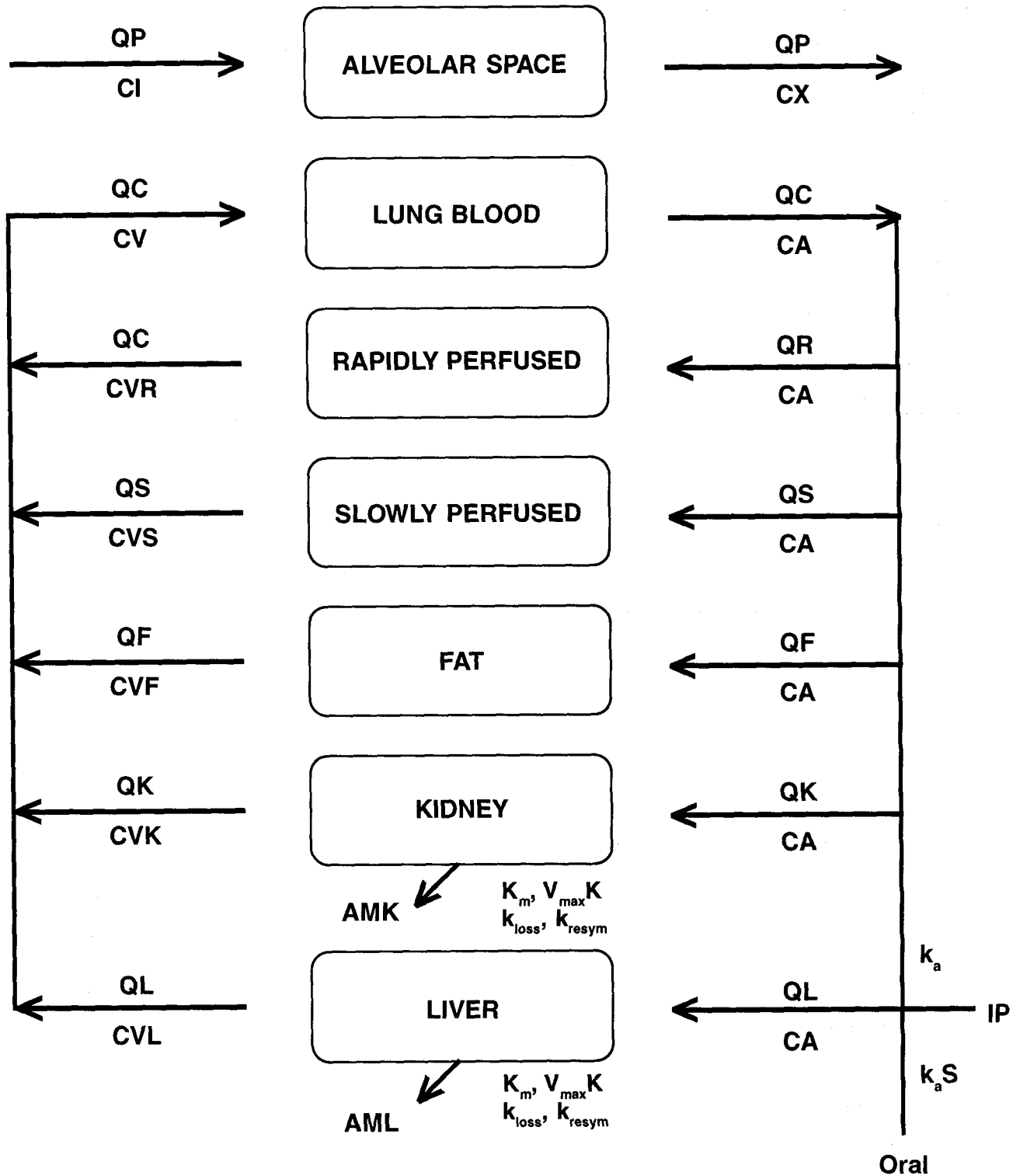
**Description of the Model.** The Corley chloroform PBPK model was based on an earlier PBPK model developed by Ramsey and Andersen (1984) to describe the disposition of styrene exposure in rats, mice, and humans. A schematic representation of the Corley model (taken from Corley et al. 1990) is shown in Figure 2-5 with oral, inhalation, and intraperitoneal routes represented. The dermal route of exposure is not represented in this model; however, others have modified the Corley model to include this route of exposure (see below). Liver and kidney are represented as separate compartments since both are target organs for chloroform.

The physiologic, biochemical constants and partition coefficients required for the model are shown in Table 2-4. Physiologic constants (organ weight, blood flows, etc) were similar to those used by Andersen et al. (1987) or were taken from other literature sources. Tissue and blood partition coefficients were determined in tissues by vial equilibration techniques in the rat and human, with extrapolated values used for the mouse. All metabolism of chloroform was assumed to occur only in the liver and kidneys through a single metabolic pathway (mixed function oxidase) that followed simple Michaelis-Menten kinetic parameters. Metabolic rate constants were obtained from the gasuptake experiments. Human metabolic rate constants were obtained from *in vitro* human microsomal fractions of liver and kidney samples using  $^{14}\text{CCHCl}_3$  as the substrate. Binding of chloroform metabolites (phosgene) to MMBs was assumed to occur in bioactivating tissues (liver and kidney) in a non-enzymatic, nonspecific, and dose-independent fashion. Macromolecular binding constants for the liver and kidney were estimated from *in vivo* MMB data obtained from rats and mice exposed to  $^{14}\text{CCHCl}_3$  via inhalation.

The gas-uptake data for rats were well described using a single Michaelis-Menten equation to describe metabolism. For the mouse inhalation studies, a simple Michaelis-Menten equation failed to adequately describe the chloroform-metabolizing capacity based on the data collected and model constants. The authors suspected that, following the administration of chloroform (particularly at higher concentrations), destruction of microsomal enzymes and subsequent resynthesis of microsomal enzymes was important in the mouse. This phenomenon has been documented in phenobarbital-induced but not naive rats. To account for this phenomenon, a first-order rate constant for the loss and subsequent regeneration of metabolic capacity was incorporated into the model for mice only.

2. PUBLIC HEALTH

Figure 2-5. Parameters Used in the Corley PBPK Model



Physiological model used to describe the pharmacokinetics of chloroform in rats, mice, and humans during inhalation, oral, and intraperitoneal exposures.

AMK = amount metabolized in kidney; AML = amount metabolized in liver

## 2. HEALTH EFFECTS

Table 2-4. Parameters Used in the Corley PBPK Model

Parameters	Mouse	Rat	Human
	<i>Weights (kg):</i>		
Body	0.02858	0.230	70.0
	<i>Percentage of Body Weight</i>		
Liver	5.86	2.53	3.14
Kidney	1.70	0.71	0.44
Fat	6.00	6.30	23.10
Rapidly perfused tissues	3.30	4.39	3.27
Slowly perfused tissues	74.14	77.07	61.05
	<i>Flows (L/hr/kg)</i>		
Alveolar ventilation	2.01	5.06	347.9
Cardiac output	2.01	5.06	347.9
	<i>Percentage of Cardiac Output</i>		
Liver	25.0	25.0	25.0
Kidney	25.0	25.0	25.0
Fat	2.0	5.0	5.0
Rapidly perfused tissues	29.0	26.0	26.0
Slowly perfused tissues	19.0	19.0	19.0
	<i>Partition Coefficients</i>		
Blood/air	21.3	20.8	7.43
Liver/air	19.1	21.1	17.00
Kidney/air	11.0	11.0	11.00
Fat/air	242.0	203.0	280.00
Rapidly perfused/air	19.1	21.1	17.0
Slowly perfused/air	13.0	13.9	12.0
	<i>Metabolic and macromolecular binding constants</i>		
$V_{\max}$ C (mg/hr/kg)	22.8	6.8	15.7
$K_m$ (mg/L)	0.352	0.543	0.448
$K_{\text{loss}}$ (l/mg)	$5.72 \times 10^{-4}$	0	0
$K_{\text{resyn}}$ ( $\text{hr}^{-1}$ )	0.125	0	0
A (kidney/liver)	0.153	0.052	0.033
fMMB ( $\text{hr}^{-1}$ ), liver	0.003	0.00104	0.00202
fMMB ( $\text{hr}^{-1}$ ), kidney	0.010	0.0086	0.00931
	<i>Gavage Absorption Rate Constants</i>		
$k_{aS}$ ( $\text{hr}^{-1}$ ), corn oil	0.6	0.6	0.6
$k_{aS}$ ( $\text{hr}^{-1}$ ), water	5.0	5.0	5.0
	<i>Intraperitoneal Injection Absorption Rate Constant</i>		
$k_a$ ( $\text{hr}^{-1}$ )	1.0	1.0	1.0

## 2. HEALTH EFFECTS

The model also provided a good description of the *in vivo* levels of MMB in both rats and mice, with good agreement between observed and predicted values.

**Validation of the Model.** The Corley model was validated using chloroform data sets from oral (Brown et al. 1974a) and intraperitoneal (Ilett et al. 1973) routes of administration and from human pharmacokinetic studies (Fry et al. 1972). Metabolic rate constants obtained from the gas-uptake experiments were validated by modeling the disposition of radiolabeled chloroform in mice and rats following inhalation of chloroform at much lower doses. For the oral data set, the model accurately predicted the total amounts of chloroform metabolized for both rats and mice.

**Target Tissues.** The model provided excellent predictions of MMB in both the target tissues of chloroform (liver and kidney) after intraperitoneal administration in mice (rat data was not generated). The model adequately predicted the amount of unchanged material exhaled at infinite time and the total amount metabolized by groups of male and female humans of widely varying age and weight.

**Species Extrapolation.** The Corley model used species-specific information to outline the model parameters; little extrapolation of information among mice, rats and humans was required. Certain parameters previously reported in the scientific literature were assumed, however, such as body weight, percentage of body weight, and percentage of blood from the heart (i.e., percentage of cardiac output of body organs, see Table 2-4).

**High-low Dose Extrapolation.** The Corley model was designed to facilitate extrapolations from high doses (similar to those used for chronic rodent studies) to low doses that humans may potentially be exposed to at home or in the workplace.

**Interroute Extrapolation.** The Corley model used three routes of administration, intraperitoneal, oral and inhalation, in rats and mice to describe the disposition of chloroform. This data was validated for humans by comparing the model output using the animal data with actual human data from human oral chloroform pharmacokinetic studies. Using the human pharmacokinetic constants from the *in vitro* studies conducted by Corley, the model made adequate predictions of the amount of chloroform metabolized and exhaled in both males and females.

## 2. HEALTH EFFECTS

### The Reitz Model

**Risk Assessment.** The Reitz model is based on the assumption that cytotoxicity and reparative hyperplasia are responsible for liver neoplasia. Dose-surrogates, a more sophisticated and more accurate measure of target tissue dose derived from measuring a pharmacodynamic effect, were used.

**Description of the Model.** The Reitz PBPK model was largely based on the Corley et al. (1990) model, but differed in the use of a pharmacodynamic end point, cytotoxicity in the livers of chloroform-exposed animals (mice) produced by phosgene (the reactive metabolite of chloroform). The Reitz model focused on the liver as the target organ for chloroform, hence the kidney compartment toxicity was not addressed. The kidney compartment was combined with the rapidly perfused tissue group. The Reitz model used two types of dose measurement, referred to as dose surrogates. One type of dose surrogate used was covalent binding to MMBs (average daily macromolecular binding, AVEMMB), a rate independent parameter. The second type of dose surrogate was cytotoxicity (PTDEAD), a rate dependent parameter that measured cell death (by histopathological analysis and  $^3\text{H}$ thymidine uptake) due to the formation of reactive chloroform metabolites (i.e., phosgene). Model calculations of PTDEAD were based on several assumptions: that liver cells have a finite capability for repairing damage caused by  $\text{CHCl}_3$  metabolites; that liver cells differ from cell to cell in their capabilities to repair this damage; and that induction of cytotoxicity in liver cells does not occur instantaneously.

**Validation of the Model.** The model simulations of PTDEAD were compared with two experimental measures of cytotoxicity: the percentage of nonviable cells observed microscopically in mice gavaged with solutions of chloroform in corn oil, and the rate of incorporation of  $^3\text{H}$ thymidine into normal DNA during compensatory cell replication (CCR). CCR was measured following exposure of mice to chloroform vapor for 5-6 hours. Model predictions were in good agreement (within 10%) with observed percentages of dead liver cells evaluated microscopically. Agreement between predicted and observed values of cell killing based on CCR was less satisfactory.

**Target Tissues.** The Reitz model only applies to the metabolism of chloroform and the induction of cytotoxicity in liver tissue following exposure by inhalation, drinking water, and gavage routes using rat and mouse data.

## 2. HEALTH EFFECTS

**Species Extrapolation.** The Reitz model used the same species and physiologic parameters that the Corley model utilized (average body weights, organ percentage of body weight, blood flow, etc.) for model predictions. See Table 2-4 for these parameters. However, the model assumed equivalent intrinsic sensitivity of mouse and human hepatocytes.

**High-low Dose Extrapolation.** The Reitz model was designed to facilitate extrapolations from high doses (similar to those used for chronic rodent studies) to low doses that humans may potentially be exposed to at home or in the workplace.

**Interroute Extrapolation.** Inhalation and oral routes of administration were examined in the Reitz model; however, interroute extrapolations were not specifically addressed in the Reitz model.

### The Gearhart Model

**Risk Assessment.** The Gearhart model provided strong evidence that temperature changes play an important role in predicting chloroform metabolism in mice and also provided a testable hypothesis for the lack of fit of the Corley model prediction with respect to the mouse data. These data strengthen the Corley model and its implications for human risk assessment (see the Corley model description above).

**Description of the Model.** Gearhart et al. (1993) developed a PBPK model that described the effects of decreased core body temperature on the analysis of chloroform metabolic data. Experimental data showed that when male B6C3F<sub>1</sub> mice were exposed for 6 hours to chloroform vapor concentrations of 100-5,500 ppm, a dose-dependent drop in core body temperature occurred, with the least amount of temperature drop occurring at the 100 ppm concentration and the most dramatic drop in temperature occurring at the 5,500 ppm level. The Gearhart model incorporated a model previously used by Ramsey and Andersen (1984) (the same model and parameters the Corley model was based on) in conjunction with a separate model reflecting changes in body core temperature to drive equations accounting for changes in partition coefficients, cardiac output, minute ventilation volumes, and rate of chloroform metabolism.

The model predicted that the  $V_{\max}$  for chloroform metabolism without correcting for core temperature effects was 14.2 mg/hour/kg (2/3 of that reported in the Corley model) and the  $K_m$  was 0.25 mg/L.

## 2. HEALTH EFFECTS

Without body temperature corrections, the model underpredicted the rate of metabolism at the 5,500 ppm vapor concentration. Addition of a first-order kinetic rate constant ( $k_f=1.86 \text{ hour}^{-1}$ ) to account for liver metabolism of chloroform at high doses of chloroform did provide a small improvement in model predictions at 5,500 ppm, but was still considered inadequate for predicting metabolism at high concentrations.

**Validation of the Model.** The Gearhart model was not validated against a comparable data set. Corrections for the temperature effects ( $V_{\max}$  increased to 15.1 mg/hour/kg) and inclusion of a firstorder metabolism correction equation provided an accurate prediction of chloroform metabolism across all concentrations tested.

**Target Tissues.** The liver was the target tissue for this model.

**Species Extrapolation.** No species extrapolation was specifically addressed by the Gearhart model.

**High-low Dose Extrapolation.** No high-low dose extrapolation was specifically addressed by the Gearhart model.

**Interroute Extrapolation.** No interrout extrapolation was specifically addressed by the Gearhart model.

### **The Chinery-Gleason Model**

**Risk Assessment.** The Chinery-Gleason model has the greatest potential for use in estimating exposures to chloroform in a household environment as well as for occupational exposures that result from dermal exposure.

**Description of the Model.** The Chinery and Gleason (1993) PBPK model is a combination of the Corley et al. (1990) model and other existing models that includes a multicompartment skin component similar to that of Shatkin and Szejnwald-Brown (1991). This compartment is used to simulate penetration of chloroform into the skin while showering for 10 minutes with water containing chloroform. The skin module for this new model assumed a physiologic skin compartment consisting



## 2. HEALTH EFFECTS

of three linear compartments: the dilute aqueous solution compartment; the stratum corneum (the primary barrier to the absorption of most chemicals, including chloroform); and the viable epidermis.

**Validation of the Model.** The model was validated using published data and experimentally derived exhaled breath concentrations of chloroform following exposure in a shower stall (Jo et al. 1990a).

**Target Tissues.** Based on the data set of Jo et al. (1990a), the Chinery-Gleason model predicted the stratum corneum permeability coefficient for chloroform to be 0.2 cm/hour (range, 0.6 and 2.2) and the estimated ratio of the dermally and inhaled absorbed doses to be 0.75 (range, 0.6 and 2.2) cm/hour. This new model showed that a simple steady-state model can be used to predict the degree of dermal absorption for chloroform. It was also shown that the model would be useful in predicting the concentrations of chloroform in shower air and in the exhaled breath of individuals exposed both dermally and by inhalation routes while showering with water containing low amounts (20 µg/L) of chloroform. At this concentration, the model predicted a dermal absorption dose of 0.0047 mg and inhalation of 0.0062 mg. In addition, the model also demonstrated that as the concentration of chloroform rises due to increases in chloroform vapor, the absorbed inhalation dose increases faster and becomes larger than the absorbed dermal dose.

**Species Extrapolation.** No species extrapolation was specifically addressed by this model.

**High-low Dose Extrapolation.** No high-low dose extrapolation was specifically addressed by this model.

**Interroute Extrapolation.** The Chinery-Gleason model examined two routes of exposure, inhalation-only exposure and inhalation/dermal exposure. The model was useful in predicting the concentration of chloroform in shower air and in the exhaled breath of individuals exposed by the dermal and inhalation routes.

### **The McKone Model**

**Risk Assessment.** The McKone model has some use in human chloroform risk assessments, in that the model defined the relationship between the dermal and inhalation exposure to measures of dose and the amounts that can be metabolized by the liver by each route. The model also provided

## 2. HEALTH EFFECTS

information about the inhalation and dermal exposure concentrations at which chloroform metabolism becomes nonlinear in humans.

**Description of the Model.** The McKone (1993) PBPK model addressed potential exposure to chloroform by the inhalation and dermal routes. McKone revised existing shower-compartment, dermal uptake and PBPK models to produce a revised PBPK model for simulating chloroform breath levels in persons exposed in showers by the inhalation route only and by the inhalation and dermal routes combined. Parameters used by this model were taken primarily from two main sources, Jo et al. (1990a) and Corley et al. (1990).

The model was also used to assess the relationship of dermal and inhalation exposure to metabolized dose in the liver, as well as to determine the tap-water concentrations at which hepatic metabolism of dermal and inhalation doses of chloroform become nonlinear. This information is especially useful for risk assessment on persons exposed to a wide range of chloroform concentrations. Experimentally measured ratios of chloroform concentrations in air and breath to tap water concentration (Jo et al. 1990a) were compared with the model predictions.

**Validation of the Model.** The McKone model used one data set to evaluate the model results (Jo et al. 1990a). The McKone model results were also compared to other existing chloroform models, with an in-depth discussion of similarities and differences between those models.

**Target Tissues.** The skin and lung were the target tissues studied in this model. Based on the information presented, the McKone model is appropriate for simulating chloroform breath levels in persons exposed in showers by both exposure routes. A major difference between the McKone model and the Chinery-Gleason model is that the McKone model assumes the skin to be a one compartment organ, whereas the Chinery-Gleason model assumed three compartments within the skin. The McKone model indicated that the ratio of chloroform dermally absorbed in the shower to the concentration in tap water ranges from 0.25 to 0.66 mg/L, and that chloroform can effectively permeate through the skin at a rate of 0.16-0.42 cm/hour during a 10-minute shower.

**Species Extrapolation.** The human was the only species addressed by the McKone model. No extrapolation between species was addressed in this model.

## 2. HEALTH EFFECTS

**High-low Dose Extrapolation.** For tap-water concentrations below 100 mg/L, the model predicted a linear relationship between potential dose (i.e., amounts present in the drinking water, inhaled in a shower, or skin surface contact) and the cumulative metabolized dose. At tap-water concentrations greater than 100 mg/dL for inhalation-only showers and 60 mg/L or normal showers, however, the relationship was no longer linear and modifications to this model may be required.

**Interroute Extrapolation.** The dermal and inhalation routes were addressed in this model. The McKone model did not specifically address interrout extrapolations for chloroform.

### 2.4 MECHANISMS OF ACTION

#### 2.4.1 Pharmacokinetic Mechanisms

**Absorption.** In humans and laboratory animals, chloroform is generally absorbed quickly. Primarily because of its high blood/air partition coefficient, it passes with some ease through most tissue and cellular barriers in the body. Chloroform can be absorbed by inhalation and ingestion, and by dermal routes of exposure. Inhalation studies were performed by Corley et al. (1990) on groups of mice exposed to various concentrations of chloroform for 6 hours and sacrificed 48 hours after the last exposure. Chloroform absorption by the lungs varied by concentration and was generally 34-46%. An earlier study by Von Oettingen (1964) found that when dogs were exposed to 15,000 ppm chloroform, the concentration of chloroform in the blood rose quickly and leveled off, apparently establishing a steady-state concentration in the blood at 80-100 minutes after inhalation exposures began. The average steady-state concentration in the blood was 0.4 mg/mL. Less information is available on the absorption of chloroform by inhalation in humans. Humans exposed to 10,000 ppm of chloroform during surgical anesthesia showed a rapid absorption of chloroform detected in arterial blood samples, with peak concentrations occurring within 2 hours after initiation of anesthesia. The average arterial blood concentration of chloroform was reported to be about 0.1 mg/mL (Smith et al. 1973). Dick et al. (1995) examined the absorption of chloroform through human skin *in vivo* using volunteers and *in vitro* using fresh, excised abdominal skin. In the *in vivo* study, the ventral forearm skin of four male volunteers was dosed with a solution of chloroform in either water or ethanol. The solution remained on the skin for eight hours. When administered in water, the total absorbed dose was 8.2%. In contrast, the total absorbed dose was only 1.68% when chloroform was administered in ethanol. In the *in vitro* study, two doses were applied to the skin and remained there for four hours.

## 2. HEALTH EFFECTS

At study termination, the percentages of the low and high doses of chloroform absorbed were 5.6 and 7.1%, respectively.

Rats and mice exposed to 60 mg/kg  $^{14}\text{C}$ -chloroform orally demonstrated that absorption was practically complete within 48 hours for mice and within 96 hours in rats. Peak blood levels occurred within 1 hour after the oral dose (Brown et al. 1974a). Humans dosed orally with 0.5 grams of  $^{13}\text{C}$ -chloroform delivered as a capsule containing olive oil showed near complete absorption of chloroform within 8 hours after administration. Peak blood levels generally occurred at approximately 1 hour after dosing, with  $^{13}\text{C}$ -chloroform concentrations in blood ranging from 1 to 5  $\mu\text{g}/\text{mL}$  (Fry et al. 1972).

Chloroform can also permeate the stratum corneum of rabbit skin (Torkelson et al. 1976) and mouse skin (Tsuruta 1975). Percutaneous absorption of chloroform across mouse skin was calculated to be approximately 38  $\mu\text{g}/\text{min}/\text{cm}^2$ , indicating that the dermal absorption of chloroform occurs fairly rapidly in mice. No reliable studies report the percutaneous absorption of chloroform in humans; however, a few clinical reports indicate that chloroform is used as a vehicle for drug delivery (King 1993). Islam et al. (1995) investigated the fate of topically applied chloroform in male hairless rats. For exposures under 4 minutes, chloroform-laden water was applied to shaved back skin; for exposures of 4-30 minutes, rats were submerged in baths containing chloroform-laden water. Selected skin areas were tape-stripped a various number of times after various delay periods. It appeared that there was an incremental build-up of chloroform in the skin over the first four minutes. When compared to uptake measured by bath concentration differences, approximately 88% of lost chloroform was not accounted for in the stratum corneum and was assumed to be systemically absorbed.

**Distribution.** Radiolabeled chloroform in mice, once absorbed, is widely distributed to most organs and tissues, specifically the liver, kidney, lungs, spleen, body fat, muscle, and nervous tissue, as reported by Cohen and Hood (1969) and Bergman (1979). Significant accumulations were noted 48 hours after inhalation exposure in the central nervous system, particularly in the cerebellar cortex, spinal nerves, and meninges. When administered orally (Brown et al. 1974a), rats and squirrel monkeys showed significant accumulations of  $^{14}\text{C}$ -chloroform in the brain, lung, muscle, and kidney in both species, with an unusual accumulation of chloroform in the gall bladder of the monkey. When administered orally to mice, similar accumulations of chloroform occurred in the liver, kidney, lung,

## 2. HEALTH EFFECTS

muscle, blood, intestines, and gall bladder (Taylor et al. 1974). Little current information on the distribution of chloroform in humans was available for review.

Chloroform (or phosgene) tends to accumulate to a significantly higher degree in the kidneys of male mice than in those of female mice given equivalent doses, which leads to a higher degree of chloroform nephrotoxicity in male mice. The sex differences seen with the renal cortical accumulation of chloroform or phosgene can be halted if chloroform is administered to castrated males; the sex difference can be reversed if chloroform is administered to females pretreated with testosterone prior to dosing with chloroform. This difference in chloroform accumulation is obviously dependent on the presence of testosterone and is very consistent with a body of evidence that indicates chloroform is more nephrotoxic to male mice than to female mice (Ilett et al. 1973; Pohl et al. 1984; Smith et al. 1973). Although this sex-related toxic effect is known to occur in mice, it is not known at present if a similar effect occurs in humans.

**Excretion.** Chloroform is largely excreted either in the parent form or as the end metabolite (carbon dioxide, CO<sub>2</sub>) in the bodies of both laboratory animals and humans. Corley et al. (1990) demonstrated that mice exposed to 10 or 89 ppm of chloroform by inhalation excreted 99% of the chloroform body burden as CO<sub>2</sub> in exhaled air. As the chloroform concentrations in the air rose however, the amount of chloroform metabolized to CO<sub>2</sub> decreased and the amount of unchanged chloroform rose in the exhaled air, indicating that chloroform metabolism in mice is a saturable process. Rats exposed in a similar manner to 93, 356, and 1,041 ppm chloroform excreted 2, 20, and 42.5%, respectively, of the total body burden of chloroform as unchanged parent compound, indicating that chloroform is metabolized to CO<sub>2</sub> in rats but to a lesser degree than in mice.

In humans, Fry et al. (1972) administered 500 mg of chloroform orally in olive oil in capsular form and found that 17-67% of the total dose of chloroform was exhaled as unchanged parent compound, and that the extent of pulmonary elimination of chloroform was governed inversely by the amount of adipose tissue on the individual ingesting the chloroform. The study also found that most of the chloroform tended to be exhaled between 40 minutes and 2 hours after dosing, which coincided with peak blood levels of chloroform produced at approximately 1 hour after dosing.

## 2. HEALTH EFFECTS

Chloroform in humans tends to be eliminated in a biphasic manner. After ingesting 500 mg of chloroform orally, an initial (a) half-life in the blood of 9-21 minutes was reported, with the second (p) half-life ranging from 86 to 96 hours.

### 2.4.2 Mechanisms of Toxicity

Chloroform is widely distributed to many tissues of the body in laboratory animals and, presumably, in humans; however, many studies have demonstrated that chloroform does not tend to accumulate in the body for extended periods. Chloroform may accumulate to some degree in the body fat stores; however, it quickly partitions out the fat and is excreted by the normal routes and mechanisms. The liver (primary) and kidneys (secondary) are considered to be the target organs for chloroform toxicity in both humans and laboratory animals. Thus, humans (and animals) with existing hepatic or renal disease who are exposed to chloroform, particularly by the oral or inhalation routes, are more likely to be at risk to the toxic effects of chloroform. Reproductive/developmental effects due to chloroform's presence in the drinking water of both humans and laboratory animals has been reported, thereby placing women of childbearing age at a potentially higher risk of reproductive organ anomalies than those women past menopausal age.

Chloroform is largely metabolized in many tissues (particularly the liver and kidney) to  $\text{CO}_2$ , in humans and animals (Brown et al. 1974a; Corley et al. 1990; Fry et al. 1972). Chloroform metabolism is catalyzed by cytochrome P-450, initiating an oxidative cleavage of the C-H bond producing trichloromethanol. Trichloromethanol is unstable and is rapidly transformed to phosgene ( $\text{COCl}_2$ ). Phosgene may react with water to form  $\text{CO}_2$ , which can be exhaled by the lung or excreted in the urine as carbonate or bicarbonate, and hydrochloric acid. Phosgene can also react with other molecules such as cysteine, deplete hepatic GSH (Docks and Krishna 1976; Pohl et al. 1981) and form adducts with microsomal proteins (Corley et al. 1990).

Chloroform toxicity can be attributed to the presence of both the parent compound and the formation of phosgene in most instances of toxicosis. High doses of inhaled chloroform have been reported to cause death (due to respiratory depression), ataxia, narcosis, and central nervous system depression, and are due to the direct effects of the parent compound. Lower doses of chloroform in the air, feed, or water, or administered by gavage, with variable exposure times, may induce toxicity due to the presence of the parent compound or to production of phosgene during metabolism. It appears that the

## 2. HEALTH EFFECTS

metabolite is responsible for hepatocellular damage, resulting in the ultimate elevation of hepatic enzymes (SGPT, SGOT, GGT, etc.) and cell damage/necrosis. The accumulation of chloroform in the renal cortex of mice with the subsequent metabolism to phosgene most likely contributes to the renal toxicity of chloroform seen in male mice. Tubular necrosis, calcification, nephritis, increased kidney weight, alterations in Na/K excretion, and other cellular anomalies were observed in response to one or both of these toxicants. Although the sex-related nephrotoxic effect is known to occur in mice, it is not known at present if a similar effect occurs in humans or other laboratory animals.

### 2.4.3 Animal-to-Human Extrapolations

Many laboratory animal models have been used to describe the toxicity and pharmacology of chloroform. By far, the most commonly used laboratory animal species are the rat and mouse models. Generally, the pharmacokinetic and toxicokinetic data gathered from rats and mice compare favorably with the limited information available from human studies. PBPK models have been developed using pharmacokinetic and toxicokinetic data for use in risk assessment work for the human. The models are discussed in depth in Section 2.3.5. As mentioned previously, male mice have a sex-related tendency to develop severe renal disease when exposed to chloroform, particularly by the inhalation and oral exposure routes. This effect appears to be species-related as well, since experiments in rabbits and guinea pigs found no sex-related differences in renal toxicity.

## 2.5 RELEVANCE TO PUBLIC HEALTH

**Overview.** Data are available regarding health effects in humans and animals after inhalation, oral, and dermal exposure to chloroform; however, data regarding dermal exposure are quite limited. Chloroform was used as a general anesthetic, pain reliever, and antispasmodic for more than a century before its toxic effects were fully recognized. High levels of chloroform (23-400 ppm) (Challen et al. 1958; Phoon et al. 1983) in the air are found specifically in highly industrialized areas. Exposure of the general population to chloroform can also occur via the drinking water as a result of the chlorination process. Occupational exposure is another source of inhalation and/or dermal exposure for humans.

Most of the presented information regarding chloroform toxicity following inhalation exposure in humans was obtained from clinical case reports of patients undergoing anesthesia. In some instances,

## 2. HEALTH EFFECTS

the results in these studies may have been confounded by unreported data, such as the intake of other drugs or the use of artificial respiration during anesthesia.

The target organs of chloroform toxicity in humans and animals are the central nervous system, liver, and kidneys. There is a great deal of similarity between chloroform-induced effects following inhalation and oral exposure. No studies were located regarding reproductive effects in humans after exposure to chloroform alone; however, Bove et al. (1995) studied the effects of drinking-water consumption on birth outcomes and found that exposure to TTHM at levels  $>0.1$  ppm resulted in reduced birth weight and size as well as an increased risk of oral cleft, central nervous system, and neural tube defects. Since the authors did not specifically monitor chloroform levels, the effects seen may be due to exposure to other THMs. In addition, non-THM contaminants in the drinking water may have contributed to the observed effects as well. Only one study was located regarding the developmental effects of chloroform in humans. Animal studies indicate that chloroform can cross the placenta and cause fetotoxic and teratogenic effects. Chloroform exposure has also caused increased resorptions in animals. Epidemiology studies suggest a possible risk of colon and bladder cancer in humans that is associated with chloroform in drinking water. In animals, chloroform was carcinogenic after oral exposure.

### **Minimal Risk Levels for Chloroform.**

#### ***Inhalation MRLs.***

- An MRL of 0.1 ppm has been derived for acute-duration inhalation exposure (14 days or less) to chloroform.

The MRL was based on a hepatic NOAEL of 3 ppm chloroform administered for 6 hours a day for 7 consecutive days to mice (Larson et al. 1994c). Female mice exposed to 100 or 300 ppm exhibited centrilobular hepatocyte necrosis and severe diffuse vacuolar degeneration of midzonal and periportal hepatocytes, while exposure to 10 or 30 ppm resulted in mild-to-moderate vacuolar changes in centrilobular hepatocytes. Decreased eosinophilia of the centrilobular and midzonal hepatocyte cytoplasm relative to periportal hepatocytes was observed at 30 ppm. Livers of mice in the 1 and 3 ppm groups did not differ significantly from control animals and were considered to be NOAELs for liver effects. The NOAEL of 3 ppm was converted to the Human Equivalent Concentration (HEC) as described in Equation 4-10 in Interim Methods for Development of Inhalation Reference



## 2. HEALTH EFFECTS

Concentrations (EPA 1990b). This calculation resulted in a  $\text{NOAEL}_{[\text{HEC}]}$ , of 3 ppm. An uncertainty factor of 30 (3 for extrapolation from animals to humans and 10 for human variability) was applied to the  $\text{NOAEL}_{[\text{HEC}]}$ , value, which resulted in an MRL of 0.1 ppm.

Reports regarding chloroform hepatotoxicity in animals are numerous (Larson et al. 1993, 1994a, 1994b, 1994c). Liver damage has been reported in several other studies, and was usually indicated by liver biochemical/enzyme alterations in rats (Lundberg et al. 1986) and mice (Gehring 1968; Murray et al. 1979) after acute inhalation exposure. Fatty changes (Culliford and Hewitt 1957; Kylin et al. 1963) and liver necrosis (Deringer et al. 1953) were observed histologically in mice after acute inhalation exposure. Histological findings indicative of liver toxicity were also observed in other laboratory animals following inhalation exposure of intermediate duration, but the findings were not dose-related (Torkelson et al. 1976). The 17.3 mg/kg dose was also a NOAEL for kidney effects, but tubular necrosis occurred at 65.6 mg/kg/day.

- An MRL of 0.05 ppm has been derived for intermediate-duration inhalation exposure (15 days to 364 days) to chloroform.

The MRL was based on a LOAEL of 14 ppm in workers exposed to concentrations of chloroform of up to 400 ppm for less than 6 months (Phoon et al. 1983). Vomiting and toxic hepatitis were noted to occur at an inhaled chloroform concentration of 14 ppm. The LOAEL of 14 ppm was divided by an uncertainty factor of 100 (10 for the use of a LOAEL and 10 for human variability) and a modifying factor of 3 (insufficient diagnostic data to determine the seriousness of hepatotoxic effects) to arrive at the MRL of 0.05 ppm. Alterations in liver functions have been reported in several studies in both humans and animals, and is discussed in more detail in the chronic-duration inhalation MRL section immediately below.

- An MRL of 0.02 ppm has been derived for chronic-duration inhalation exposure (365 days or more) to chloroform.

The MRL was based on a LOAEL of 2 ppm in workers exposed to concentrations of chloroform ranging from 2 to 205 ppm for 1-4 years (Bomski et al. 1967). The LOAEL of 2 ppm was divided by an uncertainty factor of 100 (10 for use of a LOAEL and 10 for human variability) to arrive at the MRL of 0.02 ppm. Hepatomegaly was found in 25% of chloroform-exposed workers. Toxic hepatitis was found in 5.6% of the liver enlargement cases. Hepatosteatorosis (fatty liver) was detected in 20.6%

## 2. HEALTH EFFECTS

of liver-enlargement cases. Chloroform-exposed workers had a higher frequency of jaundice over the years than the control group. Alterations in liver functions have been reported in several studies in both humans and animals. In humans, impaired liver function was indicated by increased sulfobromophthalein retention in some patients exposed to chloroform via anesthesia (Smith et al. 1973), in addition to acute toxic hepatitis developing after childbirth in several women exposed to chloroform via anesthesia (Lunt 1953; Royston 1924; Townsend 1939). In contrast, no clinical evidence of liver toxicity was found in another study among chloroform workers exposed to  $\leq 237$  ppm (Challen et al. 1958).

### ***Oral MRLs.***

- An MRL of 0.3 mg/kg/day has been derived for acute-duration oral exposure (14 days or less) to chloroform.

The MRL was based on a NOAEL of 26 mg/kg/day in the drinking water for 4 days for hepatic effects in mice (Larson et al. 1994b). The NOAEL of 26.4 mg/kg/day was divided by an uncertainty factor of 100 (10 for extrapolation from animals to humans and 10 for human variability) to arrive at the MRL of 0.3 mg/kg/day. A study performed by Moore et al. (1982) found renal effects in CFLP Swiss mice dosed at 65.5 mg/kg/day by gavage in oil. Another study by Larson et al. (1993) found both hepatic (elevated SDH, ALT and AST, hepatocyte necrosis) and renal (proximal tubule necrosis) lesions in Fischer 344 rats and hepatic lesions only in B6C3F<sub>1</sub> mice induced by chloroform administered at 34 mg/kg/day once by gavage in oil. Lesions in the Larson et al. (1993) study were ranked as less serious LOAELs.

- An MRL of 0.1 mg/kg/day has been derived for intermediate-duration oral exposure (15-364 days) to chloroform.

This MRL is based on a NOAEL of 15 mg/kg/day for hepatic effects in dogs dosed with chloroform in a capsule 1 time a day, 6 days a week for 6 weeks (Heywood et al. 1979). The NOAEL of 15 mg/kg/day was divided by an uncertainty factor of 100 (10 for extrapolation from animals to humans and 10 for human variability) to arrive at the MRL of 0.1 mg/kg/day. Clinical chemistry parameters showed significantly increase SGPT in the 30 mg/kg/day group beginning at 6 weeks. SGPT activity was not increased in the 15 mg/kg/day group until week 130. Liver effects in animals have been reported in numerous oral studies of intermediate duration. Fatty changes, necrosis,

## 2. HEALTH EFFECTS

increased liver weight, and hyperplasia have been observed in rats exposed to  $\geq 150$  mg/kg/day chloroform in drinking water for 90 days (Palmer et al. 1979). An increased incidence of sporadic, mild, reversible liver changes occurred in mice exposed to chloroform in drinking water at doses of 0.3-114 mg/kg/day for 90 days, but the incidences were not significantly higher than the incidences in controls (Chu et al. 1982a). Fatty and hydropic changes, necrosis, and cirrhosis were observed in mice treated by gavage with  $\geq 50$  mg/kg/day chloroform in oil for 90 days (Bull et al. 1986; Munson et al. 1982) or at 86 mg/kg/day in drinking water for 1 year (Klaunig et al. 1986). In contrast, centrilobular fatty changes observed in mice at 64 mg/kg/day chloroform in drinking water for 90 days appeared to be reversible (Jorgenson and Rushbrook 1980), and no liver effects were found in mice treated with  $\geq 50$  mg/kg/day in aqueous vehicles (Bull et al. 1986). In addition, hepatocellular degeneration was induced in F<sub>1</sub> females in a 2-generation study in which mice were treated by gavage with 41 mg/kg/day chloroform in oil (Gulati et al. 1988).

- An MRL of 0.01 mg/kg/day has been derived for chronic-duration oral exposure (365 days or more) to chloroform.

This MRL is based on a LOAEL of 15 mg/kg/day for hepatic effects in dogs dosed with chloroform 6 days a week for 7.5 years (Heywood et al. 1979). The LOAEL of 15 mg/kg/day was divided by an uncertainty factor of 1,000 (10 for use of a LOAEL, 10 for extrapolation from animals to humans and 10 for human variability) to arrive at the MRL of 0.01 mg/kg/day. SGPT activity was not increased in the 15 mg/kg/day group until week 130, providing the LOAEL on which this MRL was based. Numerous chronic oral studies examined hepatic and renal end points as well as neurological and cancer effects. Serious effects occurred at higher doses; 15 mg/kg/day was the lowest dose used in available animals studies. A NOAEL of 2.46 mg/kg/day for liver and kidney effects (SGPT, SGOT, BUN and SAP) was found in humans who used a dentifrice containing 0.34% or a mouthwash containing 0.43% chloroform for 1-5 years (DeSalva et al. 1975).

The reader is advised to exercise caution in the extrapolation of toxicity data from animals to humans. Species-related differences in sensitivity must be accounted for. Some studies utilized to derive MRLs or otherwise extrapolate data, is dated; however, they do represent the body of knowledge regarding chloroform toxicity. In addition, many of the human studies quoted involved clinical case reports in which chloroform was utilized either as an anesthetic or as an agent of suicide. Such doses are clearly

## 2. HEALTH EFFECTS

excessive and would not be encountered by the general population. These and other issues are addressed in Section 2.10.

**Death.** Chloroform levels of  $\approx 40,000$  ppm cause death in patients under chloroform anesthesia (Featherstone 1947; Whitaker and Jones 1965). Death is usually due to severe respiratory depression/failure or disturbances in cardiac rhythm. Accidental or intentional ingestion of large doses of chloroform may lead to death (Piersol et al. 1933). Death in humans after oral exposure to chloroform is usually caused by respiratory obstruction by the tongue due to jaw relaxation, central respiratory paralysis, acute cardiac failure, or severe hepatic injury (Piersol et al. 1933; Schroeder 1965).

The levels of chloroform exposure that cause death in animals are usually lower than those administered to patients to induce anesthesia; however, the duration of exposure in animals is generally longer. Following acute exposure to high concentrations of chloroform, all male mice died; however, most females survived the exposure for several months (Deringer et al. 1953). Survival was associated with lower testosterone levels, as suggested by the higher mortality rate in noncastrated adult males. This conclusion is supported by similar observations of higher survival rates in female rats, compared to male rats, after intermediate-duration exposure to chloroform (Torkelson et al. 1976). In regard to  $LC_{50}$  values in rats, survival rates were highest among females and lowest among young adult males. The correlation between mortality rates and male hormone levels is evident. Deaths were apparently potentiated by starvation, dehydration, and exhaustion (Ekstrom et al. 1986, 1988; Royston 1924; Townsend 1939). Increased mortality was also observed in rats and mice after oral exposure of intermediate and chronic duration (Balster and Borzelleca 1982; Chu et al. 1982a; Jorgenson et al. 1985; Klaunig et al. 1986; NCI 1976; Palmer et al. 1979; Roe et al. 1979). Deaths were caused by toxic liver and kidney effects, and tumors. Deaths after dermal exposures in either humans or laboratory animals have not been reported.

Chloroform concentrations in air and drinking water in the general environment or near hazardous waste sites are not likely to be high enough to cause death in humans after acute exposure. Whether chronic exposure to low levels of chloroform in the environment, drinking water, or hazardous wastes could shorten the life span of humans is not currently known. Currently available epidemiologic findings about the chronic exposure to chloroform are inconsistent at best which, in large part, may be due to study design issues.

## 2. HEALTH EFFECTS

### **Systemic Effects.**

**Respiratory Effects.** The respiratory failure observed in patients under chloroform anesthesia was probably due to a direct effect of chloroform on the respiratory center of the central nervous system. A decline of the systolic pressure in the cerebral vessels may also contribute to respiratory failure, as demonstrated in animals: when respiration had stopped under chloroform anesthesia, the animals (species not specified) breathed again if positioned head down (Featherstone 1947). Upper respiratory tract obstruction can occur in patients after inhalation exposure to chloroform via anesthesia (Featherstone 1947) and after chloroform ingestion (Schroeder 1965). Few autopsy reports were located in the literature. Hemorrhage into the lungs, without any signs of consolidation, was reported in a case study involving death after inhalation exposure (Royston 1924); however, congested lungs with pneumonic consolidation were observed in a man who died after drinking chloroform (Piersol et al. 1933).

In addition to lower respiratory tract effects, chloroform has been demonstrated to induce changes in the nasal region of rats and mice after inhalation and oral exposure. Increased sizes of goblet cells and nasal epithelium, degeneration of the nasal epithelium and Bowman's glands, changes in the proliferation rates of cells, new bone formation, and changes in biochemical parameters (especially cytochrome P-450-2E1) have been reported (Larson et al. 1995b, 1996; Mery et al. 1994), indicating that chloroform can adversely affect the upper as well as the lower respiratory tract at low concentrations. The incidence of respiratory lesions after oral (gavage) administration also indicates a systemic mechanism of action for chloroform-induced toxicity.

Interstitial pneumonitis was observed in male rats and rabbits after inhalation exposure to 85 or 50 ppm chloroform, respectively, for 6 months (Torkelson et al. 1976). In most oral studies, no exposure-related histopathological changes were observed in the lungs of exposed animals (Gulati et al. 1988; Jorgenson and Rushbrook 1980; NCI 1976; Palmer et al. 1979; Roe et al. 1979).

Respiratory effects are more likely to occur after inhalation exposure to high concentrations of chloroform. It has been demonstrated that chloroform has a destructive influence on the pulmonary surfactant (Enhorning et al. 1986). This effect is probably due to the solubility of phospholipids in the surfactant monolayer and can cause collapse of the respiratory bronchiole due to the sudden increase in inhalation tension. Immediate death after chloroform inhalation may be due principally to this effect

## 2. HEALTH EFFECTS

in the lungs (Fagan et al. 1977). It is unlikely that exposure levels of chloroform in the general environment or at hazardous waste sites would be high enough to cause these severe respiratory effects.

*Cardiovascular Effects.* Chloroform induces cardiac arrhythmia in patients exposed to chloroform via anesthesia (Smith et al. 1973; Whitaker and Jones 1965). Similarly, heart effects were observed upon electrocardiography of an individual who accidentally ingested chloroform (Schroeder 1965).

Hypotension was observed in 12-27% of patients exposed to chloroform via anesthesia (Smith et al. 1973; Whitaker and Jones 1965) and also was observed in a patient who ingested chloroform (Storms 1973).

No studies were located regarding cardiovascular effects in animals after inhalation exposure to chloroform. No histopathological changes were observed in the heart of rats, mice (NCI 1976), or dogs (Heywood et al. 1979) chronically exposed to chloroform; however, cardiovascular function was not assessed in these studies. It has been demonstrated in an *in vitro* study on heart-lung preparations of guinea pigs that chloroform may cause a permanent contractile failure of the heart (Doring 1975). The effect is due to structural damage of the transverse tubular system and is accompanied by increased storage of adenosine triphosphate (ATP) and phosphocreatine. The *in vitro* induction of changes showed that contractile failure is a direct effect on the cardiovascular system rather than an indirect cardiovascular effect on the central nervous system. This mechanism may operate in humans exposed to high vapor concentrations such as those used in anesthesia or in humans exposed to high oral doses from accidental or intentional ingestion. It is unlikely, however, that concentrations of chloroform in the environment would be high enough to cause overt cardiovascular effects.

Cytotoxicity of chloroform (1,000 ppm) in male Sprague-Dawley rat cardiac myocytes has been examined *in vitro*. Cell viability was measured using the criterion of Trypan blue exclusion as well as counting the number of rod and spherical cells in the media. Creatinine phosphokinase (CPK) leakage was measured as an indirect measurement of heart cell function. Myocytes treated with chloroform showed statistically significant decreases in cell viability and significant decreases in rod-shaped cells compared to controls. Significant increases in enzyme leakage of CPK from myocytes were noted (El-Shenawy and Abdel-Rahman 1993b). The effects of various concentrations of chloroform on the *in vitro* transfer of dyes between cardiac myocytes from Sprague-Dawley rats has also been examined (Toraason et al. 1992). The cells were exposed to one of 11 concentrations of chloroform in dimethyl

## 2. HEALTH EFFECTS

sulfoxide (DMSO), and Lucifer yellow CH dye injected the cells, and the rate of transfer of dye from the injected myocyte to the non-injected myocyte recorded. As the cells were exposed to increasing concentrations of chloroform, the number of cells that transferred the dye decreased to zero. Heart cells also tended to beat slower or stop beating completely when exposed to chloroform but resumed normal spontaneous beating when chloroform was washed out. This *in vitro* data suggest that incorporation of halocarbons in the membrane may block intercellular communication through modification of the immediate environment of gap junctions. The data from these two studies indicate that chloroform exposure may induce reversible toxicity in the heart.

***Gastrointestinal Effects.*** Nausea and vomiting were not only frequently observed side effects in patients exposed to chloroform via anesthesia (Hakim et al. 1992; Royston 1924; Smith et al. 1973; Townsend 1939; Whitaker and Jones 1965), but also occurred in humans exposed to lower chloroform concentrations (22-237 ppm) in occupational settings (Challen et al. 1958; Phoon et al. 1983). Vomiting, gastric distress, and pain were observed in individuals who intentionally or accidentally ingested high doses of chloroform (Piersol et al. 1933; Schroeder 1965; Storms 1973).

No studies were located regarding gastrointestinal effects in animals after inhalation exposure to chloroform. Vomiting in dogs (Heywood et al. 1979) and gastric erosions in rats (Thompson et al. 1974) were observed in oral studies of intermediate duration. These results suggest that severe gastrointestinal irritation in humans and animals is due to direct damage of the gastrointestinal mucosa caused by ingesting high concentrations of chloroform (Piersol et al. 1933; Schroeder 1965; Thompson et al. 1974). Nausea and vomiting experienced by occupationally exposed individuals is likely due to neurotoxicity. Since toxic hepatitis may occur at occupational levels as low as 2 ppm (Bomski et al. 1967), it is possible that levels of chloroform in the air at hazardous waste sites may be high enough to cause some liver effects with secondary gastrointestinal effects, if exposure is prolonged.

***Hematological Effects.*** Information regarding hematological effects in humans exposed to chloroform is limited. Increased prothrombin time was observed in some patients, following exposure to chloroform via anesthesia (Smith et al. 1973). This effect, however, reflects chloroform hepatotoxicity, because prothrombin is formed in the liver. Decreased erythrocytes and hemoglobin were observed in a patient who was chronically exposed to chloroform in a cough medicine (Wallace 1950).

## 2. HEALTH EFFECTS

No hematological effects were observed in rats, rabbits, guinea pigs, or dogs after inhalation exposure to chloroform for intermediate durations (Torkelson et al. 1976). Studies report conflicting results regarding hematological effects in animals after oral exposure to chloroform.

No conclusion about hematological effects in humans after exposure to chloroform can be made on the basis of one case study in humans. From the experimental data in animals, it is evident that all hematological effects observed in rats were due to oral exposure of acute, intermediate, or chronic duration. It is possible that the hematological effects observed in rats are transient. Human exposure to chloroform in the environment, drinking water, or at hazardous waste sites is likely to cause few or no hematological effects.

***Musculoskeletal Effects.*** Little data is available that examines the effects of chloroform toxicity on the musculoskeletal system; however, it appears that chloroform has few significant toxic effects on this system.

***Hepatic Effects.*** The liver is a primary target organ of chloroform toxicity in humans and animals after inhalation and oral exposure, with some evidence that suggests that the damage may be reversible (Wallace 1950). Impaired liver function was indicated by increased sulfobromophthalein retention in some patients exposed to chloroform via anesthesia (Smith et al. 1973). Acute toxic hepatitis developed after childbirth in several women exposed to chloroform via anesthesia (Lunt 1953; Royston 1924; Townsend 1939). Upon autopsy, centrilobular necrosis was observed in the women who died; however, the hepatotoxicity was associated with exhaustion from prolonged delivery, starvation, and dehydration, indicating improper handling of the delivery procedure by an obstetrician. Toxic hepatic disease, characterized by hepatomegaly and abnormal liver sonograms as late as seven days after an unknown amount of oral chloroform, has been reported (Hakim et al. 1992). Elevated liver enzymes and changes in GGT, alpha-feto protein and retinol binding protein were reported in a female who injected herself intravenously and also consumed chloroform orally during a 12-hour period (Rao et al. 1993). During occupational exposure to concentrations ranging from 14 to 400 ppm, chloroform hepatotoxicity was characterized by jaundice (Phoon et al. 1983), hepatomegaly, enhanced SGPT and SGOT activities, and hypergammaglobulinemia following exposure to concentrations ranging from 2 to 205 ppm (Bomski et al. 1967). In contrast, no clinical evidence of liver toxicity was found in another study among chloroform workers exposed to  $\leq 237$  ppm (Challen et al. 1958). Case reports of intentional and accidental ingestion of high doses ( $\geq 2,410$  mg/kg) of chloroform indicate severe liver



## 2. HEALTH EFFECTS

injury (Piersol et al. 1933; Schroeder 1965; Storms 1973). The diagnosis was supported by clinical and biochemical results: fatty degeneration and extensive centrilobular necrosis were observed in one patient who died (Piersol et al. 1933). Liver damage was induced by chronic use of a cough medicine containing chloroform (Wallace 1950), but not by chronic exposure to chloroform in mouthwash (De Salva et al. 1975). An intermediate-duration inhalation MRL of 0.05 ppm was derived from the LOAEL of 14 ppm from the data presented by Phoon et al. (1983); a chronic-duration inhalation MRL of 0.02 ppm was derived from the LOAEL of 2 ppm from the data presented by Bomski et al. (1967).

Reports regarding chloroform hepatotoxicity in animals are numerous (Larson et al. 1993, 1994a, 1994b, 1994c, 1995b, 1996; Nakajima et al. 1995; Pereira 1994; Wang et al. 1994, 1995). An acute-duration inhalation MRL of 0.1 ppm was based on a NOAEL for hepatic effects in mice exposed to 3 ppm chloroform for 6 hours a day for 7 days (Larson et al. 1994c).

Liver damage was indicated by biochemical changes in rats (Lundberg et al. 1986; Nakajima et al. 1995; Wang et al. 1994, 1995) and mice (Gehring 1968; Murray et al. 1979) after acute inhalation exposure. Fatty changes (Culliford and Hewitt 1957; Kylin et al. 1963) and liver necrosis (Deringer et al. 1953; Larson et al. 1995b, 1996; Pereira 1994) were observed histologically in mice and rats after acute inhalation exposure. Histological findings indicative of liver toxicity were also observed in rabbits and guinea pigs following inhalation exposure of intermediate duration, but the findings were not dose-related (Torkelson et al. 1976). Liver effects have been observed in many species (rats, mice, and dogs) that were tested by the oral route by various methods of administration (gavage or drinking water) and durations (acute, intermediate, or chronic). Observed effects include increased liver weight, increased serum levels of transaminases indicative of liver necrosis, and histological evidence of swelling, fatty changes, hydropic changes, vacuolation, necrosis, hyperplasia, cirrhosis, macrophage and neutrophil infiltration, and toxic hepatitis (Bull et al. 1986; Chu et al. 1982b; Heindel et al. 1995; Heywood et al. 1979; Jones et al. 1958; Jorgenson and Rushbrook 1980; Klaunig et al. 1986; Larson et al. 1993, 1994b, 1995b, 1996; Nakajima et al. 1995; NCI 1976; Pereira 1994; Tumasonis 1985, 1987). Two acute oral studies define a LOAEL and a NOAEL for liver effects in mice. Fatty infiltration was observed in mice given a single gavage dose of 35 mg/kg/day chloroform in oil (Jones et al. 1958). No toxic effects on the livers of mice occurred after a single dose of 17.3 or 59.2 mg/kg chloroform in oil, but increased SGPT occurred at 199 mg/kg (Moore et al. 1982). The 17.3 mg/kg dose was also a NOAEL for kidney effects, but tubular necrosis occurred at 65.6 mg/kg/day. In a 7.5-year study in which dogs were administered chloroform in toothpaste, SGPT activity was

## 2. HEALTH EFFECTS

significantly increased at 30 mg/kg/day beginning at 6 weeks (Heywood et al. 1979). SGPT activity was not increased at 15 mg/kg/day until 130 weeks. Therefore, 15 mg/kg/day was a NOAEL for intermediate-duration exposure and a LOAEL for chronic-duration exposure. The 15 mg/kg/day dose was used to derive MRL values of 0.1 and 0.01 mg/kg/day for intermediate- and chronic-duration oral exposure, respectively.

Data regarding chloroform-induced hepatotoxicity were also supported by results obtained after acute intraperitoneal exposure in rats (Bai et al. 1992; Ebel et al. 1987; El-Shenawy and Abdel-Rahman 1993a; Lundberg et al. 1986; Wang et al. 1994), mice (Klaassen and Plaa 1966), dogs (Klaassen and Plaa 1967), and gerbils (Ebel et al. 1987). No hepatic effects were observed in rabbits when chloroform was applied to their skin for 24 hours (Torkelson et al. 1976). The toxicity of chloroform on laboratory animal hepatocytes *in vitro* has been reported (Azri-Meehan et al. 1992, 1994; Bai and Stacey 1993; El-Shenawy and Abdel-Rahman 1993a; Suzuki et al. 1994).

As discussed in Section 2.3.3, the mechanism of chloroform-induced liver toxicity may involve metabolism to the reactive intermediate, phosgene, which binds to lipids and proteins of the endoplasmic reticulum, lipid peroxidation, or depletion of GSH by reactive intermediates. Because liver toxicity has been observed in humans exposed to chloroform levels as low as 2 ppm in the workplace and in several animal species after inhalation and oral exposure, it is possible that liver effects could occur in humans exposed to environmental levels, to levels in drinking water, or to levels found at hazardous waste sites.

**Endocrine Effects.** No reports of chloroform toxicity to endocrine organs have been reported.

**Renal Effects.** Clinical reports indicate that the renal damage observed in women exposed to chloroform via anesthesia during prolonged parturition most likely occurs when chloroform anesthesia is associated with anoxia. Competitive swimmers who swim in indoor pools have been reported to have elevated  $\beta$ -2microglobulin, suggesting some degree of renal damage (Aiking et al. 1994). Case studies of individuals who intentionally or accidentally ingested high doses of chloroform report biochemical changes indicative of kidney damage, as well as fatty degeneration at autopsy (Piersol et al. 1933; Schroeder 1965). Albuminuria and casts were also reported in a case of chronic use of a cough medicine containing chloroform (Wallace 1950); however, no renal effects were observed in individuals chronically exposed to chloroform in a mouthwash (De Salva et al. 1975).

## 2. HEALTH EFFECTS

Renal effects of chloroform after inhalation have also been examined in animals (Larson et al. 1994b, 1994c, 1996). Kidney effects in animals after inhalation exposure to chloroform include tubular necrosis, tubular calcification, increased kidney weight, cloudy swelling, mineralization of the cortex, and interstitial nephritis. Animal studies regarding renal toxicity after oral exposure are numerous. Effects include acute toxic nephrosis, tubular dilation, necrosis and regeneration, chronic inflammation, mineralized concretions, hyaline cast formation, and fatty degeneration. The effects of dose and vehicle have been examined (Heindel et al. 1995; Larson et al. 1993, 1995b; Lipsky et al. 1993).

Mice seem to be more sensitive to chloroform-induced renal toxicity than other experimental animals. Certain strains of male mice are susceptible to chloroform-induced nephrotoxicity, while female mice appear to be somewhat resistant (Culliford and Hewitt 1957; Eschenbrenner and Miller 1945b; Larson et al. 1996). Castrated mice were no longer susceptible to the effect, and testosterone treatment increased the severity of kidney damage in females, suggesting the role of hormones in chloroform-induced nephrotoxicity. It has been demonstrated that sensitivity to kidney damage is related to the capacity of the kidney to metabolize chloroform to phosgene (Pohl et al. 1984). The activation of chloroform to its reactive metabolites appeared to be cytochrome P-450-dependent: the covalent binding to microsomal protein required nicotinamide adenine dinucleotide phosphate (NADPH) and oxygen, and could be inhibited by carbon monoxide (Hook and Smith 1985; Smith and Hook 1983, 1984; Smith et al. 1984). Furthermore, administration of chloroform to male mice caused a depletion of renal GSH, indicating that GSH can react with reactive intermediates, thereby reducing the extent of the reaction with tissue MMBs and kidney damage.

The renal toxicity of chloroform in rats after intraperitoneal dosing has also been reported (Kroll et al. 1994a, 1994b).

It is likely that kidney effects may occur in humans after inhalation or oral exposure to high levels of chloroform; however, it is not known whether such effects would occur at the levels of chloroform found in the environment, in drinking water, or at hazardous waste sites.

***Dermal Effects.*** No reports are available on the toxicity of chloroform to skin after inhalation and oral exposures in humans. Stratum comeum damage was reported after a topical exposure of chloroform of 15 minutes duration for 6 consecutive days (Malten et al. 1968). Chloroform was used as a vehicle for the topical application of aspirin for the treatment of painful herpes zoster lesions in

## 2. HEALTH EFFECTS

male and female humans. The only reported side-effect was an occasional burning sensation to the skin as the chloroform evaporated after application (King 1993).

Few reports exist on the dermal effects of chloroform in animals after inhalation or oral exposures. Alopecia has been observed in pregnant rats (Thompson et al. 1974) and in mice (Gulati et al. 1988). Skin irritation and necrosis and been reported in rabbits after topical application of chloroform (Smyth et al. 1962; Torkelson et al. 1976).

**Ocular Effects.** No studies were located regarding the ocular effects of chloroform in humans or animals.

**Body Weight Effects.** Decreased body weight has been observed frequently in animals after inhalation or oral exposure to chloroform, although the degree of body weight changes are somewhat variable and may be linked to taste aversion (in oral studies) (Chu et al. 1982b; Larson et al. 1995b, 1996; Munson et al. 1982; Newell and Dilley 1978; Torkelson et al. 1976; Tumasonis et al. 1985, 1987). The degree of decreased weight gain was often dose-related and was caused by chloroform toxicity. Decreased weight gain generally occurred at exposure levels similar to or lower than those that induced liver and kidney effects in animals. The possibility of effects on body weight in humans exposed to ambient or elevated levels of chloroform cannot be dismissed.

**Immunological and Lymphoreticular Effects.** No studies were located regarding immunological effects in humans after inhalation, oral, or dermal exposure to chloroform.

Information about immunological effects in animals is limited. After repeated inhalation exposure to chloroform, mortality was increased in mice challenged with streptococcus infection, suggesting increased susceptibility (Aranyi et al. 1986). However, the bacterial activity of alveolar macrophages was not suppressed in this study. After acute oral exposure, reduced lymphocyte counts were observed in rats (Chu et al. 1982b). Furthermore, humoral immunity was depressed in mice exposed to 50 mg/kg/day chloroform for acute or intermediate durations (Munson et al. 1982). In contrast, cell-mediated immunity was influenced only at high chloroform concentrations administered orally for intermediate durations; however, the chloroform-induced immunological changes appeared to be more severe following acute exposure. *In vitro* treatment of serum with chloroform resulted in a loss of complement activity (Stefanovic et al. 1987). Immunological effects may result from the ability of

## 2. HEALTH EFFECTS

chloroform to dissociate antigen-antibody complexes, since it can cause dissociation of certain enzyme-inhibitor complexes (Berger et al. 1983). Every day, humans are exposed to very low levels of chloroform in the environment, mainly via inhalation and oral exposure (Hajimiragha et al. 1986; Peoples et al. 1979; Wallace et al. 1987a, 1989). There is a risk of chloroform exposure at or near hazardous waste sites. Although no evidence that chloroform can cause immunological effects in humans was located in the literature, the possibility remains that these effects may result from exposure to chloroform.

**Neurological Effects.** Neurological effects in humans after acute inhalation exposure to chloroform are well documented because chloroform has been used as an anesthetic for surgery. Inhaled chloroform acts as a depressant on the central nervous system. Chronic inhalation exposure to chloroform resulted in exhaustion, lack of concentration, depression, and irritability in occupationally exposed people (Challen et al. 1958). In a case study, chloroform inhalation for 12 years resulted in psychotic episodes, hallucinations, and convulsions (Heilbrunn et al. 1945). Central nervous system toxicity was observed in humans after oral exposure to chloroform, which suggests that the effects of inhalation and oral exposure are similar. In case reports of patients who intentionally or accidentally ingested several ounces of chloroform, deep coma with abolished reflexes occurred within a few minutes (Piersol et al. 1933; Schroeder 1965; Storms 1973).

Inhalation exposure to high chloroform concentrations induced narcosis (Lehmann and Flury 1943; Sax 1979) and reversible impairment of memory retrieval in animals. High, single, oral doses of chloroform caused ataxia, incoordination, anesthesia, and brain hemorrhage in mice (Balster and Borzelleca 1982; Bowman et al. 1978). Behavioral effects were observed at lower oral doses.

Chloroform concentrations from 1.5 to 6 mmol chloroform were used to determine how chloroform may modify glutamate receptor agonist responses in mouse brain cortical wedges. The two agonists examined were N-methyl-D-aspartate (NMDA) and alpha-amino-3-hydroxy-5-methyl-4-isoxazole propionate (AMPA). Responses were determined by measuring electrical responses within the cortical slices. Three mmol of chloroform selectively inhibited AMPA but did not affect NMDA responses. Higher concentrations of chloroform failed to inhibit the AMPA or NMDA content in the wedges (Carla and Moroni 1992). Male Sprague-Dawley rats administered a single 200 mg/kg dose of chloroform experienced a significant decrease in midbrain 5-HIAA levels and a significant increase in hypothalamic dopamine concentrations (Kanada et al. 1994).

## 2. HEALTH EFFECTS

The clinical effects of chloroform toxicity on the central nervous system are well documented. However, the molecular mechanism of action is not well understood. It has been postulated that anesthetics induce their action at a cell-membrane level due to lipid solubility. The lipid-disordering effect of chloroform and other anesthetics on membrane lipids was increased by gangliosides (Harris and Groh 1985), which may explain why the outer leaflet of the lipid bilayer of neuronal membranes, which has a large ganglioside content, is unusually sensitive to anesthetic agents. Anesthetics may affect calcium-dependent potassium conductance in the central nervous system (Caldwell and Harris 1985). The blockage of potassium conductance by chloroform and other anesthetics resulted in depolarization of squid axon (Haydon et al. 1988).

Based upon existing data, the potential for neurological and behavioral effects in humans exposed to chloroform at levels found in the environment, in drinking water, or at hazardous waste sites is very minimal.

**Reproductive Effects.** It has not been definitively determined whether chloroform exposure induces reproductive effects in humans. No studies were located regarding reproductive effects in humans after inhalation or dermal exposure to chloroform. Only one study was located regarding reproductive effects in humans after oral exposure to chloroform. Bove et al. (1995) studied the effects of drinking-water consumption on birth outcomes and found that exposure to THM at levels  $>0.1$  ppm resulted in reduced birth weight and size as well as an increased risk of oral cleft, central nervous system, and neural tube defects. These results should be viewed with caution since the authors did not specifically monitor chloroform levels. The effects seen may be due to exposure to other THMs or non-THM contaminants in the drinking water.

Studies indicate that exposure to chloroform causes reproductive effects in animals. Dose-related increases of embryonal resorptions were observed in rats and mice after inhalation or oral exposure to chloroform during gestation. A significant increase in the incidence of abnormal sperm was observed in mice after acute inhalation exposure (Land et al. 1979, 1981). Gonadal atrophy was observed in male and female rats treated by gavage (Palmer et al. 1979). Fertility was not affected in either generation of mice exposed orally to chloroform in a 2-generation study (Gulati et al. 1988). In contrast, a 2-generation study in Sprague-Dawley rats and Swiss mice demonstrated significant decreases in combined live pup weights and in the proportion of male pups born live (rats), a significant reduction in sperm concentrations and sperm head counts, and increased numbers of unclear

## 2. HEALTH EFFECTS

or no estrous cycles (mice). However, the animals in this study were administered drinking water containing a mixture of 25 contaminants; thus, other toxicants may have elicited these effects. Oral exposure to chloroform did not induce histopathological changes in the reproductive organs of rats exposed for intermediate durations (Jorgenson and Rushbrook 1980) or in rats and mice (NCI 1976) and dogs (Heywood et al. 1979) exposed for chronic durations.

**Developmental Effects.** One study regarding developmental effects in humans after oral exposure to chloroform has been reported (Kramer et al. 1992). The estimated relative risk of low birth weight associated with drinking-water sources having chloroform levels of  $\geq 10$   $\mu\text{g/L}$  was 30% higher than sources with undetectable levels of chloroform. Prematurity was not associated with chloroform/THM exposure. The estimated relative risk of intrauterine growth retardation associated with drinking-water supplies with chloroform concentrations of  $>10$   $\mu\text{g/L}$  was 80% higher than the risk for sources with undetectable levels of chloroform. Sources with intermediate chloroform levels (1-9  $\mu\text{g/L}$ ) had an elevated risk of 30%. There seems to be reasonable evidence to suggest that some correlation with an increased risk of intrauterine growth retardation associated with higher concentrations of waterborne chloroform and dichlorobromomethane does exist.

Inhalation exposure to chloroform during gestation induced fetotoxicity and teratogenicity in rats (Schwetz et al. 1974) and mice (Murray et al. 1979). Decreased fetal crown-rump length, decreased ossifications, imperforate anus (rats), and cleft palate (mice) were observed in the offspring of exposed dams. In contrast, fetotoxicity (decreased fetal weight), but not teratogenicity, was observed in rats after oral exposure to chloroform (Ruddick et al. 1983; Thompson et al. 1974). Increased resorptions were observed in rats and rabbits (Thompson et al. 1974). In a 2-generation oral study, degeneration of the epididymal ductal epithelium was observed in mice of the F<sub>1</sub> generation (Gulati et al. 1988). Due to its chemical nature, chloroform can cross the placenta easily, as demonstrated by its detection in the placenta and fetuses of mice a short time after inhalation exposure (Danielsson et al. 1986). Chloroform may accumulate in the amniotic fluid and fetal tissues. Various developmental effects may result from exposure, depending on the period of *in utero* exposure. Although no studies have conclusively reported developmental effects in humans, chloroform (or in tandem with other organic halomethanes) may have the potential to cause developmental effects in humans. Whether such effects could occur from exposure to levels in the environment, in drinking water, or at hazardous waste sites is not known.

## 2. HEALTH EFFECTS

**Genotoxic Effects.** *In vivo* and *in vitro* studies of the genotoxic effects of chloroform are summarized in Tables 2-5 and 2-6. Information regarding genotoxic effects after *in vivo* exposure to chloroform is limited. Mice exposed to chloroform by gavage had an increase in sister chromatid exchange frequency in bone marrow cells (Morimoto and Koizumi 1983). No sperm-head abnormalities were noted in mice after receiving 5 daily intraperitoneal injections of chloroform in concentrations up to 0.25 mg/kg/day in corn oil (Topham 1980). Oral exposure to chloroform did not increase UDS in rat hepatocytes (Mirsalis et al. 1982). Chloroform exposure caused mitotic arrest in grasshopper embryos (Liang et al. 1983) and a nonsignificant increase in the recessive lethals in *Drosophila melanogaster* (Gocke et al. 1981). In general, most of the assays for chloroform genotoxicity are negative. Therefore, it seems that chloroform is a weak mutagen and that its potential to interact with DNA is low.

In *in vitro* experiments, chloroform did not cause reverse mutations in *Salmonella typhimurium* (Gocke et al. 1981; San Augustin and Lim-Sylianco 1978; Simmon et al. 1977; Uehleke et al. 1977; Van Abbe et al. 1982; Varma et al. 1988) or in *Escherichia coli* (Kirkland et al. 1981) with or without metabolic activation. Inconclusive results were obtained in *Saccharomyces cerevisiae* and *Schistosaccharomyces pombe* (Callen et al. 1980; De Serres et al. 1981). Chloroform, however, induced Aneuploidia in *Aspergillus nidulans* (Crebelli et al. 1988). Chloroform caused forward mutations in L5 178Y mouse lymphoma cells after metabolic activation (Mitchell et al. 1988), but did not cause mutations at 8-azaguanine locus in Chinese hamster lung fibroblasts (Sturrock 1977) or sister chromatid exchange in Chinese hamster ovary cells (White et al. 1979). A study performed in mice examined the ability of chloroform to induce UDS in hepatocytes *in vitro* from 15-week-old female B6C3F<sub>1</sub> mice. Chloroform concentrations ranged from 0.01 to 10 mmol. Mice were sacrificed at 2 and 12 hours postdosing to determine if and when UDS began to occur. Dimethylnitrosamine, a known inducer of UDS, was used as a positive control and did induce UDS in these hepatic cells. No induction of DNA repair was observed at any concentration of chloroform at either the 2-hour or 12-hour posttreatment groups. All concentrations of chloroform added to the cell cultures of mouse hepatocytes proved to be toxic. The study showed that chloroform is not directly genotoxic in hepatocytes of female mice, either *in vivo* or *in vitro*, despite the fact that it is the target organ of chloroform carcinogenesis (Larson et al. 1994a). In human lymphocytes, chloroform did not induce UDS (Peroccio and Prodi 1981) and did not increase the frequency of sister chromatid exchange and chromosome aberrations (Kirkland et al. 1981). In contrast, increases in sister chromatid exchange were reported after metabolic activation in another study (Morimoto and Koizumi 1983).



Table 2-5. Genotoxicity of Chloroform *In Vivo*

Species (test system)	End point	Results	Reference
Mammalian cells:			
Rat hepatocytes	Unscheduled DNA synthesis	-	Mirsalis et al. 1982
Mouse bone marrow	Sister chromatid exchange	-	Morimoto and Koizumi 1983
Mouse	Sperm-head abnormalities	-	Topham 1980
Mouse	Sperm abnormalities	+	Land et al. 1981
Grasshopper embryo	Mitotic arrest	+	Liang et al. 1983
<i>Drosophila melanogaster</i>	Recessive lethals	-	Gocke et al. 1981
Host-mediated assays:			
<i>Salmonella typhimurium</i> TA1535 (mouse host-mediated assay)	Reverse mutation	-	San Agustin and Lim-Sylianco 1978
<i>S. typhimurium</i> TA1537 (mouse host-mediated assay) (males only)	Reverse mutation	+	San Agustin and Lim-Sylianco 1978

- = negative result; + = positive result; DNA = Deoxyribonucleic acid

Table 2-6. Genotoxicity of Chloroform *In Vitro*

Species (test system)	End point	Results		Reference
		With activation	Without activation	
Prokaryotic organism:				
<i>Salmonella typhimurium</i> TA98	Reverse mutation	-	-	Gocke et al. 1981
<i>S. typhimurium</i> TA100	Reverse mutation	-	-	Gocke et al. 1981
<i>S. typhimurium</i> TA1535	Reverse mutation	-	-	Gocke et al. 1981
<i>S. typhimurium</i> TA1535	Reverse mutation	-	-	Uehleke et al. 1977
<i>S. typhimurium</i> TA1538	Reverse mutation	-	-	Uehleke et al. 1977
<i>S. typhimurium</i> TA98	Reverse mutation	-	-	Simmon et al. 1977
<i>S. typhimurium</i> TA100	Reverse mutation	-	-	Simmon et al. 1977
<i>S. typhimurium</i> TA1535	Reverse mutation	-	-	Simmon et al. 1977
<i>S. typhimurium</i> TA1537	Reverse mutation	-	-	Simmon et al. 1977
<i>S. typhimurium</i> TA98	Reverse mutation	-	-	Van Abbe et al. 1982
<i>S. typhimurium</i> TA100	Reverse mutation	-	-	Van Abbe et al. 1982
<i>S. typhimurium</i> TA1535	Reverse mutation	-	-	Van Abbe et al. 1982
<i>S. typhimurium</i> TA1537	Reverse mutation	-	-	Van Abbe et al. 1982
<i>S. typhimurium</i> TA1538	Reverse mutation	-	-	Van Abbe et al. 1982
<i>S. typhimurium</i> TA98	Reverse mutation	-	(+)	Varma et al. 1988
<i>S. typhimurium</i> TA100	Reverse mutation	+	(+)	Varma et al. 1988
<i>S. typhimurium</i> TA1535	Reverse mutation	-	(+)	Varma et al. 1988
<i>S. typhimurium</i> TA1537	Reverse mutation	-	(+)	Varma et al. 1988
<i>S. typhimurium</i> TA98	Reverse mutation	Not tested	-	San Augustin and Lim-Sylianco 1978
<i>S. typhimurium</i> TA1535	Reverse mutation	Not tested	-	San Augustin and Lim-Sylianco 1978
<i>S. typhimurium</i> TA1537	Reverse mutation	Not tested	-	San Augustin and Lim-Sylianco 1978

Table 2-6. Genotoxicity of Chloroform *In Vitro* (continued)

Species (test system)	End point	Results		Reference
		With activation	Without activation	
<i>Escherichia coli</i>	Reverse mutation	-	-	Kirkland et al. 1981
<i>Aspergillus nidulans</i>	Aneuploidia	+	Not tested	Crebelli et al. 1988
<i>Saccharomyces cerevisiae</i>	Reverse mutation	-	(+)	De Serres et al. 1981
<i>Schizosaccharomyces pombe</i>	Recombinations	-	(+)	Callen et al. 1980
Eukaryotic organisms:				
Mammalian cells:				
L5178Y mouse lymphoma cells	Forward mutation	+	-	Mitchell et al. 1988
Chinese hamster lung fibroblasts	Mutation at 8-azaquinone		-	Sturrock 1977
Chinese hamster ovary cells	Sister chromatid exchange		-	White et al. 1979
Human lymphocytes	Unscheduled DNA synthesis	-	-	Perocco and Prodi 1981
Human lymphocytes	Sister chromatid exchange	-	+	Morimoto and Koizumi 1983
Human lymphocytes	Sister chromatid exchange	-	-	Kirkland et al. 1981
Human lymphocytes	Chromosome aberrations		-	Kirkland et al. 1981

- = negative result; + = positive result; (+) = weakly positive; DNA = Deoxyribonucleic acid

## 2. HEALTH EFFECTS

**Cancer.** No studies were available regarding cancer in humans or animals after inhalation exposure to chloroform. Epidemiology studies suggest an association between chronic exposure to chlorinated drinking-water sources and increased incidences of colon cancer (Young et al. 1981), pancreatic cancer (Ijsselmuiden et al. 1982) and bladder cancer (Cantor et al. 1978; McGeehin et al. 1993; Zierler et al. 1988). However, numerous other potential toxicants known to exist in chlorinated drinking water may easily account for these effects.

The carcinogenic potential of chloroform has been tested in animal studies. A dose-related increase in the incidence of hepatomas was observed in mice exposed to chloroform for intermediate durations (Eschenbrenner and Miller 1945a). Chronic-duration exposure induced an increased incidence of renal adenoma and carcinoma in rats exposed to chloroform in drinking water (Jorgenson et al. 1985). Increased incidence of neoplastic nodules in the liver was observed in female Wistar rats ingesting chloroform in drinking water (Tumasonis et al. 1987). In addition, hepatocellular carcinoma was observed in B6C3F<sub>1</sub> mice given chloroform in oil by gavage (NCI 1976), and kidney tumors were observed in male ICI mice exposed by gavage to chloroform in toothpaste (Roe et al. 1979). The incidence of liver and kidney tumors in male and female rats given chloroform in a chronic-duration study has been reported (Dunnick and Melnick 1993; NCI 1976). While no hepatocellular or large intestine neoplasms were noted in either sex of rat, kidney tubular cell neoplasms were observed at 90 mg/kg/day and 180 mg/kg/day in male rats and at 200 mg/kg/day in female rats. In a another study by the same authors, using male and female mice dosed with similar amounts of chloroform, no kidney tubular cell neoplasms or large intestine neoplasms were reported in either sex of mice, while hepatocellular neoplasms were recorded in both sexes. In a similar study, Jorgenson et al. (1985) examined the carcinogenic effects of chloroform administered chronically (104 weeks) in drinking water to male Osborne-Mendel rats and female B6C3F<sub>1</sub> mice. While no treatment related enhancement of tumor formation was observed in mice, kidney tubular cell neoplasms were observed in male rats exposed to 160 mg/kg/day chloroform.

The data concerning mouse liver tumors are conflicting. In contrast to the increased incidence of liver tumors observed in B6C3F<sub>1</sub> mice exposed by gavage to chloroform in oil (NCI 1976), no increased incidence of liver tumors was observed in female B6C3F<sub>1</sub> mice exposed to chloroform in drinking water (Jorgenson et al. 1985). This result is consistent with the absence of liver tumor effects in four other strains of mice exposed by gavage to chloroform in toothpaste (Roe et al. 1979). In a pharmacokinetic study, chloroform was absorbed more slowly and to a lesser extent from corn oil than

## 2. HEALTH EFFECTS

water (Withey et al. 1983), suggesting that pharmacokinetic effects are not responsible for the differences in liver tumor responses. Nevertheless, data from historical controls indicate that corn oil alone is not responsible for the increased incidence of liver tumors (Jorgenson et al. 1985).

The corn oil vehicle effect on the induction of mouse liver neoplasms may be due to an interaction between the vehicle and chloroform (Bull et al. 1986; Jorgenson et al. 1985), possibly resulting in altered pharmacokinetics. Larson et al. (1994b) demonstrated that female B6C3F<sub>1</sub> mice developed increased hepatocyte toxicity after gavage dosing in oil with chloroform concentrations of 238 and 477 mg/kg/day for 4 days or 3 weeks (as determined by BrdU-labelling of hepatocytes). However, there was no increase in LI in the liver of the same strain of female mice administered up to 1,800 ppm in the drinking water for 4 days or 3 weeks. The actual doses for the mice administered at 1,800 ppm were 105 and 329 mg/kg/day, respectively. Other studies have shown similar intake dose difference due to vehicle effect (Jorgenson et al. 1985; NCI 1976). The difference in results are most likely due to the method of dosing and the vehicle used, both having effects on the pharmacokinetics of chloroform and hence the degree of hepatotoxicity (and perhaps the renal toxicity in males) that chloroform may induce in these mice. Gavaged animals typically receive a large dose of chloroform all at one time over a period of several days, while the animals in the drinking-water studies consume somewhat equal amounts of chloroform; however, it is consumed in small sips (Larson et al. 1994b). It seems clear that the design of the gavage studies inherently results in repeated and relatively massive doses of chloroform to the liver (and other susceptible cells) over a short period of time that likely overwhelm the liver defense mechanisms for chloroform detoxification, resulting in hepatotoxicity, cell death, or both. Conversely, drinking-water studies expose the liver to continuous, low doses of chloroform, resulting in detoxification, elimination, and few apparent signs of hepatocellular damage. Clearly, further studies that describe the differences in pharmacokinetics between dosing method (gavage as opposed to drinking water) and vehicle effects (oil as opposed to water) need to be performed to correctly estimate human risk to orally consumed chloroform.

The possible association between cell proliferation as a result of cytotoxicity and chemical carcinogenesis has been the subject of considerable debate (Melnick et al. 1996). Chemically induced cell proliferation does play an important role in the carcinogenic process; however, the relationship between induced cell proliferation and tumorigenesis is not a direct cause-and-effect relationship (Farber 1995). Based on short-term exposures studies (4, 7, or 21 days), Larson et al. (1994b) suggest that chloroform causes cancer by inducing cytotoxicity, followed by cell regeneration. However, a

## 2. HEALTH EFFECTS

review by Chiu et al. (1996), correlating chloroform-induced short-term and long-term cytotoxicity studies with cancer in target tissues, suggests that the mode of action of chloroform carcinogenesis can not be concluded with the currently available data.

There is a qualitative correlation between short-term toxicological end points of cytotoxicity and the occurrence of neoplasia in the liver of B6C3F<sub>1</sub> mice exposed to chloroform either by corn oil gavage or in the drinking water. However, the association between cytotoxicity and cancer is lacking in other test systems. For example, short-term cytotoxicity (4 days) was observed in the kidneys of B6C3F<sub>1</sub> mice (Larson et al. 1994d) without an observable increase in neoplasia in male B6C3F<sub>1</sub> mice exposed to chloroform in corn oil by gavage for 78 weeks at similar doses (NCI 1976). These data indicate that increased cell proliferation may not always be sufficient to cause increased tumor incidence.

Some studies suggest that the carcinogenic response in male rat kidneys (Jorgensen and Rushbrook 1980; Jorgensen et al. 1985) may not be mediated by a mechanism involving necrosis and regenerative cell proliferation. This observation is supported by the fact that chloroform exposure, by either drinking water or corn oil gavage, induced kidney neoplasia in male Osborne-Mendel rats without any reported short-term and long-term cytotoxicity. There was no treatment-related biochemical and microscopic/gross histopathological changes in the kidneys of the rats at 30, 60, or 90 days after receiving chloroform in the drinking water (Jorgensen and Rushbrook 1980). Neither necrosis nor tubular cell hyperplasia was found in the kidneys of male Osborne-Mendel rats treated with chloroform by gavage or drinking water in the 2-year bioassays (Jorgensen et al. 1985; NCI 1986).

In the liver bioassay for GGtase positive foci, chloroform had neither an initiating effect nor a promoting effect when administered in drinking water (Herren-Freund and Pereira 1987), but had a promoting effect of these loci initiated by diethylnitrosamine if given in a corn oil vehicle (Deml and Oesterle 1985); both studies were performed in rats. Moreover, chloroform enhanced the growth of experimentally inoculated tumors in mice (Cape1 et al. 1979). In contrast, chloroform had an inhibiting effect on the growth of tumors induced by known carcinogens (1,2-dimethylhydrazine and ethylnitrosurea) in rats (Daniel et al. 1989; Herren-Freund and Pereira 1987).

In epidemiologic studies, chloroform is not identified as the sole or primary cause of excess cancer rates, but it is one of many organic contaminants found in chlorinated drinking water, many of which are considered to have carcinogenic potential. These studies are often flawed by a lack of measured

## 2. HEALTH EFFECTS

chloroform concentrations in drinking water; lack of data concerning concentrations of other organics, limited information concerning personal drinking-water consumption, long latency periods, and effects of migration, making it difficult to quantify exposure. Although human data suggest a possible increased risk of cancer from exposure to chloroform in chlorinated drinking water, the data are too weak to draw a conclusion about the carcinogenic potential of chloroform in humans. Based on animal studies, chloroform has been classified as a probable human carcinogen by EPA (IRIS 1995), as a possible human carcinogen by IARC (1987), and as a substance that may reasonably be anticipated to be carcinogenic in humans (NTP 1989).

### 2.6 BIOMARKERS OF EXPOSURE AND EFFECT

Biomarkers are broadly defined as indicators signaling events in biologic systems or samples. They have been classified as markers of exposure, markers of effect, and markers of susceptibility (NAS/NRC 1989).

Due to a nascent understanding of the use and interpretation of biomarkers, implementation of biomarkers as tools of exposure in the general population is very limited. A biomarker of exposure is a xenobiotic substance or its metabolite(s), or the product of an interaction between a xenobiotic agent and some target molecule(s) or cell(s) that is measured within a compartment of an organism (NAS/NRC 1989). The preferred biomarkers of exposure are generally the substance itself or substance-specific metabolites in readily obtainable body fluid(s) or excreta. However, several factors can confound the use and interpretation of biomarkers of exposure. The body burden of a substance may be the result of exposures from more than one source. The substance being measured may be a metabolite of another xenobiotic substance (e.g., high urinary levels of phenol can result from exposure to several different aromatic compounds). Depending on the properties of the substance (e.g., biologic half-life) and environmental conditions (e.g., duration and route of exposure), the substance and all of its metabolites may have left the body by the time samples can be taken. It may be difficult to identify individuals exposed to hazardous substances that are commonly found in body tissues and fluids (e.g., essential mineral nutrients such as copper, zinc, and selenium). Biomarkers of exposure to chloroform are discussed in Section 2.6.1.

Biomarkers of effect are defined as any measurable biochemical, physiologic, or other alteration within an organism that, depending on magnitude, can be recognized as an established or potential health

## 2. HEALTH EFFECTS

impairment or disease (NAS/NRC 1989). This definition encompasses biochemical or cellular signals of tissue dysfunction (e.g., increased liver enzyme activity or pathologic changes in female genital epithelial cells), as well as physiologic signs of dysfunction such as increased blood pressure or decreased lung capacity. Note that these markers are often not substance specific. They also may not be directly adverse, but can indicate potential health impairment (e.g., DNA adducts). Biomarkers of effects caused by chloroform are discussed in Section 2.6.2.

A biomarker of susceptibility is an indicator of an inherent or acquired limitation of an organism's ability to respond to the challenge of exposure to a specific xenobiotic substance. It can be an intrinsic genetic or other characteristic or a pre-existing disease that results in an increase in absorbed dose, biologically effective dose, or target tissue response. If biomarkers of susceptibility exist, they are discussed in Section 2.7, Populations That Are Unusually Susceptible.

### **2.6.1 Biomarkers Used to Identify or Quantify Exposure to Chloroform**

Chloroform concentrations measured in tissue and/or air samples can not be currently be used as specific biomarkers for chloroform exposure; however, they may indicate exposure to chloroform or other halogenated compounds that have undergone metabolism to chloroform. Methods for measuring chloroform in biological fluids, tissues, and exhaled breath are available; however, there is relatively little quantitative information relating monitored chloroform levels in tissues or fluids to exposure. The presence of chloroform or its metabolites in biological fluids and tissues may result from the metabolism of other chlorinated hydrocarbons; thus, elevated tissue levels of chloroform or its metabolites may reflect exposure to other compounds. The relationship between chloroform concentration in inspired air and resulting blood chloroform levels is the most well defined measure of exposure due to the extensive use of chloroform as a surgical anesthetic. A mean arterial blood concentration of 9.8 mg/dL (range 7-16.6 mg/dL) was observed among 10 patients receiving chloroform anesthesia at an inspired air concentration of 8,000-10,000 ppm (Smith et al. 1973). Monitoring of blood levels in workers experiencing toxic jaundice due to chloroform exposure revealed that when workroom air concentrations were estimated to be >400 ppm, the blood samples of 13 workers with jaundice were 0.10-0.3 µg/100 mL blood (Phoon et al. 1983). In another group of 18 workers with toxic hepatitis, blood samples revealed chloroform in some but not all workers, and workroom air contained 14.4-50.4 ppm on various days. These data suggest an association between



## 2. HEALTH EFFECTS

increased blood concentrations and increased exposure concentrations, but the blood levels varied too greatly to establish a direct quantitative relationship.

Environmental exposure to chloroform in humans probably represents a combination of inhalation exposure (from the air polluted with volatile halogenated hydrocarbons) and oral exposure (from chlorinated water sources), in addition to a dermal absorption route for chloroform from contaminated water sources (from showering, bathing, or swimming). The chloroform levels detected in human blood varied according to geographical areas. Chloroform levels ranged from 13 to 49  $\mu\text{g/L}$  in serum samples taken from 10 individuals in Florida (Peoples et al. 1979). The level of environmental exposure was not reported. The mean blood chloroform concentration was 1.5  $\mu\text{g/L}$  in blood samples taken from 250 individuals in Louisiana; exposure levels were not reported (Antoine et al. 1986).

Chloroform was found in breath samples from large cohorts of people from New Jersey, North Carolina, and North Dakota (Wallace et al. 1987a). The levels of chloroform in breathing zone (personal) air were consistently higher than outdoor concentrations and correlated with chloroform concentrations in the exhaled breath samples. Some activities such as visiting the dry cleaners (an industry associated with high chloroform levels) or showering were associated with increased chloroform breath levels (Jo et al. 1990a, 1990b; Wallace et al. 1989). Chloroform was detected in 7 of 42 samples of human milk collected in 4 geographical areas in the United States (Pellizzari et al. 1982).

Tissue levels of chloroform obtained at autopsy reflected environmental exposure levels in other studies. The levels ranged from 20 to 49  $\mu\text{g/kg}$  of chloroform from adipose tissue extracted into hexane from samples taken from 10 individuals in Florida (Peoples et al. 1979). In 30 autopsy cases in Germany, the adipose tissue contained a mean of 23.4  $\mu\text{g/kg}$  wet tissue; 24.8  $\mu\text{g/kg}$  perinephric fat; 10.8  $\mu\text{g/kg}$  liver tissue; 9.9  $\mu\text{g/kg}$  lung tissue; and 10  $\mu\text{g/kg}$  muscle tissue (Alles et al. 1988). The maximum chloroform content increased with age and was not dependent on the volume of fat in the tissues.

No correlation has been made between the exact environmental levels of chloroform and the amount of chloroform in the exhaled breath or in the blood. Furthermore, chloroform also can be detected in the breath after exposure to carbon tetrachloride and other chlorinated hydrocarbons (Butler 1961). Therefore, chloroform levels cannot be used as reliable biomarkers of exposure to this chemical.

## 2. HEALTH EFFECTS

### 2.6.2 Biomarkers Used to Characterize Effects Caused by Chloroform

The primary targets of chloroform toxicity are the central nervous system, liver, and kidney. The signs and symptoms of central nervous system effects (e.g., dizziness, fatigue, headache) are easily recognized. Monitoring liver and kidney effects induced by exposure to low levels of chloroform requires the testing of organ functions. Liver effects are commonly detected by monitoring for elevated levels of liver enzymes in the serum or testing for sulfobromophthalein retention. Urinalysis and measurements of BUN and  $\beta$ -2-microglobulin are used to detect abnormalities in kidney function. Because many toxic chemicals can cause adverse liver and kidney effects, these tests are not specific for chloroform. No specific biomarkers used to characterize effects caused specifically by chloroform were located.

For more information on biomarkers for renal and hepatic effects of chemicals see *ATSDR/CDC Subcommittee Report on Biological Indicators of Organ Damage* (1990) and for information on biomarkers for neurological effects see OTA (1990).

### 2.7 INTERACTIONS WITH OTHER CHEMICALS

The interactions of chloroform with other chemicals are an issue of great importance; as with many chemicals, exposure to chloroform alone seldom occurs. This is especially true when considering exposure to chlorinated water, which usually contains other trihalomethanes and may contain other potential toxicants.

Clinical reports of patients who underwent chloroform anesthesia indicated that premeditation with morphine caused serious respiratory depression when chloroform was co-administered. Thiopentone (thiopental Na, an ultra-short-acting barbiturate anesthetic) was associated with increased incidences of hypotension in chloroform-anesthetized patients (Whitaker and Jones 1965).

Several animal studies indicate that chloroform interacts with other chemicals within the organism. The lethal and hepatotoxic effects of chloroform were increased by dicophane (DDT) (McLean 1970) and phenobarbital (a long-acting barbiturate) in rats (Ekstrom et al. 1988; McLean 1970; Scholler 1970). Increased hepatotoxic and nephrotoxic effects were observed after interaction with ketonic solvents and ketonic chemicals in rats (Hewitt and Brown 1984; Hewitt et al. 1990) and in mice

## 2. HEALTH EFFECTS

(Cianflone et al. 1980; Hewitt et al. 1979). The hepatotoxicity of chloroform was also enhanced by co-exposure to carbon tetrachloride in rats (Harris et al. 1982) and by co-exposure to ethanol in mice (Kutob and Plaa 1962). Furthermore, ethanol pretreatment in rats enhanced chloroform-induced hepatotoxicity (Wang et al. 1994) and increased the *in vitro* metabolism of chloroform (Sato et al. 1981).

A mixture of cadmium and chloroform potentiated the cytotoxicity of each in *in vitro* experiments in rat hepatocytes (Stacey 1987a, 1987b). In contrast, mirex did not increase chloroform toxicity in mice (Hewitt et al. 1979). Disulfiram, an inhibitor of microsomal enzymes, decreases the hepatotoxicity of chloroform (Masuda and Nakayama 1982; Scholler 1970). Diethyldithiocarbamate and carbon disulfide pretreatment also protect against chloroform hepatotoxicity (Gopinath and Ford 1975; Masuda and Nakayama 1982, 1983), presumably by inhibiting microsomal enzymes. In general, chloroform toxicity can be influenced by chemicals that alter microsomal enzyme activity or hepatic GSH levels.

The role that dichloroacetate (DCA) and trichloroacetate (TCA) play in chloroform toxicity was studied in rats (Davis 1992). TCA and DCA are formed in conjunction with chloroform during the chlorination of drinking water; therefore, animals drinking chlorinated water may be exposed to all three compounds simultaneously. It was found that DCA increases the hepatotoxicity and nephrotoxicity of chloroform in rats, that TCA increases the nephrotoxicity of chloroform, and that these effects were gender-specific, occurring mainly in females. The effects of monochloroacetate (MCA) on chloroform toxicity has also been investigated, with the combination (MCA + chloroform) shown to have toxic effects on the liver and kidneys of rats (Davis and Bemdt 1992). The effect of chloroform and other organic halides (i.e., dichlorobromomethane) on intrauterine growth retardation has also been explored (Kramer et al. 1992).

Ikatsu and Nakajima (1992) studied the effect of low-dose inhalation of chloroform with or without co-exposure to carbon tetrachloride on hepatotoxicity when rats were or were not previously exposed to ethanol. Groups of control or ethanol-pretreated rats inhaled 0, 50, or 100 ppm chloroform alone; 0, 25, or 50 ppm chloroform with 5 ppm carbon tetrachloride; or 0, 10, 25, or 50 ppm chloroform with 10 ppm carbon tetrachloride. Exposures to either 50 or 100 ppm of chloroform alone did not significantly change SGOT, SGPT, liver, or serum malondialdehyde (MDA) concentrations. In the rats pretreated with ethanol, SGOT and SGPT levels were significantly elevated above control animals at 100 ppm chloroform and SGOT levels were increased at 50 ppm chloroform as well. There was no

## 2. HEALTH EFFECTS

change in either serum or liver concentrations of MDA in either exposure group. Liver triglycerides and GSH levels were significantly elevated above those of control animals for both exposure levels for animals not pretreated with ethanol; however, overall liver weights were elevated at only 100 ppm chloroform. In rats pretreated with ethanol, there was no significant change in liver triglyceride concentrations at either dose; however, liver GSH and liver weights were significantly elevated above control at both exposure concentrations. In chloroform and carbon tetrachloride treated rats not pretreated with ethanol, elevations in SGOT (10 ppm  $CCl_4$  plus 10 and 50 ppm  $CHCl_3$ ), SGPT (5 ppm  $CCl_4$  plus 50 ppm  $CHCl_3$ , 10 ppm  $CCl_4$  plus 25 ppm  $CHCl_3$ , and plasma MDA (10 ppm  $CCl_4$  plus 10, 25, and 50 ppm  $CHCl_3$ ) were observed. In chloroform and carbon tetrachloride-treated rats pretreated with ethanol, elevations in SGOT (all doses), SGPT (all doses except 5 ppm  $CCl_4$  + 25 ppm  $CHCl_3$ ), liver MDA (all doses), and plasma MDA (5 and 10 ppm  $CCl_4$  + 50 ppm  $CHCl_3$ , 10 ppm  $CCl_4$  + 25 ppm  $CHCl_3$ ) were observed. In chloroform and carbon tetrachloride treated rats not pretreated with ethanol, elevations in liver triglyceride (all doses) and GSH (5 ppm  $CCl_4$  + 50 ppm  $CHCl_3$ , 10 ppm  $CCl_4$  + 10 and 50 ppm  $CHCl_3$ ) were observed. In chloroform and carbon tetrachloride treated rats pretreated with ethanol, elevations in liver triglyceride (all chloroform doses at 10 ppm  $CCl_4$ ) and GSH (all doses except 5 ppm  $CCl_4$  + 25 ppm  $CHCl_3$ ) were observed. The results suggest that chloroform enhances carbon tetrachloride-induced hepatotoxicity.

### 2.8 POPULATIONS THAT ARE UNUSUALLY SUSCEPTIBLE

A susceptible population will exhibit a different or enhanced response to chloroform than will most persons exposed to the same level of chloroform in the environment. Reasons may include genetic makeup, age, health and nutritional status, and exposure to other toxic substances (e.g., cigarette smoke). These parameters may result in reduced detoxification or excretion of chloroform, or compromised function of target organs affected by chloroform. Populations who are at greater risk due to their unusually high exposure to chloroform are discussed in Section 5.6, Populations With Potentially High Exposure.

Since the liver and kidney are the two main organs responsible for chloroform metabolism, individuals who have hepatic or renal impairment may be more susceptible to chloroform toxicity; one such population would be those who abuse alcohol (Wang et al. 1994; Kutob and Plaa 1962). Also, exhaustion and starvation may potentiate chloroform hepatotoxicity, as indicated in some human clinical reports (Royston 1924; Townsend 1939) and in animal studies (Ekstrom et al. 1988; McMartin

## 2. HEALTH EFFECTS

et al. 1981). Animal studies indicate that male mice and rats may be more susceptible to the lethal and renal effects of chloroform than female mice and rats (Deringer et al. 1953; Torkelson et al. 1976). The greater susceptibility of adult male animals is associated with testosterone levels in the animals (Deringer et al. 1953). Evidence also exists for age-related effects; young male mice were less susceptible to the lethal effects of chloroform compared to adult males (Deringer et al. 1953). Kimura et al. (1971) noted similar differences between young and old adult rats, but also found that chloroform was significantly more toxic in 14-day-old rats than in adult rats. Whether or not these subpopulations in humans would be more susceptible than their respective counterparts is not presently known.

### 2.9. METHODS FOR REDUCING TOXIC EFFECTS

This section will describe clinical practice and research concerning methods for reducing toxic effects of exposure to chloroform. However, because some of the treatments discussed may be experimental and unproven, this section should not be used as a guide for treatment of exposures to chloroform. When specific exposures have occurred, poison control centers and medical toxicologists should be consulted for medical advice. The following texts provide specific information about treatment following exposures to chloroform:

Ellenhorn, MJ and Barceloux, DG, (eds.) (1988). *Medical Toxicology: Diagnosis and Treatment of Human Poisoning*. Elsevier Publishing, New York, NY., pp. 972-974.

Dreisback, RH, (ed.) (1987). *Handbook of Poisoning*. Appleton and Lange, Norwalk, CT.

Haddad, LM and Winchester, JF, (eds.) (1990). *Clinical Management of Poisoning and Drug Overdose*. 2nd edition, WB Saunders, Philadelphia, PA.

Aaron, CK and Howland, MA (eds.) (1994). *Goldfrank's Toxicologic Emergencies*. Appleton and Lange, Norwalk, CT.

#### 2.9.1 Reducing Peak Absorption Following Exposure

Human exposure to chloroform may occur by inhalation, ingestion, or by dermal contact. General recommendations for reducing absorption of chloroform include removing the exposed individual from the contaminated area and removing the contaminated clothing. If the eyes and skin were exposed, they should be flushed with water. In order to reduce absorption of ingested chloroform, emesis may

## 2. HEALTH EFFECTS

be considered unless the patient is comatose, is convulsing, or has lost the gag reflex. Controversy exists concerning use of emesis because of the rapid onset of central nervous system depression, the risk of aspiration of stomach contents into the lungs, and the relative ineffectiveness of this method. In comatose patients with absent gag reflexes, an endotracheal intubation may be performed in advance to reduce the risk of aspiration pneumonia. Gastric lavage may also be used.

### 2.9.2 Reducing Body Burden

Chloroform is not stored to any appreciable extent in the human body and is mostly metabolized to phosgene and eventually CO<sub>2</sub> (see Section 2.3); however, some chloroform may be stored in fat depots in the body. The half-life of chloroform in humans has been calculated to be 7.9 hours following inhalation exposure (Gordon et al. 1988). Furthermore, an oral-exposure study found most of the chloroform dose being eliminated within 8 hours postexposure (Fry et al. 1972). Hepatic and pulmonary first-pass effect was reported in humans (Chiou 1975).

Despite a relatively fast clearance of chloroform from the body, toxic effects may develop in exposed individuals. No method is commonly practiced to enhance the elimination of the absorbed dose of chloroform. Although there is evidence that ethanol pretreatment of rats can increase the in vitro metabolism of chloroform (Sato et al. 1981), such treatment would not be recommended (Kutob and Plaa 1962) because it would increase the toxicity of chloroform and it is a very poor practice generally.

### 2.9.3 Interfering with the Mechanism of Action for Toxic Effects

Target organs of chloroform toxicity are the central nervous system, liver, and kidneys (see Section 2.2). Respiratory, cardiovascular, and gastrointestinal toxic effects have also been reported. Studies in animals also indicated that chloroform exposure may induce reproductive and developmental effects and cause cancer. Several studies investigated the possible mechanism for chloroform-induced toxicity (see Section 2.5). Proposed mechanisms of chloroform toxicity and potential mitigations based on these mechanisms are discussed below. The potential mitigation techniques mentioned are all experimental.

## 2. HEALTH EFFECTS

One of the possible mechanisms of chloroform toxicity is thought to be linked to its high lipid solubility and its ability to bind covalently to lipids (Testai et al. 1987). For example, neurotoxic and respiratory effects of chloroform may be due to the interaction of chloroform with gangliosides in neuronal membranes (Harris and Groh 1985) and phospholipids in the surfactant monolayer of the lower respiratory tract (Enhorning et al. 1986), respectively. Another proposed reaction of chloroform and lipids would result in the formation of conjugated dienes which are indicative of lipid peroxidation (De Groot and Noll 1989). Some authors reported that conjugated dienes may play a key role in the hepatotoxicity induced by haloalkanes (Comporti 1985; Recknagel et al. 1982). Others, however, argue that lipid peroxidation alone is not responsible for all changes found in the liver following chloroform exposure (Brown et al. 1974b; Lavigne and Marchand 1974). Instead, it was proposed that the mechanism of chloroform-induced liver and kidney toxicity involved metabolism to the reactive intermediate, phosgene, which binds to proteins of the endoplasmic reticulum (Pohl et al. 1980a, 1980b). While this is true in the rat, it has not been established in other species, including humans.

The toxicity of chloroform is increased by inducers of cytochrome P-450 such as phenobarbital (Scholler 1970). The involvement of cytochrome P-450 is further supported by the finding that disulfiram (Scholler 1970) and methoxsalen (Letteron et al. 1987), both inhibitors of microsomal enzymes, decreased the liver injury caused by chloroform in rats and mice, respectively. In addition, pretreatment with diethyldithiocarbamate and carbon disulfide protected mice against chloroform hepatotoxicity as indicated by biochemical and histopathological results (Gopinath and Ford 1975; Masuda and Nakayama 1982, 1983). Similarly, pretreatment of mice with methoxsalen (Letteron et al. 1987) and piperonyl butoxide (Kluwe and Hook 1981) reduced the chloroform-induced nephrotoxicity. Further research to determine which isozymes of P-450 are involved in metabolism to the more harmful metabolite, phosgene, as well as which isozymes are involved in enhancing the elimination of chloroform, could lead to the development of strategies designed to selectively inhibit specific P-450 isozymes, and thus reduce the toxic effects of chloroform.

Administration of chloroform to laboratory animals resulted in the depletion of renal GSH, indicating that GSH reacts with reactive intermediates, thus reducing the kidney damage otherwise caused by the reaction of these intermediates with tissue MMBs (Hook and Smith 1985; Smith and Hook 1983, 1984; Smith et al. 1984). Similarly, chloroform treatment resulted in the depletion of hepatic GSH and alkylation of MMBs (Docks and Krishna 1976). Other studies demonstrated that sulfhydryl compounds such as L-cysteine (Bailie et al. 1984) and reduced GSH (Kluwe and Hook 1981) may

## 2. HEALTH EFFECTS

provide protection against nephrotoxicity induced by chloroform. The sulfhydryl compound N-acetylcysteine is an effective antidote for poisoning by acetaminophen, which, like chloroform, depletes GSH and produces toxicity by reactive intermediates.

All mitigations of the chloroform-induced toxicity cited above are experimental. Further studies would be needed for implications of any of these methods to humans.

### 2.10 ADEQUACY OF THE DATABASE

Section 104(i)(5) of CERCLA directs the Administrator of ATSDR (in consultation with the Administrator of EPA and agencies and programs of the Public Health Service) to assess whether adequate information on the health effects of chloroform is available. Where adequate information is not available, ATSDR, in conjunction with the National Toxicology Program (NTP), is required to assure the initiation of a program of research designed to determine the health effects (and techniques for developing methods to determine such health effects) of chloroform.

The following categories of possible data needs have been identified by a joint team of scientists from ATSDR, NTP, and EPA. They are defined as substance-specific informational needs that if met would reduce or eliminate the uncertainties of human health assessment. This definition should not be interpreted to mean that all data needs discussed in this section must be filled. In the future, the identified data needs will be evaluated and prioritized, and a substance-specific research agenda will be proposed.

#### 2.10.1 Existing Information on Health Effects of Chloroform

The existing data on health effects of inhalation, oral, and dermal exposure of humans and animals to chloroform are summarized in Figure 2-6. The purpose of this figure is to illustrate the existing information concerning the health effects of chloroform. Each dot in the figure indicates that one or more studies provide information associated with that particular effect. The dot does not necessarily imply anything about the quality of the study or studies, nor should missing information in this figure be interpreted as a “data need.” A data need, as defined in ATSDR’s *Decision Guide for Identifying Substance-Specific Data Needs Related to Toxicological Profiles* (ATSDR 1989), is substance-specific information necessary to conduct comprehensive public health assessments. Generally, ATSDR



## 2. HEALTH EFFECTS

defines a data gap more broadly as any substance-specific information missing from the scientific literature.

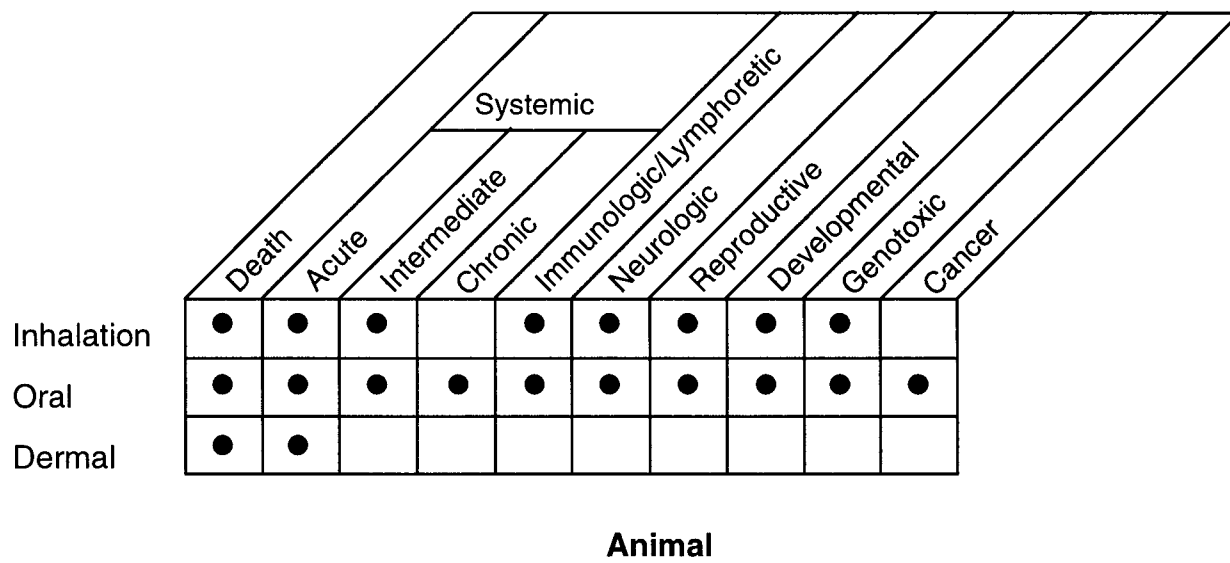
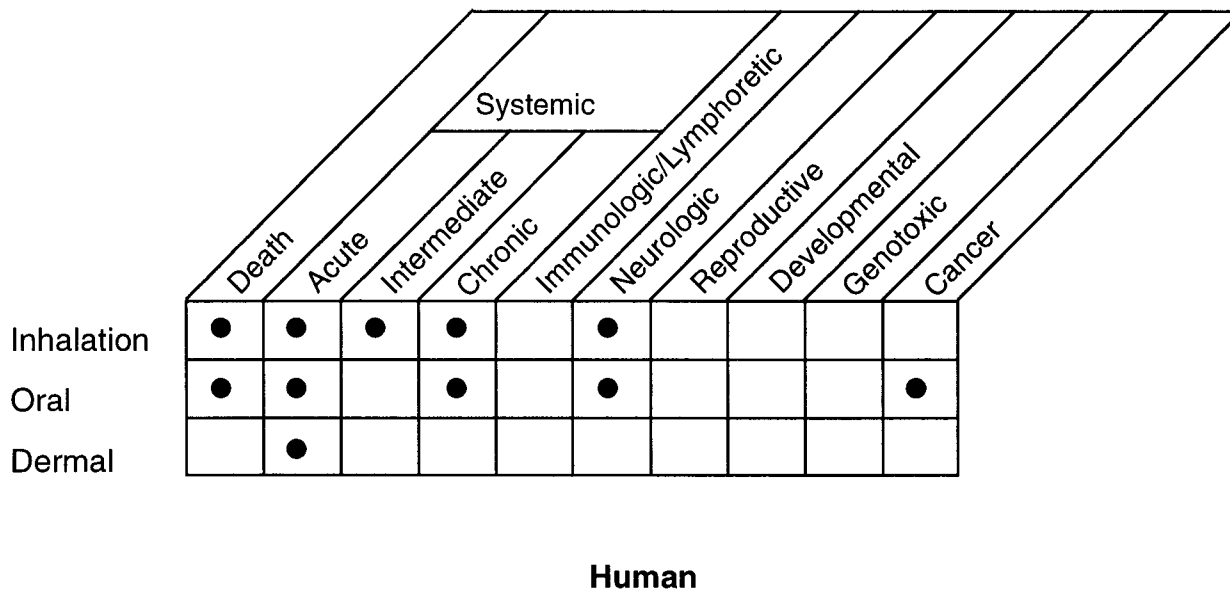
As seen from Figure 2-6, information is available regarding death, systemic effects, and neurological effects in humans after inhalation and oral exposure to chloroform. In addition, information is available regarding carcinogenic effects in humans after oral exposure to chlorinated drinking water. Limited information is available regarding dermal effects in humans after exposure to chloroform.

Inhalation and oral studies in animals provide data on death, systemic effects after acute- and intermediate-duration exposure, immunological effects, neurological effects, developmental effects, reproductive effects, and genotoxic effects. Information is available regarding systemic effects and carcinogenic effects in animals after oral exposure to chloroform. The carcinogenic effects after oral exposure is inconsistent and not totally conclusive. In addition, data regarding death and acute systemic effects in animals after dermal exposure to chloroform were located in the available literature.

### 2.10.2 Identification of Data Needs

**Acute-Duration Exposure.** Clinical reports indicate that the central nervous system, cardiovascular system, stomach, liver, and kidneys in humans are target organs of chloroform toxicity after inhalation and oral exposure to chloroform (Schroeder 1965; Smith et al. 1973; Whitaker and Jones 1965). These findings are supported by results obtained from acute inhalation and oral-exposure studies in animals in which target organs identical to those observed in human studies (central nervous

**Figure 2-6. Existing Information on Health Effects of Chloroform**



● Existing Studies

## 2. HEALTH EFFECTS

system, liver, and kidney) were identified (Culliford and Hewitt 1957; Jones et al. 1958; Lehmann and Flury 1943; Lundberg et al. 1986; Moore et al. 1982). The data are sufficient to derive an MRL for acute oral exposure. An acute inhalation MRL was derived based on a NOAEL for hepatic effects in mice (Larson et al. 1994c). Lethality studies were conducted in rats and mice after acute inhalation exposure (Deringer et al. 1953; Gehring 1968; Lundberg et al. 1986; Smyth et al. 1962). Similarly, lethal doses were identified after single oral exposure in rats and mice (Bowman et al. 1978; Chu et al. 1982b; Jones et al. 1958; Kimura et al. 1971; Smyth et al. 1962). Information regarding dermal effects in humans and animals after exposure to chloroform is limited. Degenerative changes in the kidney tubules of rabbits were reported in one dermal study (Torkelson et al. 1976). Toxicokinetic data regarding dermal exposure are very limited; however, there is evidence that chloroform can be absorbed through the skin (Tsuruta 1975). Due to its lipophilic quality after dermal exposure, chloroform is likely to be distributed in the organism in patterns similar to those for inhalation and oral exposure. Information regarding acute dermal exposure in rodents would be useful to identify target organs and threshold levels of chloroform toxicity. Several *in vitro* skin models are available that would be adequate for describing the absorption of chloroform through the skin and the effects that differing concentrations of chloroform would have on skin histology.

**Intermediate-Duration Exposure.** An occupational study suggests that the liver is a target organ of chloroform toxicity after inhalation exposure of intermediate duration (Phoon et al. 1983). No data were located regarding intermediate-duration oral and dermal exposure in humans. Several studies were located regarding chloroform toxicity in animals after oral exposure (including 3 90-day studies in rats, 3 90-day studies in mice, and a  $\geq 6$ -week oral study in dogs) (Bull et al. 1986; Chu et al. 1982a, 1982b; Heywood et al. 1979; Jorgenson and Rushbrook 1980; Klaunig et al. 1986; Munson et al. 1982; Palmer et al. 1979); fewer data were located regarding inhalation exposure (Torkelson et al. 1976), and no data were located regarding dermal exposure. In animals, the target organs for chloroform toxicity were identified as the central nervous system, liver, and kidneys.

An intermediate-duration oral MRL was derived based on liver effects in dogs (Heywood et al. 1979). An intermediate-duration inhalation MRL was derived based on toxic hepatitis which occurred in humans (Phoon et al. 1983). Pharmacokinetic data regarding dermal exposure to chloroform are limited, but it is known that chloroform can be absorbed through the skin. Intermediate-duration dermal studies in animals would provide information about chloroform toxicity via this exposure route.

## 2. HEALTH EFFECTS

The information would be useful for populations living at or near hazardous waste sites, who may be exposed to chloroform for intermediate durations.

**Chronic-Duration Exposure and Cancer.** Information regarding chronic-exposure inhalation exposure to chloroform in humans is limited to occupational studies (Bomski et al. 1967; Challen et al. 1958). The liver and central nervous system are target organs of chloroform toxicity. Regarding chronic-duration oral exposure in humans, limited information is available from a case study reporting hematological, hepatic, and renal effects in an individual who used a cough medicine containing chloroform for 10 years (Wallace 1950) and from a follow-up study of individuals who used a mouthwash containing chloroform for 15 years (De Salva et al. 1975). Animal data indicate that the central nervous system, liver, and kidneys are target organs of chloroform toxicity after chronic oral exposure (Heywood et al. 1979; Jorgenson et al. 1985; NCI 1976; Roe et al. 1979; Tumasonis et al. 1985, 1987). The data are sufficient to derive a chronic oral MRL. No studies were located regarding chloroform toxicity in humans and animals after dermal exposure to chloroform and in animals after inhalation exposure to chloroform. Considering the similar pattern of chloroform toxicity after inhalation and oral exposures for acute and intermediate durations, similar target organs in animals after chronic inhalation exposure to chloroform may be predicted. Nonetheless, studies designed to assess the chronic toxicity of chloroform in animals after inhalation and dermal exposure would be useful to establish dose-response relationships. This information is important to humans occupationally exposed or exposed to contaminated air, water, or soil at or near hazardous waste sites.

Epidemiology studies suggest a possible association between chloroform in drinking water and cancer risk. Increased incidences of colon and bladder cancer were identified in separate populations exposed to chlorinated water. However, as mentioned before, other toxic compounds have also been identified in chlorinated drinking water, making the role of chloroform in cancer induction questionable. Studies in rats and mice indicate that oral exposure to chloroform causes cancer (Jorgenson et al. 1985; NCI 1976; Roe et al. 1979; Tumasonis et al. 1985, 1987); however, some of these studies utilized gavage dosing instead of drinking water. No data were located regarding carcinogenicity in humans and animals following inhalation and dermal exposure to chloroform. Nonetheless, pharmacokinetic data indicate similar toxicokinetics of chloroform after inhalation and oral exposure; therefore, similar targets for carcinogenic effects may be predicted. Data were located suggesting different effects of chloroform depending on the vehicle and method of oral administration. Chloroform in corn oil administered by gavage caused an increased incidence of liver tumors (NCI 1976) while

## 2. HEALTH EFFECTS

administration of the same dose in drinking water did not (Jorgenson et al. 1985). It was demonstrated, however, that chloroform uptake is much slower from the oil vehicle (Withey et al. 1983). Therefore, the higher cancer incidence cannot be explained merely by the levels of chloroform in tissues. Furthermore, chloroform acted as a promoter rather than an initiator of preneoplastic foci in a rat liver bioassay (Deml and Oesterle 1985). In contrast, some studies indicate that chloroform inhibits the growth of tumors induced by known carcinogens (Daniel et al. 1989; Herren-Freund and Pereira 1987). Animal studies also suggest an epigenetic mechanism for the carcinogenicity of chloroform. Because of these differences, further studies on the possible mechanism of chloroform carcinogenicity would be useful.

**Genotoxicity.** Chloroform has been tested for genotoxicity in several *in vitro* and *in vivo* experiments. Its potency to induce mutations seems to be weak. No induction of reverse mutations was observed in prokaryotic systems (Gocke et al. 1981; Kirkland et al. 1981; San Augustin and Lim-Sylianco 1978; Simmon et al. 1977; Uehleke et al. 1977; Van Abbe et al. 1982; Vat-ma et al. 1988). Mixed results were obtained in the induction of mutations in human lymphocytes and Chinese hamster cells *in vitro* (Kirkland et al. 1981; Mitchell et al. 1988; Peroccio and Prodi 1981; White et al. 1979). Nonetheless, an increase in sperm anomalies and sister chromatid exchanges in the bone marrow of rodents was observed after *in vivo* exposure (Land et al. 1979, 1981; Morimoto and Koizumi 1983). Cytogenetic analysis of peripheral lymphocytes from exposed individuals would provide useful information about the ability of chloroform to induce mutations in-humans if a suitable population can be identified.

**Reproductive Toxicity.** No information was located regarding reproductive effects in humans exposed to chloroform via any route or in animals exposed by the dermal route. Increased resorptions were observed in rats and mice after inhalation exposure to chloroform during gestation (Murray et al. 1979; Schwetz et al. 1974) and in rats and rabbits after oral exposure (Thompson et al. 1974). In addition to effects in dams, abnormal sperm were found in mice after inhalation exposure (Land et al. 1979, 1981). Furthermore, exposure-related gonadal atrophy was observed in both sexes of rats following oral exposure to chloroform (Palmer et al. 1979). The results suggest that reproductive organs are a target of chloroform toxicity in animals; however, some inhalation and oral studies in animals do not report any effects. More studies assessing the reproductive function in animals would be useful for the purpose of extrapolating the data to human exposure.

## 2. HEALTH EFFECTS

**Developmental Toxicity.** Only one study was located regarding developmental effects in humans exposed to chloroform via an oral route. Animal data indicate that chloroform can cross the placenta. Fetotoxicity effects (decreased birth weight, decreased fetal crown-rump length, increased resorptions) and teratogenicity (acaudate fetuses with imperforate anus, cleft palates) were observed in rats and mice after inhalation exposure to chloroform (Murray et al. 1979; Schwetz et al. 1974). Oral exposure to chloroform-induced fetotoxicity in rats and rabbits (Ruddick et al. 1983; Thompson et al. 1974). Degeneration of the epididymal ductal epithelium (not affecting the fertility) was observed in mice in the F<sub>1</sub> generation in a 2-generation oral reproductive study (Gulati et al. 1988). No information is available regarding the developmental toxicity of chloroform after dermal exposure. More data regarding developmental toxicity both in humans and in experimental animals (especially after oral and dermal exposure) would be useful to identify the possible risk for humans.

**Immunotoxicity.** No data were located regarding immunological effects in humans after inhalation, oral, or dermal exposure to chloroform. The data obtained from animal studies are limited to one inhalation study in mice and three oral studies in rats and mice (Aranyi et al. 1986; Chu et al. 1982b; Munson et al. 1982). Depressed humoral and cell-mediated immunity were detected; however, the chloroform-induced changes were more serious in the acute exposure study than in the intermediateduration study, indicating that the changes may be transient. Studies regarding skin sensitization with chloroform were not performed. A battery of immune function tests has not been performed in humans or in animals, but would provide helpful information to support or refute the limited evidence for chloroform immunotoxicity.

**Neurotoxicity.** The central nervous system is a target organ for chloroform toxicity in humans after inhalation and oral exposure. The neurotoxic effect is well documented in studies of patients exposed to chloroform via anesthesia (Featherstone 1947; Smith et al. 1973; Whitaker and Jones 1965) or of individuals who intentionally and accidentally ingested the chemical (Piersol et al. 1933; Schroeder 1965; Storms 1973). Lower chloroform doses produced neurological effects during occupational exposure (Challen et al. 1958). Similarly, neurotoxicity is reported in animal studies involving inhalation and oral exposure to chloroform (Bowman et al. 1978; Jones et al. 1958; Lehmann and Flury 1943). A battery of neurobehavioral tests was conducted in mice after oral exposure to chloroform (Balster and Borzelleca 1982). No data were located regarding chloroform neurotoxicity in humans or animals after dermal exposure to chloroform. Animal studies involving dermal exposure to chloroform would be useful for risk assessment of occupational exposure. Continued research on the

## 2. HEALTH EFFECTS

toxicity of inhaled and dermally absorbed chloroform in humans when exposed to water sources containing elevated concentrations of chloroform during showering would also be useful. More information regarding the mechanism of chloroform-induced neurotoxicity and structural alterations produced in the central nervous system would be helpful.

**Epidemiological and Human Dosimetry Studies.** Populations may be exposed to chloroform in the workplace, near hazardous waste sites containing chloroform, from chlorinated water, and from various consumer products that contain chloroform. Limited information was obtained from occupational studies reporting central nervous system and liver effects in exposed workers (Bomski et al. 1967; Challen et al. 1958; Phoon et al. 1983). Reliable dosimetry data correlating occupational exposure with signs of toxic effects would be useful. Epidemiology studies suggest an association between elevated chloroform levels in drinking water and colon, rectal, and bladder cancer in humans (Alavanja et al. 1978; Cantor et al. 1978; Young et al. 1981). All of these studies were limited by a lack of attention to important details (e.g., migration, exposure to other carcinogens). Better designed and better conducted epidemiology studies of occupational exposure would be helpful. The information can be useful to populations living near hazardous waste sites where chloroform is present. In addition, further refining of the PBPK/PD models would further advance our understanding of chloroform tissue dosimetry in humans and animals.

### **Biomarkers of Exposure and Effect.**

**Exposure.** Methods for detecting chloroform in exhaled breath, blood, urine, and tissues are available. Nevertheless, it is difficult to correlate chloroform levels in biological samples with exposure, because of the volatility and short half-life of chloroform in biological tissues. Several studies monitored chloroform levels in environmentally exposed populations (Antoine et al. 1986; Hajimiragha et al. 1986; Peoples et al. 1979); however, the measured levels probably reflect both inhalation and oral exposure. Moreover, increased tissue levels of chloroform or its metabolites may reflect exposure to other chlorinated hydrocarbons. Studies to better quantitate chloroform exposure would enhance the database.

**Effect.** No biomarkers were identified that are particularly useful in characterizing the effects induced by exposure to chloroform. The target organs of chloroform toxicity are the central nervous system, the liver, and kidneys; however, damage to these organs may result from exposure to other chemicals.

## 2. HEALTH EFFECTS

More effort to identify subtle biochemical changes to serve as biomarkers of effects of chloroform exposure would be useful in detecting early, subtle signs of chloroform-induced damage.

**Absorption, Distribution, Metabolism, and Excretion.** Human data indicate that chloroform absorption from the lungs is rapid and fairly complete (Smith et al. 1973). The data also indicate that absorption after oral exposure is fairly complete for both animals and humans (Brown et al. 1974a; Fry et al. 1972; Taylor et al. 1974). Although there are no experimental data regarding dermal absorption in humans, some data have been extrapolated from mouse studies (Tsuruta 1975). The rate of absorption following oral or inhalation exposure is rapid (within 1-2 hours). Additional animal studies investigating the rate of dermal absorption would be useful to quantitate dermal absorption and to compare information from oral and inhalation studies.

Data are available regarding the distribution of chloroform in animals after inhalation and oral exposure to chloroform (Brown et al. 1974a; Chenoweth et al. 1962; Cohen and Hood 1969; Corley et al. 1990; Danielsson et al. 1986; Taylor et al. 1974); however, data regarding the distribution of chloroform in humans is very limited (Feingold and Holaday 1977) and warrants further investigation. It appears that distribution following oral exposure is similar to that following inhalation exposure. Another well conducted animal study focusing on distribution and excretion after dermal exposure would be useful to assess exposure via this route.

The metabolic pathways of chloroform metabolites are well understood. It appears that both the mode of oral administration and the vehicle affect metabolism. Additional data investigating the mode and vehicle of administration would be useful in order to understand the role of these factors in the mechanism of chloroform's toxicity. The co-administration of other compounds (e.g., ethanol) has been shown to alter chloroform metabolism and toxicity. Further investigations of the hazards associated with exposure to complex mixtures containing chloroform would be useful.

The excretion of chloroform and its metabolites is understood, based on human and animal data derived from oral and inhalation studies (Brown et al. 1974a; Corley et al. 1990; Fry et al. 1972; Taylor et al. 1974). The major route of chloroform elimination is pulmonary, but minor pathways are through enterohepatic circulation, urine, and feces as parent compound or metabolites. There are no human or animal data regarding excretion of dermally applied chloroform.



## 2. HEALTH EFFECTS

**Comparative Toxicokinetics.** Target organs for chloroform distribution appear to be similar in humans and animals, according to inhalation studies (Corley et al. 1990; Feingold and Holaday 1977). Nonetheless, human and animal studies indicate that there are large interspecies differences in chloroform metabolism and tissue partition coefficients (Brown et al. 1974a; Corley et al. 1990). Marked sex-related differences in tissue distribution and covalent binding to tissue MMBs in mice also have been observed (Taylor et al. 1974). Excretion data indicate that humans and nonhuman primates excrete chloroform in the breath primarily as unchanged chloroform; mice eliminated almost 80% of an oral chloroform dose as CO<sub>2</sub>, (Brown et al. 1974a). Thus, toxicokinetic data indicate that it may be difficult to compare the toxicokinetics of chloroform in animals with that in humans. There are a large number of oral studies, relatively few inhalation studies, and almost no dermal studies regarding the toxicokinetics of chloroform. Quantitative toxicokinetic studies in several animal species involving exposure to chloroform via all three routes, especially inhalation and dermal, would help complete the database.

**Methods for Reducing Toxic Effects.** Protective clothing and protective breathing devices may be used to prevent exposure to large amounts of chloroform, although for everyday low exposures to chloroform, these methods are obviously impractical. General procedures such as flushing the skin with water following dermal exposure and emesis or gastric lavage following oral exposure may be used to reduce absorption of chloroform. However, specific medical treatments that prevent absorption of chloroform have not been identified. Such mechanisms might be beneficial because they might be more effective than general procedures and might involve less risk than procedures such as emesis. Ways to enhance elimination of chloroform from the body are not known. Although chloroform is eliminated fairly rapidly, methods to accelerate elimination without producing toxic metabolites would be helpful in reducing toxicity. The mechanism by which chloroform produces toxicity appears to involve metabolism by phenobarbital-inducible isozymes of cytochrome P-450 to phosgene (Pohl et al. 1980a, 1980b). Development of methods to selectively inhibit the P-450 isozymes responsible for this reaction might reduce chloroform toxicity. There is also evidence that GSH conjugates with reactive products of chloroform metabolism, providing protection from damaging effects (Docks and Krishna 1976; Hook and Smith 1985). Development of a method to maintain high tissue GSH levels following exposure to chloroform might have a mitigating effect on toxicity. Therefore, although no treatments are currently available to block the toxic action of chloroform or repair damage caused by this chemical, there are indications that further research in this area would enable identification of such treatments.

## 2. HEALTH EFFECTS

### 2.10.3 Ongoing Studies

A few ongoing studies involving chloroform have been identified. The effects of volatile anesthetics on the N-methyl-D-aspartate (NMDA) receptor-channel complex are being studied. Specific aims are to determine the effects of several volatile anesthetics (halothane, enflurane, isoflurane, diethyl ether, cyclopropane, nitrous oxide, and chloroform) on ligand binding to glutamate binding sites on the NMDA receptor complex; to study ligand binding to the glycine modulatory site, glutamate, glycine, divalent cation, and spermidine activation of NMDA receptor ion channels; and to examine NMDA receptor mediated changes in calcium content of rat brain microvesicles (Aronstam 1994). Mechanistic work on the hepatotoxicity and toxigenic sequence will be studied *in vitro* with suspensions of hepatocytes exposed to carbon tetrachloride and other agents known to alter calcium homeostasis and stimulate phospholipase A<sub>2</sub> (bromotrichloromethane and chloroform) (Glende 1994). Mechanisms of toxic chemical interactions in the liver resulting in hepatotoxicity will utilize the hepatotoxic effects of chloroform to explore interactions among metals and organics in the induction of stress response proteins such as metallothionein, heme oxygenase, and nitric oxide synthase, and the induction of inflammatory cytokines (i.e., tumor necrosis factor- $\alpha$ , interleukin-1, and interleukin-6). Work by Swenburg will determine if exposure to environmental carcinogens, including 1,1,2-trichloroethylene, 1,1,2,2-tetrachloroethylene, 1,1,2-trichloroethane, chloroform, and carbon tetrachloride, induces or modulates the formation and/or repair of cyclic DNA adducts. Work by Benjamin (1995) will also continue to study the phenomenon of hepatic cell proliferation, and the effect that this response has on the initiation and promotion of cancer. Other research will investigate the toxicity and bioaccumulation of a mixture of sediment contaminants (trichloroethylene, lead, benzene, chloroform, phenol, chromium, and arsenic) in several species of invertebrates and fish. Uptake and depuration will be measured in chironomids (*Chironomus riparius*), and pharmacokinetic models will be developed to describe bioaccumulation of these sediment contaminants (Clements 1994). Studies by Yang (1994) will continue to evaluate age- and dosing-related changes in pharmacokinetics, biochemical markers, liver cell proliferation, and histopathology in male Fischer 344 rats chronically exposed (up to 2 years) to low levels of a chemical mixture of 7 organic and inorganic groundwater pollutants (including arsenic, benzene, chloroform, chromium, lead, phenol, trichloroethylene). Also, this research will further explore the pharmacokinetic modeling of chemical mixtures and incorporate time-course information on biochemical markers, cell proliferation and histopathology into pharmacokinetic and pharmacodynamic modeling. A study by the Japan Industrial Safety and Health Association (Japan Bioassay Lab) that explores the toxicity of chloroform inhaled over a 2-year period

## 2. HEALTH EFFECTS

(6 hours a day, 5 days a week) in male and female Fischer 344 rats and BDF<sub>1</sub> mice is reportedly close to completion (Matsushima 1994). Efforts are also being made to develop a high-efficiency activated carbon granule for drinking-water treatment that can remove water contaminants, including chloroform (Mieville 1992).

### **3. CHEMICAL AND PHYSICAL INFORMATION**

#### **3.1 CHEMICAL IDENTITY**

Information regarding the chemical identity of chloroform is located in Table 3-1.

#### **3.2 PHYSICAL AND CHEMICAL PROPERTIES**

Information regarding the physical and chemical properties of chloroform is located in Table 3-2.

## 3. CHEMICAL AND PHYSICAL INFORMATION

**Table 3-1. Chemical Identity of Chloroform**

Characteristic	Information	Reference
Chemical name	Trichloromethane	SANSS 1990
Synonym(s)	Methenyl chloride, methane trichloride, methyl trichloride, formyl trichloride	IARC 1979
Registered trade name(s)	Freon 20, R 20, R 20 refrigerant	IARC 1979
Chemical formula	CHCl <sub>3</sub>	Weast 1988
Chemical structure	$  \begin{array}{c}  \text{Cl} \\    \\  \text{H} - \text{C} - \text{Cl} \\    \\  \text{Cl}  \end{array}  $	IARC 1979
Identification numbers:		
CAS registry	67-66-3	Weast 1988
NIOSH RTECS	FS 9100000	HSDB 1996
EPA hazardous waste	UO44	HSDB 1996
OHM/TADS	7216639	HSDB 1996
DOT/UN/NA/IMCO shipping	Chloroform; UN 1888; IMO 6.1	HSDB 1996
HSDB	56	HSDB 1996
NCI	CO2686	HSDB 1996

CAS = Chemical Abstracts Services; DOT/UN/NA/IMCO = Department of Transportation/United Nations/North America/International Maritime Dangerous Goods Code; EPA = Environmental Protection Agency; HSDB = Hazardous Substances Data Bank; NCI = National Cancer Institute; NIOSH = National Institute for Occupational Safety and Health; OHM/TADS = Oil and Hazardous Materials/Technical Assistance Data System; RTECS = Registry of Toxic Effects of Chemical Substances

## 3. CHEMICAL AND PHYSICAL INFORMATION

**Table 3-2. Physical and Chemical Properties of Chloroform**

Property	Information	Reference
Molecular weight	119.38	Deshon 1979
Color	Colorless	Hawley 1981
Physical state	Liquid	Deshon 1979
Melting point	-63.2 °C -64 °C -63.5 °C	Deshon 1979 Verschuieren 1983 Weast 1988
Boiling point	61.3 °C 62 °C 61.7 °C	Deshon 1979 Verschuieren 1983 Weast 1988
Density: at 20 °C	1.485 g/cm <sup>3</sup> 1.4832 g/cm <sup>3</sup>	Hawley 1981 Weast 1988
Odor	Pleasant, ethereal, nonirritating Pleasant, sweet	Deshon 1979 NFPA 1994
Odor threshold:		
Water	2.4 ppm (w/v)	Amoore and Hautala 1983
Air	85 ppm (v/v)	Amoore and Hautala 1983
Solubility: Water at 25 °C	7.22x10 <sup>3</sup> mg/L 9.3x10 <sup>3</sup> mg/L 7.43 x 10 <sup>3</sup> mg/L	Banerjee et al. 1980 Verschuieren 1983 Merck 1989
Organic solvent(s)	Miscible with principal organic solvents Miscible with alcohol, benzene, ether, petroleum ether, carbon tetrachloride, carbon disulfide, oils	Deshon 1979 Merck 1989
Partition coefficients:		
Log K <sub>ow</sub>	1.97	Hansch and Leo 1985, Verschuieren 1983
Log K <sub>oc</sub>	1.65 2.40	Sabljić 1984 Aster 1996
Vapor pressure at 20 °C	159 mm Hg 160 mm Hg 160 mm Hg	Boublik et al. 1984 Verschuieren 1983 NFPA 1994
Henry's law constant:		
at 20 °C	3.0x10 <sup>-3</sup> atm-m <sup>3</sup> /mol	Nicholson et al. 1984
at 24.8 °C	3.67x10 <sup>-3</sup> atm-m <sup>3</sup> /mol	Gossett 1987
at 25 °C	4.06x10 <sup>-3</sup> atm-m <sup>3</sup> /mol	SRC 1994a

## 3. CHEMICAL AND PHYSICAL INFORMATION

**Table 3-2. Physical and Chemical Properties of Chloroform (continued)**

Property	Information	Reference
Decomposition rates	Negligible rate of hydrolysis Half-life of 80 days in air with photochemically produced hydroxyl radicals	Mabey and Mill 1978 Hampson 1980
	Residence time in air 116 days	Singh et al. 1981
Hydrolysis rate constant at 25 °C for pH>8	$6.44 \times 10^{-5}$ L/mol-sec	SRC 1994b
Autoignition temperature	>1,000 °C	Deshon 1979
Flashpoint	None	Deshon 1979
Flammability limits	No data	No data
Conversion factors in air (20 °C)	1 ppm (v/v)=4.96 mg/m <sup>3</sup>	Calculated
	1 mg/m <sup>3</sup> =0.20 ppm (v/v)	Calculated
Other	Reacts with strong alkalies and aluminum	NFPA 1994
	<i>Oxidized by strong oxidizing agents such as chromic acid, with formation of phosgene and chlorine gas</i>	HSDB 1996
Explosive limits	No data	No data

v/v = volume per volume; w/v = weight per volume

#### 4. PRODUCTION, IMPORT/EXPORT, USE, AND DISPOSAL

Chloroform is used primarily in the production of chlorodifluoromethane (hydrochlorofluorocarbon-22 or HCFC-22) used as a refrigerant for home air conditioners or large supermarket freezers and in the production of fluoropolymers (CMR 1995). Chloroform has also been used as a solvent, a heat transfer medium in fire extinguishers, an intermediate in the preparation of dyes and pesticides, and other applications highlighted below. Its use as an anesthetic has been largely discontinued. It has limited medical uses in some dental procedures and in the administration of drugs for the treatment of some diseases.

##### 4.1 PRODUCTION

The chlorination of methane and the chlorination of methyl chloride produced by the reaction of methanol and hydrogen chloride are the two common methods for commercial chloroform production (Ahlstrom and Steele 1979; Deshon 1979). The Vulcan Materials Co., Wichita, Kansas, was documented as still using the methanol production process during the late 1980s with all other facilities in the United States at that time using the methyl chloride chlorination process (SRI 1990).

One U.S. manufacturer began chloroform production in 1903, but significant commercial production was not reported until 1922 (IARC 1979). Since the early 1980s, chloroform production increased by 20-25%, due primarily to a higher demand for HCFC-22, the major chemical produced from chloroform. The Montreal Protocol established goals for phasing out the use of a variety of ozone-depleting chemicals, including most chlorofluorocarbons (CFCs). HCFC-22 was one of the few fluorocarbons not restricted by the international agreement. Chloroform is used in the manufacture of HCFC-22, and an increase in the production of this refrigerant has led to a modest increase in the demand for chloroform (CMR 1989). These increasing trends in U.S. production, based on information compiled in the trade journal *Chemical & Engineering News* for period from 1983 through 1994 (CEN 1995), are summarized in Table 4-1.

The manufacturers and sites of major chloroform production facilities identified for 1993 (SRI 1993) include the following: Dow Chemical U.S.A., Freeport, Texas, and Plaquemine, Louisiana; Occidental Petroleum Corp., Belle, West Virginia; and Vulcan Materials Co., Geismar, Louisiana, and Wichita, Kansas. Estimated annual production capacity (SRI 1993) from these facilities as of January 1, 1993,



## 4. PRODUCTION, IMPORT/EXPORT, USE, AND DISPOSAL

**Table 4-1. U.S. Production of Chloroform**

Year	U.S. production (in millions of pounds)	U.S. production (in millions of kg)
1983	362	164
1984	405	183
1985	275	124
1986	422	191
1987	462	209
1988	524	237
1989	588	266
1990	484	219
1991	505	229
1992	na	na
1993	476	215
1994	565	254

Taken from Chemical & Engineering News 1995

## 4. PRODUCTION, IMPORT/EXPORT, USE, AND DISPOSAL

was 460 million pounds (208 million kg). By early 1995, the Occidental Petroleum Corporation facility in West Virginia had ceased its chloroform production operations (CMR 1995; SRI 1995). While precise production figures for the 4 remaining sizable U.S.-based facilities are not available, the annual production capacity estimate for the Dow plant in Freeport, Texas, was 135 million pounds (61.8 million kg); capacity for the Dow plant at Plaquemine, Louisiana, was 150 million pounds (67.5 million kg); capacity at the Vulcan plant at Geismar, Louisiana, was 90 million pounds (40.5 million kg); and capacity at the Vulcan plant at Wichita, Kansas, was 145 million pounds (62.3 million kg); for a total United States annual production capacity of around 520 million pounds (234 million kg) from these 4 large plants (CMR 1995). An estimate of actual production (CEN 1995) in the United States during 1994 was 565 million pounds (254 million kg).

Table 4-2 lists the facilities in each state that manufacture or process chloroform, the intended use, and the range of maximum amounts of chloroform that are stored on site. The data listed in Table 4-2 are derived from the Toxics Release Inventory (TRI93 1995). Only plants from 3 states (associated with the 4 plants noted above) actually generate chloroform as an end-product for sale or distribution. In most cases, chloroform is a chemical intermediary, impurity, or waste by-product at the 172 facilities included in the TRI survey. Only certain types of facilities were required to report; therefore, this is not an exhaustive list. In some cases, facility names are not available or numeric values for amounts of chloroform produced, stored, transferred, or released are missing. This complicates making comparisons between the TRI listings and information from other information sources.

## 4.2 IMPORT/EXPORT

In 1985, the United States imported 27.6 million pounds (12.5 million kg) of chloroform; 24 million pounds (10.8 million kg) of chloroform were imported into the United States in 1988 (CMR 1989; HSDB 1996). More recent U.S. import figures from the National Trade Data Bank (NTDB 1995) are:

U.S. Imports for Year	Quantity (kg)
1990	10,624,006
1991	9,460,747
1992	6,038,483
1993	8,467,294
1994	2,398,668

## 4. PRODUCTION, IMPORT/EXPORT, USE, AND DISPOSAL

**Table 4-2. Facilities That Manufacture or Process Chloroform**

State <sup>a</sup>	Number of facilities	Range of maximum amounts on site in thousands of pounds <sup>b</sup>	Activities and uses <sup>c</sup>
AK	2	0-1	1, 5, 6
AL	12	0-1000	1, 5, 6, 7, 12
AR	6	0-1000	1, 5, 6, 7, 13
AZ	1	0-1	1, 5
CA	2	0-0	1, 6, 13
CO	1	10-100	2, 6, 11
CT	1	100-1000	11
FL	7	0-100	1, 5, 6, 13
GA	6	0-10	1, 5, 6
ID	1	1-10	1, 5
IL	2	10-1000	11
IN	3	1-100	11, 13
KS	2	100-10000	1, 3, 4, 7, 13
KY	7	0-10000	1, 3, 5, 6, 7, 10, 13
LA	16	0-50000	1, 2, 3, 4, 5, 6, 7, 11, 13
MA	1	10-100	12
MD	1	0-1	1, 5
ME	7	0-1	1, 5, 6
MI	5	0-10000	1, 5, 6, 7, 11, 12, 13
MN	3	0-100	1, 5, 8, 12
MO	2	10-100	8, 10, 11
MS	2	0-1	1, 6
MT	1	0-1	1, 5
NC	4	0-1000	1, 5, 6, 11
NH	1	0-1	1, 5
NJ	4	0-1000	1, 5, 7, 8, 11
NY	3	0-100	1, 5, 6, 11, 13
OH	3	0-100	1, 6, 10, 11
OK	1	0-0	1, 5
OR	3	0-10	1, 6, 11
PA	7	0-1000	1, 5, 6, 11
PR	6	0-1000	11, 12, 13
SC	5	0-10	1, 5, 6, 8, 10
TN	2	0-1	1, 5, 6
TX	17	0-50000	1, 2, 4, 5, 6, 7, 9, 12, 13
VA	4	0-1000	1, 5, 11
VT	1	10-100	8
WA	7	0-10	1, 5, 6

## 4. PRODUCTION, IMPORT/EXPORT, USE, AND DISPOSAL

**Table 4-2. Facilities That Manufacture or Process Chloroform (continued)**

State <sup>a</sup>	Number of facilities	Range of maximum amounts on site in thousands of pounds <sup>b</sup>	Activities and uses <sup>c</sup>
WI	11	0-100	1, 5, 6, 7, 11, 13
WV	3	10-10000	1, 4, 5, 9, 11, 13

Source: TRI93 1995

<sup>a</sup> Post office state abbreviations used<sup>b</sup> Data in TRI are maximum amounts on site at each facility<sup>c</sup> Activities/Uses:

- |                               |                                  |
|-------------------------------|----------------------------------|
| 1. Produce                    | 8. As a formulation component    |
| 2. Import                     | 9. As a product component        |
| 3. For on-site use/processing | 10. For repackaging only         |
| 4. For sale/distribution      | 11. As a chemical processing aid |
| 5. As a by-product            | 12. As a manufacturing aid       |
| 6. As an impurity             | 13. Ancillary or other uses      |
| 7. As a reactant              |                                  |

## 4. PRODUCTION, IMPORT/EXPORT, USE, AND DISPOSAL

These import statistics suggest a slight decrease in chloroform imports from the late 1980s into the 1990s. Additional data would be needed to evaluate properly the drastic decrease in imports for 1994.

In 1985, 33.5 million pounds (15.2 million kg) of chloroform were exported (HSDB 1994); for 1988, exports of 40 million pounds (18.1 million kg) were estimated (CMR 1989). More recent export figures from the National Trade Data Bank (NTDB 1995) are:

U.S. Exports for Year	Quantity (kg)
1989	26,756,412
1990	21,897,011
1991	23,709,482
1992	20,133,535
1993	31,620,815
1994	42,320,259

These statistics suggest an overall increase in export levels from the mid-1980s through the mid-1990s.

### 4.3 USE

The major use for chloroform (CMR 1989) is in the manufacture of the refrigerant HCFC-22. Chloroform has been used in the past as a solvent or an extraction solvent for fats, oils, greases, resins, lacquers, rubber, alkaloids, gums, waxes, gutta-percha, penicillin, vitamins, flavors, floor polishes, and adhesives in artificial silk manufacture. It is also used as a dry cleaning spot remover, in fire extinguishers, as an intermediate in the manufacture of dyes and pesticides, and as a fumigant (Deshon 1979). Chloroform was previously used as an anesthetic, but it has been replaced by safer and more versatile materials (Deshon 1979). The U.S. Food and Drug Administration (FDA) banned chloroform use in drug, cosmetic, and food packaging products in 1976 (see Chapter 7). This ruling did not include drug products that contain chloroform in residual amounts resulting from its use as a processing solvent in manufacturing or its presence as a by-product from the synthesis of drug ingredients (IARC 1979). Chloroform can still apparently be used as a local anesthetic and solvent in certain dental endodontic (gutta-percha root canal) surgery procedures (McDonald and Vire 1992).

#### 4. PRODUCTION, IMPORT/EXPORT, USE, AND DISPOSAL

Topically applied aspirin-chloroform mixtures are also used to relieve pain from severe cases of herpes zoster (shingles) or posttherapeutic neuralgia (King 1993).

A recent summary of major domestic uses for chloroform noted the following percentage breakdowns typical of the early to mid-1990s (CMR 1995): use for manufacture of HCFC-22, 98% (refrigerants, 70%; fluoropolymers, 30%); other miscellaneous uses, including laboratory reagents and 'extraction solvents for pharmaceuticals, 2%.

As discussed in Chapter 5, the most common chloroform exposure opportunities for members of the general population are related less to any commercially produced form of the chemical than to chloroform generated when organic materials come in contact with chlorinated oxidants (e.g., chlorine or hypochlorous acid) widely used to purify water or remove pathogens from waste materials.

#### 4.4 DISPOSAL

According to the 1993 TRI, the amount of chloroform released to land is only a small fraction (less than 1%) of the total amount of chloroform released to the environment by facilities that produce and process the chemical (see Section 5.2.3) (TR193 1995). TRI also documents 2,386,285 pounds (1,073,828 kg) transferred to off-site waste handling sites in 1993, a level amounting to around 17% the total releases to environmental media and larger than any releases to environmental media other than air (TR193 1995). The TRI data should be used with caution since only certain types of facilities are required to report. This is not an exhaustive list.

Chloroform has been identified as a hazardous waste by EPA, and disposal of this waste is regulated under the Federal Resource Conservation and Recovery Act (RCRA) (EPA 1988a, 1989b). Specific information regarding federal regulations on chloroform disposal on land is available in the Code of Federal Regulations (EPA 1988a, 1989b). Ultimate disposal of chloroform, preferably mixed with another combustible fuel, can be accomplished by controlled incineration. Complete combustion must be ensured to prevent phosgene formation, and an acid scrubber should be used to remove the haloacids produced. Chloroform also is a potential candidate for liquid injection incineration. Because chloroform has been used in some pesticides, the disposal of containers for these pesticides may be relevant. Combustible containers from organic or many metallo-organic pesticides could be disposed of in pesticide incinerators or in specified landfill sites. Noncombustible containers could be disposed

#### 4. PRODUCTION, IMPORT/EXPORT, USE, AND DISPOSAL

of in a designated landfill or recycled (HSDB 1996). Except for the TRI statistics, no data were located regarding the approximate amounts of chloroform disposed or released to environmental media. Chapter 7 provides more details on federal or state regulations governing the disposal of chloroform.

## 5. POTENTIAL FOR HUMAN EXPOSURE

### 5.1 OVERVIEW

Chloroform is both a synthetic and naturally occurring compound, although anthropogenic sources are responsible for most of the chloroform in the environment. Chloroform is released into the environment as a result of its manufacture and use; its formation in the chlorination of drinking water, municipal and industrial waste water, and swimming pool and spa water; and from other water treatment processes involving chlorination. Under anaerobic conditions, some bacteria can dehalogenate carbon tetrachloride to release chloroform. Most of the chloroform released into the environment will eventually enter the atmosphere. In the atmosphere, chloroform may be transported long distances before ultimately being degraded by indirect photochemical reactions with such free radicals as hydroxyl. The compound has been detected in ambient air in locations that are remote from anthropogenic sources. Chemical hydrolysis is not a significant removal process. While microbial biodegradation can take place, such reactions are generally possible only at fairly low concentration levels due to chloroform's toxicity. Microbial biodegradation of chloroform may also be inhibited due to high levels of other aromatics (e.g., toluene), chlorinated hydrocarbons (e.g., trichloroethylene [TCE]), or heavy metals (e.g., zinc). Because of its low soil adsorption and slight, but significant, water solubility, chloroform will readily leach from soil into groundwater. In groundwater, chloroform is expected to persist for a long time.

The general population is exposed to chloroform by ingesting water and food, inhaling contaminated air, and possibly through dermal contact with chloroform-containing water. Generalizations can be made concerning the chloroform concentrations in the environment. Background air concentrations appear to be in the sub-ppb range, but certain urban, indoor, and source-dominated areas may show elevated concentrations when compared to background concentrations. Drinking water levels as high as 311 ppb have been reported in public water supplies, although most of the reported concentrations are less than 50 ppb, typically ranging between 2 and 44 ppb. Levels in drinking water derived from groundwater contaminated with leachate from landfills and hazardous waste sites can sometimes be much higher. Except for a few special surveys, regular testing for chloroform or other trihalomethanes (THMs) has focused on larger community water treatment systems serving at least 10,000 people. Very limited information was located regarding the concentrations found in ambient soil. Chloroform has also been detected in the ppb range in certain foods.



## 5. POTENTIAL FOR HUMAN EXPOSURE

Occupational exposure to higher than background levels of chloroform can be expected to occur in some occupations although few quantitative exposure data were located. Populations with the highest potential exposures appear to be workers employed in or persons living near industries and facilities that manufacture or use chloroform; operators and individuals who live near municipal and industrial waste water treatment plants and incinerators, and paper and pulp plants; and persons who derive their drinking water from groundwater sources contaminated with leachate from hazardous waste sites.

Chloroform has been identified in at least 717 of 1,428 current or past EPA National Priorities List (NPL) sites (HazDat 1996). However, the number of sites evaluated for chloroform is not known. Figure 5-1 shows the distribution of sites in the continental United States; there are 710 such sites. In addition, there are 6 sites in the Commonwealth of Puerto Rico and one site in the Virgin Islands (not shown in Figure 5-1).

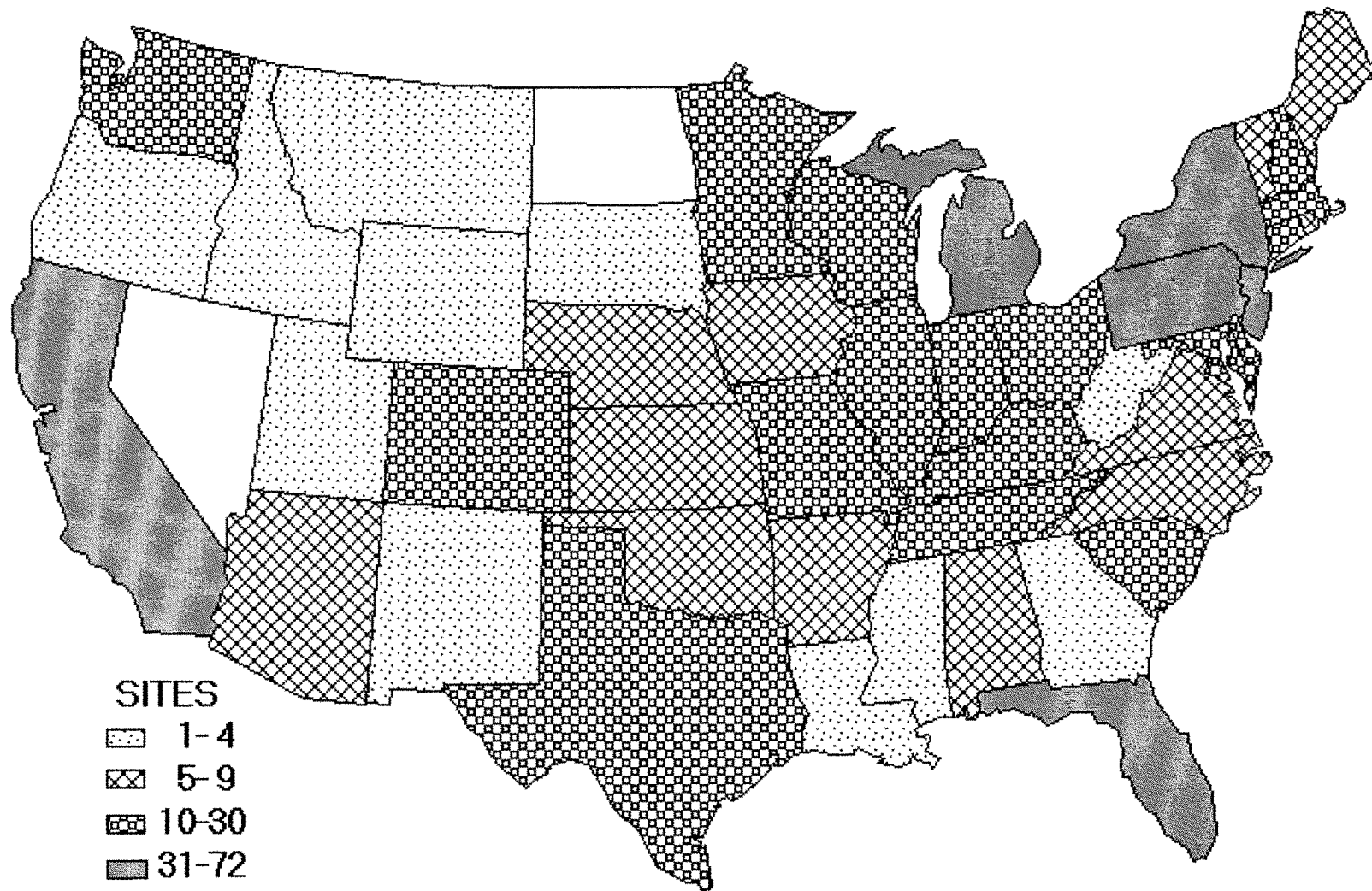
### 5.2 RELEASES TO THE ENVIRONMENT

#### 5.2.1 Air

According to the 1991 Toxic Chemical Release Inventory (TR191 1993), releases of chloroform to the air from 182 large processing facilities were 17,034,926 pounds (8,413,971 kg). This represented about 95% of the total releases to environmental media. For TRI information from 1993 (TR193 1995), 13,485,992 pounds (6,068,696.4 kg) were reported as released to the air from 172 facilities, which represents around 97.1% of the total releases to environmental media. Since there was a slight decrease in overall chloroform production in 1993 as compared with 1991 (CEN 1995), it is difficult to attribute this decrease in releases to the air to improved pollution prevention measures as opposed to short-term fluctuations related to production capacity utilization factors. The releases of chloroform to air from facilities that manufactured and processed it in the United States during 1993 are reported in Table 5-1 (TR193 1995). The TRI data should be used with caution because only certain types of facilities are required to report. This is not an exhaustive list.

Current comprehensive quantitative data or estimates of chloroform releases to the atmosphere are lacking. Some direct releases to the atmosphere are expected to occur during the manufacture, loading, and transport of chloroform (EPA 1985a, 1985b). Indirect chloroform releases have resulted from its use in the manufacture of hydrochlorofluorocarbon-22, fluoropolymers, pharmaceuticals,

Figure 5-1. Frequency of NPL Sites with Chloroform Contamination



**SITES**  
1-4  
5-9  
10-30  
31-72

Derived from HazDat 1996

Table 5-1. Releases to the Environment from Facilities That Manufacture or Process Chloroform

State <sup>b</sup>	Number of facilities	Range of reported amounts released in pounds per year <sup>a</sup>						
		Air	Water	Land	Underground injection	Total environment <sup>c</sup>	POTW transfer	Off-site waste transfer
AK	2	140697-240000	19000-40869	0	0	181566-259000	0	0
AL	12	250-620000	0-16000	0-2000	0	250-636000	0	0-132346
AR	6	1-229000	0-3600	0-5	0	1-229960	0	0-250
AZ	1	23000	0	22400	0	45400	0	0
CA	2	0-3150	0-3600	0	0	0-6750	0	0
CO	1	500	0	0	0	500	250	67000
CT	1	2250	14400	0	0	16650	0	242520
FL	7	62-235000	0-11100	0-3700	0	62-239120	0-53580	0-18500
GA	6	21199-329000	0-4500	0-750	0	21949-333273	0	0-130
ID	1	88000	750	5	0	88755	0	0
IL	2	108-2150	0	0	0	108-2150	0-500	12242-160130
IN	3	250-9700	0-30	0	0	250-9730	0	5-99000
KS	2	40000-44662	0	0	0-37950	40000-82612	0	781-7726
KY	7	0-150000	0-7200	0-5	0	0-157205	0-849	0-89630
LA	16	3-280000	0-16600	0-250	0-15	34-284950	0	0-72280
MA	1	17650	0	0	0	17650	0	975
MD	1	17000	0	0	0	17000	32000	0
ME	7	28933-441000	650-2200	0-130	0	30377-441756	0	0-370
MI	5	2475-55000	2-570	0-79	0	2500-55600	0-15000	0-596
MN	3	8400-140000	0-4000	0-7	0	12407-140000	0-18417	0-1600
MO	2	8750-105000	0	0	0	8750-105000	250-3400	32100-114500
MS	2	25510-292000	1269-15000	1-5	0	26780-307005	0	0
MT	1	49800	700	0	0	50500	0	0
NC	4	98000-730000	0-3200	0	0	98000-730650	0-5	0-730
NH	1	36953	79	18	0	37050	0	0
NJ	4	150-18200	0-439	0	0	150-18639	0-13350	0-44300
NY	3	10-11000	0-250	0	0	10-11250	0-12	250-28729
OH	3	406-22100	0-820	0	0	406-22920	0	0-4037

**Table 5-1. Releases to the Environment from Facilities That Manufacture or Process Chloroform (continued)**

State <sup>b</sup>	Number of facilities	Range of reported amounts released in pounds per year <sup>a</sup>						
		Air	Water	Land	Underground injection	Total environment <sup>c</sup>	POTW transfer	Off-site waste transfer
OK	1	93200	700	550	0	94450	0	0
OR	3	1000-143800	0-3000	0	0	1000-146800	0-100000	250-16000
PA	7	10700-231000	0-2900	0-15	0	10700-232705	0-70000	0-55700
PR	6	0-92072	0	0	0	0-92072	0-161519	0-306374
SC	5	500-136540	0-5649	0	0	500-138440	0-5	0-500
TN	2	38000-47763	1900-7441	0-160	0	39900-55364	0	0-3
TX	17	5-600000	0-5350	0-900	0-74	5-600000	0-112000	0-377935
VA	4	55950-187000	31-2600	0-170	0	57979-187063	0	0
VT	1	4	0	0	0	4	0	168700
WA	7	5036-196000	0-15000	0-5	0	12275-200500	0	0
WI	11	1000-150000	0-4900	0-250	0	1000-152500	0-13	0-51000
WV	3	870-22276	0-654	0-200	0	870-23130	0-1	0-1328

Source: TRI93 1995

<sup>a</sup> Data in TRI are maximum amounts released by each facility.

<sup>b</sup> Post office state abbreviations used

<sup>c</sup> The sum of all releases of the chemical to air, land, water, and underground injection wells by a given facility

POTW = publicly owned treatment works

## 5. POTENTIAL FOR HUMAN EXPOSURE

ethylene dichloride, dyes, and fumigants (Deshon 1979; EPA 1985a, 1985b; HSDB 1996).

Chloroform releases result from its formation and subsequent volatilization from chlorinated waters including drinking water, municipal and industrial waste waters, process waters and effluent from the bleaching of pulp in pulp and paper mills, cooling-tower water, and swimming-pool and whirlpool-spa water (Benoit and Jackson 1987; EPA 1985a, 1985b; Hoigne and Bader 1988). Increased release rates of the chloroform in waters can be expected from chloroform-containing waters that are heated (e.g., water used for cooking, showers, swimming pools, and spas). Aeration and use of groundwater contaminated with chloroform are a potential source of emission to the atmosphere (Crume et al. 1990). Chloroform is released as a result of hazardous and municipal waste treatment processes. The chloroform released may have initially been present in the waste or possibly formed during chlorination treatment (Corsi et al. 1987; EPA 1990b; Namkung and Rittmann 1987). Releases may also occur from hazardous waste sites and sanitary landfills where chloroform was disposed, and from municipal and hazardous waste incinerators that burn chloroform-containing wastes or produce chloroform during the combustion process (LaRegina et al. 1986; Travis et al. 1986).

In the past, minor releases may have resulted from the use of consumer products (e.g., certain air deodorizers and cleaning products) that contained chloroform as a component or residual product (Bayer et al. 1988; Wallace et al. 1987a). Chloroform is widely used in laboratory work as an extractant. It is also still used in certain medical procedures, such as dental root canal surgeries (McDonald and Vire 1992), and in combination with aspirin as an experimental treatment for serious cases of herpes zoster (King 1993). These medical uses are extremely limited and would contribute very minor amounts of chloroform as releases to the air.

### 5.2.2 Water

In 1991, releases of chloroform to the water from as many as 167 large processing facilities were 654,452 pounds (323,250 kg) (TR191 1993), amounting to about 3.6% of total releases to all environmental media. TRI information from 1993 (TR193 1995) indicates releases of chloroform to water from as many as 165 facilities were 335,032 pounds (150,764.4 kg) (TR193 1995), or about 2.4% of the total releases to all environmental media. The releases of chloroform to water from facilities that manufactured and processed it in the United States during 1993 are reported in Table 5-1 (TR193 1995). The TRI data indicate that only a small fraction of the chloroform released to the

## 5. POTENTIAL FOR HUMAN EXPOSURE

environment is released to water. The TRI data should be used with caution because only certain types of facilities are required to report. This is not an exhaustive list.

Current, more comprehensive quantitative data or estimates of chloroform releases to natural waters are lacking. Direct releases to water are expected via waste waters generated during chloroform manufacture and its use in the manufacture of other chemicals and materials (EPA 1985a). Direct discharge sources are expected to be relatively minor contributors to total chloroform emissions to water relative to the formation of chloroform resulting from the chlorination of drinking water or chlorination to eliminate pathogens in discharged wastes or other process waters (EPA 1985a). Since chlorination to disinfect water supplies is nearly universal, chloroform contamination resulting from chlorination will also be widespread (see discussion on levels monitored or estimated in water in Section 5.4.2).

Other chloroform emission sources tend to be relatively isolated point sources. Chlorination of municipal and industrial waste waters at municipal and industrial waste water-treatment plants, process waters and effluent from the bleaching of pulp in pulp and paper mills, cooling-tower water, and swimming-pool and whirlpool-spa water will also result in chloroform formation (Benoit and Jackson 1987; Comba et al. 1994; EPA 1985a, 1985b, 1990a; Hoigne and Bader 1988). The use of modern treatment facilities may reduce the amounts of chloroform released to environmental waters. This has been demonstrated at a modern kraft pulp mill (Paasivirta et al. 1988); however, much of the chloroform removed from the waste water may be released to the atmosphere by volatilization. Release of chloroform to groundwater has resulted from improper disposal of chloroform-containing waste at hazardous waste sites (Clark et al. 1982; Dewalle and Chian 1981; Harris et al. 1984; Sawhney 1989). An additional minor source of water contamination may be atmospheric rainout since chloroform has been found in rainwater (Kawamura and Kaplan 1983). Other sources of chloroform release to surface water include breweries, thermal combustion of plastics, reaction of dissolved chlorine with sediment and other materials in water, biological production by marine algae, and the reaction of chlorinated pollutants with humic materials in natural waters (EPA 1985a).

### 5.2.3 Soil

In 1991, releases of chloroform to the land from as many as 137 large processing facilities were 28,582 pounds (14,117 kg), which amounts to less than 1% of the total releases to all environmental

## 5. POTENTIAL FOR HUMAN EXPOSURE

media (TR191 1993). TRI information from 1993 (TR193 1995) indicates releases to the land from as many as 124 facilities was 32,926 pounds (14,816.7 kg), which is less than 1% of the total releases to all environmental media. The releases of chloroform to soil from facilities that manufactured and processed it in the United States during 1993 are reported in Table 5-1 (TR193 1995). The TRI data indicate that only a very small fraction of the chloroform released to the environment is released to land. The TRI data should be used with caution since only certain types of facilities are required to report. This is not an exhaustive list.

Current comprehensive quantitative data or estimates of chloroform releases to soil are lacking. Chloroform releases to soil have occurred at hazardous waste sites containing improperly disposed wastes where chloroform has leached through soil to groundwater (Clark et al. 1982; Dewalle and Chian 1981; Harris et al. 1984; Sawhney 1989). Land disposal of sludge from municipal and industrial waste water-treatment plants may also result in chloroform releases to soil (EPA 1990a). Direct land disposal of chloroform-containing wastes may have occurred in the past, but land disposal of chloroform wastes is currently subject to restrictive regulations (EPA 1988a, 1989b). An additional minor source of soil contamination may be atmospheric rainout since chloroform has been found in rainwater (Kawamura and Kaplan 1983).

Chloroform has been used as a carrier or solvent for some pesticides (HSDB 1996). It is still used as a carrier for at least one pesticide formulation with dichlorvos as the active ingredient (Petrelli et al. 1993). Application of pesticides using chloroform in the carriers could have resulted in releases of chloroform to the land. It is impossible to quantify the magnitude of such releases, and the chloroform could be expected to be transported to either the atmosphere through volatilization or, if dissolved in water, carried into surface waters or groundwater.

### 5.3 ENVIRONMENTAL FATE

#### 5.3.1 Transport and Partitioning

Based upon a vapor pressure of 159 mm Hg at 20 °C, chloroform is expected to exist almost entirely in the vapor phase in the atmosphere (Boublik et al. 1984; Eisenreich et al. 1981). Large amounts of chloroform in the atmosphere may be removed by wet deposition since chloroform has significant solubility in water. This is confirmed by its detection in rainwater (Kawamura and Kaplan 1983).

## 5. POTENTIAL FOR HUMAN EXPOSURE

Most of the chloroform removed in precipitation, however, is likely to reenter the atmosphere by volatilization. Trace amounts of chloroform have been documented in air samples from remote, often relatively pristine, areas of the world (Class and Ballschmidter 1986). Since chloroform is relatively nonreactive in the atmosphere, long-range transport within the atmosphere is possible. The detections in remote areas may also mean that the chloroform is produced as the result of more localized transformation processes, possibly including the reaction of naturally generated chlorinated oxidants with organic matter.

The dominant fate process for chloroform in surface waters is volatilization. Chloroform present in surface water is expected to volatilize rapidly to the atmosphere. An experimental half-disappearance range of 18-25 minutes has been measured for volatilization of chloroform from a 1 ppm solution with a depth of 6.5 cm that was stirred with a shallow pitch propeller at 200 rpm at 25 °C under still air ( $\approx 0.2$  mph air currents) (Dilling 1977; Dilling et al. 1975). Using the Henry's law constant, a half-life of 3.5 hours was calculated for volatilization from a model river 1 meter deep flowing at 1 meter/second, with a wind velocity of 3 m/second, and neglecting adsorption to sediment (Lyman et al. 1982). A half-life of 44 hours was estimated for volatilization from a model pond using EXAMS (1988).

Based on a measured soil organic carbon sorption coefficient ( $K_{oc}$ ) of 45 (or a log [ $K_{oc}$ ] of 1.65), chloroform is not expected to adsorb significantly to sediment or suspended organic matter in surface water (Sabljić 1984). This prediction is supported by sediment monitoring data that indicate that this compound has not been detected (or was detected at very low concentrations) in sediment samples (Bean et al. 1985; Ferrario et al. 1985; Helz and Hsu 1978). Little or no chloroform concentration was observed on peat moss, clay, dolomite limestone, or sand added to water (Dilling et al. 1975). Chloroform slightly adsorbed to aquifer solids in laboratory studies utilizing different amounts of two different aquifer materials with  $K_{oc}$  values ranging from 63.4 to 398. The authors reported higher adsorption with increasing organic content of the solids (Uchrin and Mangels 1986).  $K_{oc}$  values ranging from 45 to 80 in soil have been experimentally determined for chloroform (Sabljić 1984; Wilson et al. 1981).

Chloroform does not appear to bioconcentrate in higher aquatic organisms, based upon measured bioconcentration factors (BCF) of 6 and 8 for bluegill sunfish (*Lepomis macrochirus*) (Barrows et al. 1980; Veith et al. 1980). Information from EPA's ASTER (1996) database document a calculated



## 5. POTENTIAL FOR HUMAN EXPOSURE

BCF for the fathead minnow of 14, a low value suggesting little potential for bioconcentration in fish. A BCF of 690 experimentally determined for the bioconcentration of chloroform in the green algae *Selenastrum capricornutum* suggests that the compound has a moderate tendency to concentrate in nonvascular aquatic plants (Mailhot 1987). No data regarding the biomagnification potential of chloroform were found. Based upon the observed BCF, however, significant biomagnification of chloroform is apparently unlikely.

In soil, the dominant transport mechanism for chloroform near the surface will probably be volatilization because of its high volatility and low soil adsorption. Volatilization rates seem relatively constant over a wide variety of soil types (Park et al. 1988). In other laboratory studies, 75% of the chloroform initially present in water volatilized when applied to a fine sandy soil, and 54% of the chloroform volatilized from a soil column during a percolation study utilizing a sandy soil (Piwoni et al. 1986; Wilson et al. 1981). All or nearly all of the remaining chloroform traveled through the soil because of its low adsorption onto soil. Another laboratory study of 15 common volatile or semivolatile organic chemicals reported a disappearance half-life for chloroform of 4.1 days, which assumed first-order kinetic decay (Anderson et al. 1991). The leaching potential of chloroform is further confirmed by the detection of chloroform in groundwater, especially at hazardous waste sites (Clark et al. 1982; Dewalle and Chian 1981; Harris et al. 1984; Sawhney 1989).

### 5.3.2 Transformation and Degradation

For air, the major degradation process involves reactions with free radicals such as hydroxyl groups (Atkinson 1985). For other media, it is clear that chloroform can be mineralized through both abiotic and biotic processes. Information in the available literature (Bouer and McCarty 1983; Rhee and Speece 1992) documents the disappearance of chloroform in water and soil media under both aerobic and anaerobic conditions as well as identification of the end products.

#### 5.3.2.1 Air

The vapor-phase reaction of chloroform with photochemically generated hydroxyl radicals is the dominant degradation process in the atmosphere. The rate constant for this process at 25 °C has been experimentally determined as  $1.0 \times 10^{-13}$  cm<sup>3</sup>/molecule-second, which corresponds to a half-life of  $\approx 80$  days based upon a 12-hour sunlit day in a typical atmosphere containing  $1 \times 10^6$  hydroxyl

## 5. POTENTIAL FOR HUMAN EXPOSURE

radicals/cm<sup>3</sup> (Hampson 1980; Singh et al. 1981). Breakdown products from reaction with hydroxyl radicals probably include phosgene and hydrogen chloride (Atkinson 1985). Chloroform is more reactive in photochemical smog conditions where the approximate half-life is 11 days (Dimitriades and Joshi 1977). Direct photolysis of chloroform will not be a significant degradation process in the atmosphere. Chloroform solutions sealed in quartz tubes and exposed to sunlight for one year degraded at almost the same rate as solutions in sealed tubes stored in the dark, which indicated that very little or no photodegradation of the compound had occurred (Dilling et al. 1975). This is expected because chloroform does not show significant light absorbance at wavelengths >290 nm (Hubrich and Stuhl 1980).

### 5.3.2.2 Water

Hydrolysis will not be a significant degradation process in water based upon rate constants experimentally determined at 25 °C that correspond to half-lives ranging from 1,850 to 3,650 years at pH 7, and from 25 to 37 years at pH 9 (Jeffers et al. 1989; Mabey and Mill 1978). Direct photolysis of chloroform will not be a significant degradation process in surface waters because, as noted above, the compound does not absorb light at wavelengths >290 nm (Hubrich and Stuhl 1980). The reaction rate of chloroform with hydrated electrons photochemically produced from dissolved organic matter has been predicted to correspond to a near-surface half-life of ≈44 days based upon an experimentally determined rate constant and a hydrated electron concentration of  $1.2 \times 10^{-17}$  mol of hydrolyzed electrons/L (Zepp et al. 1987). This latter process is probably too slow to effectively compete with volatilization as a removal process from surface waters.

Biological degradation of chloroform has been studied primarily with an eye to batch process operation at waste water treatment plants or remediation possibilities at hazardous waste disposal sites. Above certain dosage levels, chloroform becomes toxic to anaerobic and aerobic microorganisms. This is especially noticeable for biological treatment facilities that use anaerobic digestion systems, where sustained inputs with chloroform concentrations approaching 100 mg/L can all but eliminate methanogenic (methane-fermenting) bacteria (Rhee and Speece 1992). Other studies have shown appreciable inhibition of methanogenesis with levels of chloroform in the range of 1 mg/L (Hickey et al. 1987). Other chlorinated hydrocarbons, and particularly such common 2-carbon chlorinated aliphatics as TCE, can similarly inhibit bacteria found in sewage sludges (Long et al. 1993; Rhee and Speece 1992). Similar inhibition effects can be the result of heavy metal toxics, zinc being

## 5. POTENTIAL FOR HUMAN EXPOSURE

particularly stressful to methanogenic bacteria (van Beelen et al. 1994; van Vlaardingen and van Beelen 1992). Studies of actual natural waters or waste waters, where it is difficult to control the levels of specific chemicals or preclude inputs of other toxicants, yield a wide variety of results on the efficiencies of chloroform biodegradation. For instance, little or no degradation was observed during 25 weeks in aqueous aerobic screening tests utilizing primary sewage effluent inocula (Bouwer et al. 1981a). No chloroform degradation was observed in aerobic biofilm column studies (Bouwer et al. 1981b). Significant degradation of chloroform (46-49% loss in 7 days, at least some of which was apparently due to volatilization) in aerobic screening tests utilizing settled domestic waste water as inoculum was reported (Tabak et al. 1981). Under the proper conditions, chloroform appears to be much more susceptible to anaerobic biodegradation. Degradation of chloroform under anaerobic conditions was more rapid at lower chloroform concentrations (81 and 99% degradation after 2 and 16 weeks, respectively, at 16 ppb); a more gradual degradation was observed at higher concentrations and 78% degradation after 2 and 16 weeks, respectively, at 157 ppb (Bouwer et al. 1981a). No degradation was observed, however, when chloroform was incubated with aquifer material under anaerobic conditions for 27 weeks (Wilson et al. 1981).

In the absence of toxicity from other solvents, chlorinated hydrocarbons, or heavy metals, and where chloroform concentrations can be held below approximately 100 ppb, both aerobic and anaerobic bacteria can biodegrade chloroform, with removal rates well over 80% in a period of 10 days (Long et al. 1993). Deviations from these ideal conditions can lead to lower removal efficiencies. These biodegradation reactions generally lead to the mineralization of the chloroform to chlorides and carbon dioxide (Bouwer and McCarty 1983; Rhee and Speece 1992). One study, however, documents the production of the toxicant methylene chloride (dichloromethane) from the breakdown of chloroform-containing wastes in a mixed culture of bacteria from sewage sludge (Rhee and Speece 1992 citing results from work at Tyndall AFB, Florida). Caution should be exercised in making generalizations without site-specific evidence, however, since commercial grades of chloroform will often contain methylene chloride as an impurity (HSDB 1996). In waters containing mixtures of different chlorinated aliphatics, biodegradation may produce new chloroform, at least as a temporary by-product, the breakdown of carbon tetrachloride into chloroform having been confirmed in laboratory studies (ATSDR 1994; Long et al. 1993; Picardal et al. 1993).

## 5. POTENTIAL FOR HUMAN EXPOSURE

### 5.3.2.3 Sediment and Soil

Little information was located regarding the degradation of chloroform in soil. Based upon data for degradation in water, chemical degradation in soil is not expected to be significant. The available soil data suggest that chloroform biodegradation rates in soil may vary, depending upon conditions. In soil column studies, the chloroform present in the influent secondary waste water appeared to pass through the column nearly unchanged even though some of the other organic compounds present were apparently biodegraded, which indicated that the waste water was not too toxic to the microorganisms in the soil (Bouwer et al. 1981b). In contrast to these studies, significant degradation of chloroform (33% removed in 6 days) was observed in fine sandy soil in sealed bottles; however, the chloroform may have been co-metabolized by methylotropic bacteria already present in the soil. The aerobic degradation was even faster in methane-enriched soil (Henson et al. 1988). Such bio-oxidation of chloroform was also observed under methanogenic conditions in batch experiments using an inoculum derived from activated sludge and in a continuous-flow laboratory scale column, using a methanogenic fixed film derived from primary sewage effluent (Bouwer and McCarty 1983). Overall, biodegradation in soil is not expected to compete with the predicted rapid rate of volatilization from soil (Park et al. 1988). As with biodegradation in water, concentrations of chloroform above certain threshold levels may inhibit many bacteria, especially methane-fermenting bacteria under anaerobic or near-anaerobic conditions (Hickey et al. 1987).

## 5.4 LEVELS MONITORED OR ESTIMATED IN THE ENVIRONMENT

### 5.4.1 Air

Data from the most recent study located (1982-85 air samples) reported that the background level of chloroform concentrations over the northern Atlantic ocean ranges from  $2 \times 10^{-5}$  to  $5 \times 10^{-5}$  ppm (Class and Ballschmidter 1986). This range does not differ significantly from the range reported for 1976-79 ( $1.4-4 \times 10^{-5}$  ppm) and the range reported from the 1987 update of the National Ambient Volatile Organic Compounds Database (NAVOCDB), which was  $2 \times 10^{-5}$  ppm (Brodzinsky and Singh 1982; EPA 1988b; Singh 1977; Singh et al. 1979). The maximum and background levels found in 7 U.S. cities between 1980 and 1981 were  $5.1 \times 10^{-3}$  and  $2 \times 10^{-5}$  ppm, respectively (Singh et al. 1982). Average atmospheric levels in U.S. cities ranged from  $2 \times 10^{-5}$  to  $2 \times 10^{-3}$  ppm between 1980 and 1981. The median concentration reported between 1977 and 1980 was  $7.2 \times 10^{-5}$  ppm, and the median

## 5. POTENTIAL FOR HUMAN EXPOSURE

reported in the 1987 update of the NAVOCDB was  $6 \times 10^{-5}$  ppm (Brodzinsky and Singh 1982; EPA 1988b; Singh et al. 1981, 1982; Wallace et al. 1986a, 1986b, 1988). A recent update to EPA's volatile organic compounds (VOC) databases on background ambient air concentrations for hazardous air pollutants (Kelly et al. 1994) estimated a chloroform background ambient level for chloroform in the United States as  $4 \times 10^{-5}$  ppm.

The median concentration for source-dominated areas in the United States is  $8.2 \times 10^{-4}$  ppm for data reported between 1977 and 1980, and this figure does not differ significantly from the  $5.1 \times 10^{-4}$  ppm values reported in the 1987 update of the NAVOCDB (Brodzinsky and Singh 1982; EPA 1988b). Certain source-dominated areas contained much higher chloroform levels. The ambient air concentrations outside homes in Love Canal, New York, in 1978, ranged from  $2 \times 10^{-4}$  to  $2.2 \times 10^{-2}$  ppm, and the maximum concentration found in ambient air at 20 California municipal landfills was 0.61 ppm (Barkley et al. 1980; Wood and Porter 1987). Concentrations ranging from  $2.9 \times 10^{-4}$  to  $6 \times 10^{-3}$  ppm were found in air samples taken from 5 hazardous waste sites in New Jersey (LaRegina et al. 1986). Ambient air samples measured near a hazardous waste landfill contained  $\leq 1 \times 10^{-3}$  ppm chloroform. All these data indicate that chloroform levels in air can be much higher in areas near hazardous waste sites (Stephens et al. 1986). Other source-dominated areas that may have ambient air chloroform concentrations significantly higher than background levels include areas near facilities that treat hazardous and municipal waste, as well as areas near contaminated groundwater, and municipal- and hazardous-waste incinerators (Corsi et al. 1987; EPA 1990a; LaRegina et al. 1986; Namkung and Rittmann 1987; Travis et al. 1986).

Typical median indoor air concentrations of chloroform range from  $\approx 2 \times 10^{-4}$  to  $4 \times 10^{-3}$  ppm (Barkley et al. 1980; Pellizzari et al. 1986; Wallace et al. 1987c, 1989). Chloroform concentration ratios of indoor air to outdoor air range from  $<1$  to 25 (Pellizzari et al. 1986). One of the most significant indoor sources of chloroform is chlorinated tap water, and taking showers (and breathing air where chloroform has been released from the shower water) is expected to contribute a substantial amount to the indoor chloroform levels (Andelman 1985a, 1985b; Wallace 1987). A recent study investigating typical levels of various VOCs in the air in Canadian homes noted median chloroform concentrations of  $4 \times 10^{-4}$  ppm (Otson et al. 1994).

The air around swimming pools may also contain chloroform. This is especially likely in heated, indoor pools, which can approximate the conditions found in shower stalls. Concentrations ranging

## 5. POTENTIAL FOR HUMAN EXPOSURE

from  $3.5 \times 10^{-2}$  to  $19.9 \times 10^{-2}$  ppm (440-2,335 nmol/m<sup>3</sup>) have been reported for environmental air at an indoor swimming pool (Aggazzotti et al. 1990, 1993).

Chloroform has been identified in at least 717 of 1,428 current or past NPL sites (HazDat 1996).

Chloroform has been detected in air samples taken at an estimated 57 of the 717 NPL hazardous waste sites where chloroform was detected.

### 5.4.2 Water

Recent monitoring data regarding the presence of chloroform in surface water, sediments, and groundwater were not located. The most recent monitoring data that were obtained involved chloroform levels in drinking water. Finished drinking water collected in 1988 from 3.5 sites across the United States contained median concentrations of chloroform ranging from 9.6 to 15 µg/L (Krasner et al. 1989). In an analysis of available monitoring data from raw water supplies, the maximum detected value was 136 ppb (EPA/AMWA 1989). Data from earlier studies indicate a wide range of concentrations have been found in drinking-water supplies. The reported chloroform concentrations that were detected ranged from trace levels to 311 ppb, with one study reporting a median concentration of 16.7 ppb and another study reporting a geometric mean concentration of 1.81 ppb. Most of the concentrations ranged between 22 and 68 ppb (Brass et al. 1977; EPA/AMWA 1989; Furlong and D'Itri 1986; Kasso and Wells 1981; Krasner et al. 1989; Rogers et al. 1987; Symons et al. 1975). Chloroform can be expected to exist in virtually all chlorinated drinking-water supplies. The main source of chloroform found in municipal drinking water is the chlorination of naturally occurring humic materials found in raw-water supplies (Bellar et al. 1974; Cech et al. 1982). Factors that can increase the amount of chloroform in drinking water include seasonal effects (high summer values) and increased contact time between chlorine and humic material. Sources of water with high humic material content will contain higher levels of chloroform. The chloroform concentration increases with time, indicating that concentrations of the compound increase as the water moves through the distribution system (Kasso and Wells 1981). Drinking water derived from groundwater, especially groundwater at or near some hazardous waste sites and landfills, may contain higher levels of chloroform than normally encountered in drinking water derived from surface water. Chloroform levels ranging from 2.1 to 1,890 ppb have been observed in drinking water derived from wells near a hazardous waste dump (Clark et al. 1982). The leachate from one solid waste landfill contained 21,800 ppb chloroform; drinking water obtained from wells in the vicinity of the landfill had

## 5. POTENTIAL FOR HUMAN EXPOSURE

chloroform levels of 0.3-1.6 ppb (Dewalle and Chian 1981). Data from the most recent study of Kansas groundwater sampled in 1986 indicate concentrations ranging from  $\approx 0.3$  to 91 ppb in both raw and treated groundwater; the average and median concentrations in the treated water were 7.6 and 0.5 ppb, respectively (Miller et al. 1990). Of the sample sites in a national groundwater supply survey, 45% had detectable levels of chloroform, and median and maximum concentrations were 1.5 and 300 ppb, respectively (Westrick et al. 1989).

In addition to drinking water, chlorinated oxidants reacting with organic materials will lead to the formation of chloroform in swimming pools. Since swimming pools are not routinely analyzed for their chloroform content, data are limited and derived from special studies. Such studies will often cover the broader family of THMs, and while chloroform levels in blood or alveolar air samples will be reported, the environmental agents will often simply be recorded in terms of THMs. A rule of thumb (Copaken 1990) is that up to 90% of the THMs in chlorinated water samples will be chloroform. Recorded concentrations in samples from public pools fall in a range of 25-137 ppb (Aiking et al. 1994; Barnes et al. 1989; Copaken 1990). In poorly tended or very crowded public or private pools, where there are large inputs of organic materials or heavy use of chlorinating agents, chloroform levels as high as 163 ppb have been documented (Barnes et al. 1989). Chloroform production in swimming pools can be increased where the pools are treated with copper-containing algicides. In tests on chlorinated water using various doses of chlorine, copper (cupric valence form) from different copper-containing salts, and varying levels of humic acid (Barnes et al. 1989), chloroform concentrations after a given reaction time were generally 50% or more higher in samples treated with copper, which acts as a catalyst in the reactions with the humic acids.

Current reviews of surface water monitoring data in the peer reviewed literature are lacking. The highest concentrations observed in surface waters of the United States sampled before 1984 were 394 and 120 ppb. These concentrations were observed in rivers in highly industrialized cities (Ewing et al. 1977; Pellizzari et al. 1979). Typical concentrations for most sites that are not heavily industrialized appear to range from trace levels to  $\approx 22$  ppb (Ohio River Valley Sanitation Commission 1980, 1982). Data from EPA's STORET database indicate that chloroform was detected in 64% of 11,928 surface water sample data points at a median concentration of 0.30 ppb (Staples et al. 1985).

Chloroform at 0.25 ppb has been found in rainwater collected in Los Angeles, California, during 1982 (Kawamura and Kaplan 1983).

## 5. POTENTIAL FOR HUMAN EXPOSURE

Chloroform has been detected in surface-water samples taken at an estimated 139 of 717 current or past NPL sites where chloroform was detected (HazDat 1996). Detections in groundwater are documented at 552 sites. From the available information found in HazDat (1996), groundwater appears to be the most common environmental medium at NPL sites where chloroform might be encountered.

### 5.4.3 Sediment and Soil

Chloroform has been found in sediment samples. Chloroform was found in sediment samples taken in 1980 from the 3 passes of Lake Pontchartrain, Louisiana, at concentrations ranging from 1.7 to 18 ng/kg (w/w [weight per weight] basis) (Ferrario et al. 1985). Chloroform was found at concentrations ranging from 30 to 80 ng/kg (dry weight basis) in sediment samples exposed to chlorinated electrical power plant cooling water; the control samples that were not exposed to cooling water contained nearly the same amounts of chloroform (Bean et al. 1985). Data from EPA's STORET database indicate that chloroform was detected in 8% of 425 sediment sample data points at a median concentration of <5.0 µg/kg (Staples et al. 1985).

Routine sediment sampling for chloroform does not seem common in the United States, and sampling at relatively unpolluted ambient monitoring sites may overlook the levels possible in more restricted hotspots. Anaerobic biodegradation of chlorinated hydrocarbons may generate chloroform, especially in harbors, shipping canals, or areas receiving large amounts of industrial discharges. Where the sediments contain large concentrations of zinc, which is widely used to galvanize metal or as an ingredient in common industrial rust inhibitors, methanogenic bacteria populations may be adversely affected, thus preventing the mineralization of chloroform. Chloroform in interstitial water may then build up to levels as high as 50 ppb (van Beelen et al. 1994; van Vlaardingen and van Beelen 1992).

Soil monitoring data in the peer reviewed literature could not be located. It can be predicted that chloroform contamination occurs at hazardous waste sites where chloroform-containing leachate moves through the soil to groundwater. An explanation of the lack of data results from the fact that any chloroform in the soil is expected to either rapidly volatilize or leach. Laboratory studies using a variety of different soil types document the effectiveness of volatilization in removing chloroform from soils (Park et al. 1988).



## 5. POTENTIAL FOR HUMAN EXPOSURE

Chloroform has been found in soil samples taken at an estimated 213 of the 717 current or past NPL where chloroform was detected (HazDat 1996). Detections in sediment samples are documented for 79 current or past NPL sites. Detections on soil gas obtained from soil samples were documented at 18 sites.

### 5.4.4 Other Environmental Media

Chloroform has been detected in various foods at the following concentrations: soft drinks and beverages (2.7-178  $\mu\text{g}/\text{kg}$ ), dairy products (7-1,110  $\mu\text{g}/\text{kg}$ ), oils and fats (traces <12  $\mu\text{g}/\text{kg}$ ), dried legumes (6.1-57.2  $\mu\text{g}/\text{kg}$ ), and grains and milled grain products (1.4-3,000  $\mu\text{g}/\text{kg}$ ) (Abdel-Rahman 1982; Entz et al. 1982; Graham and Robertson 1988; Heikes 1987; Heikes and Hopper 1986; Lovegren et al. 1979). In a study of various foods, 41% of 231 samples contained chloroform at levels ranging from 4 to 312  $\mu\text{g}/\text{kg}$ ; the average level was 52  $\mu\text{g}/\text{kg}$  (Daft 1988a). In another broad study, 55% of 549 samples contained between 2 and 830  $\mu\text{g}/\text{kg}$ . The average level in this study was 71  $\mu\text{g}/\text{kg}$  (Daft 1989). The chloroform concentration observed in other foods ranged from 6.1 to 1,110  $\mu\text{g}/\text{kg}$ . The highest amounts were found in butter (1,110  $\mu\text{g}/\text{kg}$ ), mixed cereal (220 $\mu\text{g}/\text{kg}$ ), infant/junior food (230  $\mu\text{g}/\text{kg}$ ), and cheddar cheese (83  $\mu\text{g}/\text{kg}$ ) (Heikes 1987).

Chloroform has been detected in the air above outdoor and indoor pools and in spas at maximum concentrations of  $2.8 \times 10^{-2}$ ,  $5.0 \times 10^{-2}$ , and  $5.2 \times 10^{-2}$  ppm, respectively; water concentrations ranged between 4 and 402, 3 and 580, and <0.1 and 530 ppb, respectively (Armstrong and Golden 1986). In another study, air samples above whirlpool spas treated with chlorine disinfectant contained chloroform at concentrations ranging from  $8 \times 10^{-4}$  to  $1.5 \times 10^{-1}$  ppm; the concentration in the water ranged from 15 to 674 ppb (Benoit and Jackson 1987). Chloroform has been detected at  $\leq 37$  ppb in the cooling water of a nuclear reactor; a concentration of 50 ppb was detected 0.75 miles downstream from the reactor cooling tower in one study (Hollod and Wilde 1982).

Since chloroform is highly volatile and shows little tendency to bioconcentrate or bioaccumulate in higher life forms such as fishes, it is not ordinarily included in the types of persistent pollutants that are the focus of state fish consumption advisory programs. Information from HazDat (1996) does document detections of chloroform in tissues from fishes from at least 3 current or past NPL sites.

## 5. POTENTIAL FOR HUMAN EXPOSURE

### 5.5 GENERAL POPULATION AND OCCUPATIONAL EXPOSURE

The general population is probably exposed to chloroform through drinking water and beverages, eating food, inhaling contaminated air, and through dermal contact with water (e.g., while showering, bathing, cleaning, washing, swimming). All humans are expected to be exposed to at least low levels of chloroform. Accurate, current estimates of the daily intake of chloroform by various exposure routes are not available, or possible, due to the lack of appropriate current monitoring data. Typical levels of atmospheric exposure in remote, urban, and source-dominated areas range from  $2 \times 10^{-5}$  to  $5 \times 10^{-5}$ ,  $6 \times 10^{-5}$  to  $2 \times 10^{-3}$ , and  $8.2 \times 10^{-4}$  to  $2.2 \times 10^{-2}$  ppm, respectively (Barkley et al. 1980; Brodzinsky and Singh 1982; Class and Ballschmidter 1986; EPA 1988a; Singh et al. 1981, 1982; Wallace et al. 1986a, 1986b, 1988; Wood and Porter 1987). Exposure via ingestion of contaminated drinking water is expected to be extensive since most U.S. community drinking-water supplies are chlorinated (see Singer 1994 for an overview of the entire topic of disinfection by-products in drinking water). Typical levels in drinking water range from 2 to 68 ppb (Brass et al. 1977; EPA/AMWA 1989; Furlong and D'Itri 1986; Kasso and Wells 1981; Krasner et al. 1989; Rogers et al. 1987; Symons et al. 1975). Although data regarding levels in food are rather scant, typical average chloroform levels in certain foods are estimated to range from 52 to 71  $\mu\text{g}/\text{kg}$  (Daft 1988a, 1988b, 1989).

Although data are available from various studies regarding concentrations of chloroform found in human tissues, blood, and expired air, only limited data are available that compare these concentrations to measured or estimated environmental exposure levels. Furthermore, no correlation has been made between these measured human tissue concentrations and the corresponding environmental exposure levels (see Section 2.5.1 for a discussion of the relationship between chloroform exposure levels and concentrations found in humans). Much of the data available is from the Total Exposure Assessment Methodology (TEAM) studies (see Andelman 1990 or Wallace 1995 for succinct overviews) in which the concentration of chloroform was measured in personal air samples and exhaled human breath (Wallace 1987; Wallace et al. 1984, 1986a, 1986b, 1988). For example, in one TEAM study, the ratios of the concentrations of chloroform detected in personal air samples to those found in human exhaled breath air varied from 0.66:1 to 13.3:1 (Wallace 1987) (see Section 2.5.1 for more data regarding concentrations found in humans, including data obtained during autopsies). Recent studies supported through IARC on swimmers using indoor pools in Europe showed good correlations between the chloroform concentrations in alveolar air and blood plasma concentrations (Aggazzotti et al. 1990, 1993). Plasma levels ranging from 0.8 to 25.1 nmol/L were observed. Statistical analysis

## 5. POTENTIAL FOR HUMAN EXPOSURE

showed the plasma levels to be significantly correlated with concentrations of chloroform in the pool water, time spent swimming, the number of swimmers in the pool, and the chloroform concentration in the environmental air.

Limited current data were located regarding occupational exposure to chloroform. Although some of the exposure levels encountered in workplaces may be comparable to exposure the worker receives in his own home, there are probably many specific jobs that expose the workers to significantly higher levels of chloroform. These occupations include work at or near source-dominated areas such as chemical plants and other facilities that manufacture or use chloroform, operation of chlorination processes in drinking-water plants, work at or near waste water-treatment plants and paper and pulp plants, and other facilities where large amounts of chloroform are released (e.g., hazardous and municipal-waste incinerators). Persons working at waste water and other treatment plants can be exposed to significant levels of chloroform. A maximum level of  $3.8 \times 10^{-3}$  ppm was found in the air at an activated sludge waste-water treatment plant (Lurker et al. 1983). Maintenance workers, attendants, and life guards at indoor pools and spas may encounter maximum concentrations of  $5.0 \times 10^{-2}$  and  $1.5 \times 10^{-1}$  ppm, respectively (Armstrong and Golden 1986; Benoit and Jackson 1987). Persons who use tap water often, especially if it is heated and/or sprayed (e.g., water used for cleaning, washing clothes and dishes, showering, and cooking), may be exposed to higher than background levels. For example, levels in personal air samples as high as  $2.2 \times 10^{-2}$  and  $1.1 \times 10^{-2}$  ppm have been measured during household cleaning activities and showering (Wallace et al. 1987d). While the use of activated carbon filters may provide some reduction in the tap water levels for cold water feeds, such filters are not effective with hot water where the elevated temperatures will induce volatilization from the filter media. Persons using certain cleaning agents and pesticides in enclosed spaces with poor ventilation or persons working where these materials are used may be exposed to relatively high levels of chloroform.

A National Occupational Exposure Survey (NOES) conducted by NIOSH from 1981 to 1983 estimated that 95,778 workers in the United States are potentially exposed to chloroform (NOES 1991). In the absence of more recent national occupational exposure data, the NOES information still has some value. The NOES database does not contain information on the frequency, concentration, or exposure duration of workers; it only provides estimates of the number of workers potentially exposed to chemicals in the workplace. Of the 151 different occupational groups with potential chloroform exposure risks listed in the NOES database, approximately 50% of the potentially exposed workers fall

## 5. POTENTIAL FOR HUMAN EXPOSURE

into the following Standard Industrial Classification (SIC) categories: Funeral Service and Crematory Technicians from SIC category 7261; Biological, Engineering or Chemical Technicians and Chemists from the Research and Development Laboratory SIC category 7391; Adhesive and Sealant Chemical Technicians from SIC category 2891; Assemblers from SIC category 3679 (Electronic Components) and SIC Category 3622 (Industrial Controls); Petroleum Refining Machine Operators and other Workers from SIC category 2911; and General Medical and Surgical Hospital Clinical Laboratory Technologists and Technicians from SIC category 8062.

### 5.6 POPULATIONS WITH POTENTIALLY HIGH EXPOSURES

All humans are exposed to low concentrations of chloroform. Those with potentially high exposures are workers employed in chloroform manufacturing and use industries. Persons living in certain source-dominated areas may be at risk for higher than background exposures to chloroform. These may include persons living near industries and facilities that manufacture and use chloroform, municipal and industrial waste water-treatment plants and incinerators, paper and pulp plants, and persons who derive their drinking water from groundwater sources contaminated with chloroform-containing leachate from hazardous waste sites.

Previously reported air monitoring data from landfills and other waste sites (see Section 5.4.1) suggest that potentially high exposure may occur via inhalation of contaminated air near hazardous waste sites. Other possibilities include drinking water from wells contaminated with chloroform that leached from the sites and, perhaps, living in homes built directly on top of former waste sites. Although some of the drinking-water supplies contaminated solely by leached chloroform (e.g., levels  $\leq 1.6$  ppb from a water well near a site with documented chloroform contamination) (Dewalle and Chian 1981) have shown levels lower or comparable to that in normal chlorinated drinking water, where chloroform levels in the range of 2-44 ppb are common (EPA/AMWA 1989), much higher levels (1,890 ppb) have been found in water from wells near a waste dump (Clark et al. 1982). HazDat (1996) documents 239 current or past NPL sites where specific concentration levels for groundwater are contained in the database. At least 97 current or past NPL sites show groundwater samples where values are 100 ppb or higher. A drinking-water standard of 100 ppb for total trihalomethanes (TTHMs) (where chloroform is usually the predominant constituent) is EPA's current requirement for treated water systems serving 10,000 or more consumers (see Chapter 7 below).

## 5. POTENTIAL FOR HUMAN EXPOSURE

### 5.7 ADEQUACY OF THE DATABASE

Section 104(i)(5) of CERCLA, as amended, directs the Administrator of ATSDR (in consultation with the Administrator of EPA and agencies and programs of the Public Health Service) to assess whether adequate information on the health effects of chloroform is available. Where adequate information is not available, ATSDR, in conjunction with the NTP, is required to assure the initiation of a program of research designed to determine the health effects (and techniques for developing methods to determine such health effects) of chloroform.

The following categories of possible data needs have been identified by a joint team of scientists from ATSDR, NTP, and EPA. They are defined as substance-specific informational needs that if met would reduce the uncertainties of human health assessment. This definition should not be interpreted to mean that all data needs discussed in this section must be filled. In the future, the identified data needs will be evaluated and prioritized, and a substance-specific research agenda will be proposed.

#### 5.7.1 Identification of Data Needs

**Physical and Chemical Properties.** As reported in Table 3-2, the physical and chemical properties of chloroform have been characterized sufficiently to permit estimation of its environmental fate.

**Production, Import/Export, Use, Release, and Disposal.** Data regarding the production methods and current, past, projected future production capacity volumes, and current import and export volumes are available (Ahlstrom and Steele 1979; CEN 1995; Deshon 1979; NTDB 1994; SRI 1993, 1994; TR192 1994). However, these statistics will generally not include all instances where chloroform is generated as a chemical intermediate or waste product. With the exception of the partial coverage provided in the Toxics Release Inventory (TR191 1993; TR193 1995) comprehensive information regarding current release and disposal patterns, are lacking. General disposal information is adequately detailed in the literature, and information regarding disposal regulations of chloroform is available (EPA 1988a, 1988b). Production, release, and disposal data are useful to determine where environmental exposure to chloroform may be high. A major data need is to achieve a better understanding of why a substantial number of NPL sites show chloroform levels in groundwater at or above concentrations of 100 ppb. There are 239 sites in HazDat (1996) where groundwater

## 5. POTENTIAL FOR HUMAN EXPOSURE

concentration levels are documented. At least 36 sites show signs of groundwater contamination with levels of 1,000 ppb (or 1 ppm) or higher, levels high enough to suggest disposal or spills of wastes containing very high concentrations of chloroform. Sixty-one (61) sites show groundwater levels in a range from 100 to 1,000 ppb, and the remaining 142 sites show levels below 100 ppb. While some sites show very low levels comparable to the concentrations associated with many chlorinated public drinking-water supplies, the substantial number of sites with values at or slightly above the community drinking-water standard for TTHMs of 100 ppb deserves some scrutiny. Is the chloroform at such sites the result of past disposal of chloroform-laden wastes, or are some other sources (e.g., *in situ* generation of chloroform as the result of chemical or biochemical transformation of other on-site wastes) for the chloroform contamination involved? Present data sources are lacking to explain adequately the large number of NPL sites showing elevated levels of chloroform in such media as groundwater that pose major off-site exposure risks.

**Environmental Fate.** Experimental data are available regarding the transport and partitioning properties of chloroform in surface waters (Bean et al. 1985; Clark et al. 1982; Class and Ballschmidter 1986; Dilling 1977; Ferrario et al. 1985; Piwoni et al. 1986; Sawhney 1989). Chloroform partitions mainly into the atmosphere and into groundwater. Empirical measurements or model predictions on half-disappearance times in such media as soil could not be identified in the literature. Chloroform can be transported long distances in air. Data are available regarding the degradation of chloroform in the atmosphere, but less is known about degradation rates in water and soil (Anderson et al. 1991; Bouwer et al. 1981a, 1981b; Dilling et al. 1975; Hampson 1980; Henson et al. 1988; Jeffers et al. 1989; Park et al. 1988; Singh et al. 1981; Tabak et al. 1981; Wilson et al. 1981). Hydrolysis and direct photodegradation are not significant removal processes. Although data regarding biodegradation rates in natural media are lacking, volatilization is expected to dominate over biodegradation as a removal process from surface water and near-surface soil. Chloroform seems relatively persistent in the atmosphere and groundwater. The environmental fate of chloroform releases related to most common anthropogenic sources appears to be sufficiently determined by the available data. In light of the documented occurrence (Class and Ballschmidter 1986) of chloroform in remote, often pristine, areas, however, further study is warranted to help quantify the relative role of long-range transport processes as opposed to a variety of more localized potential chemical transformation processes. These more localized processes could include the reaction of naturally generated chlorinated oxidants with organic materials to yield chloroform. More data would be useful on the half-lives of chloroform in such media as soils.

## 5. POTENTIAL FOR HUMAN EXPOSURE

**Bioavailability from Environmental Media.** Chloroform is absorbed following inhalation, oral, and dermal contact. Toxicity studies of exposure to chloroform in air, water, and food demonstrated the bioavailability of chloroform by these routes. Data regarding its bioavailability from soil are lacking, but near-surface soil concentrations can be expected to be low due to volatilization (Piwoni et al. 1986; Wilson et al. 1981).

**Food Chain Bioaccumulation.** Data are available that indicate that chloroform does not bioconcentrate in aquatic organisms (Barrows et al. 1980; Veith et al. 1980); however, data are lacking for plants and other animals (e.g., vacuolar plants, shellfish, or macroinvertebrates) as well as for the biomagnification potential of chloroform in terrestrial and aquatic food chains. Additional information on bioconcentration and biomagnification could be useful in establishing the significance of food chain bioaccumulation as a route of human exposure.

**Exposure Levels in Environmental Media.** All humans are exposed to at least low levels of chloroform via inhalation of contaminated air, and most humans are exposed by drinking contaminated water. Estimates from intake via inhalation and ingestion of drinking water, based on limited data, are available (see Section 5.5). Exposure from foods cannot be estimated, due to the lack of data. Current information on exposure to chloroform from water, air, and foods, especially for workers or people who live near manufacturing and use facilities, water and waste water-treatment plants, municipal and industrial incinerators, hazardous waste sites, and other sources of significant release, in addition to data regarding exposure levels in indoor air would be useful.

**Exposure Levels in Humans.** Data regarding exposure levels in humans are incomplete and are usually the result of limited, special studies. Chloroform has been found in human blood and expired air of both occupationally and nonoccupationally exposed groups, and in breast milk of nonoccupationally exposed groups (Hajimiragha et al. 1986; Pellizzati et al. 1982; Wallace et al. 1987a). A detailed recent database of exposure would be helpful in determining the current exposure levels, thus allowing an estimation of the average daily dose associated with various scenarios, such as living near a point source of release, drinking contaminated water, or working in a contaminated place. This information is necessary for assessing the need to conduct health studies on these populations.

**Exposure Registries.** No exposure registries for chloroform were located. This substance is not currently one of the compounds for which a subregistry has been established in the National Exposure

## 5. POTENTIAL FOR HUMAN EXPOSURE

Registry. The substance will be considered in the future when chemical selection is made for subregistries to be established. The information that is amassed in the National Exposure Registry facilitates the epidemiological research needed to assess adverse health outcomes that may be related to exposure to this substance.

### 5.7.2 Ongoing Studies

As part of the Third National Health and Nutrition Evaluation Survey (NHANES III), the Environment Health Laboratory Sciences Division of the National Center for Environment Health, Centers for Disease Control and Prevention, will be analyzing human urine samples for chloroform (Needham et al. 1990). These data will give an indication of the frequency of occurrence and background levels of these compounds in the general population.

Research at Colorado State University (FEDRIP 1994) will investigate toxicity and bioaccumulation potential of chloroform and other organic and inorganic chemicals. The laboratory studies will use a simple food chain containing larval invertebrates and fish. The results would be applicable to many natural systems with fish foraging on insect larvae in contaminated sediments.

Another research project at Colorado State University (FEDRIP 1994) will study the microbial degradation kinetics of pollutant mixtures, which will include chloroform. One aspect of this research will focus on both the degradation of chloroform as well as its inhibitory effects when present above certain threshold concentrations.

A project at the University of Arizona (FEDRIP 1996) will study microbial dehalogenation of several compounds, including chloroform. A major part of the study will focus on the facultative anaerobic bacteria *Shewanella putrefaciens* sp., which is known to catalyze the transformation of carbon tetrachloride to chloroform and other as yet unidentified products. The organic substrates will also contain metals. It is hoped that the end-products from the biochemical treatment can be subjected to a photolytic finishing process that will completely mineralize any remaining halogenated compounds.

A project at the University of Idaho (FEDRIP 1996) will study the biodegradation of several halogenated hydrocarbons in soils amended with plant residues from various Brassica cultivars (e.g., rape seed). These residues contain chemicals that may help catalyze the degradation of some



## 5. POTENTIAL FOR HUMAN EXPOSURE

chlorinated hydrocarbons. Work to date has shown the potential for phorphyrins metallated with cobalt or nickel to cause the breakdown of carbon tetrachloride into such products as chloroform, dichlormethane, and carbon monoxide.

A project at the University of California at Berkeley (FEDRIP 1996) will study factors affecting the rates of degradation for several chlorinated hydrocarbons by soil microbial populations. Chloroform will be included as one of the organic chemicals studied.

A project conducted by the USDA (FEDRIP 1996) at its Western Regional Research Center in Albany, California, will study the use of ozone or peroxide treatment as an alternative to chlorinated bleaching in the preparation of walnuts intended for in-the-shell sales. There are concerns that the current use of hypochlorite bleaching agents can adversely impact taste as well as leaving behind THM residues containing chloroform.

A project at the University of California at Riverside (FEDRIP 1996) will study factors affecting the biodegradation in soils of several pesticides and halogenated organics by such microbes as *Methanobacterium thermoautotrophicum*. This anaerobic bacterium shows the potential for very rapid oxidation of several organics, including chloroform. In practice, however, one or more limiting factors dramatically reduces the expected degradation kinetics.

A project at the USDA's Western Research Center in Albany, California, will study ways to reduce exposures to chloroform for workers at poultry processing plants (FEDRIP 1994). At various points in the processing of poultry, the carcasses are rinsed in chiller-water baths that kill pathogens. Currently, chlorine is the only USDA-approved sanitizing agent. This study will investigate the potential of such alternative agents as chlorine dioxide to achieve comparable germicidal effects while reducing the levels of chloroform generated.

The United States Geological Survey (FEDRIP 1996) is conducting a study on the Mississippi River and its major tributaries focused on the transport and degradation of organic substances. Experiments will be conducted at 12 stations to determine the THM and organic halide formation potentials. The results will be summarized in a chapter on water purification by-products in a Report to Congress on the Mississippi River.

## 5. POTENTIAL FOR HUMAN EXPOSURE

Remedial investigations and feasibility studies at NPL sites that contain chloroform will also provide further information on environmental concentrations and human exposure levels near waste sites.



## 6. ANALYTICAL METHODS

The purpose of this chapter is to describe the analytical methods that are available for detecting and/or measuring and monitoring chloroform in environmental media and in biological samples. The intent is not to provide an exhaustive list of analytical methods that could be used to detect and quantify chloroform. Rather, the intention is to identify well established methods that are used as the standard methods of analysis. Many of the analytical methods used to detect chloroform in environmental samples are the methods approved by federal organizations such as EPA and the National Institute for Occupational Safety and Health (NIOSH). Other methods presented in this chapter are those that are approved by groups such as the Association of Official Analytical Chemists (AOAC) and the American Public Health Association (APHA). Additionally, analytical methods are included that refine previously used methods to obtain lower detection limits, and/or to improve accuracy and precision.

### 6.1 BIOLOGICAL SAMPLES

Methods for analyzing chloroform in the biological matrices (breath, blood, urine, and tissues) are listed in Table 6-1. None of these methods has been standardized by an organization or federal agency, although the blood method of Ashley et al. (1992) was developed at the Centers for Disease Control and Prevention (CDC). Sample preparation methods are based on headspace analysis, purgeand-trap, or solvent extraction. Sample preparation for breath samples typically utilizes an adsorbent followed by thermal desorption or direct analysis of an aliquot of breath. These methods all use gas chromatography (GC) with various detection methods as an analytical technique. Cardinali et al. (1994) describe a procedure for the production of blank water for use with analysis of organic compounds in human blood at the parts per trillion (ppt) level; the availability of such blank samples is very important if reliable results are to be obtained. With limits of detection (LODs) in the low-ppt range, these methods are sufficiently sensitive to measure background levels of chloroform in the general population as well as chloroform levels at which health effects might occur after short-term or long-term exposure. However, many studies do not report the method detection limit and/or the recovery percentage for the method. For more information regarding the use of GC methods and detectors, see Section 6.2.

Table 6-1. Analytical Methods for Determining Chloroform in Biological Samples

Sample matrix	Preparation method	Analytical method	Sample detection limit	Percent recovery	Reference
Exhaled air (breath)	Collection in Tedlar bag; preconcentration by Tenax-GC; thermal desorption	HRGC/FID and HRGC/MS	No data	No data	Krotoszynski et al. 1979
Alveolar air	Collection of exhaled air using a specially-designed device to provide pure air for inhalation. Breath collected into duplicate evacuated canisters.	GC/MS	0.5 $\mu\text{g}/\text{m}^3$ (0.5 ppt, w/v)	112 (8% RSD) at 5.1 $\mu\text{g}/\text{m}^3$	Raymer et al. 1990
Alveolar air	Collection directly into an evacuated canister	GC/MS	No data	No data	Pleil and Lindstrom 1995
Exhaled air	Collection of whole breath into a sampling bag; collected sample pulled through a Tenax cartridge	GC/Electrolytic conductivity	13 ng on cartridge	63 $\pm$ 13	Jo et al. 1990
Alveolar air	Collection onto carbonaceous sorbent; thermal desorption	GC/ITMS	No data	No data	Phillips and Greenberg 1992
Alveolar air	Collection of end-expired air into glass tube	GC/ECD, GC/MS	8.4 nmol/ $\text{m}^3$ (1 $\mu\text{g}/\text{m}^3$ ; 1 ppt, w/v)	No data	Aggazzotti et al. 1993
Whole blood	Purge-and-trap pre-concentration (with isotopically-labelled internal standard)	GC/Isotope dilution MS	0.040 ppb	105 at 0.054 ppb	Ashley et al. 1992
Whole blood	Headspace analysis	GC/FID	0.02 $\mu\text{g}/\text{mL}$ (0.02 ppm, w/v)	No data	Seto et al. 1993
Whole blood	Purge-and-trap preconcentration; thermal desorption	GC/MS	<0.5 $\mu\text{g}/\text{L}$	No data	Antoine et al. 1986
Adipose tissue and serum	Purge-and-trap pre-concentration; thermal desorption	GC/Hall with GC/MS confirmation	No data	100 at 0.6 $\mu\text{g}/\text{L}$ (serum); No data (tissue)	Peoples et al. 1979

**Table 6-1. Analytical Methods for Determining Chloroform in Biological Samples (continued)**

Sample matrix	Preparation method	Analytical method	Sample detection limit	Percent recovery	Reference
Whole blood	Solvent extraction	HRGC/ECD with HRGC/MS confirmation	No data	99 at 50 µg/L	Kroneld 1986
Serum and adipose tissue	Purge-and-trap pre-concentration; thermal desorption	GC/Hall with GC/MS confirmation	0.05 µg/L for serum	No data	Pfaffenberger et al. 1980
Water, serum, and urine	Solvent extraction	HRGC/ECD	1 µg/L for serum and urine	100.3 at 50 µg/L (water); 103 at 2.5 µg/L (serum); 141 at 2.3 µg/L (urine)	Reunanen and Kroneld 1982
Blood, urine	Blood collected into vacutainers containing EDTA. Two-mL aliquots of blood or urine dispensed into headspace vials for analysis	Headspace GC/ECD	No data	No data	Cammann and Hübner 1995
Blood, urine, and tissues	Addition of sample to internal standard; addition of proteolytic enzyme; equilibration at elevated temperature; analysis of headspace gas	GC/ECD	At least 1 ppm	No data	Streete et al. 1992
Blood, urine, and tissue	Purge-and-trap pre-concentration; thermal desorption	GC/HSD or GC/MS	0.10 µg/L (blood and urine)	No data	EPA 1985a

ECD = electron capture detector; FID = flame ionization detector; GC = gas chromatography; Hall = Hall electrolytic conductivity detector; HRGC = high-resolution gas chromatography; HSD = Halogen-specific electrolytic conductivity conductor; MS = mass spectrometry; RSD = relative standard deviation; w/v = weight:volume

## 6. ANALYTICAL METHODS

Chloroform is transformed by mammalian P-450 enzymes *in vivo* to trichloromethanol which undergoes spontaneous dechlorination to yield phosgene ( $\text{COCl}_2$ ) (Pohl et al. 1977), a highly reactive electrophile (Mansuy et al. 1977). Phosgene can react with cysteine to form 2-oxothiazolidine-4-carboxylic acid (Pohl et al. 1977, 1980b), with two molecules of glutathione to form diglutathionyl dithiocarbonate (Pohl et al. 1981), or with water to produce chloride ion and carbon dioxide (Pohl et al. 1980b). Although 2-oxothiazolidine-4-carboxylic acid and diglutathionyl dithiocarbonate have been measured in liver microsomal preparations (Pohl et al. 1977, 1980b, 1981), the applicability of these methods to human tissues is unknown. Phosgene can also be formed from bromotrichloromethane and carbon tetrachloride (Pohl et al. 1981), so the formation of phosgene and any subsequent products cannot be related exclusively to exposure to chloroform.

### 6.2 ENVIRONMENTAL SAMPLES

Analytical methods for determining chloroform in environmental samples are presented in Table 6-2. As with all extremely volatile chemicals, it is essential to take precautions during sampling, storage, and analysis to avoid loss of chloroform. Methods commonly used for the determination of chloroform concentrations in air are based on either adsorption onto a sorbent column followed by thermal or solvent desorption with subsequent analysis using GC (EPA 1988f; NIOSH 1994; OSHA 1979) or on cryogenic concentration of chloroform directly from a parcel of air (Bureau International Technique des Solvants Chlores 1976; EPA 19888, 19881) followed by GC. The disadvantages of the sorption tubes are that sorption and desorption efficiencies may not be 100%, and that the background impurities in the sorbent tubes may limit the detection limit for samples at low concentrations (Cox 1983). In addition, storage of sorbent tubes before desorption and analysis can result in losses of chloroform (OSHA 1979), and poor retention of chloroform by the sorbent can result in poor LODs (EPA 1988h). Determination of chloroform using isolation methods based on cryogenic trapping can be limited by moisture condensation in the trap (EPA 1988g). Evacuated canisters used to collect air samples in the field for transport to the laboratory must be carefully cleaned to avoid contamination of the sample (EPA 1988i).

Solid phase microextraction (SPME) has been shown to be useful for the determination of chloroform in air (Chai and Pawliszyn 1995). This technique is based upon the absorption of chloroform into a polymer coated on a silica fiber. Following equilibration of the fiber with the atmosphere, chloroform is released via thermal desorption in the injection port of a gas chromatograph. Sample preparation is

**Table 6-2. Analytical Methods for Determining Chloroform in Environmental Samples**

Sample matrix	Preparation method	Analytical method	Sample detection limit	Percent recovery	Reference
Air	Adsorption onto carbon molecular sieve; thermal desorption	GC/MS (EPA Method TO2)	No data	91 (15% RSD) at 89 ng/L	EPA 1988f
Air	Cryogenic preconcentration; thermal transfer to GC	GC/ECD (EPA Method TO3)	No data	100 (5.8% RSD) at 3.5 ppb	EPA 1988g
Air	Collection into SUMMA polished canister	GC/FID/ECD or GC/MS (EPA Method TO14)	No data	No data	EPA 1988i
Air	Adsorption onto charcoal; desorption with carbon disulfide	GC/FID (OSHA Method 05)	0.11 ppm for 10 L sample	96 (8.5% RSD)	OSHA 1979
Air	Adsorption onto charcoal; desorption with carbon disulfide, containing internal standard if desired	GC/FID (NIOSH method 1003)	0.7 mg/m <sup>3</sup> for 15 L sample	97 at 120–493 mg/m <sup>3</sup>	NIOSH 1994
Ambient air and stacks	Adsorption onto Tenax; thermal desorption	GC/FID or ECD	No data	No data	Parsons and Mitzner 1975
Air	Collection in flask; transfer to GC by syringe	GC/ECD	1.5 µg/m <sup>3</sup>	No data	Bureau International Technique des Solvants Chlores 1976
Air	Solid Phase Microextraction; transfer to GC via thermal desorption of fiber.	GC/ion trap MS	2 ppb (v/v); 6% RSD	No data	Chai and Pawliszyn 1995
Air	Exposure of passive sampler (3M 3500 OVM) for four weeks. Extraction with carbon disulfide.	GC/ECD/FID	4 ng/m <sup>3</sup>	98 (10.0% inter-day RSD)	Begerow et al. 1995



Table 6-2. Analytical Methods for Determining Chloroform in Environmental Samples (continued)

Sample matrix	Preparation method	Analytical method	Sample detection limit	Percent recovery	Reference
Air (phosgene)	Phosgene collection in an impinger containing a solution of aniline (forming carbanilide); evaporation of solvent; dissolution of residue in acetonitrile	HPLC/UV (EPA Method TO6)	0.1 ppb (v/v)	100 at 3 ppb (v/v); 15% RSD	EPA 1988n
Air (phosgene)	Phosgene collection onto Chromosorb coated with 1-(2-pyridyl)-piperazine; elution of derivative with acetonitrile	HPLC/UV	0.005 ppm (w/v)	100 over range 0.02–1 ppm (w/v)	Rando et al. 1993
Air (phosgene)	Passage of air through a tube filled with magnesium perchlorate (for water removal); cryogenic trapping	GC/ECD	7 ppt (v/v)	No data	Bächmann and Polzer 1989
Air, water	Solid phase microextraction (from air, water, or headspace over water)	GC/ECD	0.9 ppb (v/v) gas phase; 30 ng/L (30 ppt, w/v) liquid phase	No data	Chai et al. 1993
Drinking water	Direct injection or purge-and-trap pre-concentration	GC/ECD, GC/Hall	1 µg/L (1 ppb, w/v direct); 0.1 µg/L (0.1 ppb, w/v with purge-and-trap)	103–126 at 35–70 µg/L (direct); 91–106 at 35–70 µg/L (purge-and-trap)	Nicholson et al. 1977
Drinking water	Purge-and-trap pre-concentration; thermal desorption	GC/MS	0.1 µg/L (0.1 ppb, w/v)	No data	Coleman et al. 1976
Drinking water	Direct injection	GC/MS	0.1 µg/L (0.1 ppb, w/v)	No data	Fujii 1977

Table 6-2. Analytical Methods for Determining Chloroform in Environmental Samples (continued)

Sample matrix	Preparation method	Analytical method	Sample detection limit	Percent recovery	Reference
Seawater and freshwater	Solvent extraction with pentane; extract dried with sodium sulfate	GC/ECD	80 ng/L (0.08 ppb, w/v)	No data	Bureau International Technique des Solvants Chlores 1976
Water	Permeation through a silicon polycarbonate membrane into an inert gas stream and into GC port	GC/FID	74.0 µg/L (74 ppb, w/v)	No data	Blanchard and Hardy 1986
Drinking water	Acidification and dechlorination; extraction with methyl-t-butyl ether; direct injection of extract	GC/ECD or GC/MS (EPA Method 551)	0.002 µg/L (0.002 ppm, w/v)	100 (13% RSD) at 0.005 µg/L	EPA 1990g
Drinking water, waste water	Purge-and-trap pre-concentration; thermal desorption	GC/MS (Standard Method 6210)	< 0.1 µg/L (reagent water) using narrow bore capillary column	105 (3% RSD) narrow bore column	Greenberg et al. 1992
Tap water	Solvent extraction	HRGC/ECD with HRGC/MS confirmation	No data	No data	Kroneld 1986
Water	Solvent extraction	HRGC/ECD	1 µg/L (ppb, w/v)	100.3 at 50 µg/L	Reunanen and Kroneld 1982
Drinking water	Purge-and-trap pre-concentration onto Tenax/silica/charcoal; thermal desorption	GC with PID and Hall in series	0.02 µg/L	98 (2.5% RSD)	Ho 1989
Finished drinking/raw source water	Purge-and-trap pre-concentration onto Tenax/silica/charcoal; thermal desorption	GC/Hall (EPA method 502.1)	No data	0.90C+3.44 where C = true concentration (µg/L)	EPA 1991a

Table 6-2. Analytical Methods for Determining Chloroform in Environmental Samples (continued)

Sample matrix	Preparation method	Analytical method	Sample detection limit	Percent recovery	Reference
Finished drinking/raw source water	Purge-and-trap pre-concentration onto Tenax/silica/charcoal; thermal desorption	GC with PID and HSD in series (EPA method 502.2)	0.10 µg/L (0.1 ppb, w/v)	98 (2% RSD)	EPA 1991b
Finished drinking/raw source water	Purge-and-trap pre-concentration onto Tenax/silica/charcoal; thermal desorption	Subambient programmable HRGC/MS (EPA method 524.1)	0.2 µg/L (0.2 ppb, w/v)	103 at 1.0 µg/L	EPA 1991c
Finished drinking/raw source water	Purge-and-trap pre-concentration onto Tenax/silica/charcoal; thermal desorption	Cryofocusing (wide or narrow bore); HRGC/MS (EPA method 524.2)	0.03 µg/L (0.03 ppb, w/v) with wide bore column; 0.02 µg/L (0.02 ppb, w/v) with narrow bore column	90 (6.1% RSD) at 0.5–10 µg/L (wide bore); 95 (3.2% RSD) at 0.1 µg/L with narrow bore column	EPA 1992a
Groundwater, liquid, and solid matrices	Direct injection of head-space gas (EPA method 5020) or purge-and-trap pre-concentration and thermal desorption (EPA method 5030)	GC/HSD (EPA method 8010)	0.5 µg/L (ppb, w/v) for groundwater, 0.5 µg/g (ppm, w/w) for low-level soil, 500 µg/L (ppb, w/v) for water-miscible liquid waste, 1,250 µg/g (ppm, w/w) for soil, sludge, and non-water-miscible waste	Water: 0.93C -0.39 where C = true concentration in µg/L.	EPA 1986a
Waste water	Purge-and-trap pre-concentration; thermal desorption	GC/HSD or MS (EPA methods 601 and 624)	0.05 µg/L (for HSD); 1.6 µg/L (for MS)	102 at 0.44–50 µg/L (for HSD); 101 at 10–100 µg/L (for MS)	EPA 19982a

**Table 6-2. Analytical Methods for Determining Chloroform in Environmental Samples (continued)**

Sample matrix	Preparation method	Analytical method	Sample detection limit	Percent recovery	Reference
Solid and liquid waste, soil	Dispersion in glycol; purge-and-trap pre-concentration onto Tenax/ silica/charcoal; thermal desorption	GC/ECD and FID in series	No data	105 at 5 µg/L	Lopez-Avila et al. 1987
Sediment	Extraction into methanol; dilution with water; purge-and-trap pre-concentration	GC/FID/ECD	0.1 µg/g (0.1 ppm, w/w)	99 (4% RSD) at 0.8 µg/mL (0.8 ppm, w/v)	Amaral et al. 1994
Bulk oils	Purge-and-trap pre-concentration (with deuterated internal standards) onto Tenax; thermal desorption	GC/MS	1 ppb (w/v)	88 (6.7% RSD) at 93 ppb	Thompson 1994
Food	Extraction of composited, table-ready food with isooctane or acetone-isooctane; micro-Florisil clean-up (if fat content 21–70%); direct injection into GC	GC-ECD/Hall	5 ng/g (ECD); 5 ng/g (Hall)	15–161	Daft 1988a, 1989
Volatile food components	Direct injection of head-space gas	GC/ECD or MS	4.2 µg/kg (4.2 ppb, w/w in beverages); 12.5 µg/kg (12.5 ppb, w/w in dairy products); 18 µg/kg (meats); 28 µg/kg (fats/oils)	No data No data No data No data	Entz et al. 1982

ECD = electron capture detector; EPA = Environmental Protection Agency; FID = flame ionization detector; GC = gas chromatography; Hall = Hall electrolytic conductivity detector; HPLC/UV = high performance liquid chromatography with ultraviolet absorbance detection; HRGC = high-resolution gas chromatography; HSD = halogen-specific electrolytic conductivity detector; MS = mass spectrometry; NIOSH = National Institute for Occupational Safety and Health; OSHA = Occupational Safety and Health Administration; PID = photo-ionization detector; RSD = relative standard deviation; v/v = volume/volume; w/v = weight/volume

## 6. ANALYTICAL METHODS

very easy and fast (90 seconds for chloroform) with this technique although sample collection conditions and thermal desorption conditions must be carefully controlled for the best precision. Samples containing very volatile analytes, like chloroform, must be analyzed quickly after sample collection to avoid analyte loss with storage.

Phosgene has been identified as an atmospheric decomposition product of several chlorinated compounds, including chloroform (Bachmann and Polzer 1989). Phosgene can be determined in air samples using, for example, capillary GC with electron capture detection (ECD) (Bachmann and Polzer 1989), high-performance liquid chromatography (HPLC) after the conversion of phosgene to carbanilide (EPA 1988n), and HPLC after the reaction of phosgene with 1-(2-pyridyl)-piperazine (Rando et al. 1993). Chloroformates can interfere in the carbanilide analysis (EPA 1988n). In the method of Rando et al. (1993), the apparent recovery of phosgene was nearly quantitative from air at up to 25% relative humidity; this decreased to about 65% at 95% humidity.

The most common method for the determination of chloroform levels in water, sediment, soil, and foods is the purging of the vapor from the sample, or its suspension in a solvent with an inert gas and trapping (purge-and-trap) the desorbed vapors onto a sorbent trap (EPA 1991 a, 1991b, 1991c, 1992; Greenberg et al. 1992; Ho 1989; Lopez-Avila et al. 1987). SPME is a method that combines the ease of headspace analysis with some of the concentration benefits of purge-and-trap (Chai et al. 1993). Subsequent thermal desorption is used for the quantification of chloroform concentrations. Solvent extraction is also used in a number of methods (Amaral et al. 1994; Daft 1988a, 1989; EPA 1990g; Kroneld 1986; Reunanen and Kroneld 1982). No methods were found for phosgene in water, sediment, soil, and foods.

All of the methods listed above for the analysis of environmental samples use GC with various detection methods. The two methods that provide the lowest detection limits are halide-specific detectors (e.g., Hall electrolytic conductivity detector or electron capture detector) and the mass spectrometer (EPA 1986a; Ho 1989; Lopez-Avila et al. 1987; Ramus et al. 1984). The advantage of halide specific detectors is they are not only very sensitive, but are also specific for halide compounds. The mass spectrometer, on the other hand, provides additional confirmation of the presence of a compound through its ionization pattern and is desirable when a variety of compounds are required to be identified and quantified. The disadvantage of halide-specific detectors is their inability to detect and quantify nonhalogen compounds, if nonhalogenated compounds are of interest also; this can be

## 6. ANALYTICAL METHODS

greatly overcome by using other detectors (e.g., photoionization detector) in series (Lopez-Avila et al. 1987). High-resolution gas chromatography (HRGC) with capillary columns coupled with mass spectrometry (MS) provides better resolution and increased sensitivity for volatile compounds than packed columns. In methods such as EPA method TO14 (EPA 1985i), desorbed compounds are cryogenically trapped onto the head of the capillary column. Such HRGC/MS methods overcome some common problems involved in analyses of excessively complex samples, samples with large ranges of concentrations, and samples that also contain high-boiling compounds (Dreisch and Munson 1983; EPA 1986a). LODs in the sub-parts per billion (ppb) range are routinely possible in both air and liquid/solid matrices. Numerous standard methods exist.

Methods for rapid sample introduction to an ion trap mass spectrometer have been developed for the determination of organic compounds, including chloroform, in aqueous samples. In the method of Bauer and Solyom (1994) a polymeric membrane is placed into contact with the sample, the organics dissolve in the membrane and diffuse to the other side where they are swept directly into the mass spectrometer. This technique, known as membrane introduction mass spectrometry (MIMS) was shown to be sensitive to chloroform in water to 0.025 ppb. Another sample introduction technique known as inertial spray extraction nebulizes an aqueous sample (water, blood) into a small chamber where a countercurrent stream of helium sweeps any released volatile organic compounds (VOCs) into a jet separator at the inlet of an ion trap mass spectrometer (St-Germain et al. 1995). Up to 1 mL of sample can be introduced and the released VOCs are detected by the MS. Although both of these techniques provide for high throughput, no separation step is employed and this can result in interferences from ions formed by compounds other than the target analytes. These methods have great utility in selected applications.

A fiber-optic device has been described that can monitor chlorinated hydrocarbons in water (Gobel et al. 1994). The sensor is based on the diffusion of chlorinated hydrocarbons into a polymeric layer surrounding a silver halide optical fiber through which is passed broad-band mid-infrared radiation. The chlorinated compounds concentrated in the polymer absorb some of the radiation that escapes the fiber (evanescent wave); this technique is a variant of attenuated total reflection (ATR) spectroscopy. A LOD for chloroform was stated to be 5 mg/L (5 ppm). This sensor does not have a high degree of selectivity for chloroform over other chlorinated aliphatic hydrocarbons, but appears to be useful for continuous monitoring purposes.

## 6. ANALYTICAL METHODS

The reproducibilities of the methods listed in Table 6-2 are generally acceptable, but will vary, depending on the laboratories doing the analyses. Probable interferences for the methods of analysis include contamination from chloroform vapors in the laboratory. For this reason, it is often recommended that the laboratories doing the analysis should not contain chloroform or any other solvent to be measured in the sample (EPA 1986a). Plastic or rubber system components should be avoided as they can contaminate a sample or result in carryover from one analysis to the next (EPA 1992). The formation of aerosols and foam during purge-and-trap of liquid samples can contaminate the analytical system, so precautions must be taken (Thompson 1994; Vallejo-Cordoba and Nakai 1993). The use of field blanks is extremely important to correct for chloroform that might have diffused into the sample during shipping and storage (EPA 1986a). Other interferences include those volatile compounds that have similar retention times in the various GC columns used. This problem is often eliminated by analyzing the samples with two different types of GC columns such that the retention times will not be coincidental in both columns. Mass spectrometric detection can also help to overcome interferences resulting from incomplete chromatographic resolution. Refer to the references cited in Table 6-2 and the text for specific information regarding reproducibility and potential interferences.

### 6.3 ADEQUACY OF THE DATABASE

Section 104(i)(5) of CERCLA directs the Administrator of ATSDR (in consultation with the Administrator of EPA and agencies and programs of the Public Health Service) to assess whether adequate information on the health effects of chloroform is available. Where adequate information is not available, ATSDR, in conjunction with NTP, is required to assure the initiation of a program of research designed to determine the health effects (and techniques for developing methods to determine such health effects) of chloroform.

The following categories of possible data needs have been identified by a joint team of scientists from ATSDR, NTP, and EPA. They are defined as substance-specific informational needs that if met would reduce or eliminate the uncertainties of human health assessment. This definition should not be interpreted to mean that all data needs discussed in this section must be filled. In the future, the identified data needs will be evaluated and prioritized, and a substance-specific research agenda will be proposed.

## 6. ANALYTICAL METHODS

### 6.3.1 Identification of Data Needs

**Methods for Determining Biomarkers of Exposure and Effect.** Methods are available for the determination of chloroform in breath (Aggazzotti et al. 1993; Jo et al. 1990; Krotoszynski et al. 1979; Phillips and Greenberg 1992; Pleil and Lindstrom 1995; Raymer et al. 1990), blood (Antoine et al. 1986; Ashley et al. 1992; Cammann and Htibner 1995; EPA 1985a; Kroneld 1986; Peoples et al. 1979; Pfaffenberger et al. 1980; Reunanen and Kroneld 1982; Seto et al. 1993; Streete et al. 1992), and other fluids and tissues such as urine and adipose (Cammann and Htibner 1995; EPA 1985a; Peoples et al. 1979; Pfaffenberger et al. 1980; Reunanen and Kroneld 1982; Streete et al. 1992). Sub-ppb limits of detection have been shown (e.g., Ashley et al. 1992; Pfaffenberger et al. 1980) and the methods are adequate for the determination of chloroform concentrations in samples from the general population. No biomarker that can be associated quantitatively with chloroform exposure has been identified (see Sections 2.5.1 and 6.1). Although chloroform levels can be determined in biological samples, the relationship between these levels and the exposure levels has not been adequately studied. In one study, the concentrations of chloroform in alveolar air of people attending activities at an indoor swimming pool were found to be proportional to the concentrations in air (Aggazzotti et al. 1993). Such proportionality was observed, in part, because the alveolar air samples were taken soon after exposure termination. Good correlations have also been measured between chloroform concentrations measured in blood and breath with those in air or water after exposure to water/air during showering (Jo et al. 1990) and swimming (Cammann and Htibner 1995; Lévesque et al. 1994). The studies of Jo et al. (1990) and Lévesque et al. (1994) demonstrated and quantified the uptake of chloroform via dermal absorption. Correlations of alveolar air concentrations with exposure air concentrations based on breath samples at unknown postexposure times will be complicated by metabolism and other factors, such as activity, important in the elimination of chloroform from the body (see PBPK discussion, Chapter 2). Furthermore, the presence of chloroform, or a transformation product of chloroform such as phosgene and reaction products of phosgene, in a biological sample may have resulted from the metabolism of another chlorinated hydrocarbon. If a biomarker of exposure for this compound in a human tissue or fluid was available and a correlation between the level of the biomarker and exposure existed, it could be used as an indication of the extent of chloroform exposure. Further information regarding the accuracy of sample recovery for the methods of chloroform analysis would be useful in interpreting monitoring data.



## 6. ANALYTICAL METHODS

No biomarker of effect that can be associated quantitatively and directly to chloroform exposure has been identified (see Section 2.5.2). If biomarkers of effect were available for this compound and a correlation between the level or intensity of the biomarker of effect and the exposure level existed, it could be used as an indication of the levels and extent of chloroform exposure. However, in cases where an exposure to chloroform has been known to occur, measurements of chloroform in breath or blood can indicate body burden.

### **Methods for Determining Parent Compounds and Degradation Products in Environmental**

**Media.** Methods for determining chloroform in the environment are available. These include methods for drinking water (Blanchard and Hardy 1986; EPA 1990g, 1991a, 1991b, 1991c, 1992; Greenberg et al. 1992; Ho 1989; Kroneld 1986; Nicholson et al. 1977), air (Bergerow et al. 1995, Chai and Pawliszyn 1995, EPA 1988f, 1988g, 198831, 19881; NIOSH 1994; OSHA 1979; Parsons and Mitzner 1975), and foods (Daft 1988a, 1989; Entz et al. 1982; Thompson 1994). These three media are of most concern for human exposure. The precision, accuracy, reliability, and specificity of the methods are well documented and well suited for the determination of low levels of chloroform and levels at which health effects occur. For example, the MRL for acute-duration inhalation is 0.1 ppm (weight per volume [w/v] or  $0.0099 \text{ mg/m}^3$ ) so any method used must have a limit of detection equal to or less than this. The methods of Chai et al. (1993), Chai and Pawliszyn (1995), and Bergerow et al. (1995) report limits of detection of 0.9 ppb volume per volume (v/v), 2 ppb, and  $4 \text{ ng/m}^3$ , respectively, and are adequate for the measurement of chloroform in air. Although no limits of detection were reported for EPA methods TO2 and TO3 (EPA 1988f, 1988g), recoveries were acceptable for low-ppb concentrations of chloroform in air and thus these methods should certainly be applicable to concentrations at the acute-duration inhalation MRL. Similarly, the chronic-duration oral MRL is  $0.01 \text{ mg/kg/day}$ , which converts to  $0.7 \text{ mg/day}$  for a 70-kg person. For a 2 L/day water consumption, this translates into a required method limit of detection of  $0.35 \text{ mg/L}$ . This concentration is easily measured by the methods of EPA (1990g) (limit of detection  $0.002 \text{ } \mu\text{g/L}$ ), Greenberg et al. (1992) (limit of detection  $0.1 \text{ } \mu\text{g/L}$ ), and Chai et al. (1993) (limit of detection  $30 \text{ ng/L}$ ). Assuming a food intake of  $2 \text{ kg/day}$ , this oral MRL translates to a needed method limit of detection in food of  $0.35 \text{ mg/kg}$ . The methods of Entz et al. (1982) and Daft (1988a, 1989) provide limits of detection of less than  $0.028 \text{ mg/kg}$  and are adequate. Method sensitivities are clearly adequate for matrices in which the higher acute-duration oral MRL is of concern. There is not much information regarding the degradation products of chloroform in the environment. Although phosgene can be produced in the environment and its high reactivity suggests that it would not persist, several

## 6. ANALYTICAL METHODS

methods were found for the quantification of phosgene in ambient air (Bachmann and Polzer 1989; EPA 1988n; Rando et al. 1993). No methods were found for phosgene in other environmental matrices and it is not likely that it would be found in matrices other than air.

### 6.3.2 Ongoing Studies

The Environmental Health Laboratory Sciences Division of the Center for Environmental Health and Injury Control, Centers for Disease Control and Prevention, is developing methods for the analysis of chloroform and other VOCs in blood. These methods use purge-and-trap methodology, HRGC, and magnetic sector mass spectrometry which gives detection limits in the low-ppt range (see Ashley et al. 1992).

The following information was obtained from a search of Federal Research in Progress (FEDRIP, 1996). Researchers at Physical Sciences, Inc. are developing an imaging infrared spectrometer that can rapidly screen field sites to detect the presence of VOCs, including chloroform, from remote locations (either in the air or on the ground). The following research projects were identified as having objectives that might require the development or modification of methods to measure chloroform. Researchers at Colorado State University are studying the biodegradation of pollutants, including chloroform, in bioreactors. Researchers at the University of California at Berkeley and Riverside are conducting studies on the biodegradation of organic compounds, including chloroform, in soil.



## 7. REGULATIONS AND ADVISORIES

The international, national, and state regulations and guidelines regarding chloroform in air, water and other media are summarized in Table 7- 1.

An MRL of 0.1 ppm has been derived for acute-duration inhalation exposure to chloroform. The MRL is based on a NOAEL of 3 ppm for hepatic effects in mice (Larson et al. 1994c).

An MRL of 0.05 ppm has been derived for intermediate-duration inhalation exposure to chloroform. The MRL is based on a LOAEL of 14 ppm for toxic hepatitis in workers exposed to up to 400 ppm for less than 6 months (Phoon et al. 1983).

An MRL of 0.02 ppm has been derived for chronic-duration inhalation exposure to chloroform. The MRL was based on a LOAEL of 2 ppm for hepatic effects in workers exposed to concentrations of chloroform ranging from 2 to 205 ppm for 1-4 years (Bomski et al. 1967).

An MRL of 0.3 mg/kg/day has been derived for acute-duration oral exposure to chloroform. The MRL is based on a NOAEL of 26.4 mg/kg/day for hepatic effects in mice (Larson et al. 1994b).

An MRL of 0.1 mg/kg/day has been derived for intermediate-duration oral exposure to chloroform. The MRL is based on a NOAEL of 15 mg/kg/day for liver effects (increased SGPT) in dogs exposed to chloroform in toothpaste for  $\geq 6$  weeks (Heywood et al. 1979).

An MRL of 0.01 mg/kg/day has been derived for chronic-duration oral exposure to chloroform based on a LOAEL for liver effects (increased SGPT) in dogs administered 15 mg/kg/day chloroform in toothpaste in capsules for 7.5 years (Heywood et al. 1979).

The chronic-duration oral reference dose (RfD) for chloroform is also 0.01 mg/kg/day, based on the LOAEL for liver effects in dogs administered 15 mg/kg/day chloroform (Heywood et al. 1979; IRIS 1996).

No reference concentration (RfC) exists for the compound.

## 7. REGULATIONS AND ADVISORIES

The EPA has determined that chloroform is a probable human carcinogen; corresponding group B2 (IRIS 1996). Gavage studies conducted by the NTP were positive for carcinogenicity in female mice and male mice and rats, but negative for female rats (NTP 1995).

The International Agency for Research on Cancer (IARC) has determined that chloroform is possibly carcinogenic to humans; Group 2B classification (IARC 1987).

Chloroform is regulated by the Clean Water Act Effluent Guidelines for the following industrial point sources: electroplating; organic chemicals; steam electric, asbestos, and timber products processing; paving and roofing; paint and formulating; formulating; gum, wood and carbon black; metal molding, casting, and finishing; coil coating; copper forming; and electrical and electronic components (EPA 1981a).

## 7. REGULATIONS AND ADVISORIES

**Table 7-1. Regulations and Guidelines Applicable to Chloroform**

Agency	Description	Information	References
<u>INTERNATIONAL</u>			
Guidelines:			
IARC	Carcinogenic classification	Group 2B <sup>a</sup>	IARC 1987
WHO	Drinking water guidelines	30 µg/L	WHO 1984
<u>NATIONAL</u>			
Regulations:			
a. Air:			
EPA OAQPS	Intent to list under Section 112 of Clean Air Act	Yes	40 CFR 61.01 EPA 1985d
	New Source Performance Standards		
	Chemicals Produced at SOCMF Facilities	Yes	40 CFR 60.489 EPA 1983b
	Chemical Affected by Standards for SOCMF Distillation Operations	Yes	40 CFR 60.667 EPA 1990e
	National Emission Standards for Hazardous Air Pollutants		
	Hazardous Air Pollutants	Yes	40 CFR 61.01 EPA 1985d
	Proposed Rule: Identification of "More Hazardous" Emission Decreases	Yes	59 FR 15504 40 CFR 63.48 EPA 1994a
	Proposed Rule: National Emission Standards for Halogenated Solvent Clearing-Applicability	Yes	58 FR 62566 40 CFR 63.460 EPA 1993a
OSHA	PEL-TWA	50 ppm	29 CFR 1910 OSHA 1974
	Permissible Exposure Limit (Ceiling)	240 mg/m <sup>3</sup>	OSHA 1974
	Occupational Exposure to Hazardous Chemicals in Laboratories	Yes	OSHA 1974
b. Water:			
EPA	PQL	0.5 µg/L	40 CFR 264 and 270 EPA 1987a
	Effluent Guidelines and Standards		
	List of Toxic Pollutants	Yes	40 CFR 401.15 EPA 1979b
	List of Toxic Pollutants Subject to Pretreatment Standards	Yes	40 CFR 403, App. B EPA 1981a
	Definition of Total Toxic Organics (TTO) for Electroplating Point Source Category	Yes	40 CFR 413.02 EPA 1981b
	Bulk Organic Chemicals in Wastewater from Sources of Organic Chemicals, Plastics and Synthetic Fibers	Yes	40 CFR 414.70 EPA 1987e

## 7. REGULATIONS AND ADVISORIES

**Table 7-1. Regulations and Guidelines Applicable to Chloroform (continued)**

Agency	Description	Information	References	
NATIONAL (cont.)	Organic Chemicals, Plastics, and Synthetic Fibers - Effluent Limitations for Direct Discharge Point Sources Using End-of-Pipe Biological Treatment		40 CFR 414.91 EPA 1987e	
	One-day maximum	46 µg/L		
	Maximum for monthly average	21 µg/L		
	Organic Chemicals, Plastics, and Synthetic Fibers - Effluent Limitations for Direct Discharge Point Sources That Do Not Use End-of-Pipe Biological Treatment		40 CFR 414.101 EPA 1987e	
	One-day maximum	325 µg/L		
	Maximum for monthly average	111 µg/L		
	Priority Pollutants, Associated With Steam Electric Power Generating Sources	Yes		40 CFR 423, App. A EPA 1982b
	Proposed Rule: Effluent Limitations for Pulp, Paper, and Paperboard - Dissolving Kraft (bleach plant effluent)			58 FR 66078 40 CFR 430 EPA 1993d
			1-Day Max.	Monthly Avg.
	Existing BAT New Source Pretreatment	10.1 g/kg 10.1 g/kg	7.06 g/kg 7.07 g/kg	
	Bleached paper grade kraft and soda (bleach plant effluent - existing BAT and pretreatment for existing)	5.06 g/kg	2.01 g/kg	
	Dissolving sulfite - pretreatment for new sources	23.2 g/kg	74.4 g/kg	
	Proposed Rule: Monitoring Requirements for Pulp, Paper, and Paperboard Category	Yes		59 FR 12567 40 CFR 430.02 EPA 1994c
Definition of TTO for Metal Finishing Sources	Yes		40 CFR 433.11 EPA 1983d	
Definition of TTO for Metal Molding and Casting Sources	Yes		40 CFR 464.21 EPA 1985e	
Definition of TTO for Ferrous Casting Sources			40 CFR 464.31 EPA 1985e	
Definition of TTO for Coil Coating Sources	Yes		40 CFR 465.02 EPA 1982c	
EPA ODW	National Primary Drinking Water Regulations			
	Definition of Trihalomethanes (THM)	Yes	40 CFR 141.2 EPA 1975	
	Maximum Contaminant Levels for THM	0.10 mg/L	40 CFR 141.12 EPA 1991f	
	Method of Analysis for THM	Yes	40 CFR 141, App. C EPA 1979a	

## 7. REGULATIONS AND ADVISORIES

**Table 7-1. Regulations and Guidelines Applicable to Chloroform (continued)**

Agency	Description	Information	References
<u>NATIONAL (cont.)</u>	Monitoring for Inorganic and Organic Chemicals	Yes	40 CFR 141.40 EPA 1987d
	Proposed Rule: Total Trihalomethane Sampling and Analysis	Yes	58 FR 65622 40 CFR 141.30 EPA 1993c
	Proposed Rule: Maximum Contaminant Levels for Total THM	Yes	59 FR 38668 40 CFR 141.12 EPA 1994b
	Proposed Rule: Total THM Sampling, Analytical and Other Requirements	Yes	59 FR 38668 40 CFR 141.30 EPA 1994b
	Proposed Rule: Best Available Technology for Achieving Compliance with MCLs for Total THM	Yes	59 FR 38668 40 CFR 141.64 EPA 1994b
	Proposed Rule: Disinfection By-Product Compliance Monitoring for Total THM	Yes	59 FR 38668 40 CFR 141.133 EPA 1994b
EPA OW	Designation of Hazardous Substances	Yes	40 CFR 116.4 EPA 1978
	Reportable Quantities for Hazardous Substances	10 pounds	40 CFR 117.3 EPA 1986e
	National Pollutants Charge Elimination System: Permit Application Testing Requirements	Yes	40 CFR 122, App. D EPA 1983c
	Proposed Rule: Application of Part 132 Requirements to Great Lake States and Tribes - Pollutants of Initial Focus	Yes	58 FR 20802 40 CFR 132.6 EPA 1993b
	Test Procedures for the Analysis of Pollutants	Yes	40 CFR 136.3 EPA 1973
	Methods of Analysis of Municipal and Industrial Wastewater	Yes	40 CFR 136, App. A EPA 1973
c. Food:			
FDA	Substances used only as components of adhesives	Yes	21 CFR 175.105 FDA 1977
d. Other:			
EPA OERR	RQ (Ruled)	10 pounds	54 FR 155 EPA 1989c
	Threshold planning quantity	10,000 pounds	EPA 1987b
	Constituents for Solid Waste Detection Monitoring	Yes	40 CFR 258, App. I EPA 1991g
	Hazardous Constituents Subject to Regulatory Requirements	Yes	40 CFR 258, App. II EPA 1991g
	Maximum Concentration Contaminants for the Toxicity Characteristic	Yes	40 CFR 261.24 EPA 1990d



## 7. REGULATIONS AND ADVISORIES

Table 7-1. Regulations and Guidelines Applicable to Chloroform (continued)

Agency	Description	Information		References
NATIONAL (cont.)	Discarded commercial chemical products, off-specification species, container residues, and spill residues	Yes		40 CFR 261.33 EPA 1990d
	Basis for Listing Hazardous Waste	Yes		40 CFR 261, App. VII EPA 1981c
	Proposed Rule: Basis Listing Hazardous Waste	Yes		59 FR 9808 40 CFR 261, App. VII EPA 1994d
	Hazardous Constituents	Yes		40 CFR 261, App. VIII EPA 1988j
	Groundwater Monitoring List for Hazardous Waste TSDf	Yes		40 CFR 264, App. IX EPA 1991d
	Health Based Limits for Exclusion of Waste-Derived Residues	6x10 <sup>-2</sup>		40 CFR 266, App. VII EPA 1991d
	Potential PICs For Determination of Exclusion of Waste-Derived Residues	Yes		40 CFR 266, App. VIII EPA 1991d
EPA	Land Disposal Restrictions			
	Identification of Waste to Be Evaluated by August 8, 1988	Yes		40 CFR 268.10 EPA 1986f
	Constituent Concentrations Which May Not be Exceeded for Land Disposal			40 CFR 268.43 EPA 1988k
	Waste Code:	Waste water	Non-waste water	
	F025	0.046 mg/L	6.2 mg/kg	
	F039, K117, U044	0.046 mg/L	5.6 mg/kg	
	Halogenated organic compounds regulated under 40 CFR 268.32	Yes		40 CFR 268, App. III EPA 1987g
	Proposed Rule: Treatment Standards for Land Disposed Waste			58 FR 48092 40 CFR 268.40 & 268.48 EPA 1993e
	Waste Code:	Waste water	Non-waste water	
	D022, K019, K029, K150, K151, universal treatment standard	0.046 mg/L	6/9 mg/kg	
F025, K073	0.046 mg/L	6.2 mg/kg		
F038, K117, K118, K136, U044	0.046 mg/L	5.6 mg/kg		
K009, K010	0.1 mg/L	6.0 mg/kg		

## 7. REGULATIONS AND ADVISORIES

**Table 7-1. Regulations and Guidelines Applicable to Chloroform (continued)**

Agency	Description	Information	References
<u>NATIONAL (cont.)</u>	List of Hazardous Substances and Reportable Quantities	10 pounds	40 CFR 302.4 EPA 1989d
	Proposed Rule: Reportable Quantity Adjustments - Designation of Hazardous Waste	Yes	58 FR 54836 40 CFR 302.4 EPA 1993f
	Extremely Hazardous Substances and Threshold Planning Quantities	10,000 pounds	40 CFR 355, App. A EPA 1987h
	Chemicals Subject to Toxic Chemical Release Reporting: Community Right-to-Know	Yes	40 CFR 372.65 EPA 1988i
	Chemicals Subject to the Health and Safety Data Reporting Requirements Under TSCA	Yes	40 CFR 716.120 EPA 1988m
Guidelines:			
a. Air:			
ACGIH	TLV-TWA	10 ppm (49 mg/m <sup>3</sup> )	ACGIH 1992
	Threshold Limit Value for Occupational Exposure	49 mg/m <sup>3</sup>	ACGIH 1994
NIOSH	STEL (60 minutes)	2 ppm (9.78 mg/m <sup>3</sup> )	NIOSH 1990
	Recommended Exposure Limit for Occupational Exposure (STEL-60 min)	9.78 mg/m <sup>3</sup>	NIOSH 1992
	Immediately Dangerous to Life & Health	1,000 ppm	NIOSH 1990
b. Water:			
EPA	1-d Health Advisory	4 mg/L (child)	EPA 1994e
	10-d Health Advisory (child & adult)	4 mg/L (child)	EPA 1994e
	Longer-term Health Advisory (child & adult)	0.1 mg/L (child 0.4 mg/L (adult)	EPA 1994e
	Maximum Contaminant Level Chloroform	0.1 mg/L	EPA 1994e
	Total THM (community and non-transient, non-community water systems)	0.080 mg/L	59 FR 38668
	Total THM (serve more than 10,000 people)	0.040 mg/L	40 CFR 141.64 EPA 1994b
	Maximum Contaminant Level Goal	zero	59 FR 38668 40 CFR 141.53 EPA 1994b
	q <sup>1*</sup> cancer slope factor (oral exposure)	6.1x10 <sup>-3</sup> per mg/(kg/day)	IRIS 1996
	RfD (oral)	1.10 <sup>-2</sup> mg/kg/day (UF 1,000)	
EPA ODW	Individual lifetime cancer risk 10 <sup>-5</sup>	60 µg/L	
NAS	Suggested No-Adverse-Response Level		
	24-hour	22 mg/L	NAS 1980
	7-day	3.2 mg/L	

## 7. REGULATIONS AND ADVISORIES

**Table 7-1. Regulations and Guidelines Applicable to Chloroform (continued)**

Agency	Description	Information	References
<u>NATIONAL (cont.)</u>			
c. Non-specific media			
EPA	q <sub>1</sub> * (oral) q <sub>1</sub> * (inhalation)	6.1x10 <sup>-3</sup> (mg/kg/day) <sup>-1</sup> 8.1x10 <sup>-2</sup> (mg/kg/day) <sup>-1</sup> [2.3x10 <sup>-5</sup> (μg/m <sup>3</sup> ) <sup>-1</sup> ]	IRIS 1996
	RfD (chronic oral) Cancer classification	0.01 mg/kg/day B2 <sup>b</sup>	
d. Other			
EPA	Cancer classification	B2	
NIOSH	Cancer classification	Yes	NIOSH 1990 NIOSH 1992
Regulations and Guidelines:			
a. Air:			
AZ	Acceptable ambient air concentrations 1 hour 24 hours 1 year	60 μg/m <sup>3</sup> 16 μg/m <sup>3</sup> 0.043 μg/m <sup>3</sup>	NATICH 1992
CT	8 hours	250 μg/m <sup>3</sup>	
FL (Ft. Lauderdale)	8 hours	0.5 mg/m <sup>3</sup>	
FL (Pinellas Co.)	8 hours 24 hours 1 year	97.8 μg/m <sup>3</sup> 23.5 μg/m <sup>3</sup> 0.043 μg/m <sup>3</sup>	
IN	8 hours Annual	48.9 μg/m <sup>3</sup> 0.043 μg/m <sup>3</sup>	
IN (Innap)	8 hours	1200 μg/m <sup>3</sup>	
KS	1 year	0.0435 μg/m <sup>3</sup>	
KS-KC	Annual	0.0435 μg/m <sup>3</sup>	State of Kentucky 1986
LA	Annual	4.3 μg/m <sup>3</sup>	NATICH 1992
MA	24 hours 1 year	133 μg/m <sup>3</sup> 0.04 μg/m <sup>3</sup>	
ME	1 year	0.043 μg/m <sup>3</sup>	
MI	1 year	0.40 μg/m <sup>3</sup>	
NC	1 year	0.0043 mg/m <sup>3</sup>	
NC	1 year	0.0043 mg/m <sup>3</sup>	
ND		BACT	
NV	8 hours	1.19 mg/m <sup>3</sup>	
NY	1 year	167 μg/m <sup>3</sup>	
OK	24 hours	97 μg/m <sup>3</sup>	

## 7. REGULATIONS AND ADVISORIES

**Table 7-1. Regulations and Guidelines Applicable to Chloroform (continued)**

Agency	Description	Information	References
<u>STATE (cont.)</u>			
PA (Phil.)	1 year	120 $\mu\text{g}/\text{m}^3$	
RI	1 year	0.04 $\mu\text{g}/\text{m}^3$	
SC	24 hours	250 $\mu\text{g}/\text{m}^3$	
TX	30 minutes 1 year	98 $\mu\text{g}/\text{m}^3$ 10 $\mu\text{g}/\text{m}^3$	
VA	24 hours	490 $\mu\text{g}/\text{m}^3$	
VT	1 year	0.043 $\mu\text{g}/\text{m}^3$	
WA/SWEST	1 year	0.043 $\mu\text{g}/\text{m}^3$	
b. Water:			
	Water Quality: Human Health		FSTRAC 1990
AZ	Drinking water quality standards Domestic/ Drinking	0.49 $\mu\text{g}/\text{L}$ 5.7 $\mu\text{g}/\text{L}$	Sittig 1994
FL	Domestic/ Drinking	100 $\mu\text{g}/\text{L}$	
IL		1 $\mu\text{g}/\text{L}$	CELDs 1994
MA		5 $\mu\text{g}/\text{L}$	
MI	Domestic/ Drinking	5.6 $\mu\text{g}/\text{L}$	Sittig 1994
MN		57 $\mu\text{g}/\text{L}$	CELDs 1994
NJ	Domestic/ Drinking	6 $\mu\text{g}/\text{L}$	Sittig 1994
NY	Domestic/ Drinking	0.2-100 $\mu\text{g}/\text{L}$	
OR	Domestic /Drinking	10 $\mu\text{g}/\text{L}$	
RI	Drinking water standard	6-100 $\mu\text{g}/\text{L}$	CELDs 1994
TN	Domestic/ Drinking	100 $\mu\text{g}/\text{L}$	Sittig 1994
TX	Domestic/ Drinking	100 $\mu\text{g}/\text{L}$	
VT	Domestic/ Drinking	6 $\mu\text{g}/\text{L}$	
	Water Quality: Human Health		CELDs 1994
AZ	Domestic Water Source (DWS) Fish Consumption (FC) Full Body Contact (FBC) Partial Body Contact (PBC)	TTHM 590 $\mu\text{g}/\text{L}$ 230 $\mu\text{g}/\text{L}$ 1400 $\mu\text{g}/\text{L}$	
CO	MCL	0.10 mg/L	
CT	MCL	2.0 $\mu\text{g}/\text{L}$	
DC	Water Quality Criteria C D	3,000 mg/L 0.2 mg/L	
FL	MCL	0.10 mg/L	

## 7. REGULATIONS AND ADVISORIES

**Table 7-1. Regulations and Guidelines Applicable to Chloroform (continued)**

Agency	Description	Information	References
<u>STATE (cont.)</u>			
HI	Maximum organic contaminant level: Total trihalomethane (TTHM) (TTHM = the sum of the concentration of bromodichloromethane, dibromochloromethane and chloroform)	<u>Acute</u>	<u>Chronic</u>
	Fresh water	9,600 µg/L	ns
	Salt water	ns	ns
	Fish consumption	5.1	
IN	Outside of mixing zone	157 µg/L	
	Point of water intake	1.9 µg/L	
	MCL (TTHM)	0.10 mg/L	
KY	Consumption of fish	15.7 µg/L	
	MCL	0.19 µg/L	
KS	MCL (TTHM)	0.10 mg/L	
LA	Drinking water	5.30 µg/L	
	Non-drinking water	70.00 µg/L	
ME	Maximum level (TTHM)	0.10 mg/L	
NH	MCL (TTHM)	0.10 mg/L	
NM	Groundwater levels	0.1 mg/L	
NY	Groundwater effluent standard (max.)	7 µg/L	
ND	MCL (TTHM)	0.10 mg/L	
NC	MCL (TTHM)	0.10 mg/L	
	Water quality standard for class GS Groundwater	0.00019 mg/L	
OG	Groundwater quality reference level (TTHM)	0.100 mg/L	
	MCL (TTHM)	0.10 mg/L	
OK	Groundwater water quality criteria	10.0 (no units specified)	
	MCL (TTHM)	0.10 mg/L	
OH	MCL (TTHM)	0.10 mg/L	
SC	MCL (TTHM)	0.10 mg/L	
VT	Class A or B waters	0.19 mg/L	
	Class C water	15.7 mg/L	
WV	MCL (TTHM)	0.10 mg/L	
WI	Human cancer criteria: Public Water Supplier		
	Warm water sport fish communities	1.9 mg/L	
	Cold water communities	1.8 mg/L	
	Great Lakes communities	1.8 mg/L	
	Non-Public Water Supplies		
	Warm water sport fish communities	87 mg/L	
	Cold water communities	31 mg/L	
	Warm water forage and limited fish communities and limited aquatic life	380 mg/L	
	Groundwater Enforcement standard		
	Prevention action limit	6 µg/L	

## 7. REGULATIONS AND ADVISORIES

Table 7-1. Regulations and Guidelines Applicable to Chloroform (continued)

Agency	Description	Information	References
<u>STATE (cont.)</u>			
WV	All water use categories, maximum criteria B1, B2, B3 waters A	15.7 $\mu\text{g/L}$ 0.19 $\mu\text{g/L}$	
	Water Quality: Aquatic Life		CELDs 1994
AZ	Acute Criteria for Aquatic and Wildlife Uses Cold water fishery (A/W) Warm water fishery (A/W) Effluent dominated water (A/W) Ephemeral (A/W)	<u>Acute</u> 14,000 $\mu\text{g/L}$ 14,000 $\mu\text{g/L}$ 14,000 $\mu\text{g/L}$ NNS	<u>Chronic</u> 900 $\mu\text{g/L}$ 900 $\mu\text{g/L}$ 900 $\mu\text{g/L}$ NNS
CO	Aquatic Life Segments Acute Chronic	28,900 $\mu\text{g/L}$ 1,240 $\mu\text{g/L}$	
FL	MCL for mixing zone pollutants	1.57 mg/L	
LA	Acute Criteria Freshwater  Marine water	2,890 $\mu\text{g/L}$ -acute 1,445 $\mu\text{g/L}$ -chronic 8,150 $\mu\text{g/L}$ -acute 4,075 $\mu\text{g/L}$ -chronic	
OH	Outside mixing zone: maximum Inside mixing zone: maximum Cold water mixing zone: 30-day average  Groundwater Monitoring	1,800 $\mu\text{g/L}$ 3,600 $\mu\text{g/L}$ 79 $\mu\text{g/L}$	CELDs
AL		Yes	
CA		Yes	
CO		Yes	
IL		Yes	
KY		Yes	
LA		Yes	
MN		Yes	
MT		Yes	
NY		Yes	
OH		Yes	
SC		Yes	
TN		Yes	
VA		Yes	
WI		Yes	
WV		Yes	

## 7. REGULATIONS AND ADVISORIES

**Table 7-1. Regulations and Guidelines Applicable to Chloroform (continued)**

Agency	Description	Information	References
<u>STATE (cont.)</u>			
	Hazardous Constituents		CELDs
AL	Maximum Concentration of Contaminants for the Toxicity Characteristics	60 mg/L	
CA	Concentration in waste; non-RCRA solvent waste	2.0 mg/kg	
	Maximum concentration for the toxicity characteristics	6.0 mg/L	
CO	Maximum concentration for the toxicity characteristics	6.0 mg/L	
IL	Maximum concentration for the toxicity characteristics	6.0 mg/L	
KY	Maximum concentration for the toxicity characteristics	6.0 mg/L	
LA	Maximum concentration for the toxicity characteristics	6.0 mg/L	
MA	Maximum concentration for the toxicity characteristics	6.0 mg/L	
MD	Maximum concentration for the toxicity characteristics	6.0 mg/L	
ME	Maximum concentration for the toxicity characteristics	Yes	
MN	Maximum concentration for the toxicity characteristics	6.0 mg/L	
MT	Maximum concentration for the toxicity characteristics	6.0 mg/L	
ND	Maximum concentration for the toxicity characteristics	6.0 mg/L	
NH	Maximum concentration for the toxicity characteristics	Yes	
NJ	Maximum concentration for the toxicity characteristics	6.0 mg/L	
NY	Maximum concentration for the toxicity characteristics	Yes	
PA	Maximum concentration for the toxicity characteristics	6.0 mg/L	
OH	Maximum concentration for the toxicity characteristics	6.0 mg/L	
SC	Maximum concentration for the toxicity characteristics	6.0 mg/L	
TX	Maximum leachable concentration	6.0 mg/L	
VA	Maximum concentration for the toxicity characteristics	6.0 mg/L	

## 7. REGULATIONS AND ADVISORIES

**Table 7-1. Regulations and Guidelines Applicable to Chloroform (continued)**

Agency	Description	Information	References
<u>STATE (cont.)</u>			
VT	Maximum concentration for the toxicity characteristics	6.0 mg/L	
WI	Maximum concentration for the toxicity characteristics	6.0 mg/L	
WV	Maximum concentration for the toxicity characteristics	Yes	
WY	Maximum concentration for the toxicity characteristics	6.0 mg/L	

<sup>a</sup>Group 2B: Possible human carcinogen

<sup>b</sup>Group B2: Probable human carcinogen

ACGIH = American Conference of Governmental Industrial Hygienists; AW = Aquatic and Wildlife; BAT = Best Available Technology Economically Achievable; CELDs = Computer-aided Environmental Legislative Database; CFR = Code of Federal Regulations; EPA = Environmental Protection Agency; FR = Federal Register; FSTRAC = Federal State Toxicology and Regulatory Alliance Committee; IARC = International Agency for Research on Cancer; NATICH = National Air Toxics Information Clearinghouse; NIOSH = National Institute for Occupational Safety and Health; ns = No Standard Has Been Developed; NNS = No Numerical Standard; OAQPS = Office of Air Quality Planning and Standards; ODW = Office of Drinking Water; OERR = Office of Emergency and Remedial Response; OSHA = Occupational Safety and Health Administration; OW = Office of Water; PEL = Permissible Exposure Limit; PICs = Product of Incomplete Combustion; PQL = Permissible Quantity Limit; RfD = Reference Dose; RQ = Reportable Quantity; SOCM I = Synthetic Organic Chemical Manufacturing Industry; STEL = Short-Term Exposure Limit; THM = Trihalomethanes; TLV = Threshold Limit Value; TSCA = Toxic Substance Control Act; TSDF = Treatment, Storage and Disposal Facility; TTO = Total Toxic Organics; TWA = Time-Weighted Average for 8-hour exposure; WHO = World Health Organization





## 8. REFERENCES

- \*Aaron CK, Howland MA, eds. 1994. Goldfrank's Toxicologic Emergencies. Norwalk, CT: Appleton and Lange.
- \*Abdel-Rahman MA. 1982. The presence of trihalomethanes in soft drinks. *J Appl Toxicol* 2:165-166.
- Abrams K, Harvell JD, Shriner D, et al. 1993. Effect of organic solvents on in vitro human skin water barrier function. *J Invest Dermatol* 101(4):609-613.
- Abuelo JG. 1990. Renal failure caused by chemicals, foods, plants, animal venoms, and misuse of drugs. *Arch Intern Med* 150:505-510.
- \*ACGIH. 1992. Threshold limit values for chemical substances and physical agents and biological exposure indices (1992- 1993). American Conference of Governmental Industrial Hygienists. Cincinnati, OH.
- \*ACGIH. 1994. Threshold limit values for chemical substances and physical agents and biological exposure indices for 1994-1995. American Conference of Governmental Industrial Hygienists. Cincinnati, OH.
- \*Ade P, Guastadisegni C, Testai E, et al. 1994. Multiple activation of chloroform in kidney microsome from male and female DBA/2J mice. *J Biochem Toxicol* 9(6):289-295.
- \*Aggazzotti G, Fantuzzi G, Righi E, et al. 1993. Chloroform in alveolar air of individuals attending indoor swimming pools. *Arch Environ Health* 48(4):250-254.
- \*Aggazzotti G, Fantuzzi G, Tartoni PL, et al. 1990. Plasma chloroform concentrations in swimmers using indoor swimming pools. *Arch Environ Health* 45(3): 175-179.
- Agrawal HC, Agrawal D. 1989. Tumor promoters accentuate phosphorylation of PO: Evidence for the presence of protein kinase C in purified PNS myelin. *Neurochem Res* 14:409-413.
- \*Ahlstrom RC, Steele JM. 1979. Chlorocarbons, hydrocarbons (CH<sub>3</sub>Cl). In: Grayson M, Eckroth D, eds. Kirk-Othmer encyclopedia of chemical technology, 3rd ed. Volume 5. New York, NY: John Wiley and Sons, 677-685.
- Ahmadizadeh M, Kuo C, Echt R, et al. 1984. Effect of polybrominated biphenyls, b-naphthoflavone and phenobarbital on arylhydrocarbon hydroxylase activities and chloroform-induced nephrotoxicity and hepatotoxicity in male C57BL/6J and DBA/2J mice. *Toxicology* 31:343-352.
- \*Ahmed AE, Kubic VL, Anders MW. 1977. Metabolism of haloforms to carbon monoxide. I. *In vitro* studies. *Drug Metab Dispos* 5:198-204.

## 8. REFERENCES

- \*Aiking H, Van Acker MB, Scholten RJPM, et al. 1994. Swimming pool chlorination: A health hazard? *Toxicol Lett* 72 (1-3):375-380.
- \*Alavanja M, Goldstein I, Susser M. 1978. A case control study of gastrointestinal and urinary tract cancer mortality and drinking water chlorination. In: Jolley RJ, Gorchen H, Hamilton DH Jr., eds. *Water Chlorination, Environmental Impact and Health Effects*. Ann Arbor, MI: Ann Arbor Science Publications, 1:395-409.
- \*Alles G, Bauer U, Selenka F. 1988. Volatile organochlorine compounds in human tissue. *Zentralbl Bakteriol Mikrobiol Hyg [B]* 186:233-246.
- \*Alles G, Bauer U, Selenka F, et al. 1988. Volatile organochlorine compounds in human tissue. *Zbl Bakt Hyg* 233-246.
- \*Amaral OC, Olivella L, Grimalt JO. 1994. Combined solvent extraction-purge and trap method for the determination of volatile organic compounds in sediments. *J Chromatogr A* 675(1):177-187.
- \*Amoore JE, Hautala AE. 1983. Odor as an aid to chemical safety: Odor thresholds compared with threshold limit values and volatilities for 214 industrial chemicals in air and water dilution. *J Appl Toxicol* 3:272-290.
- \*Andelman JB. 1985a. Human exposures to volatile halogenated organic chemicals in indoor and outdoor air. *Environ Health Perspect* 62:313-318.
- \*Andelman JB. 1985b. Inhalation exposure in the home to volatile organic contaminants of drinking water. *Sci Total Environ* 47:443-460.
- \*Andelman JB. 1990. Total exposure to volatile organic compounds in potable water. In: *Significance and Treatment of Volatile Organic Compounds in Water Supplies*. Chelsea, MI: Lewis Publishers, Inc.
- \*Anders MW, Stevens JL, Sprague RW, et al. 1978. Metabolism of haloforms to carbon monoxide. II. *In vivo* studies. *Drug Metab Dispos* 6:556-560.
- \*Andersen ME, Clewell HJ, III, Gargas ML, et al. 1987. Physiologically based pharmacokinetics and the risk assessment process for methylene chloride. *Toxicol Appl Pharmacol* 87:185-205.
- \*Andersen ME, Krishnan K. 1994. Relating *in vitro* to *in vivo* exposures with physiologically based tissue dosimetry and tissue response models. In: Salem H, ed. *Current concepts and approaches on animal test alternatives*. U.S. Army Chemical Research Development and Engineering Center, Aberdeen Proving Ground, Maryland.
- \*Anderson TA, Beauchamp JJ, Walton BT. 1991. Fate of volatile and semivolatile organic chemicals in soils: Abiotic versus biotic losses. *J Environ Qual* 20(2):420-424.
- Aniya Y, Ojiri Y, Sunagawa R, et al. 1989. Glutathione s-transferases and chloroform toxicity in streptozotocin-induced diabetic rats. *Jpn J Pharmacol* 50:263-269.

## 8. REFERENCES

- \*Antoine SR, DeLeon IR, O'Dell-Smith RM. 1986. Environmentally significant volatile organic pollutants in human blood. *Bull Environ Contam Toxicol* 36:364-371.
- \*Aranyi C, O'Shea WJ, Graham JA, et al. 1986. The effects of inhalation of organic chemical air contaminants on murine lung host defenses. *Fundam Appl Toxicol* 6:713-720.
- \*Armstrong DW, Golden T. 1986. Determination of distribution and concentration of trihalomethanes in aquatic recreational and therapeutic facilities by electron capture GC. *LC-GC* 4:652-655.
- \*Ashley DL, Bonin MA, Cardinali FL, et al. 1992. Determining volatile organic compounds in human blood from a large sample population by using purge and trap gas chromatography/mass spectrometry. *Anal Chem* 64(9):1021-1029.
- \*ASTER. 1996. ASTER (Assessment Tools for the Evaluation of Risk) ecotoxicity profile. Duluth, MN: Environmental Research Laboratory, U.S. Environmental Protection Agency.
- \*Atkinson R. 1985. Kinetics and mechanisms of the gas-phase reactions of the hydroxyl radical with organic compounds under atmospheric conditions. *Chem Rev* 85:89-91, 113.
- \*ATSDR. 1989. Decision guide for identifying substance-specific data needs related to toxicological profiles. Agency for Toxic Substances and Disease Registry, Division of Toxicology, Atlanta, GA.
- \*ATSDR. 1994. Toxicological profile for carbon tetrachloride TP-93/02. Agency for Toxic Substances and Disease Registry, Division of Toxicology, Atlanta, GA.
- \*ATSDR/CDC. 1990. Subcommittee report on biological indicators of organ damage. Agency for Toxic Substances and Disease Registry, Centers for Disease Control and Prevention, Atlanta, GA.
- Aviado DM. 1972. Chloroform. In: Krantz and Carr's pharmacologic principles of medical practice, eighth edition. Baltimore, MD: Waverly Press, Inc., 250-261.
- \*Azri-Meehan S, Mata HP, Gandolfi AJ, et al. 1992. The hepatotoxicity of chloroform in precision-cut rat liver slices. *Toxicology* 73(3):239-250.
- \*Azri-Meehan S, Mata HP, Gandolfi AJ, et al. 1994. The interactive toxicity of CHC13 and BrCC13 in precision-cut rat liver slices. *Fundam Appl Toxicol* 22(2): 172- 177.
- \*Bachmann K, Polzer J. 1989. Determination of tropospheric phosgene and other halocarbons by capillary gas chromatography. *J Chromatogr* 481:373-379.
- \*Baeder C, Hofmann T. 1988. Inhalation embryotoxicity study of chloroform in Wistar rats Frankfurt: Pharma Research Toxicology and Pathology, Hoechst Aktiengesellschaft.
- \*Bai C-L, Canfield PJ, Stacey NH. 1992. Individual serum bile acids as early indicators of carbon tetrachloride- and chloroform-induced liver injury. *Toxicol* 75(3):221-234.
- \*Bai CL, Stacey NH. 1993. Effects of carbon tetrachloride and chloroform on bile acid transport in isolated rat hepatocytes: relationship to elevated serum bile acids. *Toxic In Vitro* 7(3):197-203.

## 8. REFERENCES

- \*Baillie MB, Smith JH, Newton JF, et al. 1984. Mechanism of chloroform nephrotoxicity. IV. Phenobarbital potentiation of *in vitro* chloroform metabolism and toxicity in rabbit kidneys. *Toxicol Appl Pharmacol* 74:285-292.
- \*Balster RL, Borzelleca JF. 1982. Behavioral toxicity of trihalomethane contaminants of drinking water in mice. *Environ Health Perspect* 46: 127-136.
- \*Banerjee S, Yalkowsky SH, Valvani SC. 1980. Water solubility and octanol/water partition coefficients of organics. Limitations of the solubility-partition coefficient correlation. *Environ Sci Technol* 14:1227-1229.
- \*Barkley J, Bunch J, Bursey JT, et al. 1980. Gas chromatography mass spectrometry computer analysis of volatile halogenated hydrocarbons in man and his environment. A multimedia environmental study. *Biomed Mass Spectrom* 7: 130-147.
- \*Barnes D, Fitzgerald PA, Swan HB. 1989. Catalysed formation of chlorinated organic materials in waters. *Water Sci Technol* 21(2):59-63.
- \*Barnes DG, Dourson M. 1988. Reference dose (RfD): Description and use in health risk assessment. *Regul Toxicol Pharmacol* 8:471-486.
- \*Barrows ME, Petrocelli SR, Macek KJ, et al. 1980. Bioconcentration and elimination of selected water pollutants by bluegill sunfish (*Lepomis macrochirus*). In: Haque R, ed. Dynamics, exposure and hazard assessment of toxic chemicals. Ann Arbor, MI: Ann Arbor Science 379-392.
- \*Bauer S, Solyom D. 1994. Determination of volatile organic compounds at the parts per trillion level in complex aqueous matrices using membrane introduction mass spectrometry. *Anal Chem* 66(24):4422-4431.
- \*Bayer CW, Black MS, Galloway LM. 1988. Sampling and analysis techniques for trace volatile organic emissions from consumer products. *J Chromatogr Sci* 26(4):168-173.
- \*Bean RM, Thomas BL, Neitzel DA. 1985. Analysis of sediment matter for halogenated products from chlorination of power plant cooling water. In: Proceedings of the 5th Water Chlorination Conference. Chelsea, MI: Lewis Publishers, Inc., 1357-1370.
- \*Begerow J, Jermann E, Keles T, et al. 1995. Passive sampling for volatile organic compounds VOCs in air at environmentally relevant concentration levels. *Fresenius' Journal of Analytical Chemistry* 35 1(6):549-554.
- Belfiore F, Zimmerman HJ. 1970. Cytotoxicity of chlorinated hydrocarbons *in vitro*: Observations on chloroform-induced hemolysis. *Proc Soc Exp Biol Med* 134:61-66.
- \*Bellar TA, Lichtenberg JJ, Kroner RC. 1974. The occurrence of organohalides in chlorinated drinking water. *J Amer Water Works Assoc* 66:703-706.
- \*Benoit FM, Jackson R. 1987. Trihalomethane formation in whirlpool spas. *Water Res* 2 (13):353-357.

## 8. REFERENCES

Berardesca E, Herbst R, Maibach H. 1993. Plastic occlusion stress test as a model to investigate the effects of skin delipidization on the stratum corneum water holding capacity *in vivo*. *Dermatology* 187:91-94.

\*Berger D, Vischer TL, Micheli A. 1983. Induction of proteolytic activity in serum by treatment with amniotic detergents and organic solvents. *Experientia* 39: 1109-1111.

Berger ML, Sozeri T. 1987. Rapid halogenated hydrocarbon toxicity in isolated hepatocytes as mediated by direct solvent effects. *Toxicology* 45:319-330.

\*Bergman K. 1979. Whole-body autoradiography and allied tracer techniques in distribution and elimination studies of some organic solvents. Benzene, toluene, xylene, styrene, methylene chloride, chloroform, carbon tetrachloride and trichloroethylene. *Stand J Work Environ Health S(Supp1 1):263*.

Birnbaum LS. 1987. Age-related changes in carcinogen metabolism. *J Am Geriatr Soc* 35:51-60.

Blackshaw JK, Fenwick DC, Beattie AW, et al. 1988. The behavior of chickens, mice and rats during euthanasia with chloroform, carbon dioxide and ether. *Lab Anim* 22:67-75.

\*Blancato JN, Chiu N. 1994. Use of pharmacokinetic models to estimate internal doses from exposure. In: Wang R, ed. *Water contamination & health*. New York, NY: Marcel Dekker, Inc., 217-239.

\*Blanchard RD, Hardy JK. 1986. Continuous monitoring device for the collection of 23 volatile organic priority pollutants. *Anal Chem* 58(7):1529-1532.

Bogen KT, Colston BW Jr., Machicao LK. 1992. Dermal absorption of dilute aqueous chloroform, trichloroethylene, and tetrachloroethylene in hairless guinea pigs. *Fundam Appl Toxicol* 18:30-39.

\*Bornski H, Sobolewska A, Strakowski A. 1967. [Toxic damage of the liver by chloroform in chemical industry workers.] *Int Arch F Gewerbepathologie u. Gewerbehygiene* 24: 127- 134 (German)

Borzelleca JF, O'Hara TM, Gennings C, et al. 1990. Interactions of water contaminants. I. Plasma enzyme activity and response surface methodology following gavage administration of CC14 and CHC13 or TCE singly and in combination in the rat. *Fundam Appl Toxicol* 14:477-490.

\*Boublik T, Fried V, Hala E. 1984. The vapor pressures of pure substances: Selected values of the temperature dependence of the vapor pressures of some pure substances in the normal and low-pressure region. Volume 17. Amsterdam, Netherlands: Elsevier Scientific Publications.

\*Bouwer EJ, McCarty PL. 1983. Transformations of 1- and 2-carbon halogenated aliphatic organic compounds under methanogenic conditions. *Appl Environ Microbiol* 45(4):1286-1294.

\*Bouwer EJ, McCarty PL, Lance JC. 1981b. Trace organic behavior in soil columns during rapid infiltration of secondary wastewater. *Water Res* 15: 151-159.

\*Bouwer EJ, Rittman B, McCarty PL. 1981a. Anaerobic degradation of halogenated 1- and 2-carbon organic compounds. *Environ Sci Technol* 15:596-599.

## 8. REFERENCES

- \*Bove FJ, Fulcomer MC, Klotz JB, et al. 1995. Public drinking water contamination and birth outcomes. *American Journal of Epidemiology* 141(9):850-862.
- \*Bowman FJ, Borzelleca JF, Munson AE. 1978. The toxicity of some halomethanes in mice. *Toxicol Appl Pharmacol* 44:213-215.
- Boyland E. 1987. Estimation of acceptable levels of tumour promoters. *Br J Ind Med* 44:422-423.
- Brady JF, Li D, Ishizaki H, et al. 1989. Induction of cytochromes P450IIE1 and P450IIB1 1 by secondary ketones and the role of P450IIE1 in chloroform metabolism. *Toxicol Appl Pharmacol* 100:342-349.
- \*Branchflower RV, Nunn DS, Highet RJ, et al. 1984. Nephrotoxicity of chloroform: Metabolism to phosgene by the mouse kidney. *Toxicol Appl Pharmacol* 72: 159-168.
- Branchflower RV, Pohl LR. 1981. Investigation of the mechanism of the potentiation of chloroform-induced hepatotoxicity and nephrotoxicity by methyl n-butyl ketone. *Toxicol Appl Pharmacol* 61:407-4 13.
- \*Brass JH, Feige MA, Halloran T, et al. 1977. The National Organic Monitoring Survey: Sampling and analyses for purgeable organic compounds. In: *Drinking water quality enhancement source protection*, 393-4 16.
- Brittebo EB, Kowalski B, Brandt I. 1987. Binding of the aliphatic halides 1,2-dibromoethane and chloroform in the rodent vaginal epithelium. *Pharmacol Toxicol* 60:294-298.
- \*Brodzinsky R, Singh HB. 1982. Volatile organic chemicals in the atmosphere: An assessment of available data. Menlo Park, CA: Atmospheric Science Center, SRI International. Contract 68-02-3452.
- \*Brown BR Jr., Sipes IG, Sagalyn AM. 1974b. Mechanisms of acute hepatic toxicity: Chloroform, halothane, and glutathione. *Anesthesiology* 41:554-561.
- \*Brown DM, Langley PF, Smith D, et al. 1974a. Metabolism of chloroform. I. The metabolism of 14C-chloroform by different species. *Xenobiotica* 4: 151- 163.
- Brunius G. 1987. Mitogenic activity of chloroform and carbon tetrachloride in serum-deficient or calcium-deficient cultures of human embryonic lung fibroblasts. *Carcinogenesis* 11: 1645- 1649.
- \*Bull RJ, Brown JM, Meierhenry EA. 1986. Enhancement of the hepatotoxicity of chloroform in B6C3F1 mice by corn oil: Implications for chloroform carcinogenesis. *Environ Health Perspect* 69:49-58.
- \*Bureau International Technique des Solvants Chlores. 1976. Standardizations of methods for the determination of traces of some volatile chlorinated aliphatic hydrocarbons in air and water by gas chromatography. *Anal Chim Acta* 82: 1- 17.
- “Burkhalter JE, Balster RL. 1979. Behavioral teratology evaluation of trichloromethane in mice. *Neurobehav Toxicol* 1: 199-205.

## 8. REFERENCES

- \*Butler TC. 1961. Reduction of carbon tetrachloride *in vivo* and reduction of carbon tetrachloride and chloroform *in vitro* by tissues and tissue constituents. *J Pharmacol Exp Ther* 134:311-319.
- \*C&EN. 1994. Production by the U.S. Chemical Industry. *Chem Engin News* 72 (27):30-36.
- \*C&EN. 1995. Fact & figures for the chemical industry. *Chem Engin News* 73 (26):36-44.
- \*Caldwell KK, Harris RA. 1985. Effects of anesthetic and anticonvulsant drugs on calcium-dependent efflux of potassium from human erythrocytes. *Eur J Pharmacol* 107: 119-125.
- \*Callen DF, Wolf CR, Philpot RM. 1980. Cytochrome p-450 mediated genetic activity and cytotoxicity of seven halogenated aliphatic hydrocarbons in *Saccharomyces cerevisiae*. *Mutat Res* 77:55-63.
- \*Cammann K, Hubner K. 1995. Trihalomethane concentrations in swimmers' and bath attendants' blood and urine after swimming or working in indoor swimming pools. *Archives of Environmental Health* 50(1):61-65.
- \*Cantor KP, Hoover R, Mason TJ, et al. 1978. Associations of cancer mortality with halomethanes in drinking water. *J Natl Cancer Inst* 61:979-985.
- \*Capel ID, Dorrell HM, Jenner M, et al. 1979. The effect of chloroform ingestion on the growth of some murine tumours. *Eur J Cancer* 15:1485-1490.
- \*Cardinali FL, McGraw JM, AsheIy DL, et al. 1994. Production of blank water for the analysis of volatile organic compounds in human blood at the low part-per-trillion level. *J Chromatogr Sci* 32 (1):41-45.
- \*Carla V, Moroni F. 1992. General anaesthetics inhibit the responses induced by glutamate receptor agonists in the mouse cortex. *Neurosci Lett* 146 (1):21-24.
- \*Cech I, Smith V, Henry J. 1982. Spatial and seasonal variations in concentration of trihalomethanes in drinking water. In: Albaiges J, ed. *Analytical techniques in environmental chemistry, II*. New York, NY: Pergamon Press, 19-38.
- \*CELDs. 1994. Computer-aided Environmental Legislative Data Systems. United States Army Corps of Engineers Environmental Technical Information Systems, University of Illinois, Urbana, IL.
- \*Chai M, Arthur CL, Pawliszyn J, et al. 1993. Determination of volatile chlorinated hydrocarbons in air and water with solid-phase microextraction. *Analyst (Cambridge, U. K.)* 118 (12):1501-1505.
- \*Chai M, Pawliszyn J. 1995. Analysis of environmental air samples by solid-phase microextraction and gas chromatography/ion trap mass spectrometry. *Environ Sci Technol* 29:693-701.
- \*Challen PJR, Hickish DE, Bedford J. 1958. Chronic chloroform intoxication. *Br J Ind Med* 15:243-249.
- Cheeseman KH, Albano EF, Tomasi A, et al. 1985. Biochemical studies on the metabolic activation of halogenated alkanes. *Environ Health Perspect* 64:85-101.



## 8. REFERENCES

- \*Chenoweth MB, Robertson DN, Erley DS, et al. 1962. Blood and tissue levels of ether, chloroform, halothane and methoxyflurane in dogs. *Anesthesiology* 23:101-106.
- \*Chinery RL, Gleason AK. 1993. A compartmental model for the prediction of breath concentration and absorbed dose of chloroform after exposure while showering. *Risk Anal* 13 (1):5 1-62.
- \*Chiou WL. 1975. Quantitation of hepatic and pulmonary first-pass effect and its implications in pharmacokinetic study. I. Pharmacokinetics of chloroform in man. *J Pharmacokinet Biopharm* 3:193-201.
- \*Chu I, Secours V, Marino I, et al. 1980. The acute toxicity of four trihalomethanes in male and female rats. *Toxicol Appl Pharmacol* 52:351-353.
- \*Chu I, Villeneuve DC, Secours VE, et al. 1982a. Trihalomethanes: II. Reversibility of toxicological changes produced by chloroform, bromodichloromethane, chlorodibromomethane and bromoform in rats. *J Environ Sci Health B* 17:225-240.
- \*Chu I, Villeneuve DC, Secours VE, et al. 1982b. Toxicity of trihalomethanes: I. The acute and subacute toxicity of chloroform, bromodichloromethane, chlorodibromomethane and bromoform in rats. *J Environ Sci Health B* 17:205-224.
- \*Cianflone DJ, Hewitt WR, Villeneuve DC, et al. 1980. Role of biotransformation in the alterations of chloroform hepatotoxicity produced by kepone and mirex. *Toxicol Appl Pharmacol* 53:140-149.
- \*Clark CS, Meyer CR, Gartside PS, et al. 1982. An environmental health survey of drinking water contamination by leachate from a pesticide waste dump in Hardemena County, Tennessee. *Arch Environ Health* 37:9-18.
- \*Class T, Ballschmidter K. 1986. Chemistry of organic traces in air. VI. Distribution of chlorinated Cl-C4-hydrocarbons in air over the northern and southern Atlantic Ocean. *Chemosphere* 15(4):413-427.
- Clemens TL, Hill RN, Bullock LP, et al. 1979. Chloroform toxicity in the mouse: Role of genetic factors and steroids. *Toxicol Appl Pharmacol* 48: 117-130.
- \*Clewell HJ III, Andersen ME. 1985. Risk assessment extrapolations using physiologically-based pharmacokinetic modeling. *Toxicol Ind Health* 1: 111- 131.
- \*CLPSD. 1989. Contract Laboratory Program Statistical Database. Viar and Company, Alexandria, VA. July 12, 1989.
- \*CMR (Chemical Marketing Reporter). 1989. Chemical profile: Chloroform. New York, NY: Schnell Publishing, February 27, 1989.
- \*CMR (Chemical Marketing Reporter). 1995. Chemical profile: Chloroform. New York, NY: Schnell Publishing, February 13, 1995.
- \*Cohen EN, Hood N. 1969. Application of low-temperature autoradiography to studies of the uptake and metabolism of volatile anesthetics in the mouse. *Anesthesiology* 30:306-314.

## 8. REFERENCES

- Cohen PJ, Chance B. 1986. Is chemiluminescence an index of hepatic lipoperoxidation accompanying chloroform anesthesia? *Biochim Biophys Acta* 884:517-519.
- \*Coleman WE, Lingg RD, Melton RG, et al. 1976. The occurrence of volatile organics in five drinking water supplies using gas chromatography/mass spectrometry. In: Keith L, ed. *Analysis and identification of organic substances in water*. Ann Arbor, MI: Ann Arbor Science, 305-327.
- \*Comba ME, Palabrica VS, Kaiser KLE. 1994. Volatile halocarbons as tracers of pulp mill effluent plumes. *Environmental Toxicology and Chemistry* 13(7):1065-1074.
- \*Comporti, M. 1985. Lipid peroxidation and cellular damage in toxic liver injury. *Lab Invest* 53:599-623.
- \*Copaken J. 1990. Trihalomethanes: Is swimming pool water hazardous. In: *Water chlorination: Chemistry, Environmental Impact and Health Effects*, volume 6. Chelsea, MI: Lewis Publishers, Inc.
- \*Corley RA, Mendrala AL, Smith FA, et al. 1990. Development of a physiologically based pharmacokinetic model for chloroform. *Toxicol Appl Pharmacol* 103:5 12-527.
- \*Corsi RL, Chang DPY, Schroeder ED, et al. 1987. Emissions of volatile and potentially toxic organic compounds from municipal wastewater treatment plants. *Proceedings of the APAC Annual Meeting*, 6:1-14.
- Cowlen MS, Hewitt WR, Schroeder F. 1984. 2-Hexanone potentiation of [<sup>14</sup>C]chloroform hepatotoxicity: Covalent interaction of a reactive intermediate with rat liver phospholipid. *Toxicol Appl Pharmacol* 73:478-491.
- \*Cox RD. 1983. Analytical collection and analytical techniques for volatile organics in air. Specialty conference on: Measurement and monitoring of non-criteria contaminants in air, 101-1 12.
- \*Crebelli R, Benigni R, Franekic J, et al. 1988. Induction of chromosome malsegregation by halogenated organic solvents in *Aspergillus nidulans*: Unspecified or specified mechanism? *Mutat Res* 201:401-411.
- \*Crume RV, Ryan WM, Peters TA, et al. 1990. Risk analysis on air from groundwater aeration. *J Water Poll Control Fed* 62:119-123.
- \*Culliford D, Hewitt HB. 1957. The influence of sex hormone status on the susceptibility of mice to chloroform-induced necrosis of the renal tubules. *J Endocrinol* 14:381-393.
- \*Daft JA. 1988a. Rapid determination of fumigant and industrial chemical residues in food. *J Assoc Off Anal Chem* 71:748-760.
- \*Daft JA. 1988b. Fumigant contamination during large-scale food sampling for analysis. *Arch Environ Contam Toxicol* 17: 177- 18 1.
- \*Daft JA. 1989. Determination of fumigants and related chemicals in fatty and non-fatty foods. *J Agric Food Chem* 37:560-564.

## 8. REFERENCES

- \*Daniel FB, DeAngelo AB, Stober JA, et al. 1989. Chloroform inhibition of 1,2-dimethylhydrazine-induced gastrointestinal tract tumors in the Fisher 344 rat. *Fundam Appl Toxicol* 13:40-45.
- \*Danielsson BRG, Ghantous H, Dencker L. 1986. Distribution of chloroform and methyl chloroform and their metabolites in pregnant mice. *Biol Res Pregnancy* 7:77-83.
- Danni O, Brossa O, Burdino E, et al. 1981. Toxicity of halogenated hydrocarbons in pretreated rats - An experimental model for the study of integrated permissible limits of environmental poisons. *Int Arch Occup Environ Health* 49: 165-176.
- \*Davis ME. 1992. Dichloroacetic acid and trichloroacetic acid increase chloroform toxicity. *J Toxicol Environ Health* 37 (1): 139-148.
- \*Davis ME, Bemdt WO. 1992. Sex differences in monochloroacetate pretreatment effects on chloroform toxicity in rats. *Fundam Appl Toxicol* 18 (1):66-71.
- \*De Groot H, Noll T. 1989. Halomethane hepatotoxicity: Induction of lipid peroxidation and inactivation of cytochrome P-450 in rat liver microsomes under low oxygen partial pressures. *Toxicol Appl Pharmacol* 97:530-537.
- \*De Salva S, Volpe A, Leigh G, et al. 1975. Long-term safety studies of a chloroform-containing dentifrice and mouth-rinse in man. *Food Cosmet Toxicol* 13:529-532.
- \*De Serres FJ, Hoffmann GR, von Borstel J, et al. 1981. Summary report on the performance of yeast assays. In: *Progress in mutation research*, vol. I. Elsevier/North Holland, 67-76.
- \*Deamer DW. 1990. Anesthetic effects on membrane proton permeability. USDA/CRIS database. July 1990.
- Decker D, DiMardi SR, Calabrese EJ. 1984. Does chloroform exposure while showering pose a serious public health concern? *Med Hypotheses* 15: 119- 124.
- \*Deml E, Oesterle D. 1985. Dose-dependent promoting activity of chloroform in rat liver foci bioassay. *Cancer Lett* 29:59-63.
- “Deringer MK, Dunn TB, Heston WE. 1953. Results of exposure of strain C3H mice to chloroform. *Proc Soc Exp Biol Med* 83:474-479.
- \*Deshon HD. 1979. Carbon tetrachloride. In: Grayson M, Eckroth D, eds. *Kirk-Othmer Encyclopedia of Chemical Technology*, 3rd ed, vol 5. New York, NY: John Wiley and Sons, 693-703.
- \*Dewalle FB, Chian ESK. 1981. Detection of trace organics in well water near a solid waste landfill. *J Am Water Works Assoc* 73:206-211.
- \*Dick D, Sauder DN, Chu I. 1995. *In vitro* and *in vivo* percutaneous absorption of <sup>14</sup>C-chloroform in humans. *Human Experimental Toxicology* 14:260-265.

## 8. REFERENCES

- \*Dilling W. 1977. Interphase transfer processes. II. Evaporation rates of chloromethanes, ethanes, ethylenes, propanes, and propylenes from dilute aqueous solution. Comparisons with theoretical predictions. *Environ Sci Technol* 11:405-409.
- \*Dilling WL, Tefertiller NB, Kallos GJ. 1975. Evaporation rates of methylene chloride, chloroform, 1,1,1-trichloroethane, trichloroethylene, tetrachloroethylene, and other chlorinated compounds in dilute aqueous solutions. *Environ Sci Technol* 9 (9):833-838.
- \*Dimitriades B, Joshi SB. 1977. Application of reactivity criteria in oxidant-related emission control in the USA. In: Dimitriades B, ed. *International Conference on Photochemical Oxidant Pollution and Its Control*. Research Triangle Park, NC: U.S. Environmental Protection Agency. EPA-600/3-77-001B.
- \*Docks EL, Krishna G. 1976. The role of glutathione in chloroform-induced hepatotoxicity. *Exp Mol Pathol* 24: 13-22.
- \*Doring HJ. 1975. Reversible and irreversible forms of contractile failure caused by disturbances by general anesthetics in myocardial ATP utilization. In: Fleckenstein A, Dhalla NS, eds. *Recent Advances in Studies on Cardiac Structure and Metabolism*, vol. 5: Basic functions of cations in myocardial activity. Baltimore, MD: University Park Press, 395-403.
- \*Dreisback RH, ed. 1987. *Handbook of poisoning-1987*. Norwalk, CT: Appleton and Lange.
- \*Dreich FA, Munson TO. 1983. Purge-and-trap analysis using fused silica capillary column GCMS. *J Chromatogr Sci* 21:111-118.
- \*Dunnick JK, Melnick RL. 1993. Assessment of the carcinogenic potential of chlorinated water: experimental studies of chlorine, chloramine, and trihalomethanes. *J Natl Cancer Inst* 85(10):817-822.
- Ebel RE. 1989. Pyrazole treatment of rats potentiates CC14- but not CHC13-hepatotoxicity. *Biochem Biophys Res Commun* 161:615-618.
- \*Ebel RE. 1990. Cytochrome p-450 and halomethane activation. USDA/CRIS database. July 1990.
- \*Ebel RE, Barlow RL, McGrath EA. 1987. Chloroform hepatotoxicity in the mongolian gerbil. *Fundam Appl Toxicol* 8:207-216.
- \*Eisenreich SJ, Looney BB, Thornton JD. 1981. Airborne organic contaminants of the Great Lakes ecosystem. *Environ Sci Technol* 15(1):30-38.
- Ekstrom T, Stahl A, Sigvardsson K, et al. 1986. Lipid peroxidation *in vivo* monitored as ethane exhalation and malondialdehyde excretion in urine after oral administration of chloroform. *Acta Pharmacol Toxicol* 58:289-296.
- \*Ekstrom T, Warholm M, Kronevi T, et al. 1988. Recovery of malondialdehyde in urine as a 2,4-dinitrophenylhydrazine derivative after exposure to chloroform or hydroquinone. *Chem Biol Interact* 67:25-31.

## 8. REFERENCES

- \*El-shenawy NS, Abdel-Rahman MS. 1993a. The mechanism of chloroform toxicity in isolated rat hepatocytes. *Toxicol Lett* 69( 1):77-85.
- \*El-shenawy NS, Abdel-Rahman MS. 1993b. Evaluation of chloroform cardiotoxicity utilizing a modified isolated rat cardiac myocytes. *Toxicol Lett* 69 (3):249-256.
- \*Ellenhorn MJ, Barceloux DG, eds. 1988. *Medical toxicology: Diagnosis and treatment of human poisoning*. New York, NY: Elsevier Publishing, 972-974.
- \*Enhorning G, Potoschnik R, Possmayer F, et al. 1986. Pulmonary surfactant films affected by solvent vapors. *Anesth Analg* 65:1275-1280.
- Enosawa S, Nakazawa Y. 1986. Changes in cytochrome P450 molecular species in rat liver in chloroform intoxication. *Biochem Pharmacol* 35:1555-1560.
- \*Entz RC, Thomas KW, Diachenko GW. 1982. Residues of volatile halocarbons in foods using headspace gas chromatography. *J Agric Food Chem* 30:846-849.
- \*EPA. 1973. U.S. Environmental Protection Agency. Code of Federal Regulations. 40 CFR 136.3.
- \*EPA. 1975. U.S. Environmental Protection Agency. Code of Federal Regulations. 40 CFR 141.2.
- \*EPA. 1978. U.S. Environmental Protection Agency. Code of Federal Regulations. 40 CFR 116.4.
- \*EPA. 1979a. U.S. Environmental Protection Agency. Code of Federal Regulations. 40 CFR 141 (App. C)
- \*EPA. 1979b. U.S. Environmental Protection Agency. Code of Federal Regulations. 40 CFR 401.15.
- EPA. 1980. Ambient water quality criteria for chloroform. Office of Water Regulations and Standards, Criteria and Standards Division, U.S. Environmental Protection Agency, Washington, DC.
- \*EPA. 1981a. U.S. Environmental Protection Agency. Code of Federal Regulations. 40 CFR 403 (App. B)
- \*EPA. 1981b. U.S. Environmental Protection Agency. Code of Federal Regulations. 40 CFR 413.02.
- \*EPA. 1981b. U.S. Environmental Protection Agency. Code of Federal Regulations. 40 CFR 261 (App. VII).
- \*EPA. 1982a. Method Nos. 601 and 625. Test methods. Methods for organic chemical analysis of municipal and industrial wastewater. U.S. Environmental Protection Agency, Environmental Monitoring and Support Laboratory, Cincinnati, OH.
- \*EPA. 1982b. U.S. Environmental Protection Agency. Code of Federal Regulations. 40 CFR 423 (App. A)

## 8. REFERENCES

\*EPA. 1982c. U.S. Environmental Protection Agency. Code of Federal Regulations. 40 CFR 465.02.

EPA. 1983a. Chloroform and maleic hydrazide; Determination concluding the rebuttable presumptions against registration and notice of availability of position documents. Federal Register 48:498-501.

\*EPA. 1983b. U.S. Environmental Protection Agency. Code of Federal Regulations. 40 CFR 60.489.

\*EPA. 1983c. U.S. Environmental Protection Agency. Code of Federal Regulations. 40 CFR 122.

\*EPA. 1983d. U.S. Environmental Protection Agency. Code of Federal Regulations. 40 CFR 433.11.

\*EPA. 1985a. U.S. Environmental Protection Agency: Health assessment document for chloroform. Washington, DC: Office of Health and Environmental Assessment. EPA/600/8-84-004F. NTIS PB86-105004/XAB.

\*EPA. 1985b. U.S. Environmental Protection Agency: Survey of chloroform emission sources. Research Triangle Park, NC: Office of Air Quality. EPA/450/3-85-026.

EPA. 1985c. U.S. Environmental Protection Agency: Intent to list chloroform as a hazardous air pollutant. Federal Register 50:39626-39629.

\*EPA. 1985d. U.S. Environmental Protection Agency. Code of Federal Regulations. 40 CFR 61.01.

\*EPA. 1985e. U.S. Environmental Protection Agency. Code of Federal Regulations. 40 CFR 464.

EPA. 1985g. Health Assessment Document for Chloroform. Final Report. U.S. Environmental Protection Agency. EPA/600/8-84/004F. National Technical Information Service Publication No. PB86-105004.

\*EPA. 1986a. Method 8010. Test methods for evaluating solid waste. Volume IB: Laboratory manual physical/chemical methods. SW 846, 3rd ed. U.S. Environmental Protection Agency, Office of Solid Waste, Washington, DC.

EPA. 1986b. Evaluation of the potential carcinogenicity of chloroform. Report by Carcinogen Assessment Group, Office of Health and Environmental Assessment, Washington, DC, to Office of Emergency and Remedial Response, Office of Solid Waste and Emergency Response, U.S. Environmental Protection Agency.

EPA. 1986a. Chloroform. In: Quality criteria for water 1986. Office of Water Regulations and Standards, U.S. Environmental Protection Agency, Washington, DC.

\*EPA. 1986d. Evaluation of the potential carcinogenicity of chloroform. Report by Carcinogen Assessment Group, Office of Health and Environmental Assessment, Washington, DC, to the Office of Emergency and Remedial Response, Office of Solid Waste and Emergency Response, U.S. Environmental Protection Agency.

## 8. REFERENCES

- \*EPA. 1986e. U.S. Environmental Protection Agency. Code of Federal Regulations. 40 CFR 117.3.
- \*EPA. 1986f. U.S. Environmental Protection Agency. Code of Federal Regulations. 40 CFR 268.10.
- \*EPA. 1987a. U.S. Environmental Protection Agency: List (Phase 1) of hazardous constituents for ground-water monitoring; Final rule. 40 CFR Parts 264 and 270.
- \*EPA. 1987b. U.S. Environmental Protection Agency: Extremely hazardous substances list and threshold planning quantities; Emergency planning and release notification requirements. Federal Register 52:13378-13410.
- \*EPA. 1987c. Reportable quantity document for chloroform. Report by Environmental Criteria and Assessment Office, Office of Health and Environmental Assessment, U.S. Environmental Protection Agency, Cincinnati, OH, for the Office of Solid Waste and Emergency Response, U.S. Environmental Protection Agency.
- \*EPA. 1987d. U.S. Environmental Protection Agency. Code of Federal Regulations. 40 CFR 141.40.
- \*EPA. 1987e. U.S. Environmental Protection Agency. Code of Federal Regulations. 40 CFR 414.
- \*EPA. 1987f. U.S. Environmental Protection Agency. Code of Federal Regulations. 40 CFR 264 (App. IX).
- \*EPA. 1987g. U.S. Environmental Protection Agency. Code of Federal Regulations. 40 CFR 268 (App. III).
- \*EPA. 1987h. U.S. Environmental Protection Agency. Code of Federal Regulations. 40 CFR 355 (App. A.)
- \*EPA. 1988a. U.S. Environmental Protection Agency: Land disposal restrictions for third scheduled wastes; final rule. 40 CFR Parts 264-266, 268, and 271. Federal Register 53:31138-31145.
- \*EPA. 1988b. U.S. Environmental Protection Agency: National ambient volatile organic compounds (VOCS) Database update. EPA/600/3-88/010.
- \*EPA. 1988c. Contract Laboratory Program statement of work for organics analysis multi-media multi-component 2/88.
- EPA. 1988d. Analysis of clean water act effluent guidelines pollutants. Summary of the chemicals regulated by industrial point source category 40 CFR Parts 400-475. Draft. Prepared by Industrial Technology Division (WH 552) Office of Water Regulations and Standards. Office of Water. Washington, DC: U.S. Environmental Protection Agency.
- EPA. 1988e. Updated health effects assessment for chloroform. Report by Environmental Criteria and Assessment Office, Office of Health and Environmental Assessment, U.S. Environmental Protection Agency, Cincinnati, OH, for the Office of Solid Waste and Emergency Response, U.S. Environmental Protection Agency.

## 8. REFERENCES

\*EPA. 1988f. Method T02. Method for the determination of volatile organic compounds in ambient air by carbon molecular sieve adsorption and GC/MS. Compendium of methods for the determination of toxic organic compounds in ambient air. Atmospheric Research and Exposure Assessment Laboratory, Office of Research and Development, U.S. Environmental Protection Agency, RTP, NC. EPA/600/4-89/017.

\*EPA. 1988g. Method T03. Method for the determination of volatile organic compounds in ambient air using cryogenic preconcentration techniques and GC with flame ionization and electron capture detection. Compendium of methods for the determination of toxic organic compounds in ambient air. Atmospheric Research and Exposure Assessment Laboratory, Office of Research and Development, U.S. Environmental Protection Agency, RTP, NC. EPA/600/4-89/017.

\*EPA. 1988h. Method T01. Method for the determination of volatile organic compounds in ambient air using Tenax adsorption and GC/MS. Compendium of methods for the determination of toxic organic compounds in ambient air. Atmospheric Research and Exposure Assessment Laboratory, Office of Research and Development, U.S. Environmental Protection Agency, RTP, NC. EPA/600/4-89/O 17.

\*EPA. 1988i. Method T014. Determination of volatile organic compounds in ambient air using Summa passivated canister sampling and GC analysis. Compendium of methods for the determination of toxic organic compounds in ambient air. Atmospheric Research and Exposure Assessment Laboratory, Office of Research and Development, U.S. Environmental Protection Agency, RTP, NC. EPA/600/4-89/O 17.

\*EPA. 1988j. U.S. Environmental Protection Agency. Code of Federal Regulations. 40 CFR 261 (App. VIII).

\*EPA. 1988k. U.S. Environmental Protection Agency. Code of Federal Regulations. 40 CFR 268.43.

\*EPA. 1988l. U.S. Environmental Protection Agency. Code of Federal Regulations. 40 CFR 372.65.

\*EPA. 1988m. U.S. Environmental Protection Agency. Code of Federal Regulations. 40 CFR 716.120.

\*EPA. 1988n. Method T06. Method for the determination of phosgene in ambient air using high performance liquid chromatography. In: Compendium of methods for the determination of toxic organic compounds in ambient air. U.S. Environmental Protection Agency, Quality Assurance Division, Environmental Monitoring Systems Laboratory, ORD, Research Triangle Park, NC. (authors: WT Winberry, NT Murphy, RM Riggan). EPA-600/4-84-041. [Also... EPA-600/4-87-006 AND EPA-600/4-89-0171

\*EPA. 1989a. Interim methods for development of inhalation reference doses. U.S. Environmental Protection Agency, Office of Health and Environmental Assessment. Washington, DC. EPA 600/8-88-066F.



## 8. REFERENCES

- \*EPA. 1989b. U.S. Environmental Protection Agency: Land disposal restrictions for third scheduled wastes; proposed rule. 40 CFR Parts 148, 261, 264, 265,268, and 271. Federal Register 54:48377-48380, 48395-48396.
- \*EPA. 1989c. U.S. Environmental Protection Agency: Reportable quantity adjustments: Delisting of ammonium thiosulfate. Code of Federal Regulations 54 CFR 155.
- \*EPA. 1989d. U.S. Environmental Protection Agency. Code of Federal Regulations. 40 CFR 302.4.
- \*EPA. 1990a. Removal and fate of RCRA and CERCLA toxic organic pollutants in wastewater treatment. Cincinnati, OH: Risk Reduction Engineering Laboratory, U.S. Environmental Protection Agency. EPN600/S2-891026.
- \*EPA. 1990b. Interim methods for development of inhalation reference doses. U.S. Environmental Protection Agency. EPA-600/8-90/066A.
- \*EPA. 1990a. Methods for the determination of organic compounds, Supplement I, 169, 200.
- \*EPA. 1990d. U.S. Environmental Protection Agency. Code of Federal Regulations. 40 CFR 261.
- \*EPA. 1990e. U.S. Environmental Protection Agency. Code of Federal Regulations. 40 CFR 60.667.
- \*EPA. 1990f. U. S. Environmental Protection Agency. Code of Federal Regulations. 40 CFR 261.24
- \*EPA. 1990g. Method 55 1. Methods for the determination of organic compounds in drinking water, Supp. I. Environmental Monitoring Systems Laboratory, Office of Research and Development, U.S. Environmental Protection Agency, Cincinnati, OH. EPA-600/4-90/020.
- \*EPA. 1991a. Method 502.1. Methods for the determination of organic compounds in drinking water. U.S. Environmental Protection Agency, Cincinnati, OH. EPA-600/4-88/039.
- \*EPA. 1991b. Method 502.2. Methods for the determination of organic compounds in drinking water. U.S. Environmental Protection Agency, Cincinnati, OH. EPA-600/4-88/039.
- \*EPA. 1991c. Method 524.1. Methods for the determination of organic compounds in drinking water. U.S. Environmental Protection Agency, Cincinnati, OH. EPA-600/4-88/039.
- \*EPA. 1991d. U.S. Environmental Protection Agency. Code of Federal Regulations. 40 CFR 266.
- \*EPA. 1991e. U.S. Environmental Protection Agency. Code of Federal Regulations. 40 CFR 141.12.
- \*EPA. 1991f. U.S. Environmental Protection Agency. Code of Federal Regulations. 40 CFR 258.
- \*EPA. 1991g. U.S. Environmental Protection Agency. Code of Federal Regulations. 40 CFR 258 (APP. II).

## 8. REFERENCES

- \*EPA. 1992. Method 524.2. Measurement of purgeable organic compounds in water by capillary column GC/MS. Methods for the determination of organic compounds in drinking water, Supp. II. Environmental Monitoring Systems Laboratory, Office of Research and Development, U.S. Environmental Protection Agency, Cincinnati, OH. EPA-600/R-92/129.
- \*EPA. 1993a. U.S. Environmental Protection Agency. Federal Register. 58 FR 62566. Code of Federal Regulations. 40 CFR 63.460.
- \*EPA. 1993b. U.S. Environmental Protection Agency. Federal Register. 58 FR 20802. Code of Federal Regulations. 40 CFR 132.6.
- \*EPA. 1993c. U.S. Environmental Protection Agency. Federal Register. 58 FR 65622. Code of Federal Regulations. 40 CFR 141.30.
- \*EPA. 1993d. U.S. Environmental Protection Agency. Federal Register. 58 FR 66078. Code of Federal Regulations. 40 CFR 430.
- \*EPA. 1993e. U.S. Environmental Protection Agency. Federal Register. 58 FR 48092. Code of Federal Regulations. 40 CFR 268.40, 40 CFR 268.48.
- \*EPA. 1993f. U.S. Environmental Protection Agency. Federal Register. 58 FR 54836. Code of Federal Regulations. 40 CFR 302.4.
- \*EPA. 1994a. U.S. Environmental Protection Agency. Federal Register. 59 FR 15504. Code of Federal Regulations. 40 CFR 63.48.
- \*EPA. 1994b. U.S. Environmental Protection Agency. Federal Register. 59 FR 38668. Code of Federal Regulations. 40 CFR 141.
- \*EPA. 1994c. U.S. Environmental Protection Agency. Federal Register. 59 FR 12567. Code of Federal Regulations. 40 CFR 430.02.
- \*EPA. 1994d. U.S. Environmental Protection Agency. Federal Register. 59 FR 9808. Code of Federal Regulations. 40 CFR 261 (App. VII).
- \*EPA. 1994e. Drinking water regulations and health advisories. U.S. Environmental Protection Agency, Office of Water. Washington, D.C. 1994.
- \*EPA/AMWA. 1989. US. Environmental Protection Agency/ Association of Metropolitan Water Agencies. Disinfection by-products in United States drinking waters. Vol. 1: Report. Metropolitan Water District of Southern California, Los Angeles, CA, November 1989. Table 5-2, Figures 5-4 and 5-22.
- \*Eschenbrenner AB, Miller E. 1945a. Induction of hepatomas in mice by repeated oral administration of chloroform, with observations on sex differences. *J Natl Cancer Inst* 5:251-255.
- \*Eschenbrenner AB, Miller E. 1945b. Sex differences in kidney morphology and chloroform necrosis. *Science* 102:302-303.

## 8. REFERENCES

- \*Ewing, BB, Chian ESK, Cook JC, et al. 1977. Monitoring to detect previously unrecognized pollutants in surface waters. Appendix: Organic analysis data. U.S. Environmental Protection Agency, Washington, DC. EPA/560/6-77-015. [Appendix: EPA/560/6-77-015A].
- \*EXAMS. 1988. Exposure analysis modeling system: Reference manual for EXAMS II. U.S. Environmental Protection Agency, Environmental Research Laboratory, Athens, GA. EPA/600/3-85/038.
- \*Fagan DG, Forrest JB, Enhorning G, et al. 1977. Acute pulmonary toxicity of a commercial fluorocarbon-lipid aerosol. *Histopathology* 1:209-223.
- \*Farber JL. 1982. Calcium and the mechanism of liver necrosis. In: Popper H, Schaffner F, eds. *Progress in liver diseases*, vol 7. New York, NY: Grune & Stratton, 347-360.
- \*FDA. 1977. Indirect food additives: Adhesives and components of coatings. Code of Federal Regulations. 21 CFR 175.105.
- FDA. 1988. Indirect food additives: Adhesives and components of coatings. Code of Federal Regulations. 21 CFR 175.105-175.125.
- \*FDA. 1992. Action levels for poisonous or deleterious substances in human food and animal feed. Food and Drug Administration, Washington, D.C.
- \*Featherstone HW. 1947. Chloroform. *Anesthesiology* 8:362-371.
- \*FEDRIP. 1994. Federal Research in Progress. October 1994.
- \*FEDRIP. 1996. Federal Research in Progress. May 1996.
- \*Feingold A, Holaday DA. 1977. The pharmacokinetics of metabolism of inhalation anaesthetics: A simulation study. *Br J Anaesth* 49:155-162.
- \*Ferrario JB, Lawler GC, DeLeon IR, et al. 1985. Volatile organic pollutants in biota and sediments of Lake Pontchartrain. *Bull Contam Toxicol* 34(2):246-255.
- Fiorucci L, Monti A, Testai E, et al. 1988. *In vitro* effects of polyhalogenated hydrocarbons on liver mitochondria respiration and microsomal cytochrome p-450. *Drug Chem Toxicol* 11:387-403.
- Fonlupt P, Rey C, Pacheco H. 1987. Comparison of basal and noradrenaline stimulated methylation of chloroform-extractable products in synaptosomal preparations from the rat brain. *Biochem Pharmacol* 36:1527-1729.
- \*Fry BJ, Taylor R, Hathaway DE. 1972. Pulmonary elimination of chloroform and its metabolite in man. *Arch Int Pharmacodyn* 196:98-111.
- \*FSTRAC. 1988. Summary of state and federal drinking water standards and guidelines. U.S. Environmental Protection Agency, Chemical Communication Subcommittee, Federal-State Toxicology and Regulatory Alliance Committee (FSTRAC).

## 8. REFERENCES

- \*FSTRAC. 1990. Summary of state and federal drinking water standards and guidelines. U.S. Environmental Protection Agency, Chemical Communication Subcommittee, Federal State Toxicology and Regulatory Alliance Committee (FSTRAC).
- \*Fujii T. 1977. Direct aqueous injection gas chromatography-mass spectrometry for analysis of organohalides in water at concentrations below the parts per billion level. *J Chromatogr* 139:297-302.
- \*Furlong EAN, D'Itri FM. 1986. Trihalomethane levels in chlorinated Michigan drinking water. *Ecological Modelling* 32:215-225.
- \*Gearhart JM, Seckel C, Vinegar A. 1993. *In vivo* metabolism of chloroform in B6C3F1 mice determined by the method of gas uptake: the effects of body temperature on tissue partition coefficients and metabolism. *Toxicol Appl Pharmacol* 119(2):258-66.
- \*Gehring PJ. 1968. Hepatotoxic potency of various chlorinated hydrocarbon vapours relative to their narcotic and lethal potencies in mice. *Toxicol Appl Pharmacol* 13:287-298.
- Gettler AO. 1934. Medicolegal aspects of deaths associated with chloroform or ether. *Am J Surg* 1:168-172.
- \*Gettler AO, Blume H. 1931. Chloroform in the brain, lungs, and liver. Quantitative recovery and determination. *Arch Pathol* 11554-560.
- \*Glende EA. 1994. Toxic liver injury--Ca<sup>2+</sup>, PLA<sub>2</sub>, proteases and eicosanoids. Crisp Database, National Institutes of Health.
- \*Gobel R, Krska R, Neal S, et al. 1994. Performance studies of an ir fiber optic sensor for chlorinated hydrocarbons in water. *Fresenius' Journal of Analytical Chemistry* 350(7-9):514-519.
- \*Gocke E, King MT, Eckhardt K, et al. 1981. Mutagenicity of cosmetics ingredients licensed by the European Communities. *Mutat Res* 90:91-109.
- \*Gomez MID, Castro JA. 1980. Nuclear activation of carbon tetrachloride and chloroform. *Res Commun Chem Pathol Pharmacol* 27: 191- 194.
- \*Goodman LS, Gilman A. 1980. *The pharmacological basis of therapeutics*. 6th ed. New York, NY: MacMillan Publishing.
- \*Gopinath C, Ford EJH. 1975. The role of microsomal hydroxylases in the modification of chloroform and carbon tetrachloride. *Toxicol Appl Pharmacol* 63:281-291.
- \*Gordon SM, Wallace LA, Pellizzari ED, et al. 1988. Human breath measurements in a clean-air chamber to determine half-lives for volatile organic compounds. *Atmos Environ* 22:2165-2170.
- \*Gossett JM. 1987. Measurement of Henry's Law constant for Cl and C2 chlorinated hydrocarbons. *Environ Sci Technol* 21:202-206.
- \*Graham RC, Robertson JK. 1988. Analysis of trihalomethanes in soft drinks: An instrumental analysis experiment. *J Chem Educ* 65(8):735-737.

## 8. REFERENCES

Grass0 P, Sharratt M, Davies DM, et al. 1984. Neurophysiological and psychological disorders and occupational exposure to organic solvents. *Food Chem Toxicol* 22:819-852.

\*Greenberg AE, Clesceri LS, Eaton AD. 1992. Method 6210 B. Purge and trap packed-column gas chromatographic/mass spectrometric method I. Standard methods for the examination of water and wastewater, 18th ed.

Groger WKL, Grey TF. 1979. Effect of chloroform on the activities of liver enzymes in rats. *Toxicology* 14:23-38.

\*Gulati DK, Hope E, Mounce RC, et al. 1988. Chloroform: Reproduction and fertility assessment in CD-1 mice when administered by gavage. Report by Environmental Health Research and Testing, Inc., Lexington, KY to National Toxicology Program, National Institute of Environmental Health Sciences, Research Triangle Park, NC.

\*Haddad LM, Winchester JF, eds. 1990. Clinical management of poisoning and drug overdose. 2nd edition. Philadelphia, PA: WB Saunders.

“Hajimiragha H, Ewers U, Jansen-Rosseck R, et al. 1986. Human exposure to volatile halogenated hydrocarbons from the general environment. *Int Arch Occup Environ Health* 58:141-150.

\*Hakim A, Jain AK, Jain R. 1992. Chloroform ingestion causing toxic hepatitis. *J Assoc Physicians India* 40(7):477.

“Hampson RF. 1980. Chemical kinetic and photochemical data sheets for atmospheric reactions. Washington, DC: U.S. Department of Transportation.

\*Hansch C, Leo AJ. 1985. Medchem Project Issue 26. Claremont, CA: Pomona College.

\*Harris RA, Groh GI. 1985. Membrane disordering effects of anesthetics are enhanced by gangliosides. *Anesthesiology* 62: 115-119.

\*Harris RH, Highland JH, Rocricks JV, et al. 1984. Adverse health effects at a Tennessee hazardous waste disposal site. *Hazardous Waste* 1: 183-204.

\*Harris RN, Ratnayake JH, Garry VF, et al. 1982. Interactive hepatotoxicity of chloroform and carbon tetrachloride. *Toxicol Appl Pharmacol* 63:281-291.

\*Hawley GG, ed. 1981. The condensed chemical dictionary. 10th ed. New York, NY: Van Nostrand Reinhold, 237.

\*Haydon DA, Requena J, Simon AJB. 1988. The potassium conductance of the resting squid axon and its blockage by clinical concentrations of general anaesthetics. *J Physiol* 402:363-374.

Haydon DA, Simon AJB. 1988. Excitation of the squid giant axon by general anaesthetics. *J Physiol* 402:375-389.

\*HazDat. 1994. Agency for Toxic Substances and Disease Registry (ATSDR), Atlanta, GA. October 30,

## 8. REFERENCES

- \*HazDat. 1996. Agency for Toxic Substances and Disease Registry (ATSDR), Atlanta, GA. May 15, 1996.
- \*Heikes DL. 1987. Purge and trap method for determination of volatile hydrocarbons and carbon disulfide in table-ready foods. *J Assoc Off Anal Chem* 70:215-277.
- \*Heikes DL, Hopper ML. 1986. Purge and trap method for determination of fumigants in whole grains, milled grain products, and in intermediate grain-based foods. *J Assoc Off Anal Chem* 69:990-998.
- \*Heilbrunn G, Liebert E, Szanto PB. 1945. Chronic chloroform poisoning: Clinical and pathologic report of a case. *Arch Neurol Psych* 53:68-72.
- \*Heindel JJ, Chapin RE, George J, et al. 1995. Assessment of the reproductive toxicity of a complex mixture of 25 groundwater contaminants in mice and rats. *Fund Appl Toxicol* 25:9-19
- \*Helz GR, Hsu RY. 1978. Volatile chloro- and bromocarbons in coastal waters. *Limnol Oceanogr* 23:858-869.
- \*Henson JM, Yates, MV, Cochran JW, et al. 1988. Microbial removal of halogenated methanes, ethanes, and ethylenes in an aerobic soil exposed to methane. *Fed Eur Microbiol Soc Microbiol Ecol* 53:193-201.
- Herren-Freund SL, Pereira MA. 1986. Carcinogenicity of by-products of disinfection in mouse and rat liver. *Environ Health Perspect* 69:59-65.
- \*Herren-Freund SL, Pereira MA. 1987. The carcinogenicity of organic chemicals found in drinking water. *Proceedings Water Quality Technology Conference, Volume Date 1986, 14 (Advances in Water Analysis and Treatment):485-500.*
- \*Hewitt LA, Palmason C, Masson S, et al. 1990. Evidence for the involvement of organelles in the mechanism of ketone-potentiated chloroform-induced hepatotoxicity. *Liver* 10:35-48.
- \*Hewitt WR, Brown EM. 1984. Nephrotoxic interactions between ketonic solvents and halogenated aliphatic chemicals. *Fundam Appl Toxicol* 4:902-908.
- Hewitt WR, Brown EM, Plaa GL. 1983. Relationship between the carbon skeleton length of ketonic solvents and potentiation of chloroform-induced hepatotoxicity in rats. *Toxicol Lett* 16:297-304.
- \*Hewitt WR, Miyajima H, Cote MG, et al. 1979. Acute alteration of chloroform-induced hepato- and nephrotoxicity by mirex and kepone. *Toxicol Appl Pharmacol* 48:509-527.
- Hewitt WR, Miyajima H, Cote MG, et al. 1980. Acute alteration of chloroform-induced hepato- and nephrotoxicity by n-hexane, methyl n-butyl ketone, and 2,5-hexanedione. *Toxicol Appl Pharmacol* 53:230-248.
- \*Heywood R, Sortwell RJ, Noel PRB, et al. 1979. Safety evaluation of toothpaste containing chloroform. III. Long-term study in beagle dogs. *J Environ Pathol Toxicol* 2:835-851.

## 8. REFERENCES

- Hiasa Y, Ito N. 1987. Experimental induction of renal tumors. *CRC Crit Rev Toxicol* 17:279-343.
- \*Hickey RF, Vanderwielen J, Switzenbaum MS. 1987. Effects of organic toxicants on methane production and hydrogen gas levels during the anaerobic digestion of waste activated sludge. *Water Res* 21(11):1417-1427.
- Hill RN. 1977. Differential toxicity of chloroform in the mouse. *Ann NY Acad Sci* 298: 170-176.
- Hill RN, Clemens TL, Liu DK, et al. 1975. Genetic control of chloroform toxicity in mice. *Science* 190:159-161.
- \*Hjelle J. 1990. Halogenated hydrocarbon toxicity in proximal tubules (human, rabbits). *Crisp Data Base National Institutes of Health*.
- \*Ho JSY. 1989. A sequential analysis for volatile organics in water by purge-and-trap capillary column gas chromatography with photoionization and electrical conductivity detectors in series. *J Chromatogr Sci* 27:91-98.
- \*Hoigne J, Bader H. 1988. The formation of trichloronitromethane (chloropicrin) and chloroform in a combined ozonation/chlorination treatment of drinking water. *Water Res* 22:313-319.
- \*Hollod GJ, Wilde EW. 1982. Trihalomethanes in chlorinated cooling water of nuclear reactors. *Bull Environ Contam Toxicol* 28:404-408.
- Holm L, Holmberg G. 1987. Exposures to carcinogens and consequences of listing of carcinogens in the Swedish working environment. *Reg Toxicol Pharmacol* 7:185-199.
- \*Hook JB, Smith JH. 1985. Biochemical mechanisms of nephrotoxicity. *Transplant Proc* 17:41-50.
- \*HSDB. 1994. Hazardous Substances Data Bank. National Library of Medicine, National Toxicology Information Program, Bethesda, MD. May 1994.
- \*HSDB. 1996. Hazardous Substances Data Bank. National Library of Medicine, National Toxicology Information Program, Bethesda, MD. October 1996.
- \*Hubrich C, Stuhl F. 1980. The ultraviolet absorption of some halogenated methanes and ethanes of atmospheric interest. *J Photochem* 12:93-107.
- \*IARC. 1979. IARC monographs on the evaluation of carcinogenic risk of chemicals to humans. Vol. 20: Some halogenated hydrocarbons. Lyon, France: World Health Organization, 401-427.
- \*IARC. 1987. IARC Monographs on the evaluation of carcinogenic risks to humans. Overall evaluations of carcinogenicity: An updating of IARC monographs, Volumes 1 to 42. Lyon, France: World Health Organization, IARC Suppl 7, 60.
- \*Ijsselmuiden CB, Gaydos C, Feighner B, et al. 1992. Cancer of the pancreas and drinking water: A population based case control study in Washington County, Maryland. *American Journal of Epidemiology* 136(7):836-842.

## 8. REFERENCES

- \*Ikatsu H, Nakajima T. 1992. Hepatotoxic interaction between carbon tetrachloride and chloroform in ethanol treated rats. *Arch Toxicol* 66(8):580-586.
- \*Ilett KF, Reid WD, Sipes IG, et al. 1973. Chloroform toxicity in mice: Correlation of renal and hepatic necrosis with covalent binding of metabolites to tissue macromolecules. *Exp Mol Pathol* 19:215-229.
- \*IRIS. 1995. Integrated Risk Information System. U.S. Environmental Protection Agency, Environmental Criteria and Assessment Office, Cincinnati, OH.
- \*Islam MS, Zhao L, McDougal JN, et al. 1995. Uptake of chloroform by skin during short exposures to contaminated water. *Risk Analysis* 15(3):343-352.
- \*Jakobson I, Wahlberg JE, Holmberg B, et al. 1982. Uptake via the blood and elimination of 10 organic solvents following epicutaneous exposure of anesthetized guinea pigs. *Toxicol Appl Pharmacol* 63:181-187.
- \*Jeffers PM, Ward LM, Woytowitch LM, et al. 1989. Homogenous hydrolysis rate constants for selected chlorinated methanes, ethanes, ethenes, and propanes. *Environ Sci Technol* 23:967-969.
- Jernigan JD, Harbison RD. 1982. Role of biotransformation in the potentiation of halocarbon hepatotoxicity by 2,5-hexanedione. *J Toxicol Environ Health* 9:761-781.
- \*Jo WK, Weisel CP, Liroy PJ. 1990. Routes of chloroform exposure and body burden from showering with chlorinated tap water. *Risk Anal* 10(4):575-580.
- John JA, Wroblewski DJ, Schwetz BA. 1984. Teratogenicity of experimental and occupational exposure to industrial chemicals. *Issues and Reviews in Teratology* 8:267-324.
- \*Jones WM, Margolis G, Stephen CR. 1958. Hepatotoxicity of inhalation anesthetic drugs. *Anesthesiology* 19:715-723.
- \*Jorgenson TA, Meierhenry EF, Rushbrook CJ, et al. 1985. Carcinogenicity of chloroform in drinking water to male Osborne-Mendel rats and female B6C3F<sub>1</sub> mice. *Fundam Appl Toxicol* 5:760-769.
- \*Jorgenson TA, Rushbrook CJ. 1980. Effects of chloroform in the drinking water of rats and mice: Ninety-day subacute toxicity study. Report by SRI International, Menlo Park, CA to Health Effects Research Laboratory, Office of Research and Development, U.S. Environmental Protection Agency, Cincinnati, OH.
- \*Kanada M, Miyagawa M, Sato M, et al. 1994. Neurochemical profile of effects of 28 neurotoxic chemicals on the central nervous system in rats (1) effects of oral administration on brain contents of biogenic amines and metabolites. *Ind Health* 32: 145-164.
- \*Kasso WV, Wells MR. 1981. A survey of trihalomethanes in the drinking water system of Murfreesboro, Tennessee, USA. *Bull Environ Contam Toxicol* 27:295-302.



## 8. REFERENCES

- \*Kawamura K, Kaplan IR. 1983. Organic compounds in the rainwater of Los Angeles. *Environ Sci Technol* 17:497-501.
- \*Kelly TJ, Mukund R, Spicer CW, et al. 1994. Concentrations and transformations of hazardous air pollutants. *Environ Sci Technol* 28(8):378-387.
- Kerfoot HB. 1987. Soil-gas measurement for detection of ground water contamination by volatile organic compounds. *Environ Sci Technol* 21:1022-1024.
- \*Kimura ET, Ebert DM, Dodge PW. 1971. Acute toxicity and limits of solvent residue for sixteen organic solvents. *Toxicol Appl Pharmacol* 19:699-704.
- \*King RB. 1993. Topical aspirin in chloroform and the relief of pain due to herpes zoster and postherpetic neuralgia. *Arch Neural* 50:1046-1053.
- \*Kirkland DJ, Smith KL, Van Abbe NJ. 1981. Failure of chloroform to induce chromosome damage or sister-chromatid exchanges in cultured human lymphocytes and failure to induce reversion in *Escherichia coli*. *Food Cosmet Toxicol* 19:651-656.
- Kitchin KT, Brown JL. 1989. Biochemical effects of three carcinogenic chlorinated methanes in rat liver. *Teratogen Carcinogen Mutagen* 9:61-69.
- \*Klaassen CD, Plaa GL. 1966. Relative effects of various chlorinated hydrocarbons on liver and kidney function in mice. *Toxicol Appl Pharmacol* 9: 139- 151.
- \*Klaassen CD, Plaa GL. 1967. Relative effects of various chlorinated hydrocarbons on liver and kidney function in dogs. *Toxicol Appl Pharmacol* 10: 119-131.
- Klaunig JE, Ruth RJ. 1990. Biology of disease: Role of inhibition of intercellular communication in carcinogenesis. *Lab Invest* 62:135-146.
- \*Klaunig JE, Ruth RJ, Pereira MA. 1986. Carcinogenicity of chlorinated methane and ethane compounds administered in drinking water to mice. *Environ Health Perspect* 69: 89-95.
- \*Kluwe WM, Hook JB. 1981. Potentiation of acute chloroform nephrotoxicity by the glutathione depletor diethyl maleate and protection by the microsomal enzyme inhibitor piperonyl butoxide. *Toxicol Appl Pharmacol* 59:457-466.
- Kniepert E, Gorisch V. 1988. Influence of alcohol pretreatment on effects of chloroform in rats. *Biomed Biochim Acta* 47:197-203.
- \*Kramer MD, Lynch CF, Isacson P, et al. 1992. The association of waterborne chloroform with intrauterine growth retardation. *Epidemiology* 3(5):407-413.
- \*Krasner SW, McGuire MJ, Jacangelo JG, et al. 1989. The occurrence of disinfection by-products in U.S. drinking water. *J Am Water Works Assoc* 81:41-53.
- \*Krishnan K, Andersen M. 1994. Physiologically-based pharmacokinetic modeling in toxicology. In: Hayes W, ed. *Principles and methods of toxicology*, 3rd edition. New York, NY: Raven Press, Ltd.

## 8. REFERENCES

- \*Krishnan K, Andersen M, Clewell HJ III, et al. 1994. Physiologically-based pharmacokinetic modeling of chemical mixtures. In: Yang RSA, ed. Toxicology of chemical mixtures. New York, NY: Academic Press.
- \*Kroll RB, Robinson GD, Chung JH. 1994a. Characterization of trihalomethane (THM)-induced renal dysfunction in the rat. II: Relative potency of THMs in promoting renal dysfunction, Arch Environ Contam Toxicol 27( 1):5-7.
- \*Kroll RB, Robinson GD, Chung JH. 1994b. Characterization of trihalomethane (THM)-induced renal dysfunction in the rat. I: Effects of THM on glomerular filtration and renal concentrating ability. Arch Environ Contam Toxicol 27( 1): 1-4.
- \*Kroneld R. 1986. Chloroform in tap water and human blood. Bull Environ Contam Toxicol 36:477-483.
- Kroneld R. 1989. Volatile pollutants in the environment and human tissues. Bull Environ Contam Toxicol 42:873-877.
- \*Krotoszynski B, Bruneau GM, O'Neill HJ. 1979. Measurement of chemical inhalation exposure in urban population in the presence of endogenous effluents. J Anal Toxicol 3:225-234.
- Krus S, Zaleska-Rutczynska Z. 1969. Morphological counterparts of the genetically determined resistance of mice to chloroform poisoning. Experientia 26: 101-102.
- Kunke KS, Strunk RC. 1981. Complement synthesis by guinea pig peritoneal macrophages: Failure to detect chemical carcinogens. J Natl Cancer Inst 66:141-146.
- \*Kutob SD, Plaa GL. 1962. The effect of acute ethanol intoxication on chloroform-induced liver damage. J Pharmacol Exp Ther 135:245-251.
- \*Kylin B, Reichard H, Sumegi I, et al. 1963. Hepatotoxicity of inhaled trichloroethylene, tetrachloroethylene and chloroform. Single exposure. Acta Pharmacol Toxicol 20: 16-26.
- \*Land PC, Owen EL, Linde HW. 1979. Mouse sperm morphology following exposure to anesthetics during early spermatogenesis. Anesthesiology 51:259.
- \*Land PC, Owen EL, Linde, HW. 1981. Morphologic changes in mouse spermatozoa after exposure to inhalation anesthetics during early spermatogenesis. Anesthesiology 54:53-56.
- \*Landauer MR, Lynch MR, Balster RL, et al. 1982. Trichloromethane-induced taste aversions in mice. Neurobehav Toxicol Teratol 4:305-309.
- Landon EJ, Naukam RJ, Sastry BVR. 1986. Effects of calcium channel blocking agents on calcium and centrilobular necrosis in the liver of rats treated with hepatotoxic agents. Biochem Pharmacol 35:697-705.
- \*LaRegina J, Bozzelli JW, Harkov R, et al. 1986. Volatility organic compounds at hazardous waste sites and a sanitary landfill in New Jersey. An up-to-date review of the present situation. Environ Prog 5: 18-27.

## 8. REFERENCES

- \*Larson JL, Sprankle CS, Butterworth BE. 1994a. Lack of chloroform-induced DNA repair *in vitro* and *in vivo* in hepatocytes of female B6C3F<sub>1</sub> mice. *Environ Mol Mutagen* 23(2):132-136.
- \*Larson JL, Templin MV, Wolf DC. 1996. A 90-day chloroform inhalation study in female and male B6C3F<sub>1</sub> mice: Implications for cancer risk assessment. *Fundamental and Applied Toxicology* 30:118-137.
- \*Larson JL, Wolf DC, Butterworth BE. 1993. Acute hepatotoxic and nephrotoxic effects of chloroform in male F-344 rats and female B6C3F<sub>1</sub> mice. *Fundam Appl Toxicol* 20(3):302-315.
- \*Larson JL, Wolf DC, Butterworth BE. 1994b. Induced cytotoxicity and cell proliferation in the hepatocarcinogenicity of chloroform in female B6C3F<sub>1</sub> mice: comparison of administration by gavage in corn oil vs ad libitum in drinking water. *Fund Appl Toxicol* 22:90-102.
- \*Larson JL, Wolf DC, Butterworth BE. 1995a. Induced regenerative cell proliferation in livers and kidneys of male F-344 rats given chloroform in corn oil by gavage or ad libitum in drinking water. *Toxicology* 95:73-86.
- \*Larson JL, Wolf DC, Mery S, et al. 1975b. Toxicity and cell proliferation in the liver, kidneys and nasal passages of female F-344 rats, induced by chloroform administered by gavage. *Fd Chem Toxic* 33(6):443-456.
- \*Larson JL, Wolf DC, Mery S, et al. 1995b. Toxicity and cell proliferation in the liver kidneys and nasal passages of female F-344 rats, induced by chloroform administered by gavage. *Fd Chem Toxic* 33(6):443-456.
- \*Larson JL, Wolf DC, Morgan KT, et al. 1994c. The toxicity of 1-week exposures to inhaled chloroform in female B6C3F<sub>1</sub> mice and male F-344 rats. *Fund Appl Toxicol* 22:431-446.
- Laurie RD, Bercz JP, Wessendarp TK, et al. 1986. Studies of the toxic interactions of disinfection by-products. *Environ Health Perspect* 69:203-207.
- \*Lavigne JG, Marchand C. 1974. The role of metabolism in chloroform hepatotoxicity. *Toxicol Appl Pharmacol* 29:312-326.
- \*Lehmann KB, Flury FF. 1943. Chlorinated hydrocarbons. In: Lehman KB, Flury FF, eds. *Toxicology and Hygiene of Industrial Solvents*. Baltimore, MD: Williams and Wilkins, 138-145 and 191-196.
- \*Lehmann KB, Hasegawa. 1910. [Studies of the absorption of chlorinated hydrocarbons in animals and humans,] *Arch Hyg* 72:327. (German)
- \*Letteron P, Degott C, Labbe G, et al. 1987. Methoxsalen decreases the metabolic activation and prevents the hepatotoxicity and nephrotoxicity of chloroform in mice. *Toxicol Appl Pharmacol* 91:266-273.
- \*Leung H. 1993. Physiologically-based pharmacokinetic modeling. *General and applied toxicology*. Vol. I. Ballantine B, Marro T, Turner T, eds. New York, NY: Stockton Press, 153-164.

## 8. REFERENCES

- \*Levesque B, Ayotte P, LeBlanc A, et al. 1994. Evaluation of dermal and respiratory chloroform exposure in humans. *Environ Health Perspect* 102( 12): 1082- 1087.
- \*Li G Hanai Y, Miyata M, et al. 1994. [Aggravating effects of chloroform and P-dichlorobenzene on experimental allergic conjunctivitis.] *Folia Ophthalmol Jpn* 45(5):475-480. (Japanese)
- \*Li LH, Jiang XZ, Liang YX, et al. 1993. Studies on the toxicity and maximum allowable concentration of chloroform. *Biomed Environ Sci* 6(2): 179- 186.
- \*Liang JC, Hsu TC, Henry JE. 1983. Cytogenetic assays for mitotic poisons. The grasshopper embryo system for volatile liquids. *Mutat Res* 113:467-479.
- \*Lipsky MM, Skinner M, O'Connell C. 1993. Effects of chloroform and bromodichloromethane on DNA synthesis in male F344 rat kidney. *Environ Health Perspect* 101 (Suppl 5):249-252.
- Lofberg B, Tjalve H. 1986. Tracing tissues with chloroform-metabolizing capacity in rats. *Toxicology* 39: 13-35.
- \*Long JL, Stensel HD, Ferguson JF, et al. 1993. Anaerobic and aerobic treatment of chlorinated aliphatic compounds. *J Environ Engin* 119(2):300-320.
- \*Lopez-Avila V, Heath N, Hu A. 1987. Determination of purgeable halocarbons and aromatics by photoionization and Hall electrolytic conductivity detectors connected in series. *J Chromatog Sci* 25:356-363.
- \*Lovegren NV, Fisher GS, Lehendre MG, et al. 1979. Volatile constituents of dried legumes. *J Agric Food Chem* 27:851-853.
- \*Lundberg I, Ekdahl M, Kronevi T, et al. 1986. Relative hepatotoxicity of some industrial solvents after intraperitoneal injection or inhalation exposure in rats. *Environ Res* 40:411-420.
- \*Lunt RL. 1953. Delayed chloroform poisoning in obstetric practice. *Br Med J* 1:489-490.
- \*Lurker PA, Clark CS, Elia VJ, et al. 1983. Worker exposure to chlorinated organic compounds from the activated-sludge wastewater treatment process. *Am Ind Hyg Assoc J* 44: 109-112.
- \*Lyman WJ, Reehl WF, Rosenblatt DH. 1982. *Handbook of Chemical Property Estimation Methods. Environmental behavior of organic compounds.* New York, NY: McGraw-Hill Book Co, 15-9 to 15-31.
- \*Mabey W, Mill T. 1978. Critical review of hydrolysis of organic compounds in water under environmental conditions. *J Phys Chem Ref Data* 7:383-415.
- \*Mailhot H. 1987. Prediction of algal bioaccumulation and uptake of nine organic compounds by ten physicochemical properties. *Environ Sci Technol* 21: 1009- 1013.
- \*Malten KE, Spruit D, Boemaars HGM, et al. 1968. Horny layer injury by solvents. *Berufsdermatosen* 16: 135- 147.

## 8. REFERENCES

- \*Mansuy D, Beaune P, et al. 1977. Evidence for phosgene formation during liver microsomal oxidation of chloroform. *Biochem Biophys Res Commun* 79(2):5 13-5 17.
- \*Masuda Y, Nakayama N. 1982. Protective effect of diethyldithiocarbamate and carbon disulfide against liver injury induced by various hepatotoxic agents. *Biochem Pharmacol* 31:2713-2725.
- \*Masuda Y, Nakayama N. 1983. Protective action of diethyldithiocarbamate and carbon disulfide against renal injury induced by chloroform in mice. *Biochem Pharmacol* 32 (21)3127-3135.
- Masuda Y, Yano I, Murano T. 1980. Comparative studies on the hepatotoxic actions of chloroform and related halogenomethanes in normal and phenobarbital-pretreated animals. *J Pharmacobio-Dynamics* 3:53-64.
- \*Matsushima T. 1994. Carcinogenesis study of chloroform (inhalation). Japan Bioassay Laboratory, Japan Industrial Safety and Health Association, Kanagawa, Japan.
- McCarty LP, Flannagan DC, Randall SA, et al. 1992. Acute toxicity in rats of chlorinated hydrocarbons given via the intratracheal route. *Human Exper Toxicol* 11: 173- 177.
- \*McCarty LP, Malek RS, Larsen ER. 1979. The effects of deuteration on the metabolism of halogenated anesthetics in the rat. *Anesthesiology* 5 1: 106-110.
- \*McDonald MN, Vire DE. 1992. Chloroform in the endodontic operator. *J Endodontics* 18(6):301-303.
- McGee MB, Jejurikar SG, VanBerkom LC. 1987. A double homicide as a result of chloroform poisoning. *J Forensic Sci* 32: 1453-1459.
- \*McGeehin MA, Reif JS, Becher JC, et al. 1993. Case control study of bladder cancer and water disinfection methods in Colorado. *American Journal of Epidemiology* 138(7):493-501.
- \*McKone TE. 1993. Linking a PBPK model for chloroform with measured breath concentrations in showers: implications for dermal exposure models. *J Expo Anal Environ Epidemiol* 3(3):339-365.
- \*McLean AEM. 1970. The effect of protein deficiency and microsomal enzyme induction by DDT and phenobarbitone on the acute toxicity of chloroform and a pyrrolizidine alkaloid, retrorsine. *Br J Exp Pathol* 51:317-321.
- \*McMartin DN, O'Connor JA Jr., Kaminsky LS. 1981. Effects of differential changes in rat hepatic and renal cytochrome p-450 concentrations on hepatotoxicity and nephrotoxicity of chloroform. *Res Commun Chem Pathol Pharmacol* 31:99- 110.
- Mehendale HM, Purushotham KR, Lockard VG. 1989. The time course of liver injury and [3H]thymidine incorporation in chlordecone-potentiated CHC13 hepatotoxicity. *Exp Mol Pathol* 51:31-47.
- \*Merck Index. 1989. Merck index: An encyclopedia of chemicals, drugs, and biologicals. 11th ed. Budavari S, ed. Rahway NJ: Merck & Co., Inc.

## 8. REFERENCES

- \*Mery S, Larson JL, Butterworth BE, et al. 1994. Nasal toxicity of chloroform in male F-344 rats and female B6C3F<sub>1</sub> mice following a 1-week inhalation exposure. *Toxicol Appl Pharmacol* 125(2):214-227.
- \*Mieville R. 1992. High efficiency activated carbon for drinking water treatment. File 266, Federal Research in Progress.
- \*Miller RE, Randtke SJ, Hathaway LR, et al. 1990. Organic carbon and THM formation potential in Kansas groundwaters. *Journal of the American Water Works Association* 82:49-62.
- \*Mink FL, Brown TJ, Rickabaugh J. 1986. Absorption, distribution and excretion of C-trihalomethanes in mice and rats. *Bull Environ Contam Toxicol* 37:752-758.
- \*Mirsalis JC, Tyson CK, Butterworth BE. 1982. Detection of genotoxic carcinogens in the *in vivo-in vitro* hepatocyte DNA repair assay. *Environ Mutagen* 4:553-562.
- \*Mitchell AD, Myhr BC, Rudd CJ, et al. 1988. Evaluation of the L5178Y mouse lymphoma cell system: Methods used and chemicals evaluated. *Environ Mol Mutagen* 12(Suppl 13):1-18.
- Moody DE, Smuckler EA. 1986. Disturbances in hepatic heme metabolism in rats administered alkyl halides. *Toxicol Lett* 32:209-214.
- \*Moore DH, Chasseaud LF, Majeed SK, et al. 1982. The effect of dose and vehicle on early tissue damage and regenerative activity after chloroform administration to mice. *Food Chem Toxicol* 20:951-954.
- \*Morimoto K, Koizumi A. 1983. Trihalomethanes induce sister chromatid exchanges in human lymphocytes *in vitro* and mouse bone marrow cells *in vivo*. *Environ Res* 32:72-79.
- Muller W. 1987. Chloroform: Detection of gene mutations in somatic cells in culture. HGPRT-test with V79 cells. Frankfurt, Germany: Pharma Research Toxicology and Pathology, Hoechst Aktiengesellschaft.
- \*Munson AE, Sain LE, Sanders VM, et al. 1982. Toxicology of organic drinking water contaminants: Trichloromethane, bromodichloromethane, dibromochloromethane and tribromomethane. *Environ Health Perspect* 46: 117- 126.
- \*Murray FJ, Schwetz BA, McBride JB, et al. 1979. Toxicity of inhaled chloroform in pregnant mice and their offspring. *Toxicol Appl Pharmacol* 50:515-522.
- \*Nakajima T, Elovaara E, Okino T, et al. 1995. Different contributions of cytochrome P450 2E1 and P450 2B1/2 to chloroform hepatotoxicity in rat. *Toxicol Appl Pharm* 133:215-222.
- \*Namkung E, Rittmann BE. 1987. Estimating volatile organic compound emissions from publicly owned treatment works. *J Water Pollut Control Fed* 59:670-678.
- \*NAS. 1980. Drinking water and health. Vol. 3. National Academy of Science. Washington, D.C.

## 8. REFERENCES

- \*NAS/NRC. 1989. Biologic markers in reproductive toxicology. National Academy of Sciences/ National Research Council. Washington, DC: National Academy Press, 15-35.
- \*Nashelsky M, Dix JD, Adelstein H, et al. 1995. Homicide facilitated by inhalation of chloroform. *Journal of Forensic Sciences* 40(1): 134-138.
- \*NATICH. 1992. Acceptable ambient concentration guidelines or standards. In: NATICH data base report on state, local and EPA air toxics activities. National Air Toxics Information Clearinghouse, Office of Air Quality Planning and Standards, U.S. Environmental Protection Agency, State and Territorial Air Pollution Program Administrators, Association of Local Air Pollution Control Officials., 99.
- \*NCI. 1976. Report on carcinogenesis bioassay of chloroform. Bethesda, MD: Carcinogenesis Program, National Cancer Institute.
- \*Needham LL, Ashley DL, Hill RH Jr., et al. 1990. A program for assessing background levels of 52 organic toxicants in the U.S. population. Pp. 453-458. *Indoor Air '90: The Fifth International Conference on Indoor Air Quality and Climate*.
- \*Newell GW, Dilley JV. 1978. Teratology and acute toxicology of selected chemical pesticides administered by inhalation. Report by Stanford Research Institute, Menlo Park, CA to Health Effects Research Laboratory, Office of Research and Development, U.S. Environmental Protection Agency, Research Triangle Park, NC.
- \*NFPA. 1994. Fire Protection Guide to Hazardous Materials, 11th edition, National Fire Protection Association, Quincy, MA.
- \*Nicholson AA, Meresz O, Lemyk B. 1977. Determination of free and total potential halofonns in drinking water. *Anal Chem* 49:814-819.
- \*Nicholson BC, Maguire BP, Bursill DB. 1984. Henry's law constants for the trihalomethanes: Effects of water composition and temperature. *Environ Sci Technol* 28:5 18-521.
- NIOSH. 1974. Criteria for a recommended standard - occupational exposure to chloroform. Rockville, MD: National Institute for Occupational Safety and Health.
- NIOSH. 1977. Criteria for a recommended standard - occupational exposure to waste anesthetic gases and vapors. Publ. No. (NIOSH) 77-140. Washington, DC: Department of Health, Education, and Welfare.
- \*NIOSH. 1984. Current awareness file. Registry of Toxic Effects of Chemical Substances (RTECS). Cincinnati, OH: U.S. Department of Health and Human Services, Public Health Service, Centers for Disease Control, National Institute for Occupational Safety and Health.
- \*NIOSH. 1987. NIOSH manual of analytical methods. 3rd ed. Cincinnati, OH: U.S. Department of Health and Human Services, Public Health Service, Centers for Disease Control, National Institute for Occupational Safety and Health. DHHS (NIOSH) publication no. 84-100, revision 1.

## 8. REFERENCES

- \*NIOSH. 1989. National Occupational Exposure Survey (NOES) as of March 29, 1989. Cincinnati, OH: U.S. Department of Health and Human Services, Public Health Service, Centers for Disease Control, National Institute for Occupational Safety and Health.
- \*NIOSH. 1990. Pocket guide to chemical hazards. DHHS (NIOSH) Publ. No. 90-117. Cincinnati, OH: U.S. Department of Health and Human Services, Public Health Service, Centers for Disease Control, National Institute for Occupational Safety and Health.
- \*NIOSH. 1992. NIOSH recommendations for occupational safety and health, compendium of policy documents and statements. Cincinnati, OH.
- \*NIOSH. 1994. Method 1003, halogenated hydrocarbons, NIOSH manual of analytical methods 4th edition, U. S. Department of Health and Human Services, Public Health Service, Centers for Disease Control, National Institute for Occupational Safety and Health.
- \*NOES. 1991. National Occupational Exposure Survey (1981- 1983): Chloroform. Cincinnati, OH: U.S. Department of Health and Human Services, National Institute for Occupational Safety and Health.
- \*NRC/NAS. 1993. Telecommunication regarding compilation of current EEGLs and CEGLs. National Research Council/National Academy of Science, Washington, D.C.
- \*NTDB. 1994. National Trade Data Bank. Washington, DC: UCDOC, Bureau of the Census (database on CD-ROM).
- \*NTDB. 1995. National Trade Data Bank. Washington, DC: UCDOC, Bureau of the Census (database on CD-ROM).
- \*NTP. 1989. Fifth annual report on carcinogens. Summary 1989. Report to the National Institute of Environmental Health Sciences, Research Triangle Park, NC by Technical Resources, Inc., Rockville, MD. NTP-89-239.
- \*NTP. 1995. Printed long term technical reports and short term toxicity study reports. National Toxicology Program. Management status report. Division of Toxicology research and Testing. National Institute of Environmental Health Sciences. July 7, 1995.
- O'Hara TM, Borzelleca JF, Clarke EC, et al. 1989. A CC14/HC13 interaction study in isolated hepatocytes: Selection of a vehicle. *Fundam Appl Toxicol* 13:605-615.
- \*Ohio River Valley Water Sanitation Commission. 1980. Assessment of water quality conditions. Ohio River Mainstream 1978-9. Cincinnati, OH: Ohio River Valley Water Sanitation Commission.
- \*Ohio River Valley Water Sanitation Commission. 1982. Assessment of water quality conditions. Ohio River mainstream 1980-81. Cincinnati, OH: Ohio River Valley Water Sanitation Commission.
- OHM/TADS. 1990. Oil and Hazardous Materials Technical Assistance Data System.
- \*OSHA. 1974. U.S. Occupational Safety and Health Administration. Code of Federal Regulations. 29 CFR 1910.



## 8. REFERENCES

- \*OSHA. 1979. Method No. 05. Collection on charcoal adsorbent, desorption with carbon disulfide, analysis by gas chromatography using a flame ionization detector. Organic Methods Evaluation Branch, Occupational Safety and Health Administration Analytical Lab, Salt Lake City, UT. May 1979.
- \*OTA. 1990. Neurotoxicology: Identifying and controlling poisons of the nervous system. Office of Technology Assessment, Washington, DC. OTA-BA-438.
- \*Otson R, Fellin P, Tran Q. 1994. VOCs in representative Canadian residences. *Atmospheric Environment* 28(22):3563-3569.
- Oura E, Raiha NCR, Suomalainen H. 1966. Influence of some alcohols and narcotics on the adenosine phosphates in the liver of the mouse. *Ann Med Exp Biol Fenn* 45:57-62.
- \*Paasivirta J, Knuutinen J, Knuutila M, et al. 1988. Lignin and organic chlorine compounds in lake water and the role of the chlorobleaching effluents. *Chemosphere*. 17:147-158.
- \*Palmer AK, Street AE, Roe JC, et al. 1979. Safety evaluation of toothpaste containing chloroform. II. Long term studies in rats. *J Environ Pathol Toxicol* 2:821-833.
- \*Park KS, Sorensen DL, Sims JL, et al. 1988. Volatilization of wastewater trace organics in slow rate land treatment systems. *Haz Waste Haz Mat* 5 (3):219-229.
- Parkki MG. 1986. Biotransformation reactions and active metabolites. In: Riihimaki V, Ulfvarson U, eds. Safety and health aspects of organic solvents. Proceedings of the international course on safety and health aspects of organic solvents held in Espoo, Finland, April 22-26, 1985. New York, NY: Alan R. Liss, Inc., 89-96.
- \*Parsons JS, Mitzner S. 1975. Gas chromatographic method for concentration and analysis of traces of industrial organic pollutants in environmental air and stacks. *Environ Sci Technol* 9:1053-1058.
- Paul BB, Rubinstein D. 1963. Metabolism of carbon tetrachloride and chloroform by the rat. *J Pharmacol Exp Ther* 141:141-148.
- \*Pellizzari ED, Erickson MD, Zweidinger RA. 1979. Formulation of preliminary assessment of halogenated organic compounds in man and environmental media. Research Triangle Park, NC: U.S. Environmental Protection Agency. EPA 560/13-79-006.
- \*Pellizzari ED, Hartwell TD, Harris BSH III, et al. 1982. Purgeable organic compounds in mother's milk. *Bull Environ Contam Toxicol* 28:322-328.
- \*Pellizzari ED, Hartwell TD, Perritt RL, et al. 1986. Comparison of indoor and outdoor residential levels of volatile organic chemicals in five U.S. geographical areas. *Environ Intern* 12:619-623.
- \*Peoples AJ, Pfaffenberger CD, Shafik TM, et al. 1979. Determination of volatile purgeable halogenated hydrocarbons in human adipose tissue and blood serum. *Bull Environ Contam Toxicol* 23:244-249.

## 8. REFERENCES

- \*Pereira MA. 1994. Route of administration determines whether chloroform enhances or inhibits cell proliferation in the liver of B6C3F1 mice. *Fundam Appl Toxicol* 23(1):87-92.
- Pereira MA, Daniel FB, Lin ELC. 1984. Relationship between metabolism of haloacetonitriles and chloroform and their carcinogenic activity. In: Jolley RL, Bull RJ, Davis WP, et al., eds. *Water Chlorination: Chemistry, Environmental Impact and Health Effects*. Volume 5. Lewis Publishers, Inc., 229-236.
- Pereira MA, Lin LC, Lippitt JM, et al. 1982. Trihalomethanes as initiators and promoters of carcinogenesis. *Environ Health Perspect* 46:151-156.
- Perera F, Brennan T, Fouts JR. 1989. Comment on the significance of positive carcinogenicity studies using gavage as the route of exposure. *Environ Health Perspect* 79:315-321.
- \*Perocco P, Prodi G. 1981. DNA damage by haloalkanes in human lymphocytes cultured in vitro. *Cancer Lett* 13:213-218.
- \*Petrelli G, Siepi G, Miligi L, et al. 1993. Solvents in pesticides. *Stand J Work Environ Health* 19(1):63-65.
- \*Pfaffenberger CD, Peoples AJ, Enos HF. 1980. Distribution of volatile halogenated organic compounds between rat blood serum and adipose tissue. *Int J Environ Anal Chem* 8:55-65.
- \*Phillips M, Greenberg J. 1992. Ion-trap detection of volatile organic compounds in alveolar breath. *Clin Chem (Winston-Salem, N. C.)* 38(1):60-5.
- \*Phoon WH, Goh KT, Lee LT, et al. 1983. Toxic jaundice from occupational exposure to chloroform. *Med J Malaysia* 38:31-34.
- \*Picardal FW, Arnold RG, Couch H, et al. 1993. Involvement of cytochromes in the anaerobic biotransformation of tetrachloromethane by *Shewanella putrefaciens* 200. *Appl Environ Microbiol* 59(11):3763-3770.
- \*Piersol GM, Tumen HJ, Kau LS. 1933. Fatal poisoning following the ingestion of chloroform. *Med Clin North Am* 17:587-601.
- \*Piwoni MD, Wilson JT, Walters DM, et al. 1986. Behavior of organic pollutants during rapid-infiltration of wastewater into soil. I. Processes, definition, and characterization using a microcosm. *Haz Waste Haz Mat* 3:43-55.
- \*Pleil JD, Lindstrom AB. 1995. Collection of a single alveolar exhaled breath for volatile organic compounds analysis. *Am J Ind Med* 28(1):109-121.
- \*Plumb RH Jr. 1987. A comparison of ground water monitoring data from CERCLA and RCRA sites. *Ground Water Monitoring Review* 7:94-100.
- \*Pohl LR, Bhooshan B, Whittaker NF, et al. 1977. Phosgene: a metabolite of chloroform. *Biochem Biophys Res Commun* 79(3):684-691.

## 8. REFERENCES

- \*Pohl LR, Branchflower RV, Highet RJ, et al. 1981. The formation of diglutathionyl dithiocarbonate as a metabolite of chloroform, bromotrichloromethane, and carbon tetrachloride. *Drug Metab Dispos* 9:334-339.
- \*Pohl LR, George JW, Satoh H. 1984. Strain and sex differences in chloroform-induced nephrotoxicity: Different rates of metabolism of chloroform to phosgene by the mouse kidney. *Drug Metab Dispos* 12:304-308.
- \*Pohl LR, Gillette JR. 1984. Determination of toxic pathways of metabolism by deuterium substitution. *Drug Metab Rev* 15: 1335-1351.
- \*Pohl LR, Martin JL, George JW. 1980b. Mechanism of metabolic activation of chloroform by rat liver microsomes. *Biochem Pharmacol* 29:3271-3276.
- \*Pohl LR, Martin JL, Taburet AM, et al. 1980a. Oxidative bioaction of haloforms into hepatotoxins. *Microsomes, Drug Oxidations, and Chemical Carcinogenesis* 2:881-884.
- Purushotham KR, Lockard VG, Mehendale HM. 1988. Amplification of chloroform hepatotoxicity and lethality by dietary chlordecone (Kepone) in mice. *Toxicol Pathol* 16:27-34.
- Raabe OG. 1986. Inhalation uptake of selected chemical vapors at trace levels. Report by Laboratory for Energy-Related Health Research, School of Veterinary Medicine, University of California-Davis, Davis, CA, to Air Resources Board, State of California, Sacramento, CA.
- \*Ramsey JC, Andersen ME. 1984. A physiologically-based description of the inhalation pharmacokinetics of styrene in rats and humans. *Toxicol Appl Pharmacol* 73: 159-175.
- \*Ramus TL, Hein SJ, Thomas LC. 1984. Determinations of chlorinated hydrocarbons by gas chromatography using response factors calibration. *J Chromatogr* 3 14:243-25 1.
- \*Rando RJ, Poovey HG, Chang S-N. 1993. Collection and chemical derivatization of airborne phosgene with 1-(2-pyridyl)-piperazine and determination by high performance liquid chromatography. *J Liquid Chromatogr* 16(15):3291-3309.
- \*Rae KN, Virji MA, Maraca MA, et al. 1993. Role of serum markers for liver function and liver regeneration in the management of chloroform poisoning. *J Anal Toxicol* 17(2):99-102.
- \*Raymer JH, Thomas KW, Cooper SD, et al. 1990. A device for sampling of human alveolar air for the measurement of expired volatile organic compounds. *J Anal Toxicol*. 14:337-344.
- \*Recknagel RO, Glende EA, Waller RL, et al. 1982. Lipid peroxidation: Biochemistry, measurement, and significance in liver cell injury. In: Plaa GL, Hewitt WR, eds. *Toxicology of the Liver*. New York, NY: Raven Press, 213-241.
- \*Reddy TV, Daniel FB, Lin EL, et al. 1992. Chloroform inhibits the development of diethylnitrosamine-initiated, phenobarbital-promoted gamma-glutamyltranspeptidase and placental form glutathione S-transferase-positive foci in rat liver. *Carcinogenesis* 13(8):1325-1330.

## 8. REFERENCES

- Reitz RH, Fox TR, Quast JF. 1982. Mechanistic considerations for carcinogenic risk estimation: Chloroform. *Environ Health Perspect* 46: 163-168.
- Reitz RH, Gehring PJ, Park CN. 1978. Carcinogenic risk estimation for chloroform: An alternative to EPA's procedures. *Food Cosmet Toxicol* 16:511-514.
- \*Reitz RH, Mendrala AL, Corley RA, et al. 1990. Estimating the risk of liver cancer associated with human exposures to chloroform using physiologically based pharmacokinetic modeling. *Toxicol Appl Pharmacol* 105:443-459.
- Reitz RH, Quast JF, Scott WT, et al. 1980. Pharmacokinetics and macromolecular effects of chloroform in rats and mice. Implications for carcinogenic risk estimation. *Water chlorination: environmental impact and health effects* 3:983-993.
- Reuber MD. 1978. Carcinomas and other lesions of the liver in mice ingesting organochlorine pesticides. *Clin Toxicol* 13:231-256.
- \*Reunanen M, Kroneld R. 1982. Determination of volatile halocarbons in raw and drinking water, human serum, and urine by electron capture GC. *J Chromatogr Sci* 20:449-454.
- Reynolds ES, Yee AG. 1967. Liver parenchymal cell injury. V. Relationships between patterns of chloromethane-Cl4 incorporation into constituents of liver *in vivo* and cellular injury. *Lab Invest* 16:591-603.
- \*Rhee E, Speece RE. 1992. Maximal biodegradation rates of chloroform and trichloroethylene in anaerobic treatment. *Water Sci Technol* 25(3): 121- 130
- Robinson D, Mead GC, Barnes KA. 1981. Detection of chloroform in the tissues of freshly eviscerated poultry carcasses exposed to water containing added chlorine or chlorine dioxide. *Bull Environ Contam Toxicol* 27: 145-150.
- \*Roe FJC, Palmer AK, Worden AN. 1979. Safety evaluation of toothpaste containing chloroform. I. Long-term studies in mice. *J Environ Pathol Toxicol* 2:799-819.
- \*Rogers SE, Peterson DL, Lauer WC. 1987. Organic contaminants removal for potable reuse. *J Water Pollut Control Fed* 59:722-732.
- \*Royston GD. 1924. Delayed chloroform poisoning following delivery. *Am J Obstet Gynecol* 10:808-814.
- Rubinstein D, Kanics L. 1964. The conversion of carbon tetrachloride and chloroform to carbon dioxide by rat liver homogenates. *Can J Biochem* 42: 1577-1585.
- Ruth RJ, Klaunig JE, Schultz NE, et al. 1986. Mechanisms of chloroform and carbon tetrachloride toxicity in primary cultured mouse hepatocytes. *Environ Health Perspect* 69:301-305.
- \*Ruddick JA, Villeneuve DC, Chu I. 1983. A teratological assessment of four trihalomethanes in the rat. *J Environ Sci Health B18:333-349.*

## 8. REFERENCES

- \*Sabljić A. 1984. Predictions of the nature and strength of soil sorption of organic pollutants by molecular topology. *J Agric Food Chem* 32:243-246.
- \*San Agustin J, Lim-Sylianco CY. 1978. Mutagenic and clastogenic effects of chloroform. *Bulletin of the Philippine Biochemical Society* 1:17-23.
- \*SANSS. 1990. Structure and Nomenclature Search System. Chemical Information System (CIS) computer database.
- Sato A, Nakajima T. 1984. Dietary carbohydrate- and ethanol-induced alteration of the metabolism and toxicity of chemical substances. *Nutr Cancer* 6:121-132.
- Sato A, Nakajima T. 1987. Pharmacokinetics of organic solvent vapors in relation to their toxicity. *Stand J Work Environ Health* 13:81-93.
- \*Sato A, Nakajima T, Koyama Y. 1981. Dose-related effects of a single dose of ethanol on the metabolism in rat liver of some aromatic and chlorinated hydrocarbons. *Toxicol Appl Pharmacol* 60:8-15.
- Savage RE Jr., DeAngelo AB, Guion C, et al. 1987. Studies on the mechanism of action of chloroform stimulation of rat hepatic ornithine decarboxylase (ODC). *Res Commun Chem Pathol Pharmacol* 58:97-113.
- Savage RE Jr., Nofzinger K, Bedell C, et al. 1989. Chloroform-induced multiple forms of ornithine decarboxylase: Differential sensitivity of forms to enhancement by diethyl maleate and inhibition by ODC-antizyme. *J Toxicol Environ Health* 27:57-64.
- Savage RE Jr., Pereira MA, DeAngelo AB. 1988. Chloroform induction of ornithine decarboxylase antizyme (ODC-AZ) in male rat liver. *J Toxicol Environ Health* 1:97-101.
- Savage RE Jr., Westrich C, Guion C, et al. 1982. Chloroform induction of ornithine decarboxylase activity in rats. *Environ Health Perspect* 46:157-162.
- \*Sawhney BL. 1989. Movement of organic chemicals through landfill and hazardous waste disposal sites. In: *Reactions and movement of organic chemicals in soils*. SSSA special publication no 22, 447-474.
- \*Sax NI. 1979. *Dangerous properties of industrial materials*. 5th ed. New York, NY: Van Nostrand Reinhold, 193.
- \*Scholler KL. 1970. Modification of the effects of chloroform on the rat liver. *Br J Anaesth* 42:603-605.
- \*Schroeder HG. 1965. Acute and delayed chloroform poisoning. *Br J Anaesth* 37:972-975.
- \*Schwetz BA, Leong BKJ, Gehring PJ. 1974. Embryo- and fetotoxicity of inhaled chloroform in rats. *Toxicol Appl Pharmacol* 28:442-451.

## 8. REFERENCES

- \*Seto Y, Tsunoda N, Ohta H, et al. 1993. Determination of chloroform levels in blood using a headspace capillary gas chromatographic method. *J Anal Toxicol* 17(7):415-420.
- \*Shatkin J, Szejnwald-Brown H. 1991. Pharmacokinetics of the dermal route of exposure to volatile organic chemicals in water: a computer simulation model. *Environ Res* 56:90-108.
- Shields PG, Harris CC. 1990. Environmental causes of cancer. *Med Clin North Am* 74:263-277.
- Shubik P, Ritchie AC. 1953. Sensitivity of male dba mice to the toxicity of chloroform as a laboratory hazard. *Science* 117:285.
- \*Simmon VF, Kauhanen K, Tardiff RG. 1977. Mutagenic activity of chemicals identified in drinking water. In: Scott D, Bridges BA, Sobels FH, eds. *Progress in Genetic Toxicology*. Elsevier/North Holland Press. 249-258.
- Sims RC, Sims JL, DuPont RR. 1988. Human health effects assays. *J Water Pollut Control Fed* 60:1093-1106.
- \*Singer PC. 1994. Control of disinfection by-products in drinking water. *J Environ Eng* 120(4):727-744.
- \*Singh HB. 1977. Atmospheric halocarbons: Evidence in favor of reduced average hydroxyl radical concentration in the troposphere. *Geophys Res Lett* 4:101-104.
- \*Singh HB, Salas JL, Smith AJ. 1981. Measurements of some potentially hazardous chemicals in urban environments. *Atmos Environ* 15:601-612.
- \*Singh HB, Salas LJ, Shigeisi H, et al. 1979. Atmospheric distributions, sources and sinks of selected halocarbon, hydrocarbons, SF<sub>6</sub> + N<sub>2</sub>O. Research Triangle Park, NC: U.S. Environmental Protection Agency. EPA 600/3-79-107.
- \*Singh HB, Salas LJ, Stiles RE. 1982. Distribution of selected gaseous organic mutagens and suspect carcinogens in ambient air. *Environ Sci Technol* 16:872-880.
- \*Sipes IG, Krishna G, Gillette JR. 1977. Bioactivation of carbon tetrachloride, chloroform and bromotrichloromethane: Role of cytochrome P-450. *Life Sciences* 20: 1541-1548.
- \*Sittig M. 1994. World-wide limits for toxic and hazardous chemicals in air, water, and soil. Park Ridge, NJ: Noyes Publications.
- \*Smith AA, Volpitto PP, Gramling ZW, et al. 1973. Chloroform, halothane, and regional anesthesia: A comparative study. *Anesth Analg* 52:1-11.
- \*Smith AE, Evans JS. 1995. Uncertainty in fitted estimates of apparent *in vivo* metabolic constants for chloroform. *Fundam Appl Toxicol* 25:29-44.
- Smith JH, Hewitt WR, Hook JB. 1985. Role of intrarenal biotransformation in chloroform-induced nephrotoxicity in rats. *Toxicology* 79:166-174.

## 8. REFERENCES

- \*Smith JH, Hook JB. 1983. Mechanism of chloroform nephrotoxicity. II. *In vitro* evidence for renal metabolism of chloroform in mice. *Toxicol Appl Pharmacol* 70:480-485.
- \*Smith JH, Hook JB. 1984. Mechanism of chloroform nephrotoxicity. III. Renal and hepatic microsomal metabolism of chloroform in mice. *Toxicol Appl Pharmacol* 73:511-524.
- \*Smith JH, Maita K, Sleight SD, et al. 1984. Effect of sex hormone status on chloroform nephrotoxicity and renal mixed function oxidases in mice. *Toxicology* 30:305-316.
- Smith MK, Zenick H, George EL. 1986. Reproductive toxicology of disinfection by-products. *Environ Health Perspect* 69:177-182.
- \*Smyth HF Jr., Carpenter CP, Weil CS, et al. 1962. Range-finding toxicity data: List VI. *Am Ind Hyg Assoc J* 23:95-107.
- \*SRC. 1994a. Syracuse Research Center. Henry's Law Constant Program (HENRYWIN), version 2.50, Serial H0142). Chemical Hazard Assessment Division, Environmental Chemistry Center, Syracuse, NY.
- \*SRC. 1994b. Syracuse Research Center. Aqueous Hydrolysis Rate Program (HYDROWIN) version 1.50a, Serial HYO126). Chemical Hazard Assessment Division, Environmental Chemistry Center, Syracuse, NY.
- \*SRI. 1990. 1990 directory of chemical producers. United States of America. Menlo Park, CA: Stanford Research Institute International.
- \*SRI. 1993. 1993 directory of chemical producers. United States of America. Menlo Park, CA: Stanford Research Institute International.
- \*SRI. 1994. 1994 directory of chemical producers. United States of America. Menlo Park, CA: Stanford Research Institute International.
- \*SRI. 1995. Directory of chemical producers, United States of America. Menlo Park, CA: SRI International.
- \*St-Germain F, Mamer O, Brunet J, et al. 1995. Volatile organic compound analysis by an inertial spray extraction interface coupled to an ion trap mass spectrometer. *Anal Chem* 67:4536-4541.
- \*Stacey NH. 1987a. Reduced glutathione and toxicity of cadmium/chloroform mixtures in isolated rat hepatocytes. *In Vitro Toxicol* 1: 189- 192.
- \*Stacey NH. 1987b. Assessment of the toxicity of chemical mixtures with isolated rat hepatocytes: Cadmium and chloroform. *Fundam Appl Toxicol* 9:616-622.
- Stacey NH. 1989. Toxicity of combinations of chlorinated aliphatic hydrocarbons *in vitro* and *in vivo*. *In Vitro Toxicol* 3:137-143.
- \*Staples CA, Werner AF, Hoogheem TJ. 1985. Assessment of priority pollutant concentrations in the United States using STORET database. *Environ Toxicol Chem* 4: 131-142.

## 8. REFERENCES

- \*State of Kentucky. 1986. 401 KAR 63:022. New or modified sources emitting toxic air pollutants. Natural Resources and Environmental Protection Cabinet, Department for Environmental Protection, Division of Air Pollution (Proposed Regulation).
- \*Stefanovic J, Starsia Z, Murgasova I, et al. 1987. *In vitro* effects of organic solvents on immunity indicators in serum. *J Hyg Epidemiol Microbial Immunol* 31: 1-7.
- \*Stephens RD, Ball ND, Mar DM. 1986. A multimedia study of hazardous waste land fill gas migration. In: *Pollutants in a Multimedia Environment*. New York, NY: Plenum Press, 265-287.
- Stevens JL, Anders MW. 1979. Metabolism of haloforms to carbon monoxide - III. Studies on the mechanism of the reaction. *Biochem Pharmacol* 28:3189-3194.
- \*Stevens JL, Anders MW. 1981. Effect of cysteine, diethyl maleate, and phenobarbital treatments on the hepatotoxicity of [1H]- and [2H]chloroform. *Chem Biol Interact* 37:207-217.
- \*Stoner GD, Conran PB, Greisiger EA, et al. 1986. Comparison of two routes of chemical administration on the lung adenoma response in strain A/J mice. *Toxicol Appl Pharmacol* 82: 19-31.
- \*Storms WW. 1973. Chloroform parties. *J Am Med Assoc* 225:160.
- \*Streete PJ, Ruprah M, Ramsey JD, et al. 1992. Detection and identification of volatile substances by headspace capillary gas chromatography to aid the diagnosis of acute poisoning. *Analyst (London)* 117(7):1111-1127.
- \*Sturrock J. 1977. Lack of mutagenic effect of halothane or chloroform on cultured cells using the azaguanine test system. *Br J Anaesth* 49:207-210.
- \*Suarez-Varela MM, Gonzalez AL. 1994. Chlorination of drinking water and cancer incidence. *J Environ Path Toxicol Oncol* 13(1):39-41.
- \*Suzuki T, Nezu K, Sasaki H, et al. 1994. Cytotoxicity of chlorinated hydrocarbons and lipid peroxidation in isolated rat hepatocytes. *Biol Pharmaceut Bull* 17(1):82-86.
- \*Symons JM, Bellar TA, Carswell JK, et al. 1975. National organic reconnaissance survey for halogenated organics. *Journal of the American Water Works Association* 67:634-647.
- \*Tabak HH, Quave SA, Mashni CI, et al. 1981. Biodegradability studies with organic priority pollutant compounds. *J Water Pollut Control Fed* 53:1503-1518.
- \*Taylor DC, Brown DM, Keeble R, et al. 1974. Metabolism of chloroform - II. A sex difference in the metabolism of [<sup>14</sup>C]chloroform in mice. *Xenobiotica* 4: 165-174.
- \*Testai E, DiMarzio S, Vittiozzi L. 1990. Multiple activation of chloroform in hepatic microsomes from uninduced B6C3F<sub>1</sub> mice. *Toxicol Appl Pharmacol* 104:496-503.
- \*Testai E, Gramenzi F, Di Marzio S, et al. 1987. Oxidative and reductive biotransformation of chloroform in mouse liver microsomes. *Mechanisms and Models in Toxicology Arch Toxicol Suppl* 11:42-44.



## 8. REFERENCES

Testai E, Vittozzi L. 1986. Biochemical alterations elicited in rat liver microsomes by oxidation and reduction products of chloroform metabolism. *Chem Biol Interact* 49:157-171.

Thalhammer T, Kaschnitz R, Mittermayer K, et al. 1993. Organic solvents increase membrane fluidity and affect bile flow and K<sup>+</sup> transport in rat liver. *Biochem Pharmacol* 46(7):1207-1215.

Theiss JC, Stoner GD, Shimkin MB, et al. 1977. Test for carcinogenicity of organic contaminants of United States drinking waters by pulmonary tumor response in strain A mice. *Cancer Res* 37:2717-2720.

\*Thompson DJ, Warner SD, Robinson VB. 1974. Teratology studies on orally administered chloroform in the rat and rabbit. *Toxicol Appl Pharmacol* 29:348-357.

\*Thompson DW. 1994. Determination of volatile organic contaminants in bulk oils (edible, injectable, and other internal medicinal) by purge-and-trap gas chromatography/mass spectrometry. *J AOAC Int* 77(3):647-654.

\*Topham JC. 1980. Do induced sperm-head abnormalities in mice specifically identify mammalian mutagen's rather than carcinogens? *Mutat Res* 74:379-387.

\*Toraason M, Breitenstein MJ, Wey HE. 1992. Reversible inhibition of intercellular communication among cardiac myocytes by halogenated hydrocarbons. *Fundam Appl Toxicol* 18(1):59-65.

\*Torkelson TR, Oyen F, Rowe VK. 1976. The toxicity of chloroform as determined by single and repeated exposure of laboratory animals. *Am Ind Hyg Assoc J* 37:697-705.

\*Townsend E. 1939. Acute yellow atrophy of the liver. Two cases, with one recovery. *Br Med J* 2:558-560.

\*Travis CC, Holton GA, Etnier EL, et al. 1986. Assessment of inhalation and ingestion population exposures from incinerated hazardous wastes. *Environ Int* 12:533-540.

\*TRI92. 1994. Toxics Release Inventory 1992. Office of Toxic Substances, U.S. Environmental Protection Agency, Washington, DC.

\*TRI93. 1995. Toxics Release Inventory 1992. Office of Toxic Substances, U.S. Environmental Protection Agency, Washington, DC.

\*Tsuruta H. 1975. Percutaneous absorption of organic solvents. 1) Comparative study of the *in vivo* percutaneous absorption of chlorinated solvents in mice. *Ind Health* 13:227-236.

\*Tumasonis CF, McMartin DN, Bush B. 1985. Lifetime toxicity of chloroform and bromodichloromethane when administered over a lifetime in rats. *Ecotoxicol Environ Safety* 9:233-240.

\*Tumasonis CF, McMartin DN, Bush B. 1987. Toxicity of chloroform and bromodichloromethane when administered over a lifetime in rats. *J Environ Pathol Toxicol Oncol* 7:55-64.

## 8. REFERENCES

\*Uchrin CG, Mangels G. 1986. Chloroform sorption to New Jersey coastal plain groundwater aquifer solids. *Environ Toxicol Chem* 5:339-343.

Uehleke H, Werner T. 1975. A comparative study on the irreversible binding of labeled halothane, trichlorofluoromethane, chloroform, and carbon tetrachloride to hepatic protein and lipids *in vitro* and *in vivo*. *Arch Toxicol* 34:289-308.

\*Uehleke H, Werner T, Greim H, et al. 1977. Metabolic activation of haloalkanes and tests *in vitro* for mutagenicity. *Xenobiotica* 7:393-400.

\*USITC. 1989. Synthetic organic chemicals, United States production and sales, 1988. USITC publication no 2219. Washington, DC: U.S. International Trade Commission.

Utidiyan HMD. 1976. Criteria Documents. 1. Recommendations for a chloroform standard. *J Occup Med* 18:253-257.

\*Vallejo-Cordoba B, Nakai S. 1993. Using a simultaneous factor optimization approach for detection of volatiles in milk by dynamic headspace gas chromatographic analysis. *J Agric Food Chem* 41(12):2378-2384.

\*Valzelli L, Kozak W, Skorupska M. 1988. Effect of some anesthetics on memory and exploration. *Methods and Findings in Experimental and Clinical Pharmacology* 10(4):239-242.

\*Van Abbe NJ et al. 1982. Bacterial mutagenicity studies on chloroform *in vitro*. *Food Chem Toxicol* 20:557-561.

\*van Beelen P, van Vlaardingen PLA, Fleuren-Kemila AK. 1994. Toxic effects of pollutants on the mineralization of chloroform in river sediments. *Ecotoxicol Environ Safety* 27(2):158-167.

\*Van Dyke RA, Chenoweth MB, Poznak AV. 1964. Metabolism of volatile anesthetics - I. Conversion *in vivo* of several anesthetics to  $^{14}\text{CO}_2$  and chloride. *Biochem Pharmacol* 13:1239-1247.

\*van Vlaardigen PLA, van Beelen P. 1992. Toxic effects of pollutants on methane production in sediments of the River Rhine. *Bull Environ Contam Toxicol* 49: 780-786.

\*van Vlaardingen PLA, van Beelen P. 1992. Toxic Effects of pollutants on methane production in sediments of the River Rhine. *Bull Environ Contam Toxicol* 49(5):780-786.

\*Varma MM, Ampy FR, Verma K, et al. 1988. *In vitro* mutagenicity of water contaminants in complex mixtures. *J Appl Toxicol* 8:243-248.

\*Veith GD, Macek KJ, Petrocelli SR, et al. 1980. An evaluation of using partition coefficients and water solubility to estimate bioconcentration factors for organic chemicals in fish. *Aquatic Toxicology ASTM SIP 707*. American Society for Testing and Materials 116-129.

\*Verschueren K, ed. 1983. *Handbook of Environmental Data on Organic Chemicals*. 2nd ed. New York, NY: Van Nostrand Reinhold Company, 606-611.

## 8. REFERENCES

Vesell ES, Lang CM, White WJ, et al. 1976. Environmental and genetic factors affecting the response of laboratory animals to drugs. *Fed Proc* 35:1125-1132.

\*Van Oettingen WF. 1964. The halogenated hydrocarbons of industrial and toxicologic importance. Amsterdam: Elsevier Publishing Co.

\*Wallace CJ. 1950. Hepatitis and nephrosis due to cough syrup containing chloroform. *Calif Med* 73:144-243.

\*Wallace LA. 1987. The total exposure assessment methodology (TEAM) study. EPA 600/56-87/002.

Wallace LA. 1989. The total exposure assessment methodology (TEAM) study: An analysis of exposures, sources, and risks associated with four volatile organic chemicals. *J Am Coll Toxicol* 8:883-895.

\*Wallace LA. 1995. Human exposure to environmental pollutants: A decade of experience. *Clinical and Experimental Allergy* 25(1):4-9.

\*Wallace LA, Hartwell TD, Perritt K, et al. 1987d. The influence of personal activities on exposure to volatile organic compounds. In: *Proceedings of the 4th International Conference: Indoor Air Quality and Climate, Germany, 2-18 1 to 2-185*.

\*Wallace LA, Jungers R, Sheldon L, et al. 1987c. Volatile organic chemicals in 10 public-access buildings. EPA 600/D-87/152.

\*Wallace LA, Pellizzari ED, Hartwell TD, et al. 1984. Personal exposure to volatile organic compounds. I. Direct measurements in breathing-zone air, drinking water, food, and exhaled breath. *Environ Res* 35:293-319.

\*Wallace LA, Pellizzari ED, Hartwell TD, et al. 1986b. Concentrations of 20 volatile organic compounds in the air and drinking water of 350 residents of New Jersey compared with concentrations in their exhaled breath. *J Occup Med* 28:603-608.

\*Wallace LA, Pellizzari ED, Hartwell TD, et al. 1987a. The TEAM study: Personal exposures to toxic substances in air, drinking water, and breath of 400 residents of New Jersey, North Carolina, and North Dakota. *Environ Res* 43:290-307.

\*Wallace LA, Pellizzari ED, Hartwell TD, et al. 1988. The California TEAM study: Breath concentrations and personal exposures to 26 volatile compounds in air and drinking water of 188 residents of Los Angeles, Antioch, and Pittsburgh, CA. *Atmos Environ* 22:2141-2163.

\*Wallace LA, Pellizzari ED, Hartwell TD, et al. 1989. The influence of personal activities on exposure to volatile organic compounds. *Environ Res* 50:37-55.

\*Wallace LA, Pellizzari ED, Leaderer B, et al. 1987b. Emissions of volatile organic compounds from building materials and consumer products. *Atmos Environ* 21:385-395.

## 8. REFERENCES

\*Wallace LA, Pellizzari ED, Sheldon L, et al. 1986a. The total exposure assessment methodology (TEAM) study: Direct measurement of personal exposures through air and water for 600 residents of several U.S. cities. In: Cohen Y, ed. *Pollutants in a Multimedia Environment*. New York, NY: Plenum Press, 289-315.

Walter CB. 1982. *Safe handling of chemical carcinogens, mutagens, teratogens, and highly toxic substances*. Ann Arbor, MI: Ann Arbor Science.

\*Wang P-Y, Kaneko T, Sato A, et al. 1995. Dose and route dependent alteration of metabolism and toxicity of chloroform in fed and fasting rats. *Toxicol Appl Pharm* 135(1):119-126.

\*Wang P-Y, Kaneko T, Tsukada H, et al. 1994. Dose and route dependency of metabolism and toxicity of chloroform in ethanol-treated rats. *Arch Toxicol* 69:18-23.

\*Weast RC, ed. 1988. *CRC Handbook of Chemistry and Physics*. 69th edition 1988-1989. Boca Raton, FL: CRC Press, Inc. Pg C-350.

\*Westrick JJ, Mello JW, Thomas RF. 1989. The groundwater supply survey. *J Am Water Works Assoc* 76:52-59.

\*Whitaker AM, Jones CS. 1965. Report of 1500 chloroform anesthetics administered with a precision vaporizer. *Anesth Analg* 44:60-65.

\*White AE, Takehisa S, Eger EI, et al. 1979. Sister chromatid exchanges induced by inhaled anesthetics. *Anesthesiology* 50:426-430.

\*WHO. 1984. *Guidelines for drinking-water quality*. World Health Organization, Geneva, Switzerland.

Wikberg JES, Hede AR, Post C. 1987. Effects of halothane and other chlorinated hydrocarbons on  $\alpha_2$ -adrenoceptors in the mouse cortex. *Pharmacol Toxicol* 61:271-277.

\*Wilson J, Enfield CG, Dunlap WJ, et al. 1981. Transport and fate of selected organic pollutants in a sandy soil. *J Environ Qual* 10:501-506.

\*Withey JR, Collins BT, Collins PG. 1983. Effect of vehicle on the pharmacokinetics and uptake of four halogenated hydrocarbons from the gastrointestinal tract of the rat. *J Appl Toxicol* 3:249-253.

\*Wolf CR, Mansuy D, Nastainczyk W, et al. 1977. The reduction of polyhalogenated methanes by liver microsomal cytochrome P-450. *Mol Pharmacol* 13:698-705.

\*Wood JA, Porter ML. 1987. Hazardous pollutants in class II landfills. *J Air Pollut Control Assoc* 37:609-615.

\*Yang M, Wang L, Xie G, et al. 1993. Effects of intermediate metabolites of 37 xenobiotics on the catalytic activities of reconstituted cytochrome P-450IIB 1 and P-450IA 1 enzyme systems. *Biomed Environ Sci* 6:8-26.

## 8. REFERENCES

Yang RSH, Rauckman EJ. 1987. Toxicological studies of chemical mixtures of environmental concern at the National Toxicology Program: Health effects of groundwater contaminants. *Toxicology* 47: 15-34.

\*Young TB, Kanarek MS, Tsiatis AA. 1981. Epidemiologic study of drinking water chlorination and Wisconsin female cancer mortality. *J Natl Cancer Inst* 67:1191-1198.

\*Zepp RG, Braun AM, Hoigne J, et al. 1987. Photoproduction of hydrated electrons from natural organic solutes in aquatic environments. *Environ Sci Technol* 21:485-490.

\*Zierler S, Feingold L, Danley RA, et al. 1988. Bladder cancer in Massachusetts related to chlorinated chloraminated drinking water: A case control study. *Archives of Environmental Health* 43(2): 195-200.

Zogorski JS. 1984. Experience in monitoring domestic water sources and process waters for trace organics. *J Environ Sci Health A19*:233-249.

## 9. GLOSSARY

**Acute Exposure-Exposure--** to a chemical for a duration of 14 days or less, as specified in the Toxicological Profiles.

**Adsorption Coefficient ( $K_{oc}$ )--**The ratio of the amount of a chemical adsorbed per unit weight of organic carbon in the soil or sediment to the concentration of the chemical in solution at equilibrium.

**Adsorption Ratio ( $K_d$ )--**The amount of a chemical adsorbed by a sediment or soil (i.e., the solid phase) divided by the amount of chemical in the solution phase, which is in equilibrium with the solid phase, at a fixed solid/solution ratio. It is generally expressed in micrograms of chemical sorbed per gram of soil or sediment.

**Bioconcentration Factor (BCF)--**The quotient of the concentration of a chemical in aquatic organisms at a specific time or during a discrete time period of exposure divided by the concentration in the surrounding water at the same time or during the same period.

**Cancer Effect Level (CEL)--**The lowest dose of chemical in a study, or group of studies, that produces significant increases in the incidence of cancer (or tumors) between the exposed population and its appropriate control.

**Carcinogen--**A chemical capable of inducing cancer.

**Ceiling Value--**A concentration of a substance that should not be exceeded, even instantaneously.

**Chronic Exposure--**Exposure to a chemical for 365 days or more, as specified in the Toxicological Profiles.

**Developmental Toxicity--**The occurrence of adverse effects on the developing organism that may result from exposure to a chemical prior to conception (either parent), during prenatal development, or postnatally to the time of sexual maturation. Adverse developmental effects may be detected at any point in the life span of the organism.

**Embryotoxicity and Fetotoxicity--** Any toxic effect on the conceptus as a result of prenatal exposure to a chemical; the distinguishing feature between the two terms is the stage of development during which the insult occurred. The terms, as used here, include malformations and variations, altered growth, and in utero death.

**EPA Health Advisory--**An estimate of acceptable drinking water levels for a chemical substance based on health effects information. A health advisory is not a legally enforceable federal standard, but serves as technical guidance to assist federal, state, and local officials.

**Immediately Dangerous to Life or Health (IDLH)--**The maximum environmental concentration of a contaminant from which one could escape within 30 minutes without any escape-impairing symptoms or irreversible health effects.

**Intermediate Exposure--**Exposure to a chemical for a duration of 15-364 days, as specified in the Toxicological Profiles.

## 9. GLOSSARY

**Immunologic Toxicity**-The occurrence of adverse effects on the immune system that may result from exposure to environmental agents such as chemicals.

***In Vitro***-Isolated from the living organism and artificially maintained, as in a test tube.

***In vivo***-Occurring within the living organism.

**Lethal Concentration<sub>(L0)</sub> (LC<sub>L0</sub>)**-The lowest concentration of a chemical in air which has been reported to have cause death in humans or animals.

**Lethal Concentration<sub>(50)</sub> (LC<sub>50</sub>)**- A calculated concentration of a chemical in air to which exposure for a specific length of time is expected to cause death in 50% of a defined experimental animal population.

**Lethal Dose<sub>(50)</sub> (LD<sub>L0</sub>)** lowest dose of a chemical introduced by a route other than inhalation that is expected to have caused death in humans or animals.

**Lethal Dose<sub>(50)</sub> (LD<sub>50</sub>)**-The dose of a chemical which has been calculated to cause death in 50% of a defined experimental animal population.

**Lethal Time<sub>(50)</sub> (LT<sub>50</sub>)**-A calculated period of time within which a specific concentration of a chemical is expected to cause death in 50% of a defined experimental animal population.

**Lowest-Observed-Adverse-Effect Level (LOAEL)**-The lowest dose of chemical in a study, or group of studies, that produces statistically or biologically significant increases in frequency or severity of adverse effects between the exposed population and its appropriate control.

**Malformations**-Permanent structural changes that may adversely affect survival, development, or function.

**Minimal Risk Level**-An estimate of daily human exposure to a dose of a chemical that is likely to be without an appreciable risk of adverse noncancerous effects over a specified duration of exposure.

**Mutagen**-A substance that causes mutations. A mutation is a change in the genetic material in a body cell. Mutations can lead to birth defects, miscarriages, or cancer.

**Neurotoxicity**-The occurrence of adverse effects on the nervous system following exposure to chemical.

**No-Observed-Adverse-Effect Level (NOAEL)**-The dose of chemical at which there were no statistically or biologically significant increases in frequency or severity of adverse effects seen between the exposed population and its appropriate control. Effects may be produced at this dose, but they are not considered to be adverse.

**Octanol-Water Partition Coefficient (K<sub>ow</sub>)** The equilibrium ratio of the concentrations of a chemical in n-octanol and water, in dilute solution.

**Permissible Exposure Limit (PEL)**-An allowable exposure level in workplace air averaged over an 8-hour shift.

## 9. GLOSSARY

**q<sub>1</sub> \*** -The upper-bound estimate of the low-dose slope of the dose-response curve as determined by the multistage procedure. The q<sub>1</sub>\* can be used to calculate an estimate of carcinogenic potency, the incremental excess cancer risk per unit of exposure (usually µg/L for water, mg/kg/day for food, and µg/m<sup>3</sup> for air).

**Reference Dose (RfD)**-An estimate (with uncertainty spanning perhaps an order of magnitude) of the daily exposure of the human population to a potential hazard that is likely to be without risk of deleterious effects during a lifetime. The RfD is operationally derived from the NOAEL (from animal and human studies) by a consistent application of uncertainty factors that reflect various types of data used to estimate RfDs and an additional modifying factor, which is based on a professional judgment of the entire database on the chemical. The RfDs are not applicable to nonthreshold effects such as cancer.

**Reportable Quantity (RQ)**-The quantity of a hazardous substance that is considered reportable under CERCLA. Reportable quantities are (1) 1 pound or greater or (2) for selected substances, an amount established by regulation either under CERCLA or under Sect. 311 of the Clean Water Act. Quantities are measured over a 24-hour period.

**Reproductive Toxicity**- The occurrence of adverse effects on the reproductive system that may result from exposure to a chemical. The toxicity may be directed to the reproductive organs and/or the related endocrine system. The manifestation of such toxicity may be noted as alterations in sexual behavior, fertility, pregnancy outcomes, or modifications in other functions that are dependent on the integrity of this system.

**Short-Term Exposure Limit (STEL)**-The maximum concentration to which workers can be exposed for up to 15 min continually. No more than four excursions are allowed per day, and there must be at least 60 minutes between exposure periods. The daily TLV-TWA may not be exceeded.

**Target Organ Toxicity**-This term covers a broad range of adverse effects on target organs or physiological systems (e.g., renal, cardiovascular) extending from those arising through a single limited exposure to those assumed over a lifetime of exposure to a chemical.

**Teratogen**-A chemical that causes structural defects that affect the development of an organism.

**Threshold Limit Value (TLV)**-A concentration of a substance to which most workers can be exposed without adverse effect. The TLV may be expressed as a TWA, as a STEL, or as a CL.

**Time-Weighted Average (TWA)**-An allowable exposure concentration averaged over a normal 8-hour workday or 40-hour workweek.

**Toxic Dose (TD<sub>50</sub>)**-A calculated dose of a chemical, introduced by a route other than inhalation, which is expected to cause a specific toxic effect in 50% of a defined experimental animal population.

**Uncertainty Factor (UF)**-A factor used in operationally deriving the RfD from experimental data. UFs are intended to account for (1) the variation in sensitivity among the members of the human population, (2) the uncertainty in extrapolating animal data to the case of human, (3) the uncertainty in extrapolating from data obtained in a study that is of less than lifetime exposure, and (4) the uncertainty in using LOAEL data rather than NOAEL data. Usually each of these factors is set equal to 10.





**APPENDIX A****ATSDR MINIMAL RISK LEVEL**

The Comprehensive Environmental Response, Compensation, and Liability Act (CERCLA) [42 U.S.C. 9601 et seq.], as amended by the Superfund Amendments and Reauthorization Act (SARA) [Pub. L. 99-499], requires that the Agency for Toxic Substances and Disease Registry (ATSDR) develop jointly with the U.S. Environmental Protection Agency (EPA), in order of priority, a list of hazardous substances most commonly found at facilities on the CERCLA National Priorities List (NPL); prepare toxicological profiles for each substance included on the priority list of hazardous substances; and assure the initiation of a research program to fill identified data needs associated with the substances.

The toxicological profiles include an examination, summary, and interpretation of available toxicological information and epidemiologic evaluations of a hazardous substance. During the development of toxicological profiles, Minimal Risk Levels (MRLs) are derived when reliable and sufficient data exist to identify the target organ(s) of effect or the most sensitive health effect(s) for a specific duration for a given route of exposure. An MRL is an estimate of the daily human exposure to a hazardous substance that is likely to be without appreciable risk of adverse noncancer health effects over a specified duration of exposure. MRLs are based on noncancer health effects only and are not based on a consideration of cancer effects. These substance-specific estimates, which are intended to serve as screening levels, are used by ATSDR health assessors to identify contaminants and potential health effects that may be of concern at hazardous waste sites. It is important to note that MRLs are not intended to define clean-up or action levels.

MRLs are derived for hazardous substances using the no-observed-adverse-effect level/uncertainty factor approach. They are below levels that might cause adverse health effects in the people most sensitive to such chemical-induced effects. MRLs are derived for acute (1-14 days), intermediate (15-364 days), and chronic (365 days and longer) durations and for the oral and inhalation routes of exposure. Currently, MRLs for the dermal route of exposure are not derived because ATSDR has not yet identified a method suitable for this route of exposure. MRLs are generally based on the most sensitive chemical-induced end point considered to be of relevance to humans. Serious health effects (such as irreparable damage to the liver or kidneys, or birth defects) are not used as a basis for

## APPENDIX A

establishing MRLs. Exposure to a level above the MRL does not mean that adverse health effects will occur.

MRLs are intended only to serve as a screening tool to help public health professionals decide where to look more closely. They may also be viewed as a mechanism to identify those hazardous waste sites that are not expected to cause adverse health effects. Most MRLs contain a degree of uncertainty because of the lack of precise toxicological information on the people who might be most sensitive (e.g., infants, elderly, nutritionally or immunologically compromised) to the effects of hazardous substances. ATSDR uses a conservative (i.e., protective) approach to address this uncertainty consistent with the public health principle of prevention. Although human data are preferred, MRLs often must be based on animal studies because relevant human studies are lacking. In the absence of evidence to the contrary, ATSDR assumes that humans are more sensitive to the effects of hazardous substance than animals and that certain persons may be particularly sensitive. Thus, the resulting MRL may be as much as a hundredfold below levels that have been shown to be nontoxic in laboratory animals.

Proposed MRLs undergo a rigorous review process: Health Effects/MRL Workgroup reviews within the Division of Toxicology, expert panel peer reviews, and agencywide MRL Workgroup reviews, with participation from other federal agencies and comments from the public. They are subject to change as new information becomes available concomitant with updating the toxicological profiles. Thus, MRLs in the most recent toxicological profiles supersede previously published levels. For additional information regarding MRLs, please contact the Division of Toxicology, Agency for Toxic Substances and Disease Registry, 1600 Clifton Road, Mailstop E-29, Atlanta, Georgia 30333.

## APPENDIX A

**MINIMAL RISK LEVEL (MRL) WORKSHEETS**

Chemical name(s): Chloroform  
CAS number(s): 000067-66-3  
Date: March 19, 1997  
Profile status: Final  
Route:  Inhalation  Oral  
Duration:  Acute  Intermediate  Chronic  
Key to figure: 22  
Species: Mouse  
MRL: 0.1  mg/kg/day  ppm  mg/m<sup>3</sup>

Reference: Larson JL, Wolf DC, Morgan KT, et al. 1994c. The toxicity of 1-week exposures to inhaled chloroform in female B6C3F<sub>1</sub> mice and male F-344 rats. Fund Appl Toxicol 22:431-446.

Experimental design: The authors investigated the ability of chloroform vapors to produce toxicity and regenerative cell proliferation in female B6C3F<sub>1</sub> mice and male Fischer 344 rats. Groups of 5 animals were exposed to 0, 1, 3, 10, 30, 100, or 300 ppm chloroform via inhalation for 6 hours a day for 7 consecutive days. Actual exposure concentrations measured for mice were 0, 1.2, 3.0, 10.0, 29.5, 101, and 288 ppm and for rats were 0, 1.5, 3.1, 10.4, 29.3, 100, and 271 ppm. Necropsies were performed on day 8. Animals were administered bromodeoxyuridine (BrdU) via implanted osmotic pump for the last 3.5 days. Cell proliferation was quantitated as the percentage of cells in S-phase (labeling index = LI) measured by the immunohistochemical detection of BrdU-labeled nuclei.

Effects noted in study and corresponding doses:*Female Mice:*

- 300 ppm:* Respiratory NOAEL; proximal tubules of kidney lined by regenerating epithelium (less serious LOAEL).  
*100 ppm:* Renal NOAEL; centrilobular hepatocyte necrosis and severe diffuse vacuolar degeneration of midzonal and periportal hepatocytes (serious LOAEL); weight loss (less serious LOAEL).  
*30 ppm:* Body weight NOAEL  
*10 ppm:* Mild-to-moderate vacuolar changes in centrilobular hepatocytes (less serious LOAEL).  
*3 ppm:* Hepatic effects NOAEL

*Male Rats:*

- 300 ppm:* Swelling and mild centrilobular vacuolation of hepatocytes (less serious LOAEL).  
*100 ppm:* Hepatic effects NOAEL.  
*30 ppm:* Increased number of S-phase nuclei for tubule cells in the renal cortex (less serious LOAEL).  
*10 ppm:* Renal effect NOAEL; decreased body weight gain (less serious LOAEL); epithelial goblet cell hyperplasia and degeneration of Bowman's glands in olfactory mucosa (less serious LOAEL).  
*3 ppm:* Body weight gain and respiratory NOAEL.

## APPENDIX A

Dose and end point used for MRL derivation:

NOAEL  LOAEL: 3 ppm for hepatic effects in mice

Uncertainty factors used in MRL derivation: 30

1  3  10 (for extrapolation from animals to humans)

1  3  10 (for human variability)

Was a conversion factor used from ppm in food or water to a mg/body weight dose?

If so, explain: No.

If an inhalation study in animals, list conversion factors used in determining human equivalent dose:

For dosimetry adjustment, the human equivalent concentration (HEC) is calculated based on a NOAEL of 3 ppm using Equation 4-10 (EPA 1990b). This equation was used due to the observation that chloroform achieves "periodicity" within 10% of the exposure duration (see Table A-1 below). Using Equation 4-10, the calculation is:

$$\text{NOAEL}_{(\text{HEC})} = \text{NOAEL} \times [(\text{blood:air coeff})_{\text{mouse}} / (\text{blood:air coeff})_{\text{human}}]$$

given that the ratio of the blood:air partition coefficients are <1. In the case of chloroform, using the blood:air partition coefficients for the mouse is 21.3 and for the human is 7.34 (Corley et al. 1990), the ratio of mouse:human partition coefficients (21.3/7.34) is >1, therefore a default value of 1 is used to derive the  $\text{NOAEL}_{\text{HEC}}$ :

$$\text{NOAEL}_{\text{HEC}} = 3 \text{ ppm} \times 1$$

$$\text{NOAEL}_{\text{HEC}} = 3 \text{ ppm}$$

where:

$\text{NOAEL}_{[\text{HEC}]}$  = Human Equivalent Concentration of the NOAEL (no-observed-adverse effect level)

The MRL calculation is as follows:

$$\text{MRL} = \text{NOAEL}_{[\text{HEC}]} / \text{UF}$$

$$\text{MRL} = 3 \text{ ppm} / 30$$

$$\text{MRL} = 0.1 \text{ ppm}$$

Was a conversion used from intermittent to continuous exposure?

If so, explain: No.

Other additional studies or pertinent information that lend support to this MRL:

The Larson et al. (1994c) study is accompanied by a companion study performed by Mery et al. (1994), which examined the nasal lesions much more closely than this Larson study. The purpose of the Mery et al. study was to determine nasal cavity site-specific lesions and any cell induction/proliferation associated with varying concentrations of chloroform (0, 1, 3, 10, 30, 100, 300 ppm) inhaled by both rats and mice 6 hours a day for 7 days. Female B6C3F<sup>1</sup> mice and male Fischer 344 rats were used. Tissue abnormalities seen grossly, histopathologically, enzymatically (cytochrome P-450 levels), and in cell proliferation (BrdU labeling of cells in the S-phase) were reported for both rats and mice. The respiratory epithelium of the nasopharyngeal meatus exhibited an increase in the size of goblet cells at 100 and 300 ppm chloroform, in addition to an increase in both neutral and

## APPENDIX A

acidic mucopolysaccharides. Affected epithelium was up to twice the normal thickness. New bone formation within the nasal region was prominently seen at 10 ppm and above and followed a concentration response curve. At 1 ppm, only 1 animal showed mild bone enlargement of the first endoturbinates, with no changes seen at 3 ppm. At 10 ppm, minor enlargement was present in all animals. At 30 and 100 ppm, new osseous spicules were present at the beginning of the first endoturbinates, while at 300 ppm, the width of the new bone was almost doubled compared to controls receiving no chloroform, with lesions extending to involve up to 75% of the turbinate in all of the sites studied. Enzymatically, staining for P-450-2E1 was most prominent in the control animals in the cytoplasm of olfactory epithelial sustentacular cells and in the acinar cells of Bowman's glands, and more intense in the superficial cells than in the deep cells. In general, starting at about 3 ppm, increasing the chloroform concentration tended to decrease the amount of P-450 staining. Exposure to chloroform resulted in a dramatic increase in the number of S-phase nuclei. A clear proportional concentration-related effect was observed, with the proliferative response confined to activated periosteal cells, including both osteogenic (round) and preosteogenic (spindle) cells. The proximal and central regions of the first endoturbinates had the highest increase of cell proliferation, while the distal part had only a moderate response, with this response being statistically significant from controls at concentrations of greater than 10 ppm. Decreased body weight was observed at 300 ppm only (data not provided). In mice, decreased body weight was observed at 100 and 300 ppm (data not provided). The only treatment-related histologic change observed in female mice was a slight indication of new bone growth in the proximal part of the first endoturbinates in one mouse exposed to 300 ppm chloroform. The S-phase response was observed at chloroform concentration of 10 ppm and higher.

Using the Corley PBPK model for chloroform (Corley et al. 1990) in the Scop version (courtesy of Dr. Nancy Chiu, USEPA) to simulate the mouse exposure of chloroform by inhalation. This data is presented below:

**Table A-1. Corley PBPK Model for Chloroform to Simulate Mouse Exposure by Inhalation**

Time (hrs):	Blood Concentration (CA) (mg/L):
0.00	0.014
0.25	0.040
0.50	0.041
0.75	0.041
1.25	0.042
1.50	0.042
1.75	0.042
2.00	0.042
2.25	0.042
2.50	0.042
3.375	0.042
4.5	0.042
5.625	0.042
6.75	0.0006

Source: Corley et al. (1990) in the Scop version (courtesy of Dr. Nancy Chiu, USEPA).

## APPENDIX A

The data furnished by this model demonstrates that the arterial blood concentration (CA) of chloroform in the mouse exposed to 3 ppm of chloroform for 6 hours reached "periodicity" within 15 minutes following exposure. This data allowed the use of EPA (1990b) Equation 4-10 to derive the acute-duration inhalation MRL for chloroform exposure.

Agency Contact (Chemical Manager): Selene Chou

## APPENDIX A

**MINIMAL RISK LEVEL WORKSHEET**

Chemical name(s): Chloroform  
CAS number(s): 000067-66-3  
Date: March 19, 1997  
Profile status: Final  
Route:  Inhalation  Oral  
Duration:  Acute  Intermediate  Chronic  
Key to figure: 39  
Species: Human

MRL: 0.05  mg/kg/day  ppm  mg/m<sup>3</sup>

Reference: Phoon WH, Goh KT, Lee LT, et al. 1983. Toxic jaundice from occupational exposure to chloroform. Med J Malaysia 38:31-34.

Experimental design: The study describes outbreaks of toxic hepatitis in workers occupationally exposed to chloroform in two different factories. Mostly women were employed in both places.

Effects noted in study and corresponding doses: The workers in the first outbreak were exposed to concentrations up to 400 ppm chloroform in the workplace. No other chemical was involved. Blood chloroform levels in exposed workers ranged from 0.10 to 0.29 mg/100 mL. Workplace concentration levels of chloroform ranged from 14 to 50 ppm in the second outbreak. Vomiting and toxic hepatitis were noted to occur at an inhaled concentration of 14 ppm (less serious LOAEL). All affected workers were exposed to chloroform for less than six months. The patients exhibited anorexia, nausea, vomiting, and jaundice without fever. The subjects had originally been diagnosed with viral hepatitis, however the diagnosis of toxic hepatitis due to chloroform exposure was based upon epidemiological considerations.

Dose and end point used for MRL derivation:

NOAEL  LOAEL : 14 ppm for hepatic effects

Uncertainty factors (UF) used in MRL derivation: 100

1  3  10 (for use of a LOAEL)

1  3  10 (for human variability)

Modifying factor (MF) used in MRL derivation:

1  3  10 (for insufficient diagnostic data to determine the seriousness of hepatotoxic effects)

Was a conversion factor used from ppm in food or water to a mg/body weight dose?

If so, explain: No.

If an inhalation study in animals, list conversion factors used in determining human equivalent dose:

No factors were used to convert to a human equivalent dose, since the data obtained from this study was obtained from human exposures to chloroform.



## APPENDIX A

The MRL calculation is as follows:

$$\text{MRL} = \text{LOAEL} / (\text{UF} \times \text{MF})$$

$$\text{MRL} = 14 \text{ ppm} / (100 \times 3)$$

$$\text{MRL} = 0.05 \text{ ppm}$$

Was a conversion used from intermittent to continuous exposure?

If so, explain: No.

Other additional studies or pertinent information that lend support to this MRL:

The study by Bomski et al. (1967) noted similar finding in a group of 68 workers occupationally exposed to chloroform for 1–4 years in a pharmaceutical plant. Inhaled chloroform concentrations ranged from 0.01 to 1 mg/L. Other solvents were reported in the air in trace amounts. Hepatomegaly was found in 25% of chloroform-exposed workers. Toxic hepatitis was found in 5.6% of the liver enlargement cases. The workers were diagnosed as having hepatosplenomegaly, enhanced serum glutamic pyruvic transaminase [SGPT] and serum glutamic oxaloacetic transaminase [SGOT] activities, and hyper-gammaglobulinemia. Hepatosteatorsis (fatty liver) was detected in 20.6% of liver-enlargement cases. Chloroform-exposed workers had a higher frequency of jaundice over the years than the control group.

Agency Contact (Chemical Manager): Selene Chou

## APPENDIX A

**MINIMAL RISK LEVEL WORKSHEET**

Chemical name(s): Chloroform  
CAS number(s): 000067-66-3  
Date: March 19, 1997  
Profile status: Final  
Route:  Inhalation  Oral  
Duration:  Acute  Intermediate  Chronic  
Key to figure: 51  
Species: Human

MRL: 0.02  mg/kg/day  ppm  mg/m<sup>3</sup>

Reference: Bomski H, Sobolewska A, Strakowski A. 1967. [Toxic damage of the liver by chloroform in chemical industry workers.] Int Arch F Gewerbepathologie u. Gewerbehygiene 24:127-134 (German).

Experimental design: A group of 68 workers occupationally exposed to chloroform for 1–4 years in a pharmaceutical plant were examined. Doses of inhaled chloroform ranged from 2 to 205 ppm over a 1–4-year-period. Air concentrations of chloroform ranged from 0.01 mg/L to 1 mg/L. Other solvents were reported in the air in trace amounts.

Effects noted in study and corresponding doses: A systemic LOAEL (hepatomegaly) of 2 ppm was determined from the data presented in this study. Hepatomegaly was found in 25% of chloroform exposed workers. The results were compared with a group of unexposed controls, and a group of persons who had infectious hepatitis during the last 1–4 years. Toxic hepatitis was found in 5.6% of the liver enlargement cases (the workers were diagnosed as having hepatosplenomegaly, enhanced SGPT and SGOT activities, and hyper-gammaglobulinemia). Hepatosteatorosis (fatty liver) was detected in 20.6% of liver-enlargement cases. Functional tests were negative in most of the subjects; a biopsy was not performed in any case. Chloroform-exposed workers had a higher frequency of jaundice over the years than the control group. The authors speculated that a viral infection might have been promoted in the chloroform damaged liver.

Dose end point used for MRL derivation:

NOAEL  LOAEL: 2 ppm for hepatic effects

Uncertainty factors used in MRL derivation: 100

1  3  10 (for use of a LOAEL)

1  3  10 (for human variability)

Was a conversion factor used from ppm in food or water to a mg/body weight dose?

If so, explain: No.

If an inhalation study in animals, list conversion factors used in determining human equivalent dose:

No factors were used to convert to a human equivalent dose, since the data obtained from this study was obtained from human exposures to chloroform.

## APPENDIX A

The MRL calculation is as follows:

$$\text{MRL} = \text{LOAEL} / (\text{UF})$$

$$\text{MRL} = 2 \text{ ppm} / (100)$$

$$\text{MRL} = 0.02 \text{ ppm}$$

Was a conversion used from intermittent to continuous exposure?

If so, explain: No.

Other additional studies or pertinent information that lend support to this MRL:

Agency Contact (Chemical Manager): Selene Chou

## APPENDIX A

**MINIMAL RISK LEVEL WORKSHEET**

Chemical name(s): Chloroform  
CAS number(s): 000067-66-3  
Date: March 19, 1997  
Profile status: Final  
Route: [ ] Inhalation [X] Oral  
Duration: [X] Acute [ ] Intermediate [ ] Chronic  
Key to figure: 28  
Species: Mouse

MRL: 0.3 [X] mg/kg/day [ ] ppm [ ] mg/m<sup>3</sup>

Reference: Larson JL, Wolf DC, Butterworth BE. 1994b. Induced cytotoxicity and cell proliferation in the hepatocarcinogenicity of chloroform in female B6C3F<sub>1</sub> mice: comparison of administration by gavage in corn oil vs ad libitum in drinking water. *Fund Appl Toxicol* 22:90-102.

Experimental design:

This study was designed to identify a relationship between the magnitude and duration of chloroform-induced histopathologic and proliferative responses for female mice dosed with chloroform in the drinking water vs those dosed in corn oil via gavage. Authors placed 0, 60, 200, 400, 900, or 1,800 ppm of chloroform in drinking water; however, due to decreased water intake, the authors' calculation of consumed chloroform was 0, 16, 26, 53, 81, or 105 mg/kg/day.

Effects noted in study and corresponding doses:

In the 400, 900, and 1,800 ppm treatment groups, the livers had tinctorial changes characterized by pale cytoplasmic eosinophilic staining of centrilobular hepatocytes compared to the periportal hepatocytes and controls. Livers from mice treated with 200 ppm (26 mg/kg/day actual intake) chloroform or less failed to show significant histologic changes when compared to controls. Thus the dose of 26 mg/kg/day was considered the NOAEL for hepatic effects in these mice. Chloroform exposure did cause a slight dose dependent decrease in number of cells in S-phase in the kidneys, mainly in the cortex, while there was an increase in these type of cells in the outer medullary region. Decreased body weight was observed at the two highest doses. After 4 days treatment, serum clinical chemistry analyses were not different from controls in either liver alanine aminotransferase (ALT) or sorbitol dehydrogenase (SDH) at any dose.

Dose end point used for MRL derivation:

[X] NOAEL [ ] LOAEL: 26 mg/kg/day for hepatic effects in mice

## APPENDIX A

Uncertainty factors used in MRL derivation: 100

- 1  3  10 (for use of a LOAEL)  
 1  3  10 (for extrapolation from animals to humans)  
 1  3  10 (for human variability)

Was a conversion factor used from ppm in food or water to a mg/body weight dose?

If so, explain:

Conversion of the ppm concentration of chloroform in the drinking water to a mg/kg/day dose was provided by the authors of the paper.

The MRL calculation is as follows:

$$\text{MRL} = \text{NOAEL} / \text{UF}$$

$$\text{MRL} = 26 \text{ mg/kg/day} / 100$$

$$\text{MRL} = 0.3 \text{ mg/kg/day}$$

If an inhalation study in animals, list conversion factors used in determining human equivalent dose:

Was a conversion used from intermittent to continuous exposure?

If so, explain:

Other additional studies or pertinent information that lend support to this MRL:

Larson et al. (1995) also studied the dose response relationships for the induction of cytolethality and regenerative cell proliferation in male Fischer 344 rats given chloroform in corn oil by gavage or in the drinking water. Groups of 12 rats were administered oral doses of 0, 3, 10, 34, 90, and 180 mg/kg/day chloroform in corn oil by gavage for 4 or for 5 days a week for 3 weeks. BrdU was administered via an implanted osmotic pump to label cells in S-phase. Statistically significant decreases in body weight gains were observed in the 180 mg/kg/day dose group at 4 days and in the 90 and 180 mg/kg/day dose groups at 3 weeks. At 34 mg/kg/day, slight-to-mild centrilobular sinusoidal leukostasis was observed after 4 days of exposure. The livers of rats given 90 mg/kg/day for 4 days had a slight increase in centrilobular pallor and necrosis of hepatocytes surrounding the central vein; the remaining central and some mid-zonal hepatocytes were swollen and displayed a cytoplasmic granularity. After 3 weeks of exposure, livers of rats in the 34 or 90 mg/kg/day dose groups did not differ from controls. In the 180 mg/kg/day dose group, the livers of rats after 4 days had scattered individual cell necrosis throughout the central and midzonal regions. The cytoplasm of the centrilobular hepatocytes was pale eosinophilic and mildly vacuolated. In the 180 mg/kg/day dose group, after 3 weeks effects were similar to those seen at 4 days after exposure. Dose-dependent increases in both ALT and SDH were observed at 4 days in the 90 and 180 mg/kg/day dose groups and at 3 weeks in the 180 mg/kg/day dose group only. A dose-dependent increase in LI was seen in rat liver after 4 days of treatment with 90 and 180 mg/kg/day by gavage, but the LI remained elevated after 3 weeks of treatment only at the 180 mg/kg/day dose. At doses of 0, 60, 200, 400, 900, and 1,800 ppm for 4 days, no microscopic alterations were seen in the kidneys after 4 days of treatment. As a general observation, rats treated for 3 weeks with 200 ppm chloroform and greater had slightly increased numbers of focal areas of regenerating renal proximal tubular epithelium and cell proliferation than were

## APPENDIX A

noted in controls, but no clear dose response relationship was evident. However, the overall renal LI was not increased at any dose or time point. Similarly, only mild hepatocyte vacuolation was observed in rats given 900 or 1,800 ppm in water for 4 days and in rats given 1,800 ppm in water for 3 weeks. No increase in the hepatic LI was observed at any time point. When chloroform was administered in the drinking water at doses of 0, 60, 200, 400, 900, and 1,800 ppm for 3 weeks, no microscopic alterations were seen in the kidneys after 4 days of treatment. As a general observation, rats treated for 3 weeks with 200 ppm chloroform and greater had slightly increased numbers of focal areas of regenerating renal proximal tubular epithelium and cell proliferation than were noted in controls, but no clear dose response relationship was evident. However, the overall renal LI was not increased at any dose or time point. Similarly, only mild hepatocyte vacuolation was observed in rats given 900 or 1,800 ppm in water for 4 days and in rats given 1,800 ppm in water for 3 weeks. No increase in the hepatic LI was observed at any time point. The authors noted that these data indicated more severe hepatic and renal toxicity when chloroform is administered by gavage than in the drinking water.

Agency Contact (Chemical Manager): Selene Chou

## APPENDIX A

**MINIMAL RISK LEVEL WORKSHEET**

Chemical name(s): Chloroform  
CAS number(s): 000067-66-3  
Date: March 19, 1997  
Profile status: Final  
Route:  Inhalation  Oral  
Duration:  Acute  Intermediate  Chronic  
Key to figure: 68  
Species: Dog

MRL: 0.1  mg/kg/day  ppm  mg/m<sup>3</sup>

Reference: Heywood R, Sortwell RJ, Noel PRB, et al. 1979. Safety evaluation of toothpaste containing chloroform. III. Long-term study in beagle dogs. J Environ Pathol Toxicol 2:835-851.

Experimental design: An intermediate oral exposure MRL of 0.1 mg/kg/day was derived using the study by Heywood et al. (1979). The study was 7.5 years in duration in which 8 male and 8 female Beagle dogs were exposed to chloroform in toothpaste capsules, with doses of 0, 15, and 30 mg/kg/day, 6 days a week for 6 weeks. Clinical chemistry parameters were monitored at 6 and 13 weeks of exposure and thereafter at intervals of 8–32 weeks.

Effects noted in study and corresponding doses: Serum glutamic pyruvic transaminase (SGPT) activity was significantly increased ( $p < 0.05$ ) in the 30 mg/kg/day group beginning at 6 weeks and at every interval thereafter. SGPT activity was not increased in the 15 mg/kg/day group until week 130. Thus, 15 mg/kg/day is the NOAEL for intermediate duration exposure.

Dose end point used for MRL derivation:

NOAEL  LOAEL : 15 mg/kg/day for hepatic effects

Uncertainty factors used in MRL derivation: 100

1  3  10 (for extrapolation from animals to humans)  
 1  3  10 (for human variability)

Was a conversion factor used from ppm in food or water to a mg/body weight dose?  
If so, explain:

No.

If an inhalation study in animals, list conversion factors used in determining human equivalent dose:

Was a conversion used from intermittent to continuous exposure?  
If so, explain:

(15 mg/kg/day) x 6/7 days = 12.9 mg/kg/day

## APPENDIX A

The MRL calculation is as follows:

$$\text{MRL} = \text{NOAEL}_{[\text{ADJ}]} / \text{UF}$$

$$\text{MRL} = 12.9 \text{ mg/kg/day} / 100$$

$$\text{MRL} = 0.1 \text{ mg/kg/day}$$

Other additional studies or pertinent information that lend support to this MRL:

Liver effects in animals have been reported in numerous oral studies of intermediate duration. Fatty changes, necrosis, increased liver weight, and hyperplasia have been observed in rats exposed to  $\geq 150$  mg/kg/day chloroform in drinking water for 90 days (Palmer et al. 1979). An increased incidence of sporadic, mild, reversible liver changes occurred in mice exposed to chloroform in drinking water at doses of 0.3–114 mg/kg/day for 90 days, but the incidences were not significantly higher than the incidences in controls (Chu et al. 1982a). Fatty and hydropic changes, necrosis, and cirrhosis were observed in mice treated by gavage with  $\geq 50$  mg/kg/day chloroform in oil for 90 days (Bull et al. 1986; Munson et al. 1982) or at 86 mg/kg/day in drinking water for 1 year (Klaunig et al. 1986). In contrast, centrilobular fatty changes observed in mice at 64 mg/kg/day chloroform in drinking water for 90 days appeared to be reversible (Jorgenson and Rushbrook 1980), and no liver effects were found in mice treated with  $\geq 50$  mg/kg/day in aqueous vehicles (Bull et al. 1986). In addition, hepatocellular degeneration was induced in F<sub>1</sub> females in a 2-generation study in which mice were treated by gavage with 41 mg/kg/day chloroform in oil (Gulati et al. 1988).

Agency Contact (Chemical Manager): Selene Chou



## APPENDIX A

**MINIMAL RISK LEVEL WORKSHEET**

Chemical name(s): Chloroform  
CAS number(s): 000067-66-3  
Date: March 19, 1997  
Profile status: Final  
Route:  Inhalation  Oral  
Duration:  Acute  Intermediate  Chronic  
Key to figure: 89  
Species: Dog

MRL: 0.01  mg/kg/day  ppm  mg/m<sup>3</sup>

Reference: Heywood R, Sortwell RJ, Noel PRB, et al. 1979. Safety evaluation of toothpaste containing chloroform. III. Long-term study in beagle dogs. J Environ Pathol Toxicol 2:835-851.

Experimental design: Eight male and 8 female Beagle dogs were exposed to chloroform in toothpaste capsules. Doses used were 0, 15, and 30 mg/kg/day, 6 days a week for 7.5 years. Clinical chemistry parameters were monitored at 6 and 13 weeks of exposure and thereafter at intervals of 8–32 weeks for 7.5 years.

Effects noted in study and corresponding doses: SGPT activity was significantly increased ( $p < 0.05$ ) in the 30 mg/kg/day group beginning at 6 weeks and at every interval thereafter. SGPT activity was not increased in the 15 mg/kg/day group until week 130. No treatment-related body weight changes were observed in chloroform exposed dogs. No hematological changes were found. Increased SGPT levels, and less distinct elevation of SGOT and SAP seemed to be dose-related. However, the SGPT levels tended to return to normal during the recovery period. Bromsulphalein retention test was performed during the sixth year of the study; no treatment-related abnormality was found. No organ weight changes were found in the exposed groups. No remarkable histopathological differences were observed in dogs regarding the cardiovascular system. Fatty cysts were observed in the liver in all groups; however, in females the incidence seemed to be dose-related (3 of 12, 5 of 8, 7 of 8). Fat deposition in renal glomeruli was reportedly higher in the 30 mg/kg/day chloroform group.

Dose end point used for MRL derivation:

NOAEL  LOAEL: 15 mg/kg/day for hepatic effects

Uncertainty factors used in MRL derivation: 1000

1  3  10 (for use of a LOAEL)  
 1  3  10 (for extrapolation from animals to humans)  
 1  3  10 (for human variability)

Was a conversion factor used from ppm in food or water to a mg/body weight dose?

If so, explain: No.

If an inhalation study in animals, list conversion factors used in determining human equivalent dose:

## APPENDIX A

Was a conversion used from intermittent to continuous exposure?

If so, explain:

$(15 \text{ mg/kg/day}) \times 6/7 \text{ days} = 12.9 \text{ mg/kg/day}$ .

The MRL calculation is as follows:

$$\text{MRL} = \text{LOAEL}_{[\text{ADJ}]} / \text{UF}$$

$$\text{MRL} = 12.9 \text{ mg/kg/day} / 1000$$

$$\text{MRL} = 0.01 \text{ mg/kg/day}$$

Other additional studies or pertinent information that lend support to this MRL:

Numerous chronic-duration oral studies examined hepatic and renal end points as well as neurological and cancer effects. Serious effects occurred at higher doses; 15 mg/kg/day was the lowest dose used in available animals studies. A NOAEL of 2.46 mg/kg/day for liver and kidney effects (SGPT, SGOT, BUN and SAP) was found in humans who used a dentifrice containing 0.34% or a mouthwash containing 0.43% chloroform for 1–5 years (DeSalva et al. 1974).

Agency Contact (Chemical Manager): Selene Chou



## APPENDIX B

### USER'S GUIDE

#### Chapter 1

##### Public Health Statement

This chapter of the profile is a health effects summary written in non-technical language. Its intended audience is the general public especially people living in the vicinity of a hazardous waste site or chemical release. If the Public Health Statement were removed from the rest of the document, it would still communicate to the lay public essential information about the chemical.

The major headings in the Public Health Statement are useful to find specific topics of concern. The topics are written in a question and answer format. The answer to each question includes a sentence that will direct the reader to chapters in the profile that will provide more information on the given topic.

#### Chapter 2

##### Tables and Figures for Levels of Significant Exposure (LSE)

Tables (2- 1, 2-2, and 2-3) and figures (2- 1 and 2-2) are used to summarize health effects and illustrate graphically levels of exposure associated with those effects. These levels cover health effects observed at increasing dose concentrations and durations, differences in response by species, minimal risk levels (MRLs) to humans for noncancer endpoints, and EPA's estimated range associated with an upper-bound individual lifetime cancer risk of 1 in 10,000 to 1 in 10,000,000. Use the LSE tables and figures for a quick review of the health effects and to locate data for a specific exposure scenario. The LSE tables and figures should always be used in conjunction with the text. All entries in these tables and figures represent studies that provide reliable, quantitative estimates of No-Observed-Adverse- Effect Levels (NOAELs), Lowest-Observed- Adverse-Effect Levels (LOAELs), or Cancer Effect Levels (CELs).

The legends presented below demonstrate the application of these tables and figures. Representative examples of LSE Table 2-1 and Figure 2-1 are shown. The numbers in the left column of the legends correspond to the numbers in the example table and figure.

#### LEGEND

##### See LSE Table 2-1

- (1) Route of Exposure One of the first considerations when reviewing the toxicity of a substance using these tables and figures should be the relevant and appropriate route of exposure. When sufficient data exists, three LSE tables and two LSE figures are presented in the document. The three LSE tables present data on the three principal routes of exposure, i.e., inhalation, oral, and dermal (LSE Table 2- 1, 2-2, and 2-3, respectively). LSE figures are limited to the inhalation (LSE Figure 2- 1) and oral (LSE Figure 2-2) routes. Not all substances will have data on each route of exposure and will not therefore have all five of the tables and figures.
- (2) Exposure Period Three exposure periods - acute (less than 15 days), intermediate (15-364 days), and chronic (365 days or more) are presented within each relevant route of exposure. In this example, an inhalation study of intermediate exposure duration is reported. For quick reference to health effects

## APPENDIX B

occurring from a known length of exposure, locate the applicable exposure period within the LSE table and figure.

- (3) Health Effect The major categories of health effects included in LSE tables and figures are death, systemic, immunological, neurological, developmental, reproductive, and cancer. NOAELs and LOAELs can be reported in the tables and figures for all effects but cancer. Systemic effects are further defined in the “System” column of the LSE table (see key number 18).
- (4) Key to Figure Each key number in the LSE table links study information to one or more data points using the same key number in the corresponding LSE figure. In this example, the study represented by key number 18 has been used to derive a NOAEL and a Less Serious LOAEL (also see the 2 “18r” data points in Figure 2-1).
- (5) Species The test species, whether animal or human, are identified in this column. Section 2.4, “Relevance to Public Health,” covers the relevance of animal data to human toxicity and Section 2.3, “Toxicokinetics,” contains any available information on comparative toxicokinetics. Although NOAELs and LOAELs are species specific, the levels are extrapolated to equivalent human doses to derive an MRL.
- (6) Exposure Frequency/Duration The duration of the study and the weekly and daily exposure regimen are provided in this column. This permits comparison of NOAELs and LOAELs from different studies. In this case (key number 18), rats were exposed to toxaphene via inhalation for 6 hours per day, 5 days per week, for 3 weeks. For a more complete review of the dosing regimen refer to the appropriate sections of the text or the original reference paper, i.e., Nitschke et al. 1981.
- (7) System This column further defines the systemic effects. These systems include: respiratory, cardiovascular, gastrointestinal, hematological, musculoskeletal, hepatic, renal, and dermal/ocular. “Other” refers to any systemic effect (e.g., a decrease in body weight) not covered in these systems. In the example of key number 18, 1 systemic effect (respiratory) was investigated.
- (8) NOAEL A No-Observed-Adverse-Effect Level (NOAEL) is the highest exposure level at which no harmful effects were seen in the organ system studied. Key number 18 reports a NOAEL of 3 ppm for the respiratory system which was used to derive an intermediate exposure, inhalation MRL of 0.0005 ppm (see footnote “b”).
- (9) LOAEL A Lowest-Observed-Adverse-Effect Level (LOAEL) is the lowest dose used in the study that caused a harmful health effect. LOAELs have been classified into “Less Serious” and “Serious” effects. These distinctions help readers identify the levels of exposure at which adverse health effects first appear and the gradation of effects with increasing dose. A brief description of the specific endpoint used to quantify the adverse effect accompanies the LOAEL. The respiratory effect reported in key number 18 (hyperplasia) is a Less serious LOAEL of 10 ppm. MRLs are not derived from Serious LOAELs.
- (10) Reference The complete reference citation is given in chapter 8 of the profile.
- (11) CEL A Cancer Effect Level (CEL) is the lowest exposure level associated with the onset of carcinogenesis in experimental or epidemiologic studies. CELs are always considered serious effects. The LSE tables and figures do not contain NOAELs for cancer, but the text may report doses not causing measurable cancer increases.

## APPENDIX B

- (12) Footnotes Explanations of abbreviations or reference notes for data in the LSE tables are found in the footnotes. Footnote “b” indicates the NOAEL of 3 ppm in key number 18 was used to derive an MRL of 0.0005 ppm.

**LEGEND****See Figure 2-1**

LSE figures graphically illustrate the data presented in the corresponding LSE tables. Figures help the reader quickly compare health effects according to exposure concentrations for particular exposure periods.

- (13) Exposure Period The same exposure periods appear as in the LSE table. In this example, health effects observed within the intermediate and chronic exposure periods are illustrated.
- (14) Health Effect These are the categories of health effects for which reliable quantitative data exists. The same health effects appear in the LSE table.
- (15) Levels of Exposure concentrations or doses for each health effect in the LSE tables are graphically displayed in the LSE figures. Exposure concentration or dose is measured on the log scale “y” axis. Inhalation exposure is reported in mg/m<sup>3</sup> or ppm and oral exposure is reported in mg/kg/day.
- (16) NOAEL In this example, 18r NOAEL is the critical endpoint for which an intermediate inhalation exposure MRL is based. As you can see from the LSE figure key, the open-circle symbol indicates to a NOAEL for the test species-rat. The key number 18 corresponds to the entry in the LSE table. The dashed descending arrow indicates the extrapolation from the exposure level of 3 ppm (see entry 18 in the Table) to the MRL of 0.0005 ppm (see footnote “b” in the LSE table).
- (17) CEL Key number 38r is 1 of 3 studies for which Cancer Effect Levels were derived. The diamond symbol refers to a Cancer Effect Level for the test species-mouse. The number 38 corresponds to the entry in the LSE table.
- (18) Estimated Upper-Bound Human Cancer Risk Levels This is the range associated with the upper-bound for lifetime cancer risk of 1 in 10,000 to 1 in 10,000,000. These risk levels are derived from the EPA’s Human Health Assessment Group’s upper-bound estimates of the slope of the cancer dose response curve at low dose levels (q<sub>1</sub> \*).
- (19) Key to LSE Figure The Key explains the abbreviations and symbols used in the figure.

**SAMPLE**

1 →

**TABLE 2-1. Levels of Significant Exposure to [Chemical x] – Inhalation**

Key to figure <sup>a</sup>	Species	Exposure frequency/ duration	System	NOAEL (ppm)	LOAEL (effect)		Reference
					Less serious (ppm)	Serious (ppm)	
<b>INTERMEDIATE EXPOSURE</b>							
2 →	5	6	7	8	9		10
3 →	Systemic	↓	↓	↓	↓		↓
4 →	18	Rat	13 wk 5d/wk 6hr/d	Resp	3 <sup>b</sup>	10 (hyperplasia)	Nitschke et al. 1981
<hr style="border-top: 1px dashed black;"/>							
<b>CHRONIC EXPOSURE</b>							
						11	
	Cancer					↓	
38	Rat	18 mo 5d/wk 7hr/d				20	(CEL, multiple organs) Wong et al. 1982
39	Rat	89–104 wk 5d/wk 6hr/d				10	(CEL, lung tumors, nasal tumors) NTP 1982
40	Mouse	79–103 wk 5d/wk 6hr/d				10	(CEL, lung tumors, hemangiosarcomas) NTP 1982

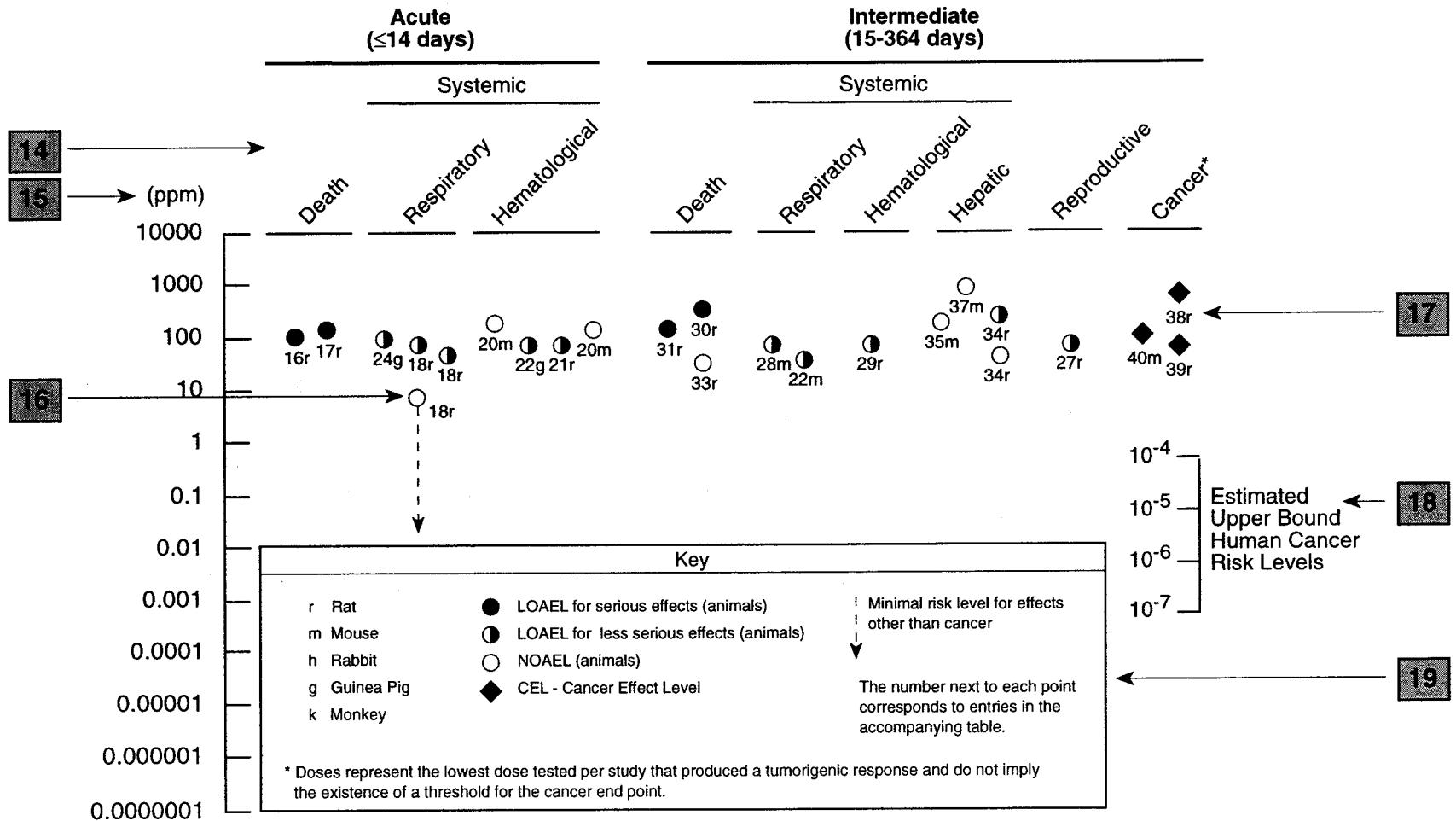
<sup>a</sup> The number corresponds to entries in Figure 2-1.

12 →

<sup>b</sup> Used to derive an intermediate inhalation Minimal Risk Level (MRL) of  $5 \times 10^{-3}$  ppm; dose adjusted for intermittent exposure and divided by an uncertainty factor of 100 (10 for extrapolation from animal to humans, 10 for human variability).

**SAMPLE**

**13** → **Figure 2-1. Levels of Significant Exposure to [Chemical X] – Inhalation**





## APPENDIX B

**Chapter 2 (Section 2.4)****Relevance to Public Health**

The Relevance to Public Health section provides a health effects summary based on evaluations of existing toxicologic, epidemiologic, and toxicokinetic information. This summary is designed to present interpretive, weight-of-evidence discussions for human health endpoints by addressing the following questions.

1. What effects are known to occur in humans?
2. What effects observed in animals are likely to be of concern to humans?
3. What exposure conditions are likely to be of concern to humans, especially around hazardous waste sites?

The section covers endpoints in the same order they appear within the Discussion of Health Effects by Route of Exposure section, by route (inhalation, oral, dermal) and within route by effect. Human data are presented first, then animal data. Both are organized by duration (acute, intermediate, chronic). *In vitro* data and data from parenteral routes (intramuscular, intravenous, subcutaneous, etc.) are also considered in this section. If data are located in the scientific literature, a table of genotoxicity information is included.

The carcinogenic potential of the profiled substance is qualitatively evaluated, when appropriate, using existing toxicokinetic, genotoxic, and carcinogenic data. ATSDR does not currently assess cancer potency or perform cancer risk assessments. Minimal risk levels (MRLs) for noncancer endpoints (if derived) and the endpoints from which they were derived are indicated and discussed.

Limitations to existing scientific literature that prevent a satisfactory evaluation of the relevance to public health are identified in the Data Needs section.

**Interpretation of Minimal Risk Levels**

Where sufficient toxicologic information is available, we have derived minimal risk levels (MRLs) for inhalation and oral routes of entry at each duration of exposure (acute, intermediate, and chronic). These MRLs are not meant to support regulatory action; but to acquaint health professionals with exposure levels at which adverse health effects are not expected to occur in humans. They should help physicians and public health officials determine the safety of a community living near a chemical emission, given the concentration of a contaminant in air or the estimated daily dose in water. MRLs are based largely on toxicological studies in animals and on reports of human occupational exposure.

MRL users should be familiar with the toxicologic information on which the number is based. Chapter 2.4, "Relevance to Public Health," contains basic information known about the substance. Other sections such as 2.6, "Interactions with Other Substances," and 2.7, "Populations that are Unusually Susceptible" provide important supplemental information.

MRL users should also understand the MRL derivation methodology. MRLs are derived using a modified version of the risk assessment methodology the Environmental Protection Agency (EPA) provides (Barnes and Dourson 1988) to determine reference doses for lifetime exposure (RfDs).

## APPENDIX B

To derive an MRL, ATSDR generally selects the most sensitive endpoint which, in its best judgement, represents the most sensitive human health effect for a given exposure route and duration. ATSDR cannot make this judgement or derive an MRL unless information (quantitative or qualitative) is available for all potential systemic, neurological, and developmental effects. If this information and reliable quantitative data on the chosen endpoint are available, ATSDR derives an MRL using the most sensitive species (when information from multiple species is available) with the highest NOAEL that does not exceed any adverse effect levels. When a NOAEL is not available, a lowest-observed-adverse-effect level (LOAEL) can be used to derive an MRL, and an uncertainty factor (UF) of 10 must be employed. Additional uncertainty factors of 10 must be used both for human variability to protect sensitive subpopulations (people who are most susceptible to the health effects caused by the substance) and for interspecies variability (extrapolation from animals to humans). In deriving an MRL, these individual uncertainty factors are multiplied together. The product is then divided into the inhalation concentration or oral dosage selected from the study. Uncertainty factors used in developing a substance-specific MRL are provided in the footnotes of the LSE Tables.



## APPENDIX C

## ACRONYMS, ABBREVIATIONS, AND SYMBOLS

ACGIH	American Conference of Governmental Industrial Hygienists
ADME	Absorption, Distribution, Metabolism, and Excretion
atm	atmosphere
ATSDR	Agency for Toxic Substances and Disease Registry
BCF	bioconcentration factor
BSC	Board of Scientific Counselors
C	Centigrade
CDC	Centers for Disease Control
CEL	Cancer Effect Level
CERCLA	Comprehensive Environmental Response, Compensation, and Liability Act
CFR	Code of Federal Regulations
CLP	Contract Laboratory Program
cm	centimeter
CNS	central nervous system
d	day
DHEW	Department of Health, Education, and Welfare
DHHS	Department of Health and Human Services
DOL	Department of Labor
ECG	electrocardiogram
EEG	electroencephalogram
EPA	Environmental Protection Agency
EKG	see ECG
F	Fahrenheit
F <sub>1</sub>	first filial generation
FAO	Food and Agricultural Organization of the United Nations
FEMA	Federal Emergency Management Agency
FIFRA	Federal Insecticide, Fungicide, and Rodenticide Act
fpm	feet per minute
ft	foot
FR	<i>Federal Register</i>
g	gram
GC	gas chromatography
gen	generation
HPLC	high-performance liquid chromatography
hr	hour
IDLH	Immediately Dangerous to Life and Health
IARC	International Agency for Research on Cancer
ILO	International Labor Organization
in	inch
K <sub>d</sub>	adsorption ratio
kg	kilogram
kkg	metric ton
K <sub>oc</sub>	organic carbon partition coefficient
K <sub>ow</sub>	octanol-water partition coefficient

## APPENDIX C

L	liter
LC	liquid chromatography
LC <sub>Lo</sub>	lethal concentration, low
LC <sub>50</sub>	lethal concentration, 50% kill
LD <sub>Lo</sub>	lethal dose, low
LD <sub>50</sub>	lethal dose, 50% kill
LOAEL	lowest-observed-adverse-effect level
LSE	Levels of Significant Exposure
m	meter
mg	milligram
min	minute
mL	milliliter
mm	millimeter
mm Hg	millimeters of mercury
mmol	millimole
mo	month
mppcf	millions of particles per cubic foot
MRL	Minimal Risk Level
MS	mass spectrometry
NIEHS	National Institute of Environmental Health Sciences
NIOSH	National Institute for Occupational Safety and Health
NIOSHTIC	NIOSH's Computerized Information Retrieval System
ng	nanogram
nm	nanometer
NHANES	National Health and Nutrition Examination Survey
nmol	nanomole
NOAEL	no-observed-adverse-effect level
NOES	National Occupational Exposure Survey
NOHS	National Occupational Hazard Survey
NPL	National Priorities List
NRC	National Research Council
NTIS	National Technical Information Service
NTP	National Toxicology Program
OSHA	Occupational Safety and Health Administration
PEL	permissible exposure limit
pg	picogram
pmol	picomole
PHS	Public Health Service
PMR	proportionate mortality ratio
ppb	parts per billion
ppm	parts per million
ppt	parts per trillion
REL	recommended exposure limit
RfD	Reference Dose
RTECS	Registry of Toxic Effects of Chemical Substances
sec	second
SCE	sister chromatid exchange
SIC	Standard Industrial Classification
SMR	standard mortality ratio

## APPENDIX C

STEL	short term exposure limit
STORET	STORAGE and RETRIEVAL
TLV	threshold limit value
TSCA	Toxic Substances Control Act
TRI	Toxics Release Inventory
TWA	time-weighted average
U.S.	United States
UF	uncertainty factor
yr	year
WHO	World Health Organization
wk	week
>	greater than
≥	greater than or equal to
=	equal to
<	less than
≤	less than or equal to
%	percent
α	alpha
β	beta
δ	delta
γ	gamma
μm	micrometer
μg	microgram



