



Uploaded to VFC Website

▶▶▶ July 2013 ◀◀◀

This Document has been provided to you courtesy of Veterans-For-Change!

Feel free to pass to any veteran who might be able to use this information!

For thousands more files like this and hundreds of links to useful information, and hundreds of "Frequently Asked Questions, please go to:

[Veterans-For-Change](http://www.veteransforchange.org)

*Veterans-For-Change is a 501(c)(3) Non-Profit Corporation
Tax ID #27-3820181*

If Veteran's don't help Veteran's, who will?

We appreciate all donations to continue to provide information and services to Veterans and their families.

https://www.paypal.com/cgi-bin/webscr?cmd=_s-xclick&hosted_button_id=WGT2M5UTB9A78

Note:

VFC is not liable for source information in this document, it is merely provided as a courtesy to our members.



TOXICOLOGICAL PROFILE FOR SELENIUM

U.S. DEPARTMENT OF HEALTH AND HUMAN SERVICES
Public Health Service
Agency for Toxic Substances and Disease Registry

September 2003

DISCLAIMER

The use of company or product name(s) is for identification only and does not imply endorsement by the Agency for Toxic Substances and Disease Registry.

UPDATE STATEMENT

A Toxicological Profile for selenium, Draft for Public Comment was released in September, 2001. This edition supersedes any previously released draft or final profile.

Toxicological profiles are revised and republished as necessary, but no less than once every three years. For information regarding the update status of previously released profiles, contact ATSDR at:

Agency for Toxic Substances and Disease Registry
Division of Toxicology/Toxicology Information Branch
1600 Clifton Road NE,
Mailstop E-29
Atlanta, Georgia 30333

FOREWORD

This toxicological profile is prepared in accordance with guidelines* developed by the Agency for Toxic Substances and Disease Registry (ATSDR) and the Environmental Protection Agency (EPA). The original guidelines were published in the *Federal Register* on April 17, 1987. Each profile will be revised and republished as necessary.

The ATSDR toxicological profile succinctly characterizes the toxicologic and adverse health effects information for the hazardous substance described therein. Each peer-reviewed profile identifies and reviews the key literature that describes a hazardous substance's toxicologic properties. Other pertinent literature is also presented, but is described in less detail than the key studies. The profile is not intended to be an exhaustive document; however, more comprehensive sources of specialty information are referenced.

The focus of the profiles is on health and toxicologic information; therefore, each toxicological profile begins with a public health statement that describes, in nontechnical language, a substance's relevant toxicological properties. Following the public health statement is information concerning levels of significant human exposure and, where known, significant health effects. The adequacy of information to determine a substance's health effects is described in a health effects summary. Data needs that are of significance to protection of public health are identified by ATSDR and EPA.

Each profile includes the following:

- (A) The examination, summary, and interpretation of available toxicologic information and epidemiologic evaluations on a hazardous substance to ascertain the levels of significant human exposure for the substance and the associated acute, subacute, and chronic health effects;
- (B) A determination of whether adequate information on the health effects of each substance is available or in the process of development to determine levels of exposure that present a significant risk to human health of acute, subacute, and chronic health effects; and
- (C) Where appropriate, identification of toxicologic testing needed to identify the types or levels of exposure that may present significant risk of adverse health effects in humans.

The principal audiences for the toxicological profiles are health professionals at the Federal, State, and local levels; interested private sector organizations and groups; and members of the public.

This profile reflects ATSDR's assessment of all relevant toxicologic testing and information that has been peer-reviewed. Staff of the Centers for Disease Control and Prevention and other Federal scientists have also reviewed the profile. In addition, this profile has been peer-reviewed by a nongovernmental panel and was made available for public review. Final responsibility for the contents and views expressed in this toxicological profile resides with ATSDR.

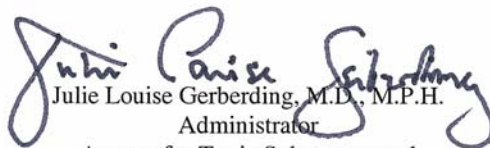
Julie Louise Gerberding, M.D., M.P.H.
Administrator
Agency for Toxic Substances and
Disease Registry

*Legislative Background

The toxicological profiles are developed in response to the Superfund Amendments and Reauthorization Act (SARA) of 1986 (Public Law 99-499) which amended the Comprehensive Environmental Response, Compensation, and Liability Act of 1980 (CERCLA or Superfund). This public law directed ATSDR to prepare toxicological profiles for hazardous substances most commonly found at facilities on the CERCLA National Priorities List and that pose the most significant potential threat to human health, as determined by ATSDR and the EPA. The availability of the revised priority list of 275 hazardous substances was announced in the *Federal Register* on October 25, 2001 (66 FR 54014). For prior versions of the list of substances, see *Federal Register* notices dated April 17, 1987 (52 FR 12866); October 20, 1988 (53 FR 41280); October 26, 1989 (54 FR 43619); October 17, 1990 (55 FR 42067); October 17, 1991 (56 FR 52166); October 28, 1992 (57 FR 48801); February 28, 1994 (59 FR 9486); April 29, 1996 (61 FR 18744); November 17, 1997 (62 FR 61332); and October 21, 1999 (64 FR 56792). Section 104(i)(3) of CERCLA, as amended, directs the Administrator of ATSDR to prepare a toxicological profile for each substance on the list.

QUICK REFERENCE FOR HEALTH CARE PROVIDERS

Toxicological Profiles are a unique compilation of toxicological information on a given hazardous substance. Each profile reflects a comprehensive and extensive evaluation, summary, and interpretation of available toxicologic and epidemiologic information on a substance. Health care providers treating patients potentially exposed to hazardous substances will find the following information helpful for fast answers to often-asked questions.

Primary Chapters/Sections of Interest

Chapter 1: Public Health Statement: The Public Health Statement can be a useful tool for educating patients about possible exposure to a hazardous substance. It explains a substance's relevant toxicologic properties in a nontechnical, question-and-answer format, and it includes a review of the general health effects observed following exposure.

Chapter 2: Relevance to Public Health: The Relevance to Public Health Section evaluates, interprets, and assesses the significance of toxicity data to human health.

Chapter 3: Health Effects: Specific health effects of a given hazardous compound are reported by *type of health effect* (death, systemic, immunologic, reproductive), by *route of exposure*, and by *length of exposure* (acute, intermediate, and chronic). In addition, both human and animal studies are reported in this section.

NOTE: Not all health effects reported in this section are necessarily observed in the clinical setting. Please refer to the Public Health Statement to identify general health effects observed following exposure.

Pediatrics: Four new sections have been added to each Toxicological Profile to address child health issues:

- Section 1.6** **How Can (Chemical X) Affect Children?**
- Section 1.7** **How Can Families Reduce the Risk of Exposure to (Chemical X)?**
- Section 3.7** **Children's Susceptibility**
- Section 6.6** **Exposures of Children**

Other Sections of Interest:

- Section 3.8** **Biomarkers of Exposure and Effect**
 - Section 3.11** **Methods for Reducing Toxic Effects**
-

ATSDR Information Center

Phone: 1-888-42-ATSDR or (404) 498-0110 **Fax:** (404) 498-0093
E-mail: atsdric@cdc.gov **Internet:** <http://www.atsdr.cdc.gov>

The following additional material can be ordered through the ATSDR Information Center:

Case Studies in Environmental Medicine: Taking an Exposure History—The importance of taking an exposure history and how to conduct one are described, and an example of a thorough exposure history is provided. Other case studies of interest include *Reproductive and Developmental Hazards*; *Skin Lesions and Environmental Exposures*; *Cholinesterase-Inhibiting Pesticide Toxicity*; and numerous chemical-specific case studies.

Managing Hazardous Materials Incidents is a three-volume set of recommendations for on-scene (prehospital) and hospital medical management of patients exposed during a hazardous materials incident. Volumes I and II are planning guides to assist first responders and hospital emergency department personnel in planning for incidents that involve hazardous materials. Volume III—*Medical Management Guidelines for Acute Chemical Exposures*—is a guide for health care professionals treating patients exposed to hazardous materials.

Fact Sheets (ToxFAQs) provide answers to frequently asked questions about toxic substances.

Other Agencies and Organizations

The National Center for Environmental Health (NCEH) focuses on preventing or controlling disease, injury, and disability related to the interactions between people and their environment outside the workplace. *Contact:* NCEH, Mailstop F-29, 4770 Buford Highway, NE, Atlanta, GA 30341-3724 • Phone: 770-488-7000 • FAX: 770-488-7015.

The National Institute for Occupational Safety and Health (NIOSH) conducts research on occupational diseases and injuries, responds to requests for assistance by investigating problems of health and safety in the workplace, recommends standards to the Occupational Safety and Health Administration (OSHA) and the Mine Safety and Health Administration (MSHA), and trains professionals in occupational safety and health. *Contact:* NIOSH, 200 Independence Avenue, SW, Washington, DC 20201 • Phone: 800-356-4674 or NIOSH Technical Information Branch, Robert A. Taft Laboratory, Mailstop C-19, 4676 Columbia Parkway, Cincinnati, OH 45226-1998 • Phone: 800-35-NIOSH.

The National Institute of Environmental Health Sciences (NIEHS) is the principal federal agency for biomedical research on the effects of chemical, physical, and biologic environmental agents on human health and well-being. *Contact:* NIEHS, PO Box 12233, 104 T.W. Alexander Drive, Research Triangle Park, NC 27709 • Phone: 919-541-3212.

Referrals

The Association of Occupational and Environmental Clinics (AOEC) has developed a network of clinics in the United States to provide expertise in occupational and environmental issues. *Contact:* AOEC, 1010 Vermont Avenue, NW, #513, Washington, DC 20005 • Phone: 202-347-4976 • FAX: 202-347-4950 • e-mail: AOEC@AOEC.ORG • Web Page: <http://www.aoec.org/>.

The American College of Occupational and Environmental Medicine (ACOEM) is an association of physicians and other health care providers specializing in the field of occupational and environmental medicine. *Contact:* ACOEM, 55 West Seegers Road, Arlington Heights, IL 60005 • Phone: 847-818-1800 • FAX: 847-818-9266.

CONTRIBUTORS

CHEMICAL MANAGER(S)/AUTHOR(S):

John Risher, Ph.D.
ATSDR, Division of Toxicology, Atlanta, GA

A. Rosa McDonald, Ph.D.
Mario J. Citra, Ph.D.
Stephen Bosch, B.S.
Richard J. Amata, M.S.
Syracuse Research Corporation, North Syracuse, NY

THE PROFILE HAS UNDERGONE THE FOLLOWING ATSDR INTERNAL REVIEWS:

1. Health Effects Review. The Health Effects Review Committee examines the health effects chapter of each profile for consistency and accuracy in interpreting health effects and classifying end points.
2. Minimal Risk Level Review. The Minimal Risk Level Workgroup considers issues relevant to substance-specific minimal risk levels (MRLs), reviews the health effects database of each profile, and makes recommendations for derivation of MRLs.
3. Data Needs Review. The Research Implementation Branch reviews data needs sections to assure consistency across profiles and adherence to instructions in the Guidance.

PEER REVIEW

A peer review panel was assembled for selenium. The panel consisted of the following members:

1. Orville Levander, Ph.D., Silver Springs, Maryland
2. Gregory Möller, Ph.D., Associate Professor of Environmental Chemistry and Toxicology, Moscow, Indiana
3. Raghubir Sharma, Ph.D., D.V.M., Professor of Physiology and Pharmacology, Athens, Georgia

These experts collectively have knowledge of selenium's physical and chemical properties, toxicokinetics, key health end points, mechanisms of action, human and animal exposure, and quantification of risk to humans. All reviewers were selected in conformity with the conditions for peer review specified in Section 104(I)(13) of the Comprehensive Environmental Response, Compensation, and Liability Act, as amended.

Scientists from the Agency for Toxic Substances and Disease Registry (ATSDR) have reviewed the peer reviewers' comments and determined which comments will be included in the profile. A listing of the peer reviewers' comments not incorporated in the profile, with a brief explanation of the rationale for their exclusion, exists as part of the administrative record for this compound. A list of databases reviewed and a list of unpublished documents cited are also included in the administrative record.

The citation of the peer review panel should not be understood to imply its approval of the profile's final content. The responsibility for the content of this profile lies with the ATSDR.

CONTENTS

FOREWORD	v
CONTRIBUTORS	ix
PEER REVIEW	xi
LIST OF FIGURES	xvii
LIST OF TABLES	xix
1. PUBLIC HEALTH STATEMENT	1
1.1 WHAT IS SELENIUM?	1
1.2 WHAT HAPPENS TO SELENIUM WHEN IT ENTERS THE ENVIRONMENT?	2
1.3 HOW MIGHT I BE EXPOSED TO SELENIUM?	3
1.4 HOW CAN SELENIUM ENTER AND LEAVE MY BODY?	3
1.5 HOW CAN SELENIUM AFFECT MY HEALTH?	4
1.6 HOW CAN SELENIUM AFFECT CHILDREN?	7
1.7 HOW CAN FAMILIES REDUCE THE RISK OF EXPOSURE TO SELENIUM?	8
1.8 IS THERE A MEDICAL TEST TO DETERMINE WHETHER I HAVE BEEN EXPOSED TO SELENIUM?	9
1.9 WHAT RECOMMENDATIONS HAS THE FEDERAL GOVERNMENT MADE TO PROTECT HUMAN HEALTH?	10
1.10 WHERE CAN I GET MORE INFORMATION?	11
2. RELEVANCE TO PUBLIC HEALTH	13
2.1 BACKGROUND AND ENVIRONMENTAL EXPOSURES TO SELENIUM IN THE UNITED STATES	13
2.2 SUMMARY OF HEALTH EFFECTS	13
2.3 MINIMAL RISK LEVELS (MRLs)	20
3. HEALTH EFFECTS	23
3.1 INTRODUCTION	23
3.2 DISCUSSION OF HEALTH EFFECTS BY ROUTE OF EXPOSURE	24
3.2.1 Inhalation Exposure	26
3.2.1.1 Death	26
3.2.1.2 Systemic Effects	31
3.2.1.3 Immunological and Lymphoreticular Effects	36
3.2.1.4 Neurological Effects	36
3.2.1.5 Reproductive Effects	37
3.2.1.6 Developmental Effects	37
3.2.1.7 Cancer	37
3.2.2 Oral Exposure	37
3.2.2.1 Death	79
3.2.2.2 Systemic Effects	82
3.2.2.3 Immunological and Lymphoreticular Effects	102
3.2.2.4 Neurological Effects	106
3.2.2.4 Reproductive Effects	110

3.2.2.6	Developmental Effects	114
3.2.2.7	Cancer	117
3.2.3	Dermal Exposure	125
3.2.3.1	Death	125
3.2.3.2	Systemic Effects	125
3.2.3.3	Immunological and Lymphoreticular Effects	126
3.2.3.4	Neurological Effects	127
3.2.3.5	Reproductive Effects	127
3.2.3.6	Developmental Effects	127
3.2.3.7	Cancer	127
3.2.4	Other Routes of Exposure	128
3.3	GENOTOXICITY	129
3.4	TOXICOKINETICS	135
3.4.1	Absorption	136
3.4.1.1	Inhalation Exposure	136
3.4.1.2	Oral Exposure	143
3.4.1.3	Dermal Exposure	145
3.4.2	Distribution	146
3.4.2.1	Inhalation Exposure	147
3.4.2.2	Oral Exposure	147
3.4.2.3	Dermal Exposure	150
3.4.2.4	Other Routes of Exposure	150
3.4.3	Metabolism	151
3.4.4	Elimination and Excretion	158
3.4.4.1	Inhalation Exposure	158
3.4.4.2	Oral Exposure	158
3.4.4.3	Dermal Exposure	162
3.4.4.4	Other Routes of Exposure	162
3.4.5	Physiologically Based Pharmacokinetic (PBPK)/Pharmacodynamic (PD) Models	163
3.5	MECHANISMS OF ACTION	170
3.5.1	Pharmacokinetic Mechanisms	170
3.5.2	Mechanisms of Toxicity	172
3.5.3	Animal-to-Human Extrapolations	175
3.6	TOXICITIES MEDIATED THROUGH THE NEUROENDOCRINE AXIS	176
3.7	CHILDREN'S SUSCEPTIBILITY	179
3.8	BIOMARKERS OF EXPOSURE AND EFFECT	182
3.8.1	Biomarkers Used to Identify or Quantify Exposure to Selenium	183
3.8.2	Biomarkers Used to Characterize Effects Caused by Selenium	187
3.9	INTERACTIONS WITH OTHER CHEMICALS	188
3.10	POPULATIONS THAT ARE UNUSUALLY SUSCEPTIBLE	192
3.11	METHODS FOR REDUCING TOXIC EFFECTS	193
3.11.1	Reducing Peak Absorption Following Exposure	194
3.11.2	Reducing Body Burden	194
3.11.3	Interfering with the Mechanism of Action for Toxic Effects	195
3.12	ADEQUACY OF THE DATABASE	196
3.12.1	Existing Information on Health Effects of Selenium	196
3.12.2	Identification of Data Needs	199
3.12.3	Ongoing Studies	208
4.	CHEMICAL AND PHYSICAL INFORMATION	217
4.1	CHEMICAL IDENTITY	217

4.2	PHYSICAL AND CHEMICAL PROPERTIES.....	217
5.	PRODUCTION, IMPORT/EXPORT, USE, AND DISPOSAL.....	229
5.1	PRODUCTION.....	229
5.2	IMPORT/EXPORT.....	230
5.3	USE.....	230
5.4	DISPOSAL.....	234
6.	POTENTIAL FOR HUMAN EXPOSURE.....	235
6.1	OVERVIEW.....	235
6.2	RELEASES TO THE ENVIRONMENT.....	237
6.2.1	Air.....	237
6.2.2	Water.....	242
6.2.3	Soil.....	243
6.3	ENVIRONMENTAL FATE.....	243
6.3.1	Transport and Partitioning.....	243
6.3.2	Transformation and Degradation.....	246
6.3.2.1	Air.....	246
6.3.2.2	Water.....	247
6.3.2.3	Sediment and Soil.....	248
6.4	LEVELS MONITORED OR ESTIMATED IN THE ENVIRONMENT.....	249
6.4.1	Air.....	249
6.4.2	Water.....	250
6.4.3	Sediment and Soil.....	251
6.4.4	Other Environmental Media.....	252
6.5	GENERAL POPULATION AND OCCUPATIONAL EXPOSURE.....	275
6.6	EXPOSURES OF CHILDREN.....	279
6.7	POPULATIONS WITH POTENTIALLY HIGH EXPOSURES.....	280
6.8	ADEQUACY OF THE DATABASE.....	281
6.8.1	Identification of Data Needs.....	282
6.8.2	Ongoing Studies.....	285
7.	ANALYTICAL METHODS.....	287
7.1	BIOLOGICAL MATERIALS.....	287
7.2	ENVIRONMENTAL SAMPLES.....	297
7.3	ADEQUACY OF THE DATABASE.....	299
7.3.1	Identification of Data Needs.....	299
7.3.2	Ongoing Studies.....	301
8.	REGULATIONS AND ADVISORIES.....	303
9.	REFERENCES.....	315
10.	GLOSSARY.....	413

APPENDICES

A. ATSDR MINIMAL RISK LEVELS AND WORKSHEETS..... A-1

B. USER'S GUIDE..... B-1

C. ACRONYMS, ABBREVIATIONS, AND SYMBOLS C-1

LIST OF FIGURES

3-1.	Levels of Significant Exposure to Selenium—Inhalation.....	30
3-2.	Levels of Significant Exposure to Selenium—Oral.....	64
3-3.	Levels of Significant Exposure to Selenium Sulfides—Oral.....	75
3-4.	Metabolic Pathways for Selenium	152
3-5.	Proposed Pathway for Formation of Dimethyl Selenide from Selenite in Animals	157
3-6.	Activation and Reduction of Selenate to Selenite in Yeast <i>Saccharomyces cerevisiae</i>	159
3-7.	Conceptual Representation of a Physiologically Based Pharmacokinetic (PBPK) Model for a Hypothetical Chemical Substance	165
3-8.	Selenite Model, a Kinetic Model for Selenite Metabolism.....	167
3-9.	Selenomethionine Model, a Kinetic Model for Selenomethionine Metabolism.....	169
3-10.	Existing Information on Health Effects of Selenium.....	197
6-1.	Frequency of NPL Sites with Selenium Contamination	236

LIST OF TABLES

3-1.	Levels of Significant Exposure to Selenium—Inhalation.....	27
3-2.	Levels of Significant Exposure to Selenium—Oral.....	38
3-3.	Levels of Significant Exposure to Selenium Sulfides—Oral.....	71
3-4.	Genotoxicity of Selenium <i>In Vitro</i>	130
3-5.	Genotoxicity of Selenium <i>In Vivo</i>	132
3-6.	Selenium Concentrations in Human Tissues	137
3-7.	Biomarkers: Selenium Concentrations in Human Tissues and Fluids.....	140
3-8.	On-going Studies on Selenium Health Effects	209
4-1.	Chemical Identity of Selenium and Selected Compounds.....	218
4-2.	Physical and Chemical Properties of Selenium and Selenium Compounds	222
5-1.	Facilities that Produce, Process, or Use Selenium.....	231
5-2.	Facilities that Produce, Process, or Use Selenium Compounds.....	232
5-3.	Some Selenium Compounds and Their Uses.....	233
6-1.	Releases to the Environment from Facilities that Produce, Process, or Use Selenium.....	238
6-2.	Releases to the Environment from Facilities that Produce, Process, or Use Selenium Compounds	239
6-3.	Selenium Concentrations in Foods in the United States	254
6-4.	U.S. Food and Drug Administration—Total Diet Study (TDS)—Market Baskets 91-3 through 99-1.....	256
6-5.	Selenium Dietary Intake ($\mu\text{g}/\text{day}$) by Sex and Age for the Total U.S. Population, 1988–94	276
6-6.	Serum Selenium Concentrations ($\mu\text{g}/\text{L}$) in U.S. Population from NHANES III	278
6-7.	Ongoing Studies on Selenium.....	286
7-1.	Analytical Methods for Determining Selenium in Biological Materials	288
7-2.	Analytical Methods for Determining Selenium in Environmental Samples.....	290
8-1.	Regulations and Guidelines Applicable to Selenium.....	304

1. PUBLIC HEALTH STATEMENT

This public health statement tells you about selenium and the effects of exposure.

The Environmental Protection Agency (EPA) identifies the most serious hazardous waste sites in the nation. These sites make up the National Priorities List (NPL) and are the sites targeted for long-term federal cleanup activities. Selenium has been found in at least 508 of the 1,623 current or former NPL sites. However, the total number of NPL sites evaluated for selenium is not known. As more sites are evaluated, the sites at which selenium is found may increase. This information is important because exposure to selenium at high levels may harm you and because these sites may be sources of exposure. A minimum dietary level of selenium is required for good health.

When a substance is released from a large area, such as an industrial plant, or from a container, such as a drum or bottle, it enters the environment. This release does not always lead to exposure. You are exposed to a substance only when you come in contact with it. You may be exposed by breathing, eating, or drinking the substance, or by skin contact.

If you are exposed to selenium, many factors determine whether you'll be harmed. These factors include the dose (how much), the duration (how long), and how you come in contact with it/them. You must also consider the other chemicals you're exposed to and your age, sex, diet, family traits, lifestyle, and state of health.

1.1 WHAT IS SELENIUM?

Selenium is a naturally occurring, solid substance that is widely but unevenly distributed in the earth's crust. It is also commonly found in rocks and soil. Selenium, in its pure form of metallic gray to black crystals, is often referred to as elemental selenium or selenium dust. Elemental selenium is commercially produced, primarily as a by-product of copper refining. Selenium is not often found in the environment in its elemental form, but is usually combined with other

1. PUBLIC HEALTH STATEMENT

substances. Much of the selenium in rocks is combined with sulfide minerals or with silver, copper, lead, and nickel minerals. Selenium also combines with oxygen to form several substances that are white or colorless crystals. Some selenium compounds are gases. Selenium and its compounds are used in some photographic devices, gun bluing (a liquid solution used to clean the metal parts of a gun), plastics, paints, anti-dandruff shampoos, vitamin and mineral supplements, fungicides, and certain types of glass. For example, selenium sulfide is used in anti-dandruff shampoos by the common trade name Selsun Blue. Selenium is also used to prepare drugs and as a nutritional feed supplement for poultry and livestock. More information on the chemical and physical properties, production, and uses of selenium are found in Chapters 4 and 5.

1.2 WHAT HAPPENS TO SELENIUM WHEN IT ENTERS THE ENVIRONMENT?

Selenium occurs naturally in the environment. As an element, selenium cannot be created or destroyed, although selenium can change forms in the environment. Weathering of rocks and soils may result in low levels of selenium in water, which may be taken up by plants. Weathering also releases selenium into the air on fine dust-like particles. Volcanic eruptions may release selenium in air. Selenium commonly enters the air from burning coal or oil. Selenium that may be present in fossil fuels combines with oxygen when burned, which may then react with water to form soluble selenium compounds. Airborne particles of selenium, such as in ash, can settle on soil or surface water. Disposal of selenium in commercial products and waste could also increase the amount of selenium in soil. The forms and fate of selenium in soil depend largely on the acidity of the surroundings and its interaction with oxygen. In the absence of oxygen when the soil is acidic, the amount of selenium that can enter plants and organisms should be low. Elemental selenium that cannot dissolve in water and other insoluble forms of selenium are less mobile and will usually remain in the soil, posing smaller risk of exposure. Selenium compounds that can dissolve in water are sometimes very mobile. Thus, there is an increased chance of exposure to these compounds. Selenium may enter surface water in irrigation drainage waters. Some evidence indicates that selenium can be taken up in tissues of aquatic organisms and possibly increase in concentration as the selenium is passed up through the food chain. Selenium concentrations in aquatic organisms have been a problem as a result of

1. PUBLIC HEALTH STATEMENT

irrigation runoff in some dry areas of the United States. Chapter 6 contains more information on what happens to selenium in the environment.

1.3 HOW MIGHT I BE EXPOSED TO SELENIUM?

People are exposed to low levels of selenium daily through food, water, and air. Selenium is also an essential nutrient for humans and animals. However, selenium can be harmful when regularly taken in amounts higher than those needed for good health. People receive the majority of their daily intake of selenium from eating food, and to a lesser extent, from water intake. Estimates of the average intake of selenium from food for the U.S. population range from 71 to 152 millionths of a gram of selenium per person per day. Low levels of selenium can also be found in drinking water. Selenium levels are less than 10 parts of selenium in a billion parts of water (10 ppb) in 99.5% of drinking water sources tested. People may be exposed to higher-than-normal levels of selenium at hazardous waste sites by swallowing soil or water, or by breathing dust. In some parts of the United States, especially in the western states, some soils naturally have higher levels of selenium compounds. Some plants can build up selenium to levels that harm livestock feeding on them. In these areas, people could be exposed to too much selenium if they eat a lot of locally grown grains and vegetables or animal products that have built up high levels of selenium. People may also be exposed to selenium from industrial sources. Humans are normally not exposed to large amounts of selenium in the air, unless selenium dust or volatile selenium compounds are formed in their workplace. Occupations in which humans may be exposed to selenium in the air are the metal industries, selenium-recovery processes, paint manufacturing, and special trades. Chapter 6 contains more information on how people can be exposed to selenium.

1.4 HOW CAN SELENIUM ENTER AND LEAVE MY BODY?

Selenium from the environment mainly enters the body when people eat food containing selenium. The human body easily absorbs the organic selenium compounds (for example, selenoamino acids) when eaten, and makes them available where needed in the body. The

1. PUBLIC HEALTH STATEMENT

selenium in drinking water is usually in the form of inorganic sodium selenate and sodium selenite; these forms of selenium are also easily absorbed from the digestive tract. The human body can change these inorganic selenium compounds into forms that it can use. Selenium in the air may also enter your body when you breathe it.

Hazardous waste sites at which selenium is present could represent a major source of exposure. The way that selenium can enter the body from a particular site depends on such factors as whether vegetables are grown in soil in which selenium from the site has been deposited, whether water at the site contains selenium and is able to flow into drinking water supplies, and whether selenium dust blows into the air. As mentioned earlier, specific conditions at a site can greatly influence which selenium compounds form and whether they can move in the environment to places where people might be exposed. Therefore, it is important to know that the presence of selenium at a site does not necessarily mean that people are being exposed to it. Specific tests of locally grown food, drinking water, and air must be done to find out whether exposure is occurring. You should also be aware that selenium compounds, including those used in some medicated dandruff shampoos, are not easily absorbed through the skin.

Most of the selenium that enters the body quickly leaves the body, usually within 24 hours. Beyond what the body needs, selenium leaves mainly in the urine, but also in feces and breath. Selenium in the urine increases as the amount of the exposure goes up. Selenium can build up in the human body, however, if exposure levels are very high or if exposure occurs over a long time. The amount that builds up in the body depends on the chemical form of the selenium. It builds up mostly in the liver and kidneys but also in the blood, lungs, heart, and testes. Selenium can build up in the nails and in hair, depending on time and amount of exposure. Chapter 3 contains more information on how selenium enters and leaves the human body.

1.5 HOW CAN SELENIUM AFFECT MY HEALTH?

To protect the public from the harmful effects of toxic chemicals and to find ways to treat people who have been harmed, scientists use many tests.

1. PUBLIC HEALTH STATEMENT

One way to see if a chemical will hurt people is to learn how the chemical is absorbed, used, and released by the body; for some chemicals, animal testing may be necessary. Animal testing may also be used to identify health effects such as cancer or birth defects. Without laboratory animals, scientists would lose a basic method to get information needed to make wise decisions to protect public health. Scientists have the responsibility to treat research animals with care and compassion. Laws today protect the welfare of research animals, and scientists must comply with strict animal care guidelines.

The general public rarely breathes high levels of selenium, although some people may be exposed to selenium dust and selenium compounds in workplace air. Dizziness, fatigue, and irritation of mucous membranes have been reported in people exposed to selenium in workplace air at concentrations higher than legal levels. In extreme cases, collection of fluid in the lungs (pulmonary edema) and severe bronchitis have been reported. The exact exposure levels at which these effects might occur are not known, but they become more likely with increasing amounts of selenium and with increasing frequency of exposure.

The normal intake of selenium by eating food is enough to meet the Recommended Daily Allowance (RDA) for this essential nutrient. However, as discussed in Chapters 2 and 3 of this profile, selenium compounds can be harmful at daily dietary levels that are higher than needed. The seriousness of the effects of excess selenium depends on how much selenium is eaten and how often. Intentional or accidental swallowing of a large amount of sodium selenate or sodium selenite (for example, a very large quantity of selenium supplement pills) could be life-threatening without immediate medical treatment. Even if mildly excessive amounts of selenium are eaten over long periods, brittle hair and deformed nails can develop. In extreme cases, people may lose feeling and control in arms and legs. These health effects, called selenosis, were seen in several villages in China where people were exposed to foods high in selenium for months to years. No human populations in the United States have been reported with long-term selenium poisoning, including populations in the western part of the country where selenium levels are naturally high in the soil. Because most people in the United States eat foods produced in many different areas, overexposure to selenium in food is unlikely to occur.

1. PUBLIC HEALTH STATEMENT

In some regions of China where soil levels of selenium are very low, not eating enough selenium has resulted in health effects. Selenium is used by the body in antioxidant enzymes that protect against damage to tissues done by oxygen, and in an enzyme that affects growth and metabolism. Not eating enough selenium can cause heart problems and muscle pain. Muscle pain has also been noted in people fed intravenously for a long time with solutions that did not contain selenium. Babies born early may be more sensitive to not having enough selenium, and this may contribute to lung effects. In the United States, selenium in food is sufficient to meet the RDA and prevent harmful effects from not enough selenium.

Upon contact with human skin, industrial selenium compounds have been reported to cause rashes, redness, heat, swelling, and pain. Brief, acute exposure of the eyes to selenium dioxide as a dust or fume in workplace air may result in burning, irritation, and tearing. However, only people who work in industries that process or use selenium or selenium compounds are likely to come into contact with levels high enough to cause eye irritation.

Studies of laboratory animals and people show that most selenium compounds probably do not cause cancer. In fact, some studies of cancer in humans suggest that lower-than-normal selenium levels in the diet might increase the risk of cancer. Other studies suggest that dietary levels of selenium that are higher than normal might reduce the risk of cancer in humans. However, taking selenium so that your daily amount is greater than that required might just increase your risk of selenium poisoning.

Based on studies done until 1987, the International Agency for Research on Cancer (IARC) determined that selenium and selenium compounds could not be classified as to their ability to cause cancer in humans. However, since then, the EPA has determined that one specific form of selenium, called selenium sulfide, is a probable human carcinogen. Selenium sulfide is the only selenium compound shown to cause cancer in animals. Rats and mice that were fed selenium sulfide daily at very high levels developed cancer. Selenium sulfide is not present in foods, and it is a very different chemical from the organic and inorganic selenium compounds found in foods and in the environment. Also, if introduced into the environment, selenium sulfide does not dissolve readily in water and would probably bind tightly to the soil, further reducing any

1. PUBLIC HEALTH STATEMENT

chance of exposure. Because selenium sulfide is not absorbed through the skin, the use of anti-dandruff shampoos containing selenium sulfide is generally considered safe.

Very high amounts of selenium have caused decreased sperm counts, increased abnormal sperm, changes in the female reproductive cycle in rats, and changes in the menstrual cycle in monkeys. The relevance of the reproductive effects of selenium exposure in animals studied to potential reproductive effects in humans is not known. Selenium compounds have not been shown to cause birth defects in humans or in other mammals.

Chapter 3 contains more information on the health effects of selenium and selenium compounds in humans and animals.

1.6 HOW CAN SELENIUM AFFECT CHILDREN?

This section discusses potential health effects from exposures during the period from conception to maturity at 18 years of age in humans.

Children living near selenium waste sites or coal burning plants are likely to be exposed to higher environmental levels of selenium through breathing, touching soil, and eating contaminated soil. Children living in areas of China with high selenium in the soil had higher levels of selenium in the blood than adults from that area. Very few studies have looked at how selenium can affect the health of children. Children need small amounts of selenium for normal growth and development. Children will probably show the same sort of health effects from selenium exposure as adults, but some studies suggest that they may be less susceptible to health effects of selenium than adults.

We do not know if exposure to selenium could result in birth defects in people. Selenium compounds have not been shown to cause birth defects in humans or in other mammals. We have no information to suggest that there are any differences between children and adults in where selenium is found in the body or in how fast it enters or leaves the body. Studies in laboratory animals have shown that selenium crosses the placenta and enters the fetus. Studies in

1. PUBLIC HEALTH STATEMENT

humans show that infants are supplied with selenium through breast milk, and therefore, women who were exposed to selenium by living near a waste site might transfer selenium to their babies. However, babies in areas of China with high selenium in the soil did not show any signs of health effects due to selenium, even though some of their parents did.

1.7 HOW CAN FAMILIES REDUCE THE RISK OF EXPOSURE TO SELENIUM?

If your doctor finds that you have been exposed to significant amounts of selenium, ask whether your children might also be exposed. Your doctor might need to ask your state health department to investigate.

Since selenium occurs naturally in the environment, we cannot avoid exposure to it. Certain dietary supplements and anti-dandruff shampoos contain selenium in high levels. You should not exceed the recommended dosages when using these products.

Children living near selenium waste sites or coal burning plants are likely to be exposed to higher environmental levels of selenium through breathing, touching soil, and eating contaminated soil. Some children eat a lot of dirt. You should discourage your children from eating dirt. Make sure they wash their hands frequently and before eating. Discourage your children from putting their hands in their mouths or from other hand-to-mouth activity.

The primary route of human exposure to selenium is through eating food. People who irrigate their home gardens with groundwater containing high levels of selenium may grow and eat plants that contain high levels of selenium because this element is taken up in some plants. Fishermen and hunters of waterfowl who regularly eat fish and game from waterways with high selenium content may also consume above average levels of selenium. To reduce your family's exposure to selenium, obey any wildlife advisories issued by your state. Information on fish and wildlife advisories in your state is available from your state public health or natural resources department.

1. PUBLIC HEALTH STATEMENT

1.8 IS THERE A MEDICAL TEST TO DETERMINE WHETHER I HAVE BEEN EXPOSED TO SELENIUM?

Selenium can be measured in the blood, urine, and fingernails or toenails of exposed individuals. However, since selenium is an essential nutrient normally present in foods, low levels of selenium are normally found in body tissues and urine. Tests for selenium are most useful for people who have recently been exposed to high levels. Samples of blood, urine, or nails can be properly collected in a physician's office and sent to a laboratory that has the special equipment needed to measure selenium. Urine can be used to determine short-term exposure. Because red blood cells last about 120 days before they are replaced by newly made red blood cells, the presence of selenium in red blood cells can show whether a person was exposed to selenium during the 120 days before testing, but not if exposed more than 120 days before testing. Toenail clippings can be used to determine longer-term exposure.

Many methods are available to measure selenium levels in human tissue and the environment. However, none of the methods that are routinely available can measure or detect each selenium compound in one test, and better tests that measure lower levels of different selenium compounds are needed. Also, these tests cannot determine the exact levels of selenium you may have been exposed to or predict whether health effects will occur, even though very high amounts of selenium in blood are clearly related to selenosis. Some human as well as animal studies suggest that when people are exposed over a long period to higher-than-normal amounts of selenium, their bodies adjust to the higher amounts. Chapter 3 contains more information on studies that have measured selenium in blood and other human tissues.

The length of time that selenium stays in the body after exposure stops depends on the form of selenium to which the person was exposed. Thus, it is difficult to predict how useful a test will be if some time has gone by since exposure stopped. Chapter 7 contains more information on the methods available to measure selenium in human tissues and in the environment.

1. PUBLIC HEALTH STATEMENT

1.9 WHAT RECOMMENDATIONS HAS THE FEDERAL GOVERNMENT MADE TO PROTECT HUMAN HEALTH?

The federal government develops regulations and recommendations to protect public health.

Regulations can be enforced by law. Federal agencies that develop regulations for toxic substances include the Environmental Protection Agency (EPA), the Occupational Safety and Health Administration (OSHA), and the Food and Drug Administration (FDA).

Recommendations provide valuable guidelines to protect public health but cannot be enforced by law. Federal organizations that develop recommendations for toxic substances include the Agency for Toxic Substances and Disease Registry (ATSDR) and the National Institute for Occupational Safety and Health (NIOSH).

Regulations and recommendations can be expressed in not-to-exceed levels in air, water, soil, or food that are usually based on levels that affect animals; then they are adjusted to help protect people. Sometimes these not-to-exceed levels differ among federal organizations because of different exposure times (an 8-hour workday or a 24-hour day), the use of different animal studies, or other factors.

Recommendations and regulations are also periodically updated as more information becomes available. For the most current information, check with the federal agency or organization that provides it. Some regulations and recommendations for selenium include the following:

The EPA Office of Drinking Water regulates the amount of selenium allowed in drinking water. Public water supplies are not allowed to exceed 50 ppb total selenium.

The FDA regulations allow a level of 50 ppb of selenium in bottled water. OSHA is responsible for setting regulations on selenium levels allowable in the workplace. The exposure limit for selenium compounds in the air for an 8-hour period is 0.2 mg selenium/m³. Chapter 8 contains other regulations and guidelines for selenium.

1. PUBLIC HEALTH STATEMENT

1.10 WHERE CAN I GET MORE INFORMATION?

If you have any more questions or concerns, please contact your community or state health or environmental quality department, or contact ATSDR at the address and phone number below.

ATSDR can also tell you the location of occupational and environmental health clinics. These clinics specialize in recognizing, evaluating, and treating illnesses resulting from exposure to hazardous substances.

Toxicological profiles are also available on-line at www.atsdr.cdc.gov and on CD-ROM. You may request a copy of the ATSDR ToxProfiles CD-ROM by calling the information and technical assistance toll-free number at 1-888-42ATSDR (1-888-422-8737), by email at atsdric@cdc.gov, or by writing at:

Agency for Toxic Substances and Disease Registry
Division of Toxicology
1600 Clifton Road NE
Mailstop E-29
Atlanta, GA 30333
Fax: 1-404-498-0093

For-profit organizations may request a copy of final profiles from the following:

National Technical Information Service (NTIS)
5285 Port Royal Road
Springfield, VA 22161
Phone: 1-800-553-6847 or 1-703-605-6000
Web site: <http://www.ntis.gov/>

2. RELEVANCE TO PUBLIC HEALTH

2.1 BACKGROUND AND ENVIRONMENTAL EXPOSURES TO SELENIUM IN THE UNITED STATES

Selenium is an essential micronutrient for humans and animals that is found ubiquitously in the environment, being released from both natural and anthropogenic sources. The principal release of selenium into the environment from anthropogenic sources is from coal combustion. Natural sources of selenium include the weathering of selenium-containing rocks and soils, and volcanic eruptions. Selenium is found in most rocks and soils, and naturally occurs at low concentrations in surface waters and groundwaters of the United States. Accumulation of selenium in agricultural drainage waters has been documented in basins in the western United States, particularly in California. Ambient background concentrations of selenium in the air are very low, generally in the nanogram per cubic meter (ng/m³) range.

Exposure of the general population to selenium is primarily by ingestion of its organic and inorganic forms, both of which occur naturally in the diet. The greatest portion of dietary intake occurs from organic forms of selenium, mainly the amino acids selenomethionine and selenocysteine, in grains, cereals, and forage crops. The main inorganic sources of selenium in the diet are selenate and selenite, which are less absorbed than the organic forms. Other exposure pathways for selenium, which are of lesser importance, are water and air. Various estimates of the selenium intake for Americans have ranged from 0.071 to 0.152 mg selenium/day (approximately 1–2 µg/kg/day in adults). Some people living in areas with high soil concentrations of selenium (as in areas of the western United States) might have higher exposure because of the natural selenium levels found locally, particularly if they consume crops primarily grown in that area. Metal industry workers, health service professionals, mechanics, and painters may be exposed to higher levels of selenium than the general population or workers employed in other trades.

2.2 SUMMARY OF HEALTH EFFECTS

As an essential trace element in humans and animals, selenium is a biologically active part of a number of important proteins, particularly enzymes involved in antioxidant defense mechanisms (e.g., glutathione peroxidases), thyroid hormone metabolism (e.g., deiodinase enzymes), and redox control of intracellular

2. RELEVANCE TO PUBLIC HEALTH

reactions (e.g., thioredoxin reductase). Depending upon the level of intake, selenium can have nutritional or possibly toxic effects. Most people in the United States are unlikely to suffer from selenium deficiency. Although excessive intake of selenium can cause adverse health effects, these are generally observed at doses more than 5 times greater than the Recommended Dietary Allowance (RDA).

The current RDA for selenium, established by the Food and Nutrition Board of the National Research Council (National Academy of Sciences), is 55 µg/day for male and female adults (approximately 0.8 µg/kg/day). This recommendation represents a decrease from the previous RDA of 70 µg/day for males; 55 µg/day was already the RDA for females. The current NAS Tolerable Upper Intake Level (UL) for selenium is 400 µg/day for adults (approximately 5.7 µg/kg/day). At the time that the RDA was in the process of being reevaluated (i.e., late 1990s), selenium was found to have entered the environment from old mining operations in some northwestern U.S. locations. This resulted in public concern about the potential effects of selenium on livestock grazing in the vicinity, and ultimately possible effects in humans consuming food products from plants and animals raised in those areas. The combination of the increased concern regarding selenium toxicity and the reduction in the selenium RDA indicated to ATSDR that an Agency reevaluation of selenium from a toxicological perspective is warranted; the previous version of the ATSDR Toxicological Profile for Selenium was published in 1996.

Although selenium deficiency is not a health issue in the United States, it has been associated with two endemic diseases found in selenium-poor regions of China: a cardiovascular condition known as Keshan Disease and an osteoarthropathy called Kashin-Beck Disease. Keshan Disease is a cardiomyopathy characterized by cardiac enlargement, abnormal ECG patterns, cardiogenic shock, and congestive heart failure, with multifocal necrosis of the myocardium. The disease is reported to occur primarily in children and women of child-bearing age and has been successfully treated by selenium supplementation; however, a low incidence of cases persisting after selenium supplementation suggests that there may be other contributing factors. The evidence for the involvement of selenium in Kashin-Beck disease is less clear than for its involvement in Keshan disease. Kashin-Beck Disease is characterized by atrophy, degeneration, and necrosis of cartilage tissue, and occurs primarily in children between the ages of 5 and 13 years; it also has been successfully treated with selenium supplements. Chronically ill people and older people have been shown to have lower organ concentrations of selenium than healthy individuals, but it is not clear if this is a cause or consequence of aging or illness.

Relatively little information is available on health effects of elevated inhalation levels of selenium. The primary target organ in humans and laboratory animals in cases of acute, high-level inhalation exposure to

2. RELEVANCE TO PUBLIC HEALTH

selenium dusts or fumes is the lung, with cardiovascular, hepatic, nervous, and renal involvement as well. Lesser effects are observed in other organs/organ systems. Workers acutely exposed to high concentrations of elemental selenium dust have reported stomach pain and headaches, whereas workers briefly exposed to high levels of selenium dioxide dust experienced respiratory symptoms such as pulmonary edema, bronchial spasms, symptoms of asphyxiation and persistent bronchitis, elevated pulse rates, lowered blood pressure, vomiting, nausea, and irritability. No information is available on health effects in humans or laboratory animals from intermediate-duration (up to 1 year) inhalation exposure to selenium or selenium compounds. Regarding chronic inhalation exposure, several occupational studies describe respiratory effects such as irritation of the nose, respiratory tract, and lungs, bronchial spasms, and coughing following exposure to selenium dioxide or elemental selenium as dust. Respiratory symptoms similar to those reported for occupationally-exposed humans have been seen in animals inhaling high doses of elemental selenium fumes or dust, and studies of animals with acute inhalation exposure to hydrogen selenide or elemental selenium fumes or dust have reported hepatocellular degeneration and atrophy of the liver.

Acute oral exposure to extremely high levels of selenium (e.g., several thousand times more than normal daily intake) produces nausea, vomiting, and diarrhea in both humans and laboratory animals. Acute oral exposure of humans to selenium has occasionally caused cardiovascular symptoms, such as tachycardia, but no electrocardiographic abnormalities were found in individuals from a human population chronically exposed to selenium. In laboratory animals, acute- and intermediate-duration oral exposure to very large amounts of selenium (approximately 100 times normal human intake) has produced myocardial degeneration in laboratory animals.

Chronic oral intake of very high levels of selenium (10–20 times more than normal) can produce selenosis in humans, the major effects of which are dermal and neurological. As shown by affected populations in China, chronic dietary exposure to these excess levels of selenium has caused diseased nails and skin and hair loss, as well neurological problems, including unsteady gait and paralysis. Additional information on selenosis is summarized in the following subsection of this chapter. In contrast, studies of people living in areas of naturally occurring high selenium concentrations in the United States have not revealed adverse health effects in those populations. This difference may result from a lower (~2-fold) selenium exposure in the U.S. population compared to the Chinese population, as well as a better balanced, higher protein diet in the United States, which could lead to reduced toxicity of selenium through interactions with dietary components.

2. RELEVANCE TO PUBLIC HEALTH

Intermediate and chronic oral exposure of livestock to high levels of dietary selenium compounds also produces dermal and neurological effects. Studies in rats and other laboratory animals with high selenium tissue concentrations demonstrate that many organ systems retain selenium and are affected. The primary adverse effects in laboratory animals exposed to inorganic selenium salts or to selenium-containing amino acids are cardiovascular, gastrointestinal, hematological, hepatic, dermal, immunological, neurological, and reproductive, although doses causing these effects are generally at least 5 times higher than normal daily selenium intake. A condition (syndrome) referred to as “blind staggers” has been repeatedly observed in cattle feeding off vegetation in areas with high selenium content in the soil. However, the neurological effects have not been replicated in experimentally-exposed cattle receiving doses of selenium sufficient to induce hoof lesions, and thus, the neurological signs associated with “blind staggers” may be due to other compounds found within this vegetation.

Some evidence for effects on the endocrine system has also been found following long-term oral exposure to elevated levels of dietary selenium in humans and rats. In humans, blood levels of thyroid T₃ hormone (triiodothyronine) decreased in response to increased dietary selenium for durations of 3 months and longer at intakes several times higher than normal intake, although the hormone levels remained within the normal range. In rats, type-I-deiodinase activity decreased in response to increased exposure to selenium for several months, but the levels of thyroid hormones in these animals did not show a consistent pattern.

Studies of Chinese populations and laboratory animals exposed to high levels of organic and/or inorganic selenium compounds have not found evidence of selective teratogenic effects in mammals.

There is no evidence to support a causal association between selenium compounds and cancer in humans. In fact, some epidemiological and experimental evidence suggests that selenium exposure under certain conditions may contribute to a reduction in cancer risk. The chemopreventive potential of supplemental selenium is currently under research. Selenium sulfide and ethyl selenac are the only selenium compounds that have been shown to be carcinogenic upon oral administration in rodents; however, significant exposure of humans to these chemical forms of selenium is extremely unlikely.

Additional information on main health effects of selenium in humans and animals is summarized below and detailed in Chapter 3.

2. RELEVANCE TO PUBLIC HEALTH

Selenosis. Following chronic oral exposure to excessive amounts of the organic selenium compounds in food, the two principal clinical conditions observed in humans are dermal and neurological effects, as described most completely in the epidemiological study of endemic selenosis in the People's Republic of China. The dermal manifestations of selenosis include loss of hair, deformation and loss of nails, and discoloration and excessive decay of teeth, while neurological effects include numbness, paralysis, and occasional hemiplegia. The average dietary intake of selenium associated with selenosis in these people has been estimated to be 1,270 µg/day (~0.02 mg/kg/day, or 10–20 times higher than normal daily intake).

Loss of hair and malformation of hooves in pigs, horses, and cattle, and poliomyelomalacia in pigs have been reported to occur following long-term exposure to excessive amounts (more than 30 times the normal dietary amount of selenium) of the organic selenium compounds found in seleniferous plants. Histologically, swine with selenium-induced neurological signs exhibit bilateral macroscopic lesions of the ventral horn of the spinal cord. The selenium in the selenium-accumulating plant *Astragalus bisulcatus* appears to be a more potent neurotoxicant than D,L-selenomethionine or selenate. The form of selenium in *A. bisulcatus* is unknown, although it is apparently nonprotein. Myocardial degeneration has been experimentally produced in cattle, sheep, and swine (as well as in laboratory mammals) by acute and longer-term exposures to inorganic salts of selenium, but it is unclear whether seleniferous grains or forages, or other natural sources of selenium, cause the same cardiomyopathy.

The neurological signs and histopathology observed in livestock following oral exposure to excess selenium compounds have not been recorded in laboratory animals. This suggests that (1) small laboratory mammals might not be appropriate models for selenium toxicity in humans due to toxicokinetic differences (e.g., laboratory animals absorb selenium compounds to a lesser extent, or metabolize and/or excrete selenium compounds more quickly), (2) some as yet unidentified organic form of selenium contributes to the neurological manifestations of chronic selenosis in humans and in livestock, (3) unrecognized confounding factors, such as other plant toxins, have contributed to the neurological syndrome associated with chronic selenosis in field studies of humans and livestock, and/or (4) species differences in interactions between selenium and other nutrients or xenobiotics, such as vitamin E and methionine, which have been found to be antagonistic to selenium toxicity

Endocrine Effects. Selenium is a component of all three members of the deiodinase enzyme family, the enzymes responsible for deiodination of the thyroid hormones, and has a physiological role in the

2. RELEVANCE TO PUBLIC HEALTH

control of thyroid hormone levels. Significant decreases in serum T₃ hormone levels have been observed in humans that were environmentally or experimentally exposed to elevated dietary levels of selenium (several times higher than normal). However, the T₃ hormone levels observed in these studies were still within the normal human range, so the biological impact of this change is unclear. The effect of increased dietary selenium on other thyroid hormones is also uncertain. Intermediate-duration studies in rats show a decrease in type-I-deiodinase activity in response to elevated selenium; however, the levels of thyroid hormones in these animals did not show any consistent changes.

Reduced growth rate of young animals and weight loss in older animals are two of the most common effects in experimental animals following long-term oral intake of excessive levels of inorganic and organic compounds of selenium. It is quite possible that selenium-induced reduction in growth has a thyroid or other endocrine component. For example, selenite treatment of young rats decreased somatomedin C levels, although somatomedin C was not a sensitive index of elevated selenium exposure in humans from a high-selenium area of South Dakota, and growth hormone secretion in response to the growth hormone releasing factor was also reduced in selenium-treated rats. The primary endocrine target of selenium leading to decreased growth has yet to be elucidated. Pancreatic toxicity has been observed following excess selenium exposure. Cytoplasmic flocculation was observed in lambs treated with a single oral dose of selenite, and pancreatic damage, which was not further described, was noted in rats following chronic oral treatment with selenate or selenite. Pancreatic toxicity associated with excessive selenium exposure is likely related to the unique ability of that organ to accumulate the element.

Reproductive Effects. In humans, no correlation has been found between selenium levels in seminal fluid and sperm count or mobility. No significant increase in spontaneous abortions was reported among women chronically exposed to drinking water containing increased selenium, but the concentration was not considered to be unusually high. In animals, oral exposure to high doses of sodium selenate or selenite (at least 8 times greater than those normally supplied by an adequate diet) caused increased numbers of abnormal sperm, as well as testicular hypertrophy, degeneration, and atrophy in male rats, and affected the estrous cycle in female rats and mice. The animals that showed these effects were not mated, so it is not clear if fertility was affected. Oral treatment with L-selenomethionine similarly caused disturbances in the menstrual cycle (anovulation, short luteal and follicular phases) in monkeys. Selenium deficiency has also been reported to cause decreased sperm production and motility in rats. The relevance of the reproductive effects of high and low levels of selenium in laboratory animals to potential reproductive effects in humans is not known.

2. RELEVANCE TO PUBLIC HEALTH

Hepatic Effects. Liver effects have not been reported for humans exposed to excessive amounts of selenium. No significant abnormalities were found in blood levels of liver enzymes in people living in high selenium areas, or in liver morphology (ultrasonographic examination) of individuals suffering from severe symptoms of selenosis. In experimental animals and livestock, however, the liver has been shown to be affected following inhalation or oral exposure to different kinds of selenium compounds. Hepatocellular degeneration occurred in guinea pigs following short-term inhalation exposure to excessive levels (hundreds of times higher than normal) of elemental selenium dust (8 mg/m^3) or hydrogen selenide (33 mg/m^3). Cirrhosis, hepatocellular degeneration, and changes in liver enzyme levels in serum have been reported for rats, pigs, and mice orally exposed to selenite, selenate, or organic selenium. The oral doses of selenium producing the various adverse liver effects were approximately 10 times the amount normally found in an adequate diet. Excessive dietary exposure to selenium sulfide (several thousands of times higher than normal selenium intake) produced frank hepatotoxicity in rats, but not in mice. Although the liver appears to be the primary target organ for the oral toxicity of selenium in experimental animals following intermediate and chronic exposure, liver cirrhosis or dysfunction has not been a notable component of the clinical manifestations of chronic selenosis in humans. The lack of evidence of liver damage in humans due to selenosis, despite all of the animal data to the contrary, suggests a problem with the animal models of the disease.

Renal Effects. No reports of renal effects in humans were located. In animals, mild kidney effects have been observed following oral exposure to selenium at levels several hundred times higher than normal human intake. These effects include hydropic degeneration in sheep following a single dose of 5 mg Se/kg/day as sodium selenite. Rats appear to be more sensitive than mice to renal effects of repeated oral exposures to selenium compounds. A dose-related increase in renal papilla degeneration, described as mild to minimal, was observed in rats at very high levels of selenate or selenite (0.5 mg Se/kg/day , several hundreds of times higher than normal human intake) in the drinking water for 13 weeks, although increased kidney weight was the only renal effect in similarly exposed mice. Mice that were given excessive daily doses of selenium sulfide by gavage (464 mg Se/kg/day for 13 weeks), however, developed interstitial nephritis.

2. RELEVANCE TO PUBLIC HEALTH

2.3 MINIMAL RISK LEVELS (MRLs)***Inhalation MRLs***

No MRLs were derived for inhalation exposure to selenium because of insufficient quantitative data concerning both human and animal exposures. Data on the health effects of inhaled selenium in humans are available from studies of occupationally exposed workers (Clinton 1947; Glover 1970; Holness et al. 1989; Kinnigkeit 1962; Wilson 1962). These studies suggest that the respiratory system is the most sensitive end point for inhaled selenium dust, but they do not provide quantitative measurements of exposure levels and are frequently confounded by concurrent exposures to other chemicals. Laboratory animal studies support the respiratory system as the main target of selenium inhalation toxicity (Dudley and Miller 1941; Hall et al. 1951), but the available data are for acute exposures to high concentrations of selenium that also produced serious health effects, including death.

Oral MRLs

No MRLs were derived for acute or intermediate oral exposure to selenium because of insufficient information regarding adverse health effect levels in humans and experimental animals. For acute exposure, no quantitative data are available from studies of humans. Some acute oral animal studies identify lowest-observed-adverse-effect levels (LOAELs) for organ weight changes, behavioral changes, and reduced body weight, but these occur at doses similar to those producing serious LOAELs for paralysis and developmental effects in other mammalian studies.

Information on health effects of intermediate-duration (15–365 days) oral exposure to selenium in humans is mainly available from a 120-day experimental study of men who were exposed to a controlled diet of foods naturally low or naturally high in selenium (Hawkes and Turek 2001; Hawkes et al. 2001). Eleven subjects were fed diets providing selenium intake levels of 0.6 µg/kg/day for 21 days (baseline period), followed by 0.2 µg/kg/day (6 subjects) or 4 µg/kg/day (5 subjects) for the subsequent 99 days. This was more a nutritional study than a toxicological study, as indicated by selenium intake levels that bracketed the current RDA (~0.8 µg Se/kg/day) and were well below the tolerable upper limit (~5.7 µg Se/kg/day) recommended by the Food and Nutrition Board (NAS 2000). Comprehensive evaluations were performed that included serum levels of thyroid hormones (T₃ and TSH) and reproductive hormones (testosterone, follicle-stimulating hormone, luteinizing hormone, prolactin, estradiol, and progesterone), sperm quality indices (number and concentration, motility, forward progression and velocity, and morphology), and immunological end points (including serum immunoglobulin levels, lymphocyte counts

2. RELEVANCE TO PUBLIC HEALTH

and phenotypes, natural-killer cell activity, proliferative response of lymphocytes to mitogenic stimulation, delayed-type hypersensitivity skin responses to recall antigens, and antibody responses to diphtheria-tetanus and influenza vaccines). Effects were essentially limited to subclinical changes in thyroid hormones and sperm motility, which are not considered to be toxicologically meaningful. Serum T₃ concentrations decreased in the high selenium group and increased in the low selenium group, but all values apparently remained within the normal human range. Serum TSH concentrations increased in the high-selenium group with no change in the low-selenium group, but values also remained in the normal range. Sperm motility was slightly lower than the baseline value in the high selenium group at study termination. The decrease in sperm motility cannot be clearly attributed to selenium because the effect was not consistent over the duration of exposure, and is unlikely to be adverse because it is at the low end of the normal range and was not accompanied by any changes in other indices of sperm movement (progression or forward velocity) or sperm numbers or morphology.

Effects in intermediate-duration studies in experimental animals include reductions in liver enzyme activities, changes in liver and body weights, and histological changes in the liver and kidney, but the relevance of these effects to selenium toxicity in humans is questionable. For example, humans with selenosis did not display any changes in serum levels of liver enzymes or morphological damage to the liver, as shown by ultrasonographic examination (Yang et al. 1989a). Further, the liver and kidney effects in animal studies occurred at doses (≥ 0.2 mg/kg/day) that were considerably higher than the 4 $\mu\text{g}/\text{kg}/\text{day}$ intake level that caused the subclinical thyroid hormone and sperm motility alterations in humans (Hawkes and Turek 2001; Hawkes et al. 2001). Although the human experimental study identifies a no-observed-adverse-effect level (NOAEL) of 4 $\mu\text{g}/\text{kg}/\text{day}$ for sensitive endocrine and male reproductive end points, it is an inappropriate basis for derivation of an intermediate oral MRL. In particular, because this is a free-standing NOAEL, proximity to the LOAEL region is not known, and the use of the NOAEL to derive an MRL would yield a value that is in the range of the selenium RDA (approximately 0.8 $\mu\text{g}/\text{kg}/\text{day}$) (NAS 2000) and below the chronic oral MRL derived below.

- An MRL of 0.005 mg/kg/day (5 $\mu\text{g}/\text{kg}/\text{day}$) has been derived for chronic oral exposure (>365 days) to selenium.

This MRL is based upon a study by Yang and Zhou (1994), who examined of a group of five individuals who were recovering from selenosis, and who were drawn from a larger population from an area of China where selenosis occurred (Yang et al. 1989a, 1989b). The study collected data on selenium levels in the diet, blood, nails, hair, urine, and milk of residents at three sites with low, medium, and high selenium, and compared the incidence of clinical symptoms of selenosis (morphological changes in fingernails)

2. RELEVANCE TO PUBLIC HEALTH

with dietary intake of selenium and selenium levels in blood. The average adult body weight was 55 kg (Yang et al., 1989b). It was found that selenium levels in blood corresponded to the dietary intake of selenium, and that symptoms of selenosis occurred at or above a selenium intake level of 910 $\mu\text{g}/\text{day}$ (0.016 mg/kg/day) (Yang et al. 1989a). In 1992, Yang and Zhou (1994) reexamined five individuals from the high selenium site who had been suffering from symptoms of selenosis (loss of fingernails and hair), but were recovering (nails were regrowing). Since their earlier report, the living conditions of the population had improved; they had been cautioned against consuming high selenium foods, and part of their diet from locally produced corn had been replaced with rice or cereals. Yang and Zhou (1994) found that the concentration of selenium in the blood of these individuals had fallen from 1,346 $\mu\text{g}/\text{L}$ (measured in 1986) to 968 $\mu\text{g}/\text{L}$ (measured in 1992). Using a regression equation derived from the data in an earlier report (Yang et al. 1989b), it was calculated that the dietary intake of selenium associated with selenosis in these individuals was 1,270 $\mu\text{g}/\text{day}$, while an intake of 819 $\mu\text{g Se}/\text{day}$ (was associated with recovery (Yang and Zhou 1994).

The chronic oral MRL is based on a NOAEL of 819 $\mu\text{g}/\text{day}$ (0.015 mg/kg/day) for disappearance of symptoms of selenosis in recovering individuals (Yang and Zhou 1994) and uses an uncertainty factor of 3 for human variability. An uncertainty factor of 3 was considered appropriate because the individuals in this study were sensitive individuals drawn from a larger population and because of supporting studies, as discussed in Appendix A. The NOAEL used to derive the MRL is consistent with NOAELs observed for other human populations (Longnecker et al. 1991). The MRL is about 2.5–5 times higher than normal selenium intake levels of 71–152 $\mu\text{g}/\text{day}$ (approximately 0.001–0.002 mg/kg/day) (DHHS 2002; FDA 1982a; Levander 1987; Pennington et al. 1989; Schrauzer and White 1978; Schubert et al. 1987; Welsh et al. 1981), and approximately 6 times greater than the RDA for selenium of 55 $\mu\text{g}/\text{day}$ (\sim 0.0008 mg/kg/day) (NAS 2000). The MRL does not represent a threshold for toxicity, but a daily intake that ATSDR considers to be safe for all populations. The exact point above the MRL at which effects might occur in sensitive individuals is uncertain.

3. HEALTH EFFECTS

3.1 INTRODUCTION

The primary purpose of this chapter is to provide public health officials, physicians, toxicologists, and other interested individuals and groups with an overall perspective on the toxicology of selenium. It contains descriptions and evaluations of toxicological studies and epidemiological investigations and provides conclusions, where possible, on the relevance of toxicity and toxicokinetic data to public health.

A glossary and list of acronyms, abbreviations, and symbols can be found at the end of this profile.

Selenium is a naturally occurring element that is widely distributed in rocks and soils. Although selenium has been reported at hazardous waste sites where it can occur in many forms, analysis of specific forms present at these sites has not been performed, and it is unclear how much selenium is present in some of the sites. Selenium has multiple oxidation states (valence states) including -2, 0, +4, and +6. The type of selenium found is a result of its oxidation state, which may vary according to ambient conditions, such as pH and microbial activity.

Elemental selenium (selenium[0]) is rarely found naturally, but it is stable in soils. Selenates (selenium[+6]) and selenites (selenium[+4]) are water soluble and can be found in water. Sodium selenate is among the most mobile forms of selenium because of its high solubility and inability to adsorb to soil particles. More insoluble forms, such as elemental selenium, are less mobile; therefore, there is less risk for exposure. Because of greater bioavailability, water-soluble selenium compounds are probably more toxic than elemental selenium by any route. Selenium is found in nature complexed with multiple compounds, and although various forms are discussed in the profile, many others exist. Some plants, such as alfalfa, yeasts, white grain, and cruciferous species (e.g., mustard, cabbage, broccoli, and cauliflower), are efficient accumulators of selenium. Plants can contain organic selenium primarily in the form of the amino acids, selenomethionine and selenocysteine, along with the dimethyl selenides. Elemental selenium can be oxidized to form selenium dioxide. While the products of oxidation might be expected at the soil surface, elemental selenium would be the expected predominant form in soils or sediments where anaerobic conditions exist. Selenium sulfides, used in some anti-dandruff shampoos, are not very water soluble and, therefore, like elemental selenium, are relatively immobile in the environment.

3. HEALTH EFFECTS

Much of the selenium released to the environment comes from the burning of coal and other fossil fuels, and from other industrial processes such as the production of rubber. For more information on the physical and chemical properties of selenium, see Chapter 4. For more information on the potential for human exposure, see Chapter 6.

In humans and animals, selenium is an essential nutrient that plays a role in protecting tissues from oxidative damage as a component of glutathione peroxidase. It is also found in the deiodinases, including type I and II iodothyronine 5'-deiodinase, which convert thyroxine to triiodothyronine and in thioredoxin reductase, which catalyses the NADPH-dependent reduction of the redox protein thioredoxin. The biologically active form of selenium in these enzymes is the modified amino acid, selenocysteine. Humans and animals can be exposed to increased amounts of selenium through the use of dietary supplements containing selenium. The nutritional role of selenium is further discussed in Section 3.4. Although selenium is an essential nutrient, exposure to high levels via inhalation or ingestion may cause adverse health effects. The mechanism by which selenium exerts toxic effects is unknown, but existing theories are discussed in Section 3.5. Most of the studies available on health effects involve exposure to selenite, selenate, and a form found in foods (selenomethionine).

Several factors should be considered when evaluating the toxicity of selenium compounds. The purity and grade of the particular test substance used in the testing are important factors. For example, in studies of selenium sulfide compounds, the amounts of mono- and disulfides are often not specified by the study authors. The solubility and the particle size of selenium compounds can also influence their toxicity.

3.2 DISCUSSION OF HEALTH EFFECTS BY ROUTE OF EXPOSURE

To help public health professionals and others address the needs of persons living or working near hazardous waste sites, the information in this section is organized first by route of exposure (inhalation, oral, and dermal) and then by health effect (death, systemic, immunological, neurological, reproductive, developmental, genotoxic, and carcinogenic effects). These data are discussed in terms of three exposure periods: acute (14 days or less), intermediate (15–364 days), and chronic (365 days or more).

Levels of significant exposure for each route and duration are presented in Tables 3-1, 3-2, and 3-3 and illustrated in Figures 3-1, 3-2, and 3-3. The points in the figures showing no-observed-adverse-effect

3. HEALTH EFFECTS

levels (NOAELs) or lowest-observed-adverse-effect levels (LOAELs) reflect the actual doses (levels of exposure) used in the studies. The oral doses presented in these tables and figures, as well as those included in the text of this chapter, are expressed on a per kg of body weight basis. LOAELs have been classified into "less serious" or "serious" effects. "Serious" effects are those that evoke failure in a biological system and can lead to morbidity or mortality (e.g., acute respiratory distress or death). "Less serious" effects are those that are not expected to cause significant dysfunction or death, or those whose significance to the organism is not entirely clear. ATSDR acknowledges that a considerable amount of judgment may be required in establishing whether an end point should be classified as a NOAEL, "less serious" LOAEL, or "serious" LOAEL, and that in some cases, there will be insufficient data to decide whether the effect is indicative of significant dysfunction. However, the Agency has established guidelines and policies that are used to classify these end points. ATSDR believes that there is sufficient merit in this approach to warrant an attempt at distinguishing between "less serious" and "serious" effects. The distinction between "less serious" effects and "serious" effects is considered to be important because it helps the users of the profiles to identify levels of exposure at which major health effects start to appear. LOAELs or NOAELs should also help in determining whether or not the effects vary with dose and/or duration, and place into perspective the possible significance of these effects to human health.

The significance of the exposure levels shown in the Levels of Significant Exposure (LSE) tables (Tables 3-1, 3-2, and 3-3) and figures (Figures 3-1, 3-2, and 3-3) may differ depending on the user's perspective. Public health officials and others concerned with appropriate actions to take at hazardous waste sites may want information on levels of exposure associated with more subtle effects in humans or animals (LOAELs) or exposure levels below which no adverse effects (NOAELs) have been observed. Estimates of levels posing minimal risk to humans (Minimal Risk Levels or MRLs) may be of interest to health professionals and citizens alike.

Estimates of exposure levels posing minimal risk to humans (Minimal Risk Levels or MRLs) have been made for selenium. An MRL is defined as an estimate of daily human exposure to a substance that is likely to be without an appreciable risk of adverse effects (noncarcinogenic) over a specified duration of exposure. MRLs are derived when reliable and sufficient data exist to identify the target organ(s) of effect or the most sensitive health effect(s) for a specific duration within a given route of exposure. MRLs are based on noncancerous health effects only and do not consider carcinogenic effects. MRLs can be derived for acute, intermediate, and chronic duration exposures for inhalation and oral routes. Appropriate methodology does not exist to develop MRLs for dermal exposure.

3. HEALTH EFFECTS

Although methods have been established to derive these levels (Barnes and Dourson 1988; EPA 1990b), uncertainties are associated with these techniques. Furthermore, ATSDR acknowledges additional uncertainties inherent in the application of the procedures to derive less than lifetime MRLs. As an example, acute inhalation MRLs may not be protective for health effects that are delayed in development or are acquired following repeated acute insults, such as hypersensitivity reactions, asthma, chronic bronchitis, or multiple chemical exposure. As these kinds of health effects data become available and methods to assess levels of significant human exposure improve, these MRLs will be revised.

A User's Guide has been provided at the end of this profile (see Appendix B). This guide should aid in the interpretation of the tables and figures for Levels of Significant Exposure and the MRLs.

3.2.1 Inhalation Exposure

Table 3-1 and Figure 3-1 describe the health effects observed in experimental animals that inhaled elemental selenium dust or hydrogen selenide. Studies of other forms of selenium are not presented in the LSE tables and figures (Table 3-1 and Figure 3-1) because either the reporting of the studies was incomplete or no studies on other forms were located. All doses are expressed in terms of total selenium.

3.2.1.1 Death

No studies were located regarding death in humans after inhalation of elemental selenium or selenium compounds.

In animals, the acute lethality of hydrogen selenide and elemental selenium dust when inhaled has been investigated. In guinea pigs exposed to hydrogen selenide for 2, 4, or 8 hours, 5/16 died within 10 days of exposure at 12 mg selenium/m³, 3/16 died at 6 mg selenium/m³, and 8/16 died at 6 mg selenium/m³, respectively (Dudley and Miller 1941).

No deaths were observed among rabbits or guinea pigs exposed to elemental selenium dust at levels of 31 mg selenium/m³ for 4 hours every other day for 8 exposure days (Hall et al. 1951). Higher levels were not tested.

Table 3-1 Levels of Significant Exposure to Selenium - Inhalation

Key to figure ^a	Species (Strain)	Exposure/ Duration/ Frequency (Specific Route)	System	LOAEL			Reference Chemical Form
				NOAEL (mg/m ³)	Less Serious (mg/m ³)	Serious (mg/m ³)	
ACUTE EXPOSURE							
Death							
1	Gn Pig (NS)	4 hr				6 (3/16 died)	Dudley and Miller 1941 hydrogen selenide
2	Gn Pig (NS)	8 hr				1 (8/16 died)	Dudley and Miller 1941 hydrogen selenide
3	Gn Pig (NS)	2 hr				12 (8/16 died)	Dudley and Miller 1941 hydrogen selenide
Systemic							
4	Rat (NS)	8 hr	Resp			33 F (pulmonary hemorrhage, pneumonitis)	Hall et al. 1951 elemental
			Hepatic		33 F (congestion; mild central atrophy)		
			Renal	33 F			
			Endocr	33 F			
			Bd Wt	33 F			
5	Gn Pig (NS)	4 hr	Resp			8 (pneumonitis)	Dudley and Miller 1941 hydrogen selenide
			Cardio	8			
			Hepatic		8 (fatty metamorphosis, increased liver weight)		
			Renal	8			
			Endocr	8			

Table 3-1 Levels of Significant Exposure to Selenium - Inhalation

(continued)

Key to figure ^a	Species (Strain)	Exposure/ Duration/ Frequency (Specific Route)	System	LOAEL			Reference Chemical Form
				NOAEL (mg/m ³)	Less Serious (mg/m ³)	Serious (mg/m ³)	
6	Gn Pig (NS)	8 d 4hr/2d	Resp		33 M (mild congestion; mild to moderate interstitial pneumonitis; slight emphysema)		Hall et al. 1951 elemental
			Cardio	33 M			
			Hepatic		33 M (congestion; central atrophy; fatty metamorphosis)		
			Renal	33 M			
			Bd Wt	33 M			
7	Rabbit (NS)	8 d 4hr/2d	Resp		33 F (congestion, mild pneumonitis)		Hall et al. 1951 elemental
			Cardio	33 F			
			Hepatic	33 F			
			Renal	33 F			
			Bd Wt	33 F			
8	Immuno/ Rat (NS)	Lymphoret 8 hr		33		Hall et al. 1951 elemental	

Table 3-1 Levels of Significant Exposure to Selenium - Inhalation

(continued)

Key to figure ^a	Species (Strain)	Exposure/ Duration/ Frequency (Specific Route)	System	LOAEL			Reference Chemical Form
				NOAEL (mg/m ³)	Less Serious (mg/m ³)	Serious (mg/m ³)	
9	Gn Pig (NS)	4 hr			8 (splenic hyperplasia)		Dudley and Miller 1941 hydrogen selenide

a The number corresponds to entries in Figure 3-1.

Bd Wt = body weight; Cardio = cardiovascular; CEL = cancer effect level; d = day(s); (F) = feed; Endocr = endocrine; F = female; gastro = gastrointestinal; Hemato = hematological; hr = hour(s); LOAEL = lowest-observed-adverse-effect level; M = male; Metab = metabolic; Musc/skel = musculoskeletal; NOAEL = no-observed-adverse-effect level; (NS) = not specified; Resp = respiratory

Figure 3-1. Levels of Significant Exposure to Selenium - Inhalation

Acute (≤ 14 days)

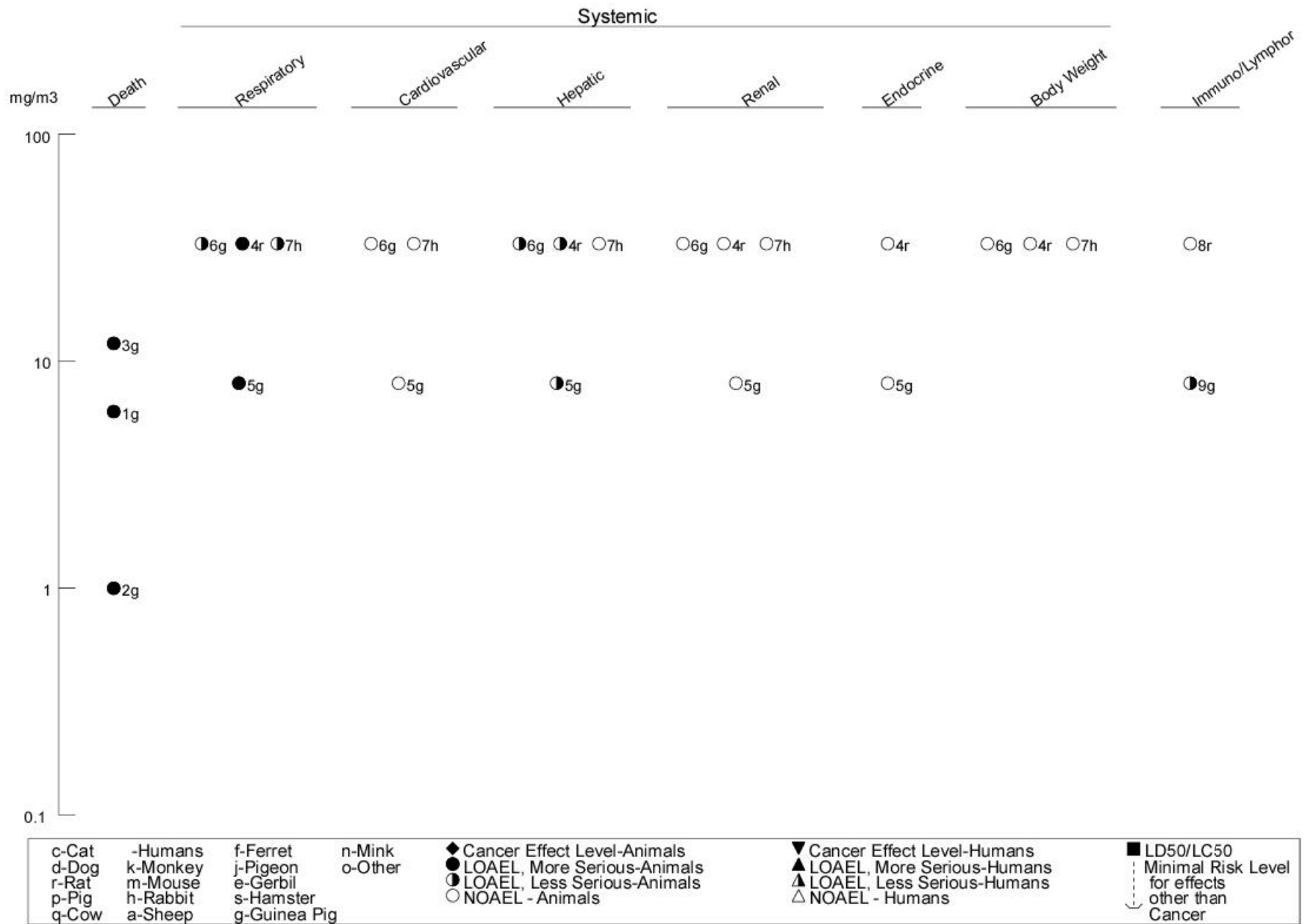

3. HEALTH EFFECTS

All LOAEL values from each reliable study for death in each species and duration category are recorded in Table 3-1 and plotted in Figure 3-1.

3.2.1.2 Systemic Effects

The selenium compounds that are most likely to be encountered in air in occupational settings are dusts of elemental selenium, hydrogen selenide, and selenium dioxide. Other volatile selenium compounds (e.g., dimethyl selenide, dimethyl diselenide) might be encountered in some naturally occurring situations. Because selenium is converted from one form to another, as in plant biosynthesis of selenoamino acids, it is not clear which specific forms may be encountered at hazardous waste sites. If a hazardous waste site specifically contains deposits of compounds of selenium, those compounds could be released off-site in dust or air. Toxicity data for exposures via inhalation are available for elemental selenium, selenium dioxide, selenium oxychloride, hydrogen selenide, and dimethyl selenide. Because there are few studies of inhalation of selenium of any single form, all available studies of inhalation exposures to selenium compounds will be included in this discussion.

In studies of human occupational exposures, it appears that the respiratory tract is the primary site of injury after inhalation of selenium dust or selenium compounds, but gastrointestinal (possibly due to swallowed selenium) and cardiovascular effects, as well as irritation of the skin and eyes, also occur. Little of the available information for humans, however, relates health effects exclusively to measured concentrations of the selenium dust or compounds because of the possibility of concurrent exposures to multiple substances in the workplace. In animals, the respiratory tract is also the primary site of injury following inhalation exposure to selenium dust and hydrogen selenide. Hematological and hepatic effects have also been noted in animals. Inhalation data from laboratory animal studies are available only for acute exposures.

No information was located regarding hematological, musculoskeletal, dermal, or ocular effects in humans or laboratory animals after inhalation exposure to selenium or selenium compounds. The systemic effects that have been observed after inhalation exposure are discussed below. The highest NOAEL values and all LOAEL values for each reliable study for systemic effects in each species and duration category are recorded in Table 3-1 and plotted in Figure 3-1.

3. HEALTH EFFECTS

Respiratory Effects. In humans, the respiratory system is the primary site of injury after inhalation of elemental selenium or selenium compounds. The largest number of reported human exposures occurred in occupational settings, especially in industries that extract, mine, treat, or process selenium-bearing minerals and in industries that use selenium or selenium compounds in manufacturing. The reports of occupational exposure do not link observed symptoms to specific air concentrations of elemental selenium or selenium compounds. Several reports, however, have noted common effects associated with inhalation exposure in occupational settings.

Selenium dioxide is formed when selenium is heated in air. Direct exposure to selenium dioxide is, therefore, primarily an occupational hazard and not likely to be a risk at hazardous waste sites. Selenium dioxide forms selenious acid on contact with water, including perspiration, and can cause severe irritation. Acute inhalation of large quantities of selenium dioxide powder can produce pulmonary edema as a result of the local irritant effect on alveoli (Glover 1970). Bronchial spasms, symptoms of asphyxiation, and persistent bronchitis have been noted in workers briefly exposed to high concentrations of selenium dioxide (Wilson 1962). Kinnigkeit (1962) reported that selenium dioxide concentrations of 0.007–0.05 mg selenium/m³ in a selenium rectifier plant produced slight tracheobronchitis in 9 of 62 exposed workers.

Hydrogen selenide, a highly poisonous selenium compound, is a gas at room temperature, with a density much higher than air. Selenium oxychloride, also highly toxic, is more irritating and corrosive to the human respiratory tract than are other forms of selenium because the compound hydrolyzes to hydrogen chloride (HCl), which can then form hydrochloric acid in humid air and in the respiratory tract (Dudley 1938). Hydrogen selenide and selenium oxychloride are occupational exposure hazards that are not expected to be much of a concern at hazardous waste sites.

Acute inhalation exposure to elemental selenium dust, possibly including some selenium dioxide, in occupational settings has been shown to irritate mucous membranes in the nose and throat and produce coughing, nosebleed, loss of olfaction, and in heavily exposed workers, dyspnea, bronchial spasms, bronchitis, and chemical pneumonia (Clinton 1947; Hamilton 1949). Chronic exposure of 40 workers at a copper refinery produced increased nose irritation and sputum (Holness et al. 1989). The exact concentration of selenium was not given, but the concentration was reported to exceed 0.2 mg selenium/m³. Confounding variables in this study include concurrent exposure to several other metals including copper, nickel, silver, lead, arsenic, and tellurium.

3. HEALTH EFFECTS

In experimental animals, the respiratory tract is the primary site of injury following acute inhalation exposure to elemental selenium and selenium compounds. Rats exposed to selenium fumes (selenium concentration and particle size were not reported) for 2–16 minutes experienced moderate to severe respiratory effects, including hemorrhage and edema of the lungs (Hall et al. 1951). Rats exposed to selenium dust (average particle diameter, 1.2 μm) at levels of 33 mg selenium/ m^3 for 8 hours experienced severe respiratory effects, including hemorrhage and edema of the lungs, and several animals died (Hall et al. 1951). Histopathological examinations of surviving animals revealed chronic interstitial pneumonitis. Acute exposure of rabbits and guinea pigs to selenium dust (average particle diameter, 1.2 μm) at a concentration of 33 mg selenium/ m^3 resulted in mild interstitial pneumonitis or congestion, and slight emphysema in both species (Hall et al. 1951). Other histological findings included vascular lymphocytic infiltration and intra-alveolar foci of large macrophages.

Acute inhalation exposure of guinea pigs to 8 mg selenium/ m^3 as hydrogen selenide for 4 hours produced diffuse bronchopneumonia and pneumonitis (Dudley and Miller 1941). The investigators do not indicate if any of these guinea pigs died as a result of the exposure. Histologic examination of animals that died following exposure to higher concentrations revealed thickening of the alveolar walls and congestion of alveolar capillaries (Dudley and Miller 1937). In contrast, 1-hour exposure of rats to 25,958 mg selenium/ m^3 as dimethyl selenide produced only minor effects (increased weight of lung and liver) 1 day postexposure. These changes disappeared by 7 days postexposure (Al-Bayati et al. 1992). Enzymatic methylation of selenium compounds is the primary route of detoxification and may explain the low toxicity of dimethyl selenide (Al-Bayati et al. 1992). Although this form of selenium is environmentally relevant since it is formed in soil, plants, and microorganisms, dimethyl selenide appears to be relatively nontoxic in comparison to occupational exposure to hydrogen selenide.

The effects of intratracheal instillation of selenium on pulmonary function may be dependent on the form in which it is supplied (Nonavinakere et al. 1999). Instillation of 0.06 mg selenium/100 g body weight as selenium dioxide produced a significant decrease in respiratory rate and a significant increase in lung resistance compared with controls. Instillation with 0.06 mg selenium/110 g body weight as seleno-L-methionine also produced a decrease in respiratory rate and an increase in lung resistance, but the values were not significantly different from controls.

Intratracheal instillation of 0.3 mg selenium as sodium selenite in male Hartley-guinea pigs decreased dynamic-lung-compliance and increased pulmonary resistance compared with control animals instilled with saline (Bell et al. 1997). Analysis of bronchoalveolar-lavage fluid showed increased activities of

3. HEALTH EFFECTS

lactate dehydrogenase, β -glucuronidase, alkaline phosphatase, and protein, suggesting damage to lung tissue.

Histological analysis of guinea pigs that received single intratracheal instillations of 0.3 mg selenium as sodium selenite found mild acute inflammation in approximately one-third of the lung tissue and a noticeable amount of sloughed epithelium and mucus within the bronchi (Bell et al. 2000). Lungs of animals treated with 0.06 mg selenium showed neutrophils aggregated in the alveoli and some dilation of the alveoli suggestive of emphysema. Relative lung weights and the ratio of wet/dry lung weight were increased in the selenium-treated animals compared with controls; the increase was only significant for those receiving the higher dose of selenium. Leukocyte counts in bronchoalveolar-lavage fluid were decreased for selenium-treated animals compared with controls, and the difference was significant for the animals receiving 0.3 mg selenium, but not the 0.06 mg dosage.

No studies were located regarding respiratory effects in animals after intermediate or chronic inhalation of selenium or selenium compounds.

Cardiovascular Effects. Several workers experienced symptoms of shock, including lower blood pressure and elevated pulse rates, following an acute exposure (at most 20 minutes) to selenium dioxide fumes resulting from a fire (Wilson 1962). The subjects were treated with oxygen and inhalation of ammonia vapor, and pulse rates were normalized within 3 hours.

Cardiovascular effects were not observed in guinea pigs exposed to hydrogen selenide at 8 mg selenium/m³ for 4 hours (Dudley and Miller 1941), or in guinea pigs and rabbits exposed to elemental selenium dust (average particle diameter, 1.2 μ m) every other day at 33 mg selenium/m³ for eight 4-hour exposure periods (Hall et al. 1951).

Gastrointestinal Effects. Vomiting and nausea were reported in workers exposed to high concentrations of selenium dioxide for a maximum of 20 minutes during a fire (Wilson 1962). Stomach pain was frequently reported by workers exposed to elemental selenium and selenium dioxide at a selenium rectifier plant (Glover 1967), and by copper refinery workers exposed to an unspecified form of selenium (Holness et al. 1989). Exposure concentrations were not reported for the rectifier plant, but were >0.2 mg selenium/m³ at the copper refinery.

3. HEALTH EFFECTS

No studies were located regarding gastrointestinal effects in animals after inhalation of selenium or selenium compounds.

Hepatic Effects. No studies were located regarding hepatic effects in humans after inhalation of selenium or selenium compounds.

Hepatotoxicity has been observed in experimental animals following inhalation exposure to elemental selenium dust and to hydrogen selenide. One month after an 8-hour exposure to elemental selenium dust at a level of 33 mg selenium/m³, most rats exhibited slight liver congestion and a few exhibited mild centrilobular atrophy (Hall et al. 1951). In contrast, 1 week after exposure to 25,958 mg selenium/m³ as dimethyl selenide for 1 hour, rats showed no observable changes in the liver (Al-Bayati et al. 1992). Three weeks following acute exposure to elemental selenium dust at a level of 33 mg selenium/m³ for 4 hours every other day for 8 days, 4/10 guinea pigs exhibited slight hepatic congestion with mild central atrophy and 2/10 showed some fatty hepatocellular degeneration (Dudley and Miller 1941). In contrast, exposure of guinea pigs to lower concentrations of selenium (8 mg/m³), as hydrogen selenide, for a single 4-hour period produced mild fatty hepatocellular metamorphosis (Dudley and Miller 1941).

Renal Effects. No studies were located regarding renal effects in humans after inhalation of selenium or selenium compounds.

The kidneys do not appear to be affected in guinea pigs (Dudley and Miller 1941; Hall et al. 1951) after acute inhalation exposure to 33 mg selenium/m³ as hydrogen selenide for 8 hours or to 8 mg selenium/m³ as elemental selenium dust for 4 hours. Likewise, the kidneys were not affected in rabbits following acute inhalation exposure to 33 mg selenium/m³ as hydrogen selenide for 8 hours (Hall et al. 1951) or in rats following acute inhalation exposure to 25,958 mg selenium/m³ as dimethyl selenide for 1 hour or to 33 mg selenium/m³ as hydrogen selenide for 8 hours (Al-Bayati et al. 1992; Hall et al. 1951).

Endocrine Effects. No studies were located regarding endocrine effects in humans after inhalation of selenium or selenium compounds.

No histopathological changes in the adrenal gland were observed in guinea pigs exposed to hydrogen selenide at 8 mg selenium/m³ for 4 hours (Dudley and Miller 1941) or in rats exposed to elemental selenium at 33 mg selenium/m³ for 8 hours (Hall et al. 1951).

3. HEALTH EFFECTS

Body Weight Effects. No studies were located regarding effects on body weight in humans following inhalation of selenium or selenium compounds.

No effects on body weight were observed in guinea pigs following a single 8-hour exposure to elemental selenium at 33 mg selenium/m³ or in guinea pigs and rabbits exposed to elemental selenium dust at 33 mg selenium/m³ every other day for 4 hours for a total of eight exposures (Hall et al. 1951).

3.2.1.3 Immunological and Lymphoreticular Effects

No studies were located regarding immunological or lymphoreticular effects in humans after inhalation exposure to selenium or selenium compounds.

Lymphoid hyperplasia was noted in the spleen of guinea pigs following a single 4-hour exposure at 8 mg selenium/m³ as hydrogen selenide (Dudley and Miller 1941). Histopathological changes in the spleen were not observed in guinea pigs exposed to elemental selenium dust (average particle diameter, 1.2 µm) at 33 mg selenium/m³ for 8 hours (Hall et al. 1951). Injury to the spleen was observed in guinea pigs following exposure for 4 hours, every other day, for 8 days to elemental selenium dust at a level of 33 mg selenium/m³ (Hall et al. 1951). Specific effects included congestion of the spleen, fissuring red pulp, and increased polymorphonuclear leukocytes (Hall et al. 1951).

3.2.1.4 Neurological Effects

Information concerning possible neurological effects caused by inhalation of selenium or selenium compounds is limited. Severe frontal headaches were reported by workers exposed during an accident to high concentrations of selenium fumes (compound not stated) for approximately 2 minutes (Clinton 1947). Workers at a selenium rectifier plant reported symptoms of malaise and irritability when working with selenium (exposure was probably to selenium dioxide and elemental selenium, but the form was not stated) (Glover 1967). The symptoms resolved whenever the workers were moved to other work.

Urinary concentrations of selenium were about 0.08 mg/L, compared to 0.024–0.034 mg/L in unexposed workers.

No studies were located regarding neurological effects in animals after inhalation of selenium or selenium compounds.

3. HEALTH EFFECTS

No studies were located regarding the following health effects in humans or animals after inhalation exposure to selenium or selenium compounds:

3.2.1.5 Reproductive Effects

3.2.1.6 Developmental Effects

3.2.1.7 Cancer

There are no epidemiologic data that support a causal association between the inhalation of elemental selenium dusts or selenium compounds and the induction of cancer in humans (Gerhardsson et al. 1986; Wester et al. 1981). In one study, postmortem samples were collected from copper smelter workers who were exposed to several different airborne compounds, including selenium compounds. Samples from lung cancer cases had lower concentrations of selenium in lung tissue than samples from controls or from workers who had died from other causes (Gerhardsson et al. 1986). In another autopsy study of smelter workers, Wester et al. (1981) found that the selenium concentrations in kidney tissues from workers who had died of malignancies were lower than the selenium concentrations in kidney tissues from workers who died of other causes. Further discussions regarding the cancer protective effects of selenium can be found in Section 3.2.2.7.

No studies were located regarding carcinogenic effects in laboratory animals after inhalation exposure to selenium or selenium compounds.

3.2.2 Oral Exposure

Table 3-2 and Figure 3-2 describe the health effects observed in humans and experimental animals associated with dose and duration of oral exposure to selenium and selenium compounds (i.e., elemental selenium dust, selenium dioxide dissolved in water [selenious acid], sodium selenate, sodium selenite, potassium selenate, and dietary selenium compounds, which include selenoamino acids). All doses for these compounds are expressed in terms of total selenium. Table 3-3 and Figure 3-3 describe health effects observed in laboratory animals following oral exposure to selenium sulfides (SeS_2 and SeS) at varying doses and exposure durations. All doses for selenium sulfide compounds are expressed in terms

Table 3-2 Levels of Significant Exposure to Selenium - Oral

Key to figure ^a	Species (Strain)	Exposure/ Duration/ Frequency (Specific Route)	System	LOAEL			Reference Chemical Form
				NOAEL (mg/kg/day)	Less Serious (mg/kg/day)	Serious (mg/kg/day)	
ACUTE EXPOSURE							
Death							
1	Rat (Sprague- Dawley)	once (G)				6700 M (LD50)	Cummins and Kimura 1971 elemental
2	Rat (Sprague- Dawley)	once (GW)				7 M (LD50)	Cummins and Kimura 1971 selenite
3	Rat (Sprague- Dawley)	14 d ad lib (W)				0.418 F (7/12 died)	NTP 1996 sodium selenate
4	Rat (NS)	once (G)				4.8 F (LD50)	Pletnikova 1970 selenite
5	Rat (Wistar)	once (GW)				48 (LD50)	Singh and Junnarkar 1991 selenium dioxide
6	Mouse (NS)	once (G)				3.2 M (LD50)	Pletnikova 1970 selenite
7	Mouse (ICR)	once (G)				35.9 M (LD50)	Sayato et al. 1993 D,L-selenocystine
8	Mouse (Swiss)	once (GW)				16 M (LD50)	Singh and Junnarkar 1991 selenium dioxide
9	Gn Pig (NS)	once (G)				2.3 F (LD50)	Pletnikova 1970 selenite

Table 3-2 Levels of Significant Exposure to Selenium - Oral

(continued)

Key to figure ^a	Species (Strain)	Exposure/ Duration/ Frequency (Specific Route)	System	LOAEL			Reference Chemical Form
				NOAEL (mg/kg/day)	Less Serious (mg/kg/day)	Serious (mg/kg/day)	
10	Rabbit (NS)	once (G)				1 F (LD50)	Pletnikova 1970 selenite
Systemic							
11	Rat (Sprague- Dawley)	14 d ad lib (W)	Bd Wt	0.251 F		0.418 F (significant (36%) reduction in body weight)	NTP 1996 sodium selenate
12	Mouse (BALB/c)	14 d ad lib (W)	Hemato	0.38 M	0.82 M (significant increase in red blood cell count)		Johnson et al. 2000 Selenite
			Hepatic	0.38 M	0.82 M (significant decrease in relative liver weight)		
			Renal	0.17 M	0.38 M (significant increase in relative kidney weight)		
			Bd Wt	0.38 M	0.82 (significant decrease in body weight gain)		
13	Mouse (BALB/c)	14 d ad lib (W)	Hemato	1.36 M			Johnson et al. 2000 selenomethionine
			Hepatic	1.36 M			
			Renal	1.36 M			
			Bd Wt	1.36 M			

Table 3-2 Levels of Significant Exposure to Selenium - Oral

(continued)

Key to figure ^a	Species (Strain)	Exposure/ Duration/ Frequency (Specific Route)	System	LOAEL			Reference Chemical Form
				NOAEL (mg/kg/day)	Less Serious (mg/kg/day)	Serious (mg/kg/day)	
14	Pig (NS)	5 d	Resp	1.25			Panter et al. 1996 organic
			Cardio	1.25			
			Hepatic	1.25			
			Renal	1.25			
			Dermal	1.25			
			Bd Wt		1.25 (5% loss of body weight)		
Immuno/ Lymphoret							
15	Mouse (BALB/c)	14 d ad lib (W)		0.38 M	0.82 M (increased proliferation of splenic lymphocytes and LPS-induced production of TNF alpha and IL-1beta)		Johnson et al. 2000 Selenite
16	Mouse (BALB/c)	14 d ad lib (W)		1.36 M			Johnson et al. 2000 selenomethionine
Neurological							
17	Mouse (Swiss)	once (GW)			1.6 (decreased activity, muscle tone, touch response, respiration; hypothermia)		Singh and Junnarkar 1991 selenium dioxide
18	Mouse (BALB/c)	14 d ad lib (W)		0.24 M	0.58 M (significant increase in the levels of striatal dihydroxyphenylacetic acid and homovanillic acid)		Tsunoda et al. 2000 Selenite

Table 3-2 Levels of Significant Exposure to Selenium - Oral

(continued)

Key to figure ^a	Species (Strain)	Exposure/ Duration/ Frequency (Specific Route)	System	LOAEL			Reference Chemical Form	
				NOAEL (mg/kg/day)	Less Serious (mg/kg/day)	Serious (mg/kg/day)		
19	Mouse (BALB/c)	14 d ad lib (W)		1.96 M			Tsunoda et al. 2000 Organic selenium	
20	Pig (NS)	10 d 1x/d (C)				1.3	(hypoactivity, focal symmetrical poliomalacia, histopathological lesions in brain and spinal cord)	Wilson et al. 1989 selenite
Developmental								
21	Hamster (Syrian LKV)	once Gd 8 (GW)		7.1		7.9	(encephalocele; decreased crown-rump length)	Ferm et al. 1990 selenite
22	Hamster (Syrian LKV)	once Gd 8 (GW)				7.1	(encephalocele)	Ferm et al. 1990 selenate
23	Hamster (Syrian LKV)	once Gd 8 (GW)			5.9		(decreased fetal crown-rump length)	Ferm et al. 1990 selenomethionine
INTERMEDIATE EXPOSURE								
Death								
24	Rat (Sprague- Dawley)	6 wk ad lib (F)				0.48 M	(1/8 died)	Halverson et al. 1966 selenite
25	Rat (Sprague- Dawley)	6 wk ad lib (F)				0.4 M	(1/8 died)	Halverson et al. 1966 organic
26	Rat (Fischer- 344)	13 wk (W)				2.54	(20/20 died)	NTP 1994 selenate

Table 3-2 Levels of Significant Exposure to Selenium - Oral

(continued)

Key to figure ^a	Species (Strain)	Exposure/ Duration/ Frequency (Specific Route)	System	LOAEL			Reference Chemical Form
				NOAEL (mg/kg/day)	Less Serious (mg/kg/day)	Serious (mg/kg/day)	
27	Rat (Fischer- 344)	13 wk (W)				1.67 F (2/10 died)	NTP 1994 selenite
28	Rat (Sprague- Dawley)	4-6 wk ad lib (W)				0.84 M (4/6 died)	Palmer and Olson 1974 selenite
29	Rat (Sprague- Dawley)	4-6 wk ad lib (W)				0.84 M (2/6 died)	Palmer and Olson 1974 selenate
30	Rat (Wistar)	1 yr daily ad lib (W)				1.05 M (1/3 died) 1.05 F (3/5 died)	Rosenfeld and Beath 1954 selenate
31	Rat (BLU:[LE])	365 d (W)				0.28 (50% males died at 58 days 50% females died at 160 days)	Schroeder and Mitchener 1971a selenite
32	Mouse (ICR)	30 d 6d/wk (G)				14.2 M (15/15 died)	Sayato et al. 1993 D,L-selenocystine
33	Human	20 wk (IN)	Endocr	0.001			Duffield et al. 1999
34	Human	102d (F)	Endocr	0.0039 M			Hawkes and Turek 2001 dietary

Table 3-2 Levels of Significant Exposure to Selenium - Oral

(continued)

Key to figure ^a	Species (Strain)	Exposure/ Duration/ Frequency (Specific Route)	System	LOAEL			Reference Chemical Form
				NOAEL (mg/kg/day)	Less Serious (mg/kg/day)	Serious (mg/kg/day)	
35	Human	120d (F)	Hemato	0.004 M			Hawkes et al. 2001 dietary
36	Monkey (Macaca fascicularis)	gd 20-50 1x/d (GW)	Gastro	0.025 F	0.15 F (vomiting)		Tarantal et al. 1991 selenomethionine
			Bd Wt	0.025 F	0.15 F (increased weight loss)		
37	Rat (Wistar)	110 d ad lib (F)	Endocr	0.105 M	0.105 M (significant reduction in type I deiodinase activity)		Behne et al. 1992 sodium selenite
			Bd Wt	0.105 M			
38	Rat (Wistar)	110 d ad lib (F)	Endocr		0.118 M (significant reduction in type I deiodinase activity)		Behne et al. 1992 selenomethionine
			Bd Wt		0.118 M (significant reduction in body weight (15%))		
39	Rat (Sprague- Dawley)	2 mo ad lib (F)	Hepatic	0.1 M	0.2 M (nodular regenerative hyperplasia, increased relative liver weight)		Bioulac-Sage et al. 1992 selenite
			Bd Wt	0.2 M			

Table 3-2 Levels of Significant Exposure to Selenium - Oral

(continued)

Key to figure ^a	Species (Strain)	Exposure/ Duration/ Frequency (Specific Route)	System	LOAEL			Reference Chemical Form
				NOAEL (mg/kg/day)	Less Serious (mg/kg/day)	Serious (mg/kg/day)	
40	Rat (Sprague-Dawley)	8 wk (F)	Resp	0.45 M			Chen et al. 1993 selenite
			Cardio	0.45 M			
			Gastro	0.45 M			
			Hepatic		0.45 M (diffuse panlobular vacuolar accumulation of glycogen and lipid)		
			Renal	0.45 M			
			Bd Wt		0.25 M (final body weights about 14% lower than controls)	0.35 M (final body weights about 29% lower than controls)	
41	Rat (Sprague-Dawley)	40 d ad lib (F)	Hemato	0.27 M			Eder et al. 1995 sodium selenite
			Endocr	0.026 M	0.055 M (significant reduction in serum tri-iodothyronine levels)		
			Bd Wt	0.27 M			
42	Rat (Sprague-Dawley)	6 wk ad lib (F)	Hemato	0.24 M	0.32 M (23% decrease in hemoglobin)	0.56 M (79% decrease in hemoglobin)	Halverson et al. 1966 organic
			Hepatic		0.4 M (6-fold increase in bilirubin)		
			Endocr	0.32 M	0.4 M (pancreas weight 1.4 times greater than diet restricted controls)		
			Bd Wt	0.32		0.4 M (body weight gain 36% lower than controls)	

Table 3-2 Levels of Significant Exposure to Selenium - Oral

(continued)

Key to figure ^a	Species (Strain)	Exposure/ Duration/ Frequency (Specific Route)	System	LOAEL		Reference Chemical Form
				NOAEL (mg/kg/day)	Less Serious (mg/kg/day)	
43	Rat (Sprague- Dawley)	6 wk ad lib (F)	Endocr		0.09 M (significant increase in serum TSH (~30%))	Hotz et al. 1997 sodium selenate
			Bd Wt	0.09 M		
			Metab		0.09 M (significant increase in GSH-Px in kidney (~30%) and erythrocytes (~100%))	
44	Rat (Wistar)	3 mo 1x/d (F)	Hepatic	0.002 M (sporadic infiltrations of mononuclear cells in portal canals and weak activation of Kupffer cells)	0.005 M (distinct swelling of Kupffer cells in dilated sinusoidal vessels and necrotic areas comprising single groups of hepatocytes)	Kolodziejczyk et al. 2000 sodium selenite

Table 3-2 Levels of Significant Exposure to Selenium - Oral

(continued)

Key to figure ^a	Species (Strain)	Exposure/ Duration/ Frequency (Specific Route)	System	LOAEL			Reference Chemical Form
				NOAEL (mg/kg/day)	Less Serious (mg/kg/day)	Serious (mg/kg/day)	
45	Rat (Fischer- 344) (W)	13 wk	Resp	1.57 M			NTP 1994 selenate
			Cardio	1.57 M			
			Gastro	1.57 M			
			Hemato	0.92 M	1.57 M (increased hematocrit and hemoglobin associated with decreased water intake)		
			Musc/skel	1.57 M			
			Hepatic	0.92 M	1.57 M (increased bile acids indicating cholestasis)		
			Renal	0.31 F	0.47 F (minimal papilla degeneration of the kidneys)		
			Endocr	1.57 M			
			Ocular	1.57 M			
Bd Wt	0.47 F	0.88 F (body weights 10% less than controls)	1.35 F (body weights 29% less than controls, associated with decreased water intake)				

Table 3-2 Levels of Significant Exposure to Selenium - Oral

(continued)

Key to figure ^a	Species (Strain)	Exposure/ Duration/ Frequency (Specific Route)	System	LOAEL			Reference Chemical Form
				NOAEL (mg/kg/day)	Less Serious (mg/kg/day)	Serious (mg/kg/day)	
46	Rat (Fischer- 344)	13 wk (W)	Resp	1.67 F			NTP 1994 selenite
			Cardio	1.67 F			
			Gastro	1.67 F			
			Hemato	0.86 F	1.67 F (increased hematocrit associated with decreased water intake)		
			Musc/skel	1.67 F			
			Hepatic	1.67 F			
			Renal	0.28 F	0.5 F (mild papilla degeneration)		
			Endocr	1.67 F			
			Ocular	1.67 F			
			Bd Wt	0.98 M		1.59 M (body weights 34% less than controls; associated with decreased water intake)	
47	Rat (Sprague-Dawley)	23-29 d ad lib (W)	Bd Wt	0.167 ^b M 0.209 F	0.293 ^b M (significant (11%) reduction in body weight) 0.334 F	0.418 ^b (significant (20% male, 39% female) reduction in body weight)	NTP 1996 sodium selenate
48	Rat (Sprague-Dawley)	4-6 wk ad lib (W)	Hepatic			0.84 M (cirrhosis)	Palmer and Olson 1974 selenate
			Bd Wt		0.42 M (body weight gain 10% lower than controls)		

Table 3-2 Levels of Significant Exposure to Selenium - Oral

(continued)

Key to figure ^a	Species (Strain)	Exposure/ Duration/ Frequency (Specific Route)	System	LOAEL			Reference Chemical Form
				NOAEL (mg/kg/day)	Less Serious (mg/kg/day)	Serious (mg/kg/day)	
49	Rat (Sprague-Dawley)	6 wk ad lib (F)	Bd Wt	0.125 M			Salbe and Levander 1990a selenate
50	Rat (Sprague-Dawley)	6 wk ad lib (F)	Bd Wt	0.125 M			Salbe and Levander 1990a selenomethionine
51	Rat (Wistar)	3-6 wks ad lib (W)	Endocr		0.64 F (decreased somatomedin C)		Thorlacius-Ussing 1990 selenite
			Bd Wt			0.64 F (body weight gain 30% lower than controls)	
52	Rat (Wistar)	12-14 wk ad lib	Cardio			0.324 (degeneration of heart tissue with disruption of myofibrils and sarcomeres)	Turan et al. 1999a sodium selenite
			Hepatic			0.324 (degeneration of liver tissue with dilation of sinusoidal capillaries)	
			Bd Wt		0.324 (significant decrease in body weight (17%))		
53	Mouse (ICR)	90 d (G)	Hepatic	2.4 M	4.7 M (increased serum aspartate aminotransferase and alanine aminotransferase)		Hasegawa et al. 1994 D,L-selenocystine
			Bd Wt	2.4 M	4.7 M (body weights 16% lower than controls)	7.1 M (body weights 22% lower than controls)	

Table 3-2 Levels of Significant Exposure to Selenium - Oral

(continued)

Key to figure ^a	Species (Strain)	Exposure/ Duration/ Frequency (Specific Route)	System	LOAEL			Reference Chemical Form
				NOAEL (mg/kg/day)	Less Serious (mg/kg/day)	Serious (mg/kg/day)	
54	Mouse (B6C3F1)	13 wk (W)	Resp	3.83 F			NTP 1994 selenite
			Cardio	3.83 F			
			Gastro	3.83 F			
			Hemato	3.83 F			
			Musc/skel	3.83 F			
			Hepatic	3.83 F			
			Renal	0.91 M	1.61 M (increased relative kidney weight; decreased water intake)		
			Endocr	3.83 F			
			Ocular	3.83 F			
			Bd Wt	1.61 M		3.31 M (body weights 20% lower than controls; decreased water intake)	

Table 3-2 Levels of Significant Exposure to Selenium - Oral

(continued)

Key to figure ^a	Species (Strain)	Exposure/ Duration/ Frequency (Specific Route)	System	LOAEL			Reference Chemical Form
				NOAEL (mg/kg/day)	Less Serious (mg/kg/day)	Serious (mg/kg/day)	
55	Mouse (B6C3F1)	13 wk (W)	Resp	7.17 F			NTP 1994 selenate
			Cardio	7.17 F			
			Gastro	7.17 F			
			Hemato	7.17 F			
			Musc/skel	7.17 F			
			Hepatic	7.17 F			
			Renal	1.07 M	1.87 M (increased kidney weight associated with decreased water intake)		
			Endocr	7.17 F			
			Ocular	7.17 F			
			Bd Wt	1.87	2.95 M (body weights 13% lower than controls; decreased water intake)	5.45 M (body weights 24% lower than controls; decreased water intake)	
56	Mouse (ICR)	30 d 6d/wk (G)	Hepatic	4.7 M	9.4 M (significant 2-3-fold increases in aspartate aminotransferase and alanine aminotransferase)		Sayato et al. 1993 D,L-selenocystine
			Renal	9.4 M			
			Bd Wt		9.4 M (final body weight about 13% lower than controls)	18.9 M (final body weight about 29% lower than controls)	

Table 3-2 Levels of Significant Exposure to Selenium - Oral

(continued)

Key to figure ^a	Species (Strain)	Exposure/ Duration/ Frequency (Specific Route)	System	LOAEL			Reference Chemical Form
				NOAEL (mg/kg/day)	Less Serious (mg/kg/day)	Serious (mg/kg/day)	
57	Mouse Balby	12 wk ad lib (F)	Hepatic		0.2 M (vacuolization of hepatocytes)		Skowerski et al. 1997a sodium selenite
58	Mouse Balby	12 wk ad lib (F)	Cardio		0.2 M (cardiocytes have numerous damaged mitochondria, large number of lipid droplets and numerous lysosomes)		Skowerski et al. 1997b sodium selenite
			Bd Wt	0.2 M			
59	Rabbit (New Zealand)	3 mo ad lib (F)	Cardio			0.137 (disruption of myofibrils, irregular sarcomeres, and disorganization of bands in sarcomeres)	Turan et al. 1999b sodium selenite
			Hemato	0.137			
			Bd Wt	0.137			
60	Pig (mixed breed)	8 wk ad lib (F)	Hepatic		1.1 (vacuolar degeneration, portal fibrosis)		Baker et al. 1989 selenate
			Dermal		1.1 (cracked hoof walls)		
			Bd Wt			1.1 (body weight gain 83% lower than controls, accompanied by decreased food intake)	

Table 3-2 Levels of Significant Exposure to Selenium - Oral

(continued)

Key to figure ^a	Species (Strain)	Exposure/ Duration/ Frequency (Specific Route)	System	LOAEL			Reference Chemical Form
				NOAEL (mg/kg/day)	Less Serious (mg/kg/day)	Serious (mg/kg/day)	
61	Pig (NS)	35 d ad lib (F)	Dermal	0.014	0.25 (hoof cracking)		Mahan and Magee 1991 selenite
			Bd Wt	0.25		0.47 (body weight gain 78% lower than controls, accompanied by decreased food intake)	
62	Pig (crossbred L x Y)	8 wk ad lib (F)	Hepatic	0.33		0.59 (atrophic cirrhosis)	Mihailovic et al. 1992 selenite
			Dermal	0.33	0.59 (hoof cracking, alopecia, redness of skin, petechiae)		
63	Pig (NS)	31 +/- 14 d	Cardio	1.25			Panter et al. 1996 D,L-selenomethionine
			Hepatic	1.25			
			Renal	1.25			
			Dermal		1.25 (symmetrical hair loss, dry scaling skin, cracked overgrown hooves 3/5 pigs)		
			Bd Wt		1.25 (body weight gain 15% less than controls)		

Table 3-2 Levels of Significant Exposure to Selenium - Oral

(continued)

Key to figure ^a	Species (Strain)	Exposure/ Duration/ Frequency (Specific Route)	System	LOAEL			Reference Chemical Form	
				NOAEL (mg/kg/day)	Less Serious (mg/kg/day)	Serious (mg/kg/day)		
64	Pig (NS)	16 +/- 16 d	Resp	1.25			Panter et al. 1996 selenate	
			Cardio	1.25				
			Hepatic	1.25				
			Renal	1.25				
			Dermal		1.25	(symmetrical hair loss, dry scaling skin, cracked overgrown hooves 1/5 pigs)		
			Bd Wt					1.25 (body weight gain 22% less than controls)
65	Pig (NS)	34 d ad lib (F)	Cardio			0.46 (vacuolation, pyknosis of nuclei)	Stowe et al. 1992 NS	
			Musc/skel			0.46 (hyperplasia of sarcolemma nuclei; disintegration of myofibrils)		
66	Pig (Duroc)	NS ad lib (F)	Dermal		0.4 F (2/10 alopecia; 1/10 hoof separation)		Wahlstrom and Olson 1959b selenite	
			Bd Wt	0.4 F				

Table 3-2 Levels of Significant Exposure to Selenium - Oral

(continued)

Key to figure ^a	Species (Strain)	Exposure/ Duration/ Frequency (Specific Route)	System	LOAEL			Reference Chemical Form
				NOAEL (mg/kg/day)	Less Serious (mg/kg/day)	Serious (mg/kg/day)	
67	Cattle Hereford	120 d 1x/d (F)	Resp	0.808 M			O'Toole and Raisbeck 1995 selenomethionine
			Cardio	0.808 M			
			Gastro	0.808 M			
			Musc/skel	0.808 M			
			Hepatic	0.808 M			
			Renal	0.808 M			
			Endocr	0.808 M			
			Dermal	0.158 M	0.288 M (mild parakeratosis of hoof)	0.808 M (severe parakeratosis and epithelial hyperplasia of hoof)	
			Ocular	0.808 M			

Table 3-2 Levels of Significant Exposure to Selenium - Oral

(continued)

Key to figure ^a	Species (Strain)	Exposure/ Duration/ Frequency (Specific Route)	System	LOAEL		Reference Chemical Form	
				NOAEL (mg/kg/day)	Less Serious (mg/kg/day)		Serious (mg/kg/day)
68	Cattle Hereford	120 d 1x/d (F)	Resp	0.808 M			O'Toole and Raisbeck 1995 sodium selenite
			Cardio	0.808 M			
			Gastro	0.808 M			
			Musc/skel	0.808 M			
			Hepatic	0.808 M			
			Renal	0.808 M			
			Endocr	0.808 M			
			Dermal	0.288 M	0.808 M (mild parakeratosis of hoof)		
Ocular	0.808 M						
	Immuno/ Lymphoret						
69	Human	120d (F)		0.004 M			Hawkes et al. 2001 dietary
70	Rat (Sprague- Dawley)	10 wk ad lib (W)			0.7 F (decreased delayed-type hypersensitivity; increased thymus weight)		Koller et al. 1986 selenite
71	Mouse (BALB/c)	47 d ad lib (W)			0.173 (reduced B-cell function and OVA-specific antibody concentration)		Raisbeck et al. 1998 selenocystine

Table 3-2 Levels of Significant Exposure to Selenium - Oral

(continued)

Key to figure ^a	Species (Strain)	Exposure/ Duration/ Frequency (Specific Route)	System	LOAEL		Reference Chemical Form	
				NOAEL (mg/kg/day)	Less Serious (mg/kg/day)		Serious (mg/kg/day)
72	Mouse (BALB/c)	47 d ad lib (W)			0.173	(reduced B-cell function and OVA-specific antibody concentration)	Raisbeck et al. 1998 selenomethionine
73	Mouse (BALB/c)	47 d ad lib (W)			0.173	(reduced OVA-specific antibody concentration)	Raisbeck et al. 1998 sodium selenite
74	Cattle Hereford	120 d 1x/d (F)		0.808 M			O'Toole and Raisbeck 1995 selenomethionine
75	Cattle Hereford	120 d 1x/d (F)		0.808 M			O'Toole and Raisbeck 1995 sodium selenite
Neurological							
76	Human	120 d (F)		0.0048 M			Hawkes and Hornbostel 1996 selenomethionine
77	Monkey (Macaca fascicularis)	30 d 1x/d (GW)		0.08	0.12 F	(hypothermia)	Cukierski et al. 1989 selenomethionine
78	Pig (mixed breed)	7 wk ad lib (F)				1.3	(tetraplegia, poliomyelomalacia) Baker et al. 1989 organic
79	Pig (crossbred L x Y)	8 wk ad lib (F)		0.33		0.59	(hind limb paresis, hind limb ataxia, symmetric poliomyelomalacia of the ventral horn of the spinal cord) Mihailovic et al. 1992 selenite

Table 3-2 Levels of Significant Exposure to Selenium - Oral

(continued)

Key to figure ^a	Species (Strain)	Exposure/ Duration/ Frequency (Specific Route)	System	LOAEL			Reference Chemical Form
				NOAEL (mg/kg/day)	Less Serious (mg/kg/day)	Serious (mg/kg/day)	
80	Pig (NS)	20-42d ad lib (F)		1		2.1 (poliomyelomalacia, paralysis, diffuse gliosis of the spinal cord)	Wilson et al. 1983 selenite
81	Cattle Hereford	120 d 1x/d (F)		0.808 M			O'Toole and Raisbeck 1995 selenomethionine
82	Cattle Hereford	120 d 1x/d (F)		0.808 M			O'Toole and Raisbeck 1995 sodium selenite
Reproductive							
83	Human	102d (F)		0.0039 M			Hawkes and Turek 2001 dietary
84	Monkey (Macaca fascicularis)	30 d 1x/d (GW)		0.06 F	0.08 F (altered menstrual cycle)		Cukierski et al. 1989 selenomethionine
85	Rat (Wild)	5 wk (F)			0.1 M (3.9% abnormal sperm; decrease in live sperm)	0.2 M (24.6% abnormal sperm; decreased live sperm, and sperm motility; decreased testicular weight)	Kaur and Parshad 1994 selenite
86	Rat (Fischer- 344)	13 wk (W)			0.29 M ^b (15% decreased sperm counts)	0.31 F (more time in diestrus and less time in proestrus, estrus, and metestrus than controls)	NTP 1994 selenate

Table 3-2 Levels of Significant Exposure to Selenium - Oral

(continued)

Key to figure ^a	Species (Strain)	Exposure/ Duration/ Frequency (Specific Route)	System	LOAEL			Reference Chemical Form
				NOAEL (mg/kg/day)	Less Serious (mg/kg/day)	Serious (mg/kg/day)	
87	Rat (Fischer- 344)	13 wk (W)		0.5 F	0.17 M ^b (11% decrease epididymal sperm counts) 0.86 F (more time in diestrus and less time in proestrus and estrus)		NTP 1994 selenite
88	Rat (Wistar)	12-14 wk ad lib				0.324 (testicular hypertrophy)	Turan et al. 1999a sodium selenite
89	Mouse (IVCS)	48 d ad lib (W)		0.17 F	0.34 F (proportion of mice with longer estrus cycles increased by 11.8%)		Nobunaga et al. 1979 selenite
90	Mouse (B6C3F1)	13 wk (W)		5.45 M ^b 7.17 F			NTP 1994 selenate
91	Mouse (B6C3F1)	13 wk (W)		3.31 M ^b 3.83 F			NTP 1994 selenite
92	Rabbit (New Zealand)	6 wks 1x/wk (GW)			0.001 M (significant reduction in serum testosterone (49%))		El-Zarkouny et al. 1999 sodium selenite
93	Pig (Duroc)	NS ad lib (F)				0.4 (decreased fertility, maternal toxicity)	Wahlstrom and Olson 1959b selenite

Table 3-2 Levels of Significant Exposure to Selenium - Oral

(continued)

Key to figure ^a	Species (Strain)	Exposure/ Duration/ Frequency/ (Specific Route)	System	LOAEL			Reference Chemical Form
				NOAEL (mg/kg/day)	Less Serious (mg/kg/day)	Serious (mg/kg/day)	
Developmental							
94	Rat (Wistar)	8 wks ad lib (W)			0.64 (decrease weight gain of pups exposed during lactation)		Thorlacius-Ussing 1990 selenite
95	Mouse (IVCS)	pre-Gd:30 d Gd 0-18 ad lib (W)		0.17	0.34 (decreased fetal body weight, delayed vertebral ossification)		Nobunaga et al. 1979 selenite
96	Pig (Duroc)	NS ad lib (F)				0.4 (increased number of deaths between birth and weaning; reduced birth weight and reduced body weight at weaning)	Wahlstrom and Olson 1959b selenite
97	Cattle	3 mo ad lib (F)		0.265			Yaeger et al. 1998 sodium selenite
CHRONIC EXPOSURE							
Death							
98	Rat (Wistar)	2 yr ad lib (F)				0.5 (reduced longevity from about 500 days to about 60-100 days)	Harr et al. 1967; Tinsley et al. 1967 selenate, selenite
Systemic							
99	Human	>3 yr (F)	Endocr	0.01 F			Bratter and Negretti De Bratter 1996 dietary

Table 3-2 Levels of Significant Exposure to Selenium - Oral

(continued)

Key to figure ^a	Species (Strain)	Exposure/ Duration/ Frequency (Specific Route)	System	NOAEL (mg/kg/day)	LOAEL		Reference Chemical Form
					Less Serious (mg/kg/day)	Serious (mg/kg/day)	
100	Human	>2 yr (F)	Hemato	0.0098			Longnecker et al. 1991 organic
			Musc/skel	0.0098			
			Hepatic	0.0098			
			Dermal	0.0098			
101	Human	lifetime (F)	Dermal	0.015 ^c	0.023	(selenosis: sloughing of nails and brittle hair)	Yang and Zhou 1994 Organic
102	Human	yr (F)	Cardio	0.025			Yang et al. 1989a organic
			Hemato	0.015			
			Hepatic	0.025			
			Dermal	0.015			
103	Rat (Wistar)	2 yr ad lib (F)	Musc/skel	0.1	0.2	(soft bones)	Harr et al. 1967; Tinsley et al. 1967 selenite, selenate
			Hepatic	0.025	0.1	(hyperplastic lesions)	
			Renal	0.025	0.1	(nephritis)	

Table 3-2 Levels of Significant Exposure to Selenium - Oral

(continued)

Key to figure ^a	Species (Strain)	Exposure/ Duration/ Frequency (Specific Route)	System	LOAEL		Reference Chemical Form	
				NOAEL (mg/kg/day)	Less Serious (mg/kg/day)		Serious (mg/kg/day)
104	Rat (Osborne- Mendel)	24 mo ad lib (F)	Resp	0.5 F			Nelson et al. 1943 organic
			Gastro	0.5 F			
			Musc/skel	0.5 F			
			Hepatic		0.25 F (slight to moderate cirrhosis)		
			Endocr	0.5 F			
			Dermal	0.5 F			
105	Mouse (Swiss)	lifetime ad lib (W)	Resp			0.57 (amyloidosis)	Schroeder and Mitchener 1972 selenate
			Cardio			0.57 (amyloidosis)	
			Hepatic			0.57 (amyloidosis)	
			Renal			0.57 (amyloidosis)	
			Endocr			0.57 (amyloidosis of adrenal gland)	
			Dermal		0.57 (poor coat)		
			Bd Wt	0.57			

Table 3-2 Levels of Significant Exposure to Selenium - Oral

(continued)

Key to figure ^a	Species (Strain)	Exposure/ Duration/ Frequency (Specific Route)	System	LOAEL			Reference Chemical Form
				NOAEL (mg/kg/day)	Less Serious (mg/kg/day)	Serious (mg/kg/day)	
106	Mouse (Swiss)	lifetime ad lib (W)	Resp			0.57 (amyloidosis)	Schroeder and Mitchener 1972 selenite
			Cardio			0.57 (amyloidosis)	
			Hepatic			0.57 (amyloidosis)	
			Renal			0.57 (amyloidosis)	
			Endocr			0.57 (amyloidosis of adrenal gland)	
			Dermal	0.57	0.57 (poor coat)		
			Bd Wt	0.57			
Neurological							
107	Human	yr (F)		0.027		0.058 (tendon hyperflexia, peripheral anesthesia, pain in extremities, organic polyneuritis)	Yang et al. 1983
Reproductive							
108	Rat (Wistar)	1 yr daily ad lib (W)		0.21	0.35 (50% reduction in number of pups reared in second generation)	1.05 (decreased fertility, pup survival, maternal toxicity; second generation failed to reproduce)	Rosenfeld and Beath 1954 selenate
109	Mouse (CD)	3 gen ad lib (W)				0.57 (failure to breed in the third generation)	Schroeder and Mitchener 1971b selenate

Table 3-2 Levels of Significant Exposure to Selenium - Oral

(continued)

Key to figure ^a	Species (Strain)	Exposure/ Duration/ Frequency (Specific Route)	System	LOAEL			Reference Chemical Form
				NOAEL (mg/kg/day)	Less Serious (mg/kg/day)	Serious (mg/kg/day)	
Developmental							
110	Mouse (CD)	3 gen ad lib (W)				0.57 (increased number of runts; postnatal lethality)	Schroeder and Mitchener 1971b selenate

a The number corresponds to entries in Figure 3-2.

b Differences in levels of health effects and cancer effects between males and females are not indicated in Figure 3-2. Where such differences exist, only the levels of effect for the most sensitive gender are presented.

c Used to derive a chronic oral minimal risk level (MRL) of 0.005 mg/kg-day; The NOAEL is divided by an uncertainty factor of 3 (for human variability).

ad lib = ab libitum; Bd Wt = body weight; Cardio = cardiovascular; CEL = cancer effect level; d = day(s); Endocr = endocrine; (F) = feed; F = female; (G) = gavage; gastro = gastrointestinal; gd = gestation day; GHS-Px = selenium-dependent glutathione peroxidase; (GW) = gavage in water; Hemato = hematological; (IN) = ingestion; LD50 = lethal dose, 50% kill; LOAEL = lowest-observed-adverse-effect level; LPS = lipopolysaccharide; M = male; metab = metabolic; mg/kg/day = milligram per kilogram per day; mo = month(s); Musc/skel = musculoskeletal; NOAEL = no-observed-adverse-effect level; (NS) = not specified; Resp = respiratory; TNF = tumor necrosis factor; TSH = thyroid-stimulating hormone; (W) = water; wk = week(s); x=time(s); yr = year(s)

Figure 3-2. Levels of Significant Exposure to Selenium - Oral
Acute (≤ 14 days)

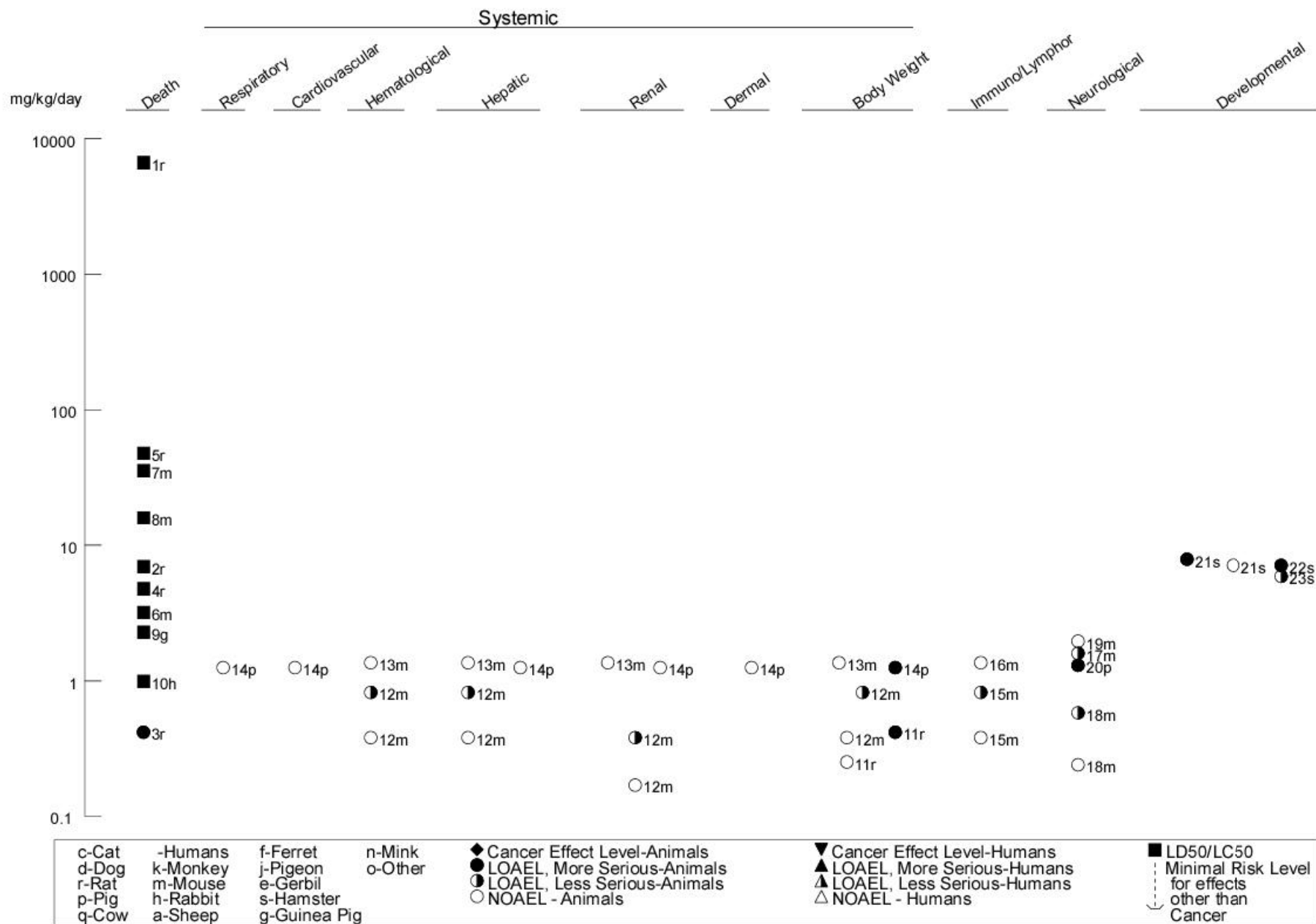
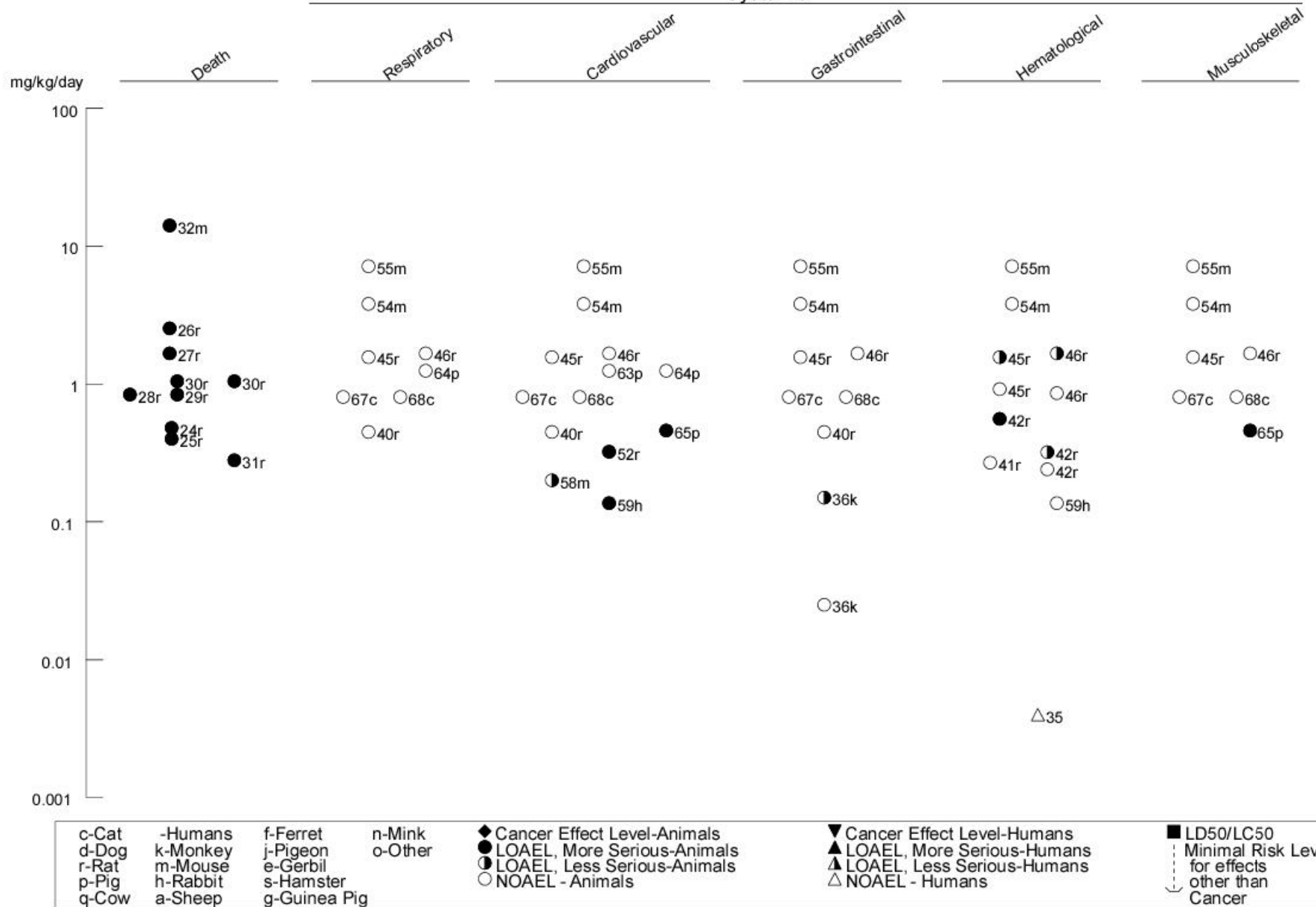

Figure 3-2. Levels of Significant Exposure to Selenium - Oral (continued)

Intermediate (15-364 days)

Systemic



c-Cat	-Humans	f-Ferret	n-Mink	◆ Cancer Effect Level-Animals	▼ Cancer Effect Level-Humans	■ LD50/LC50
d-Dog	k-Monkey	j-Pigeon	o-Other	● LOAEL, More Serious-Animals	▲ LOAEL, More Serious-Humans	⋮ Minimal Risk Level
r-Rat	m-Mouse	e-Gerbil		○ LOAEL, Less Serious-Animals	△ LOAEL, Less Serious-Humans	for effects
p-Pig	h-Rabbit	s-Hamster		○ NOAEL - Animals	△ NOAEL - Humans	other than
q-Cow	a-Sheep	g-Guinea Pig				Cancer

Figure 3-2. Levels of Significant Exposure to Selenium - Oral (continued)
Intermediate (15-364 days)

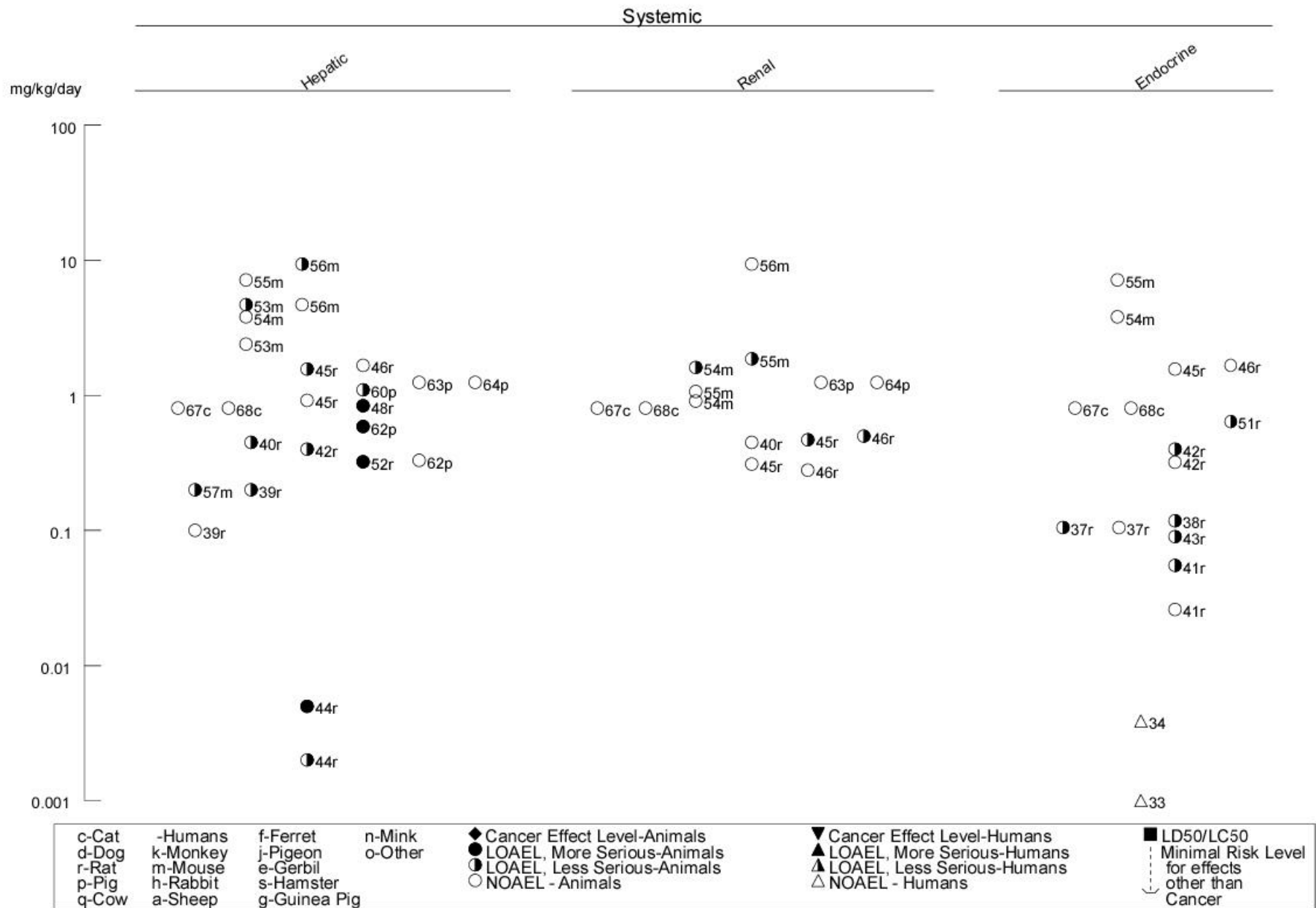

Figure 3-2. Levels of Significant Exposure to Selenium - Oral (*continued*)
Intermediate (15-364 days)

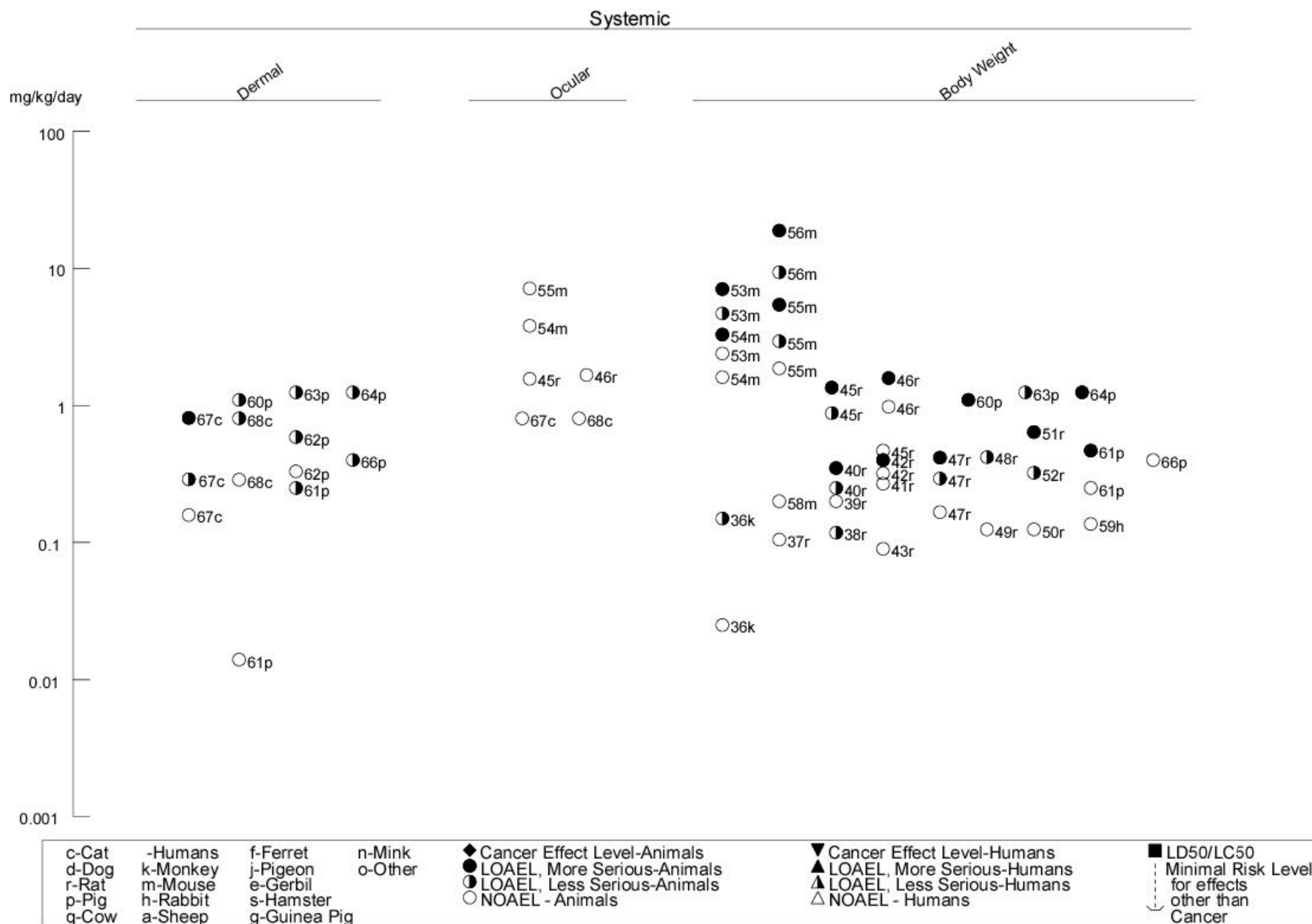

Figure 3-2. Levels of Significant Exposure to Selenium - Oral (continued)

Intermediate (15-364 days)

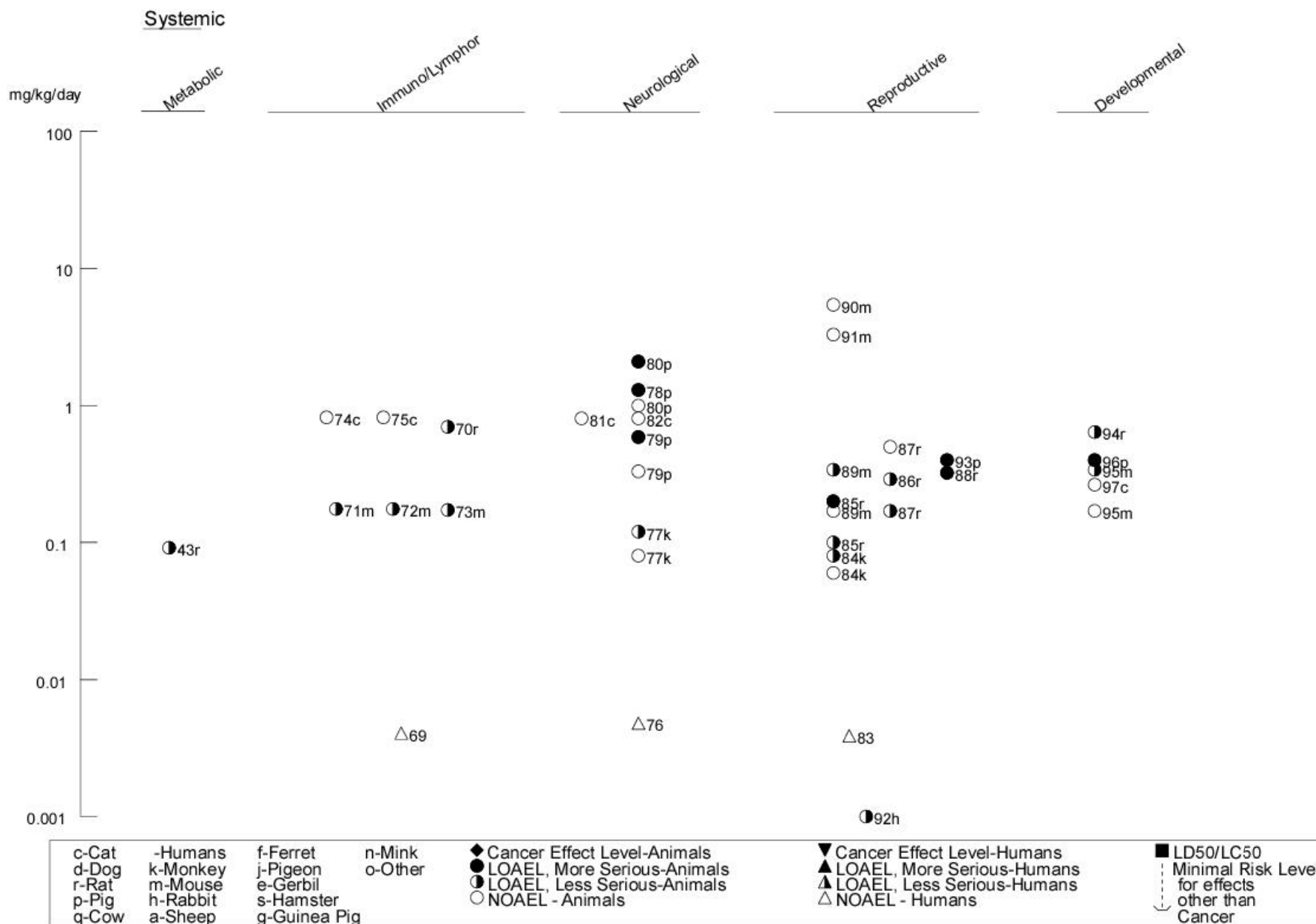

Figure 3-2. Levels of Significant Exposure to Selenium - Oral (continued)
Chronic (≥ 365 days)

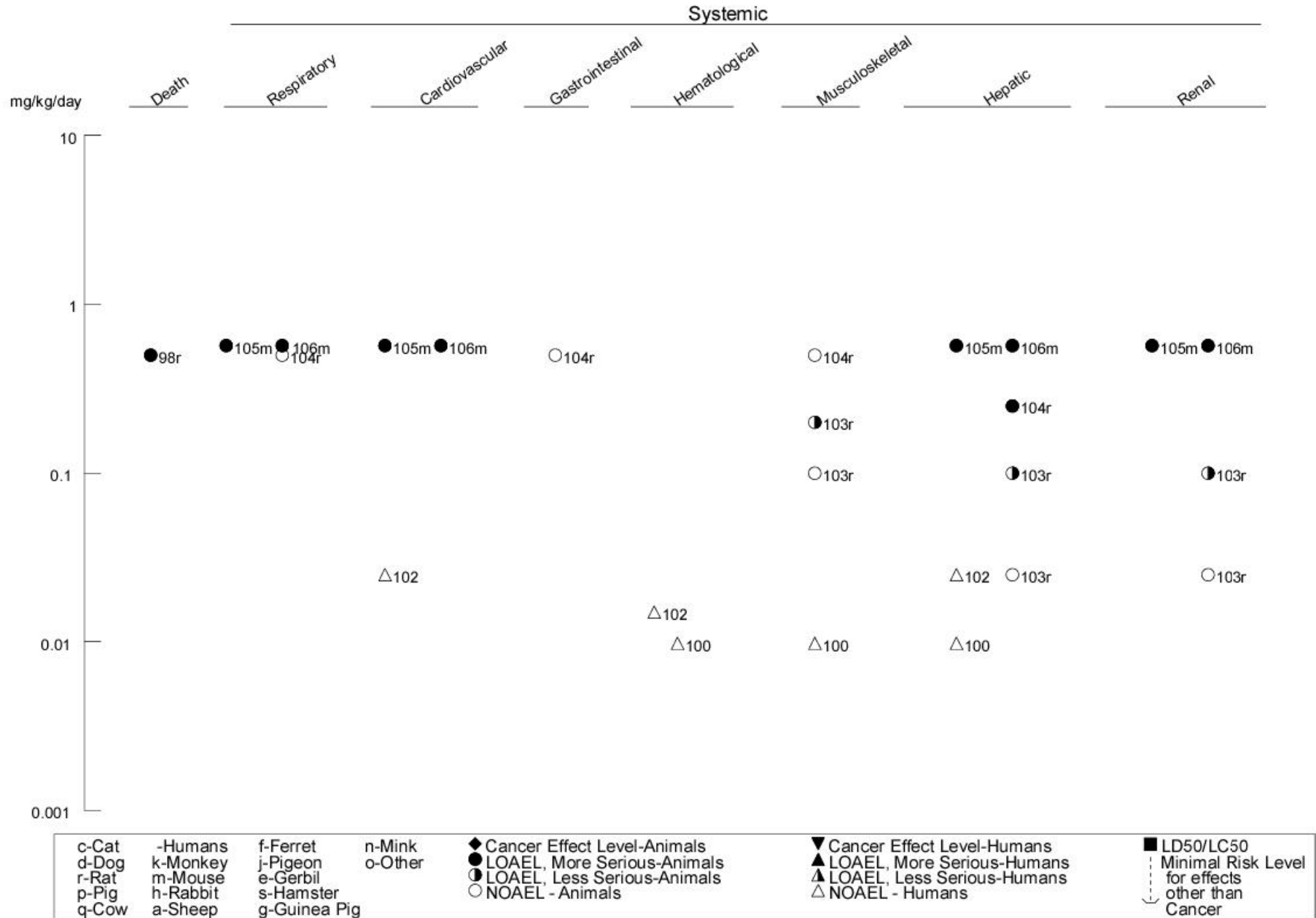

Figure 3-2. Levels of Significant Exposure to Selenium - Oral (continued)

Chronic (≥365 days)

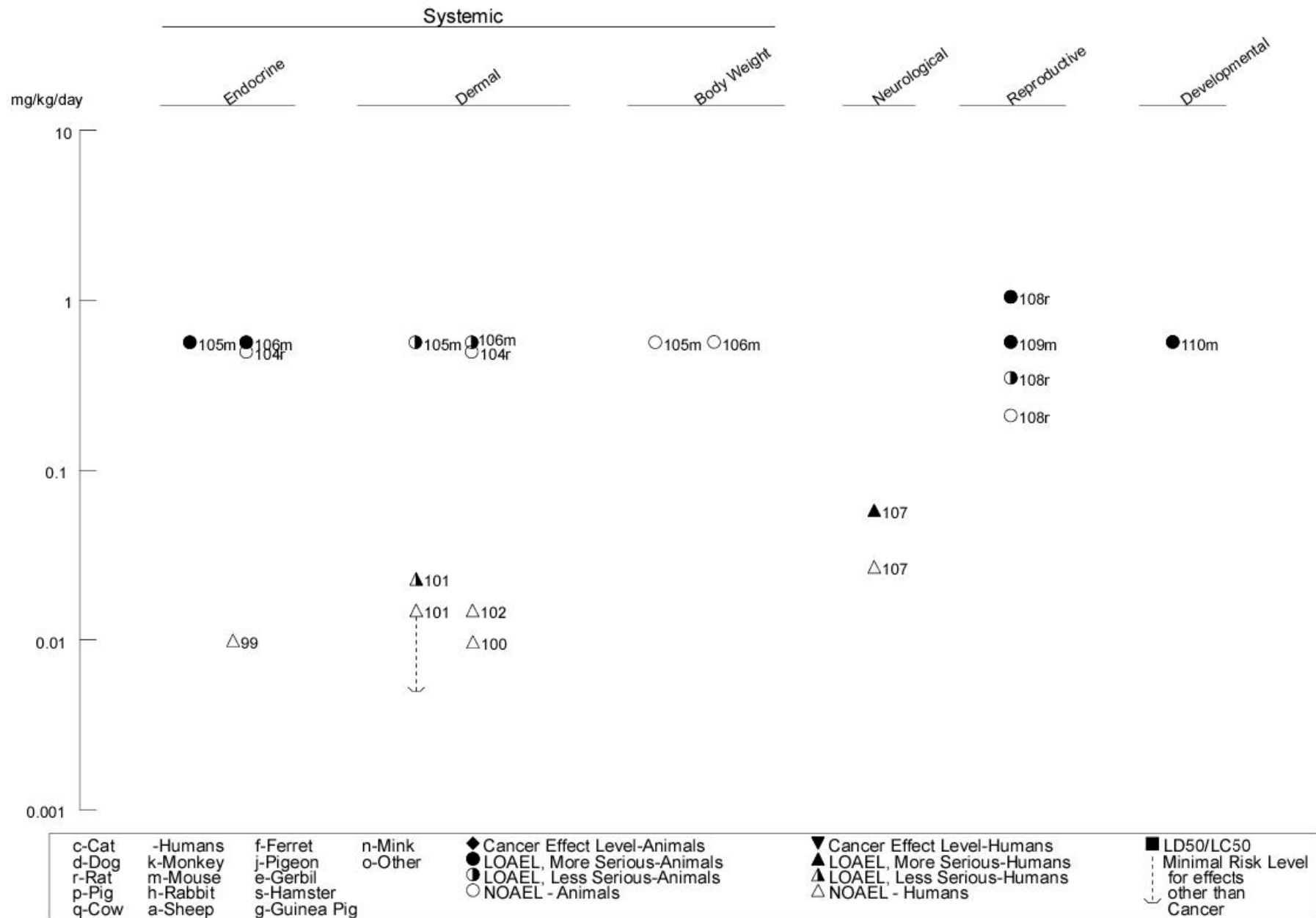

Table 3-3 Levels of Significant Exposure to Selenium Sulfides - Oral

Key to figure ^a	Species (Strain)	Exposure/ Duration/ Frequency (Specific Route)	System	LOAEL			Reference Chemical Form
				NOAEL (mg/kg/day)	Less Serious (mg/kg/day)	Serious (mg/kg/day)	
ACUTE EXPOSURE							
Death							
1	Rat (Sprague- Dawley)	once (G)				138 M (LD50)	Cummins and Kimura 1971 SeS2 (aqueous)
2	Rat (Wistar)	once (GO)				75 M (3/6 died)	Moore et al. 1996b SeS
3	Rat (Wistar)	once (GO)				50 (3/15 died)	Moore et al. 1996b SeS
4	Mouse (NMRI)	once (G)				3700 (LD50)	Henschler and Kirschner 1969 SeS
Systemic							
5	Rat (Wistar)	once (GO)	Hepatic			75 M (widespread hepatic necrosis)	Moore et al. 1996b SeS
INTERMEDIATE EXPOSURE							
Death							
6	Rat (Fischer- 344)	17 d 1x/d (G)				112 M (LD50) ^b 56 F (LD50)	NTP 1980c SeS, SeS2
7	Mouse (B6C3F1)	17 d 1x/d (G)				805 M (LD50) ^b 316 F (LD50)	NTP 1980c SeS, SeS2

Table 3-3 Levels of Significant Exposure to Selenium Sulfides - Oral

(continued)

Key to figure ^a	Species (Strain)	Exposure/ Duration/ Frequency (Specific Route)	System	LOAEL		Reference Chemical Form
				NOAEL (mg/kg/day)	Less Serious (mg/kg/day)	
Systemic						
8	Rat (Fischer- 344)	13 wk 7d/wk 1x/d (G)	Resp	31.6		NTP 1980c SeS, SeS2
			Cardio	31.6		
			Gastro	31.6		
			Musc/skel	31.6		
			Hepatic	17.6	31.6 (focal necrosis)	
			Renal	31.6		
			Endocr	31.6		
			Dermal	31.6		
			Bd Wt	31.6		

Table 3-3 Levels of Significant Exposure to Selenium Sulfides - Oral

(continued)

Key to figure ^a	Species (Strain)	Exposure/ Duration/ Frequency (Specific Route)	System	LOAEL			Reference Chemical Form
				NOAEL (mg/kg/day)	Less Serious (mg/kg/day)	Serious (mg/kg/day)	
9	Mouse (B6C3F1) (G)	13 wk 7d/wk 1x/d	Resp	464			NTP 1980c SeS, SeS2
			Cardio	464			
			Gastro	464			
			Musc/skel	464			
			Hepatic	464			
			Renal	216	464	(interstitial nephritis)	
			Endocr	464			
			Dermal	464			
			Bd Wt	216 F	464 F	(body weight 17% lower than controls)	
CHRONIC EXPOSURE							
Cancer							
10	Rat (Fischer- 344) (G)	103 wk 7d/wk 1x/d					NTP 1980c SeS, SeS2
						15 (hepatocellular carcinomas 14/49 males, 21/50 females)	

Table 3-3 Levels of Significant Exposure to Selenium Sulfides - Oral

(continued)

Key to figure ^a	Species (Strain)	Exposure/ Duration/ Frequency (Specific Route)	System	LOAEL			Reference Chemical Form
				NOAEL (mg/kg/day)	Less Serious (mg/kg/day)	Serious (mg/kg/day)	
11	Mouse (B6C3F1)	103 wk 7d/wk 1x/d (G)				100 F (hepatocellular carcinomas/adenomas 25/49, alveolar/bronchiolar carcinoma/adenomas 12/49)	NTP 1980c SeS, SeS2

a The number corresponds to entries in Figure 3-3.

b Differences in levels of health effects and cancer effects between males and females are not indicated in Figure 3-3. Where such differences exist, only the levels of effect for the most sensitive gender are presented.

ad lib = ab libitum; Bd Wt = body weight; Cardio = cardiovascular; CEL = cancer effect level; d = day(s); Endocr - endocrine; F = female; gastro = gastrointestinal; (G) = gavage; gd = gestation day; Hemato = hematological; LOAEL = lowest-observed-adverse-effect level; M = male; Metab = metabolic; Musc/skel = musculoskeletal; NOAEL = no-observed-adverse-effect level; Resp = respiratory; (W) = water; wk = week(s); x = time(s); yr = year(s)

Figure 3-3. Levels of Significant Exposure to Selenium Sulfides - Oral
Acute (≤ 14 days)

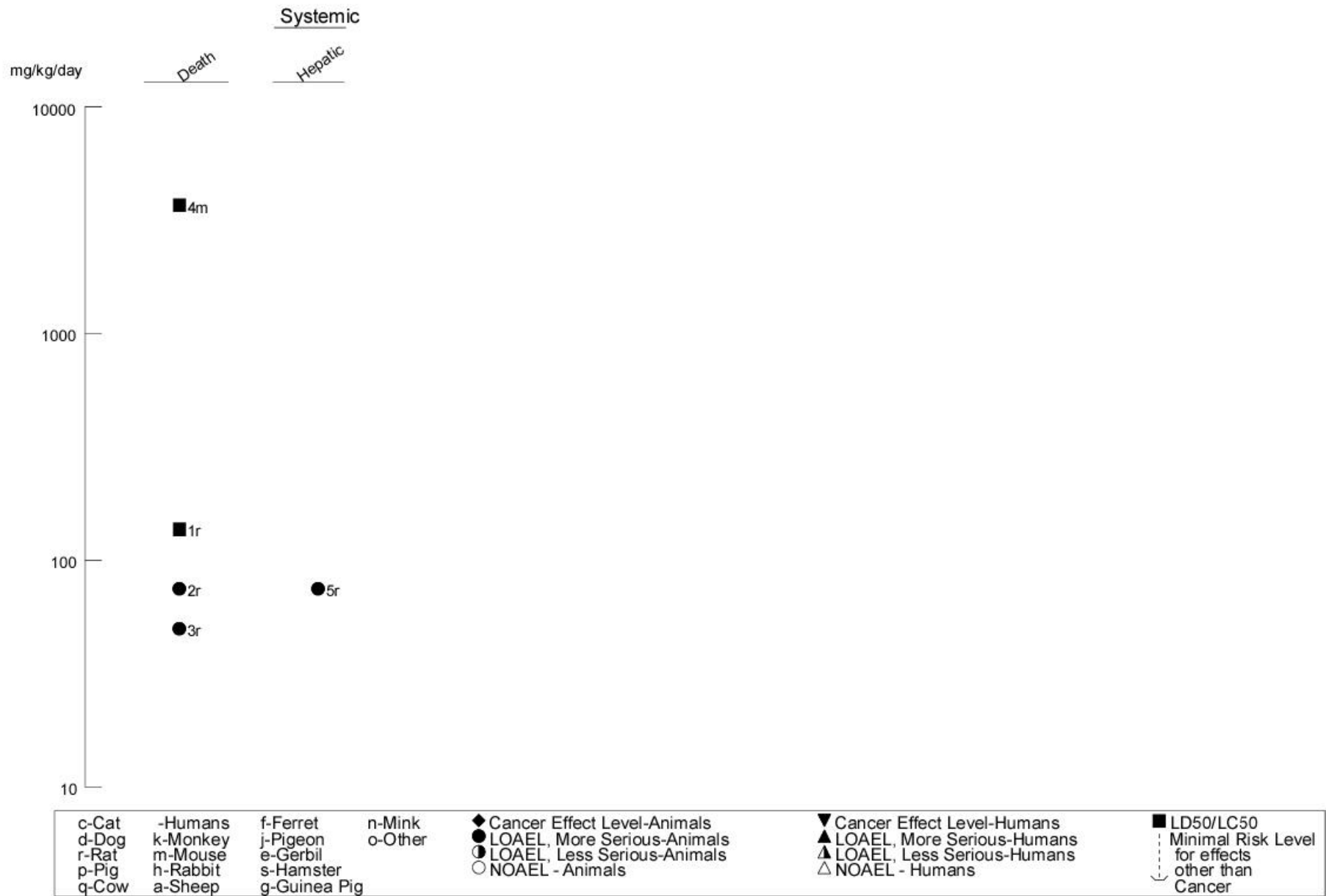

Figure 3-3. Levels of Significant Exposure to Selenium Sulfides - Oral (continued)

Intermediate (15-364 days)

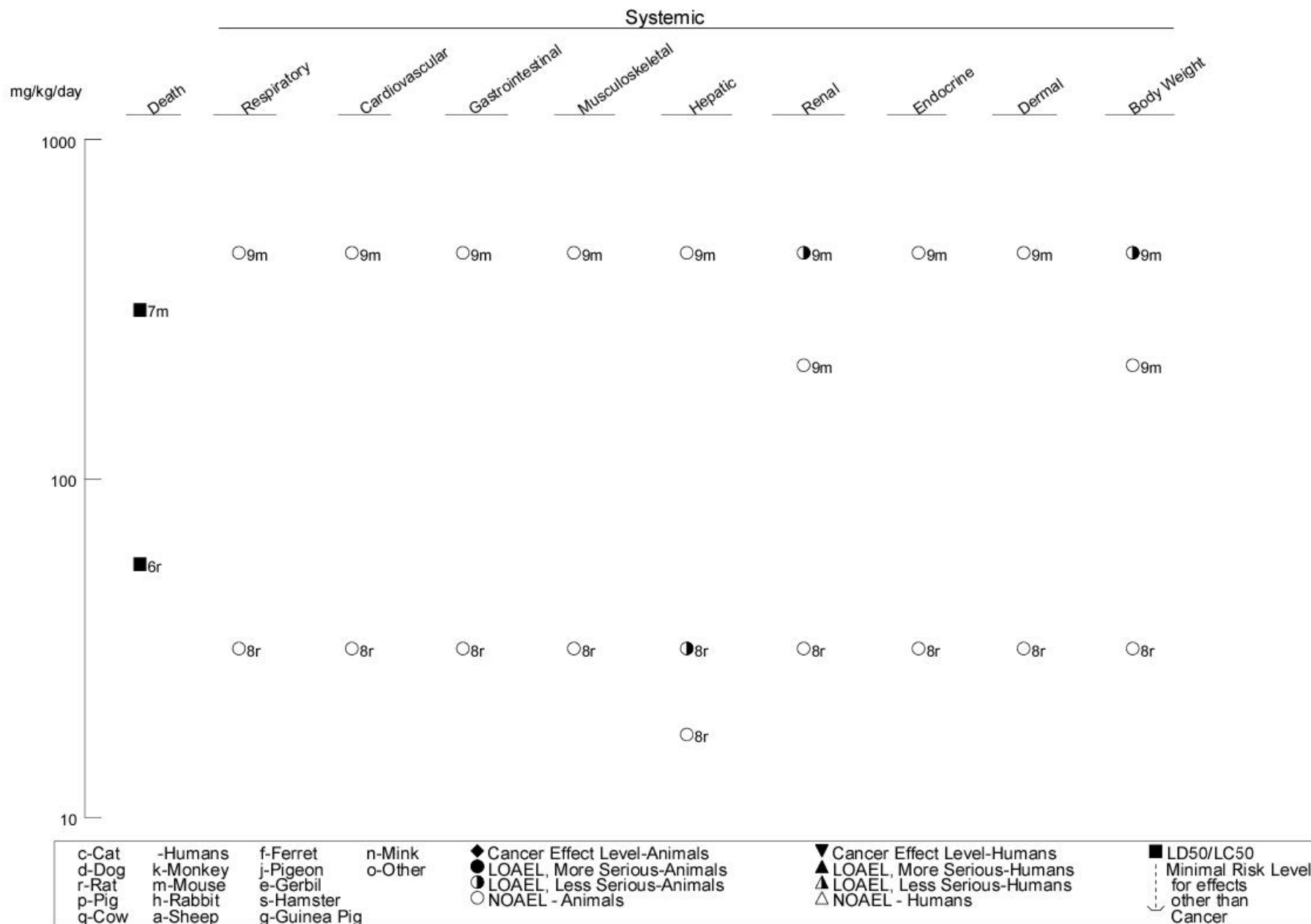
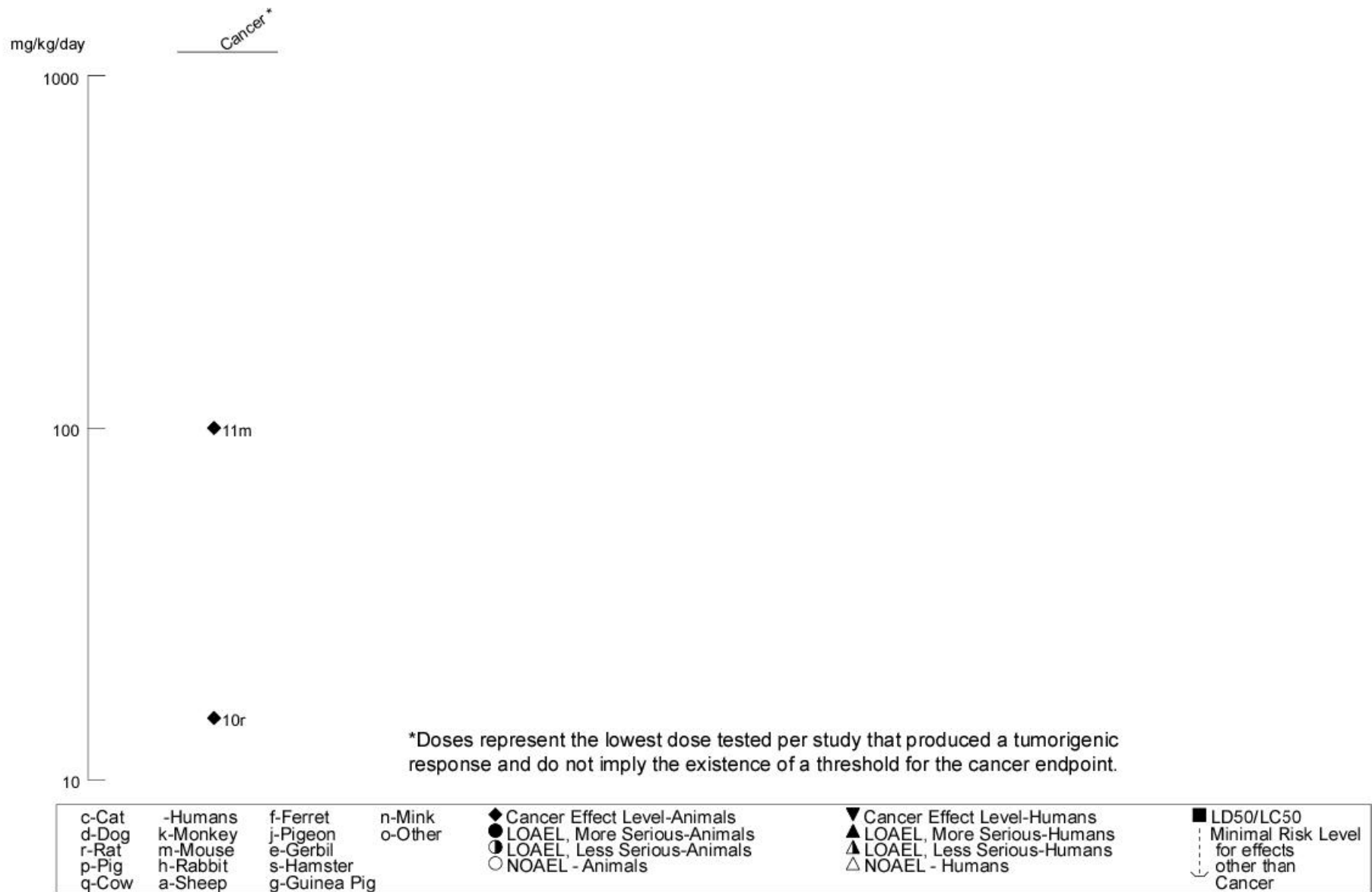

Figure 3-3. Levels of Significant Exposure to Selenium Sulfides - Oral (*continued*)
 Chronic (≥ 365 days)



3. HEALTH EFFECTS

of the compound, because selenium sulfide preparations often exist as a variable mixture of the mono- and disulfide forms, precluding accurate expression of the dose in terms of total selenium.

Most of the available toxicity information for oral exposures to selenium compounds comes from domestic or experimental animal exposures to selenite, selenate, selenium sulfides (mixed), and organic selenium compounds (selenocystine, selenomethionine). Some of the earliest recognized effects of selenium were observed in livestock (cattle, sheep, and horses) that grazed on plants in areas of South Dakota, where soil selenium concentrations are naturally high. Selenium-associated effects observed in livestock include “blind staggers” and alkali disease. “Blind staggers” is an acute syndrome in which there is usually a slight impairment of vision, which can result in the animal straying from the herd. As the disease progresses, the blindness becomes more pronounced, and the animal may wander in circles. In the last stage, there are various degrees of paralysis and evidence of abdominal pain; death results from respiratory failure. However, because the effects have not been replicated in experimentally exposed cattle receiving doses of selenium sufficient to induce hoof lesions, the neurological signs associated with “blind staggers” may be due to compounds other than selenium in the vegetation. Alkali disease is a chronic disease in which the animals become emaciated, stiff, and lame; lose long hair from the mane and the tail; and the hooves become deformed. Alkali disease is also associated with atrophy of the heart and liver, while congestion and focal necrosis of the liver are more prominent in “blind staggers”.

Some epidemiological studies report data from populations exposed to selenium in the food chain in areas with high selenium levels in soil. It is likely that selenite, selenate, and the selenium found in food and in dietary supplements comprise the majority of selenium compounds to which oral, off-site selenium exposures will occur at or near hazardous waste sites. Aside from the variation in effective dose, the health effects from exposure to selenate, selenite, and dietary selenium are not expected to differ greatly. However, oral exposures to many other compounds of selenium could occur (primarily through soil or edible plant ingestion) if those compounds were deposited at the site, or if local environmental conditions greatly favor transformation to those forms. Heavy metal selenides, aluminum selenide, tungsten diselenides, and cadmium selenide are used in industry and may end up in waste sites. Mobilization of selenium, typically as selenate in water run-off, has the potential to impact nearby plants and animals, thus potentially exposing people through eating game meat, local plants, and agricultural or livestock food products from the area.

3. HEALTH EFFECTS

3.2.2.1 Death

Accidental selenium poisonings in humans have occurred, but few fatalities have been reported. The selenium doses associated with the reported deaths are unknown (Carter 1966; Koppel et al. 1986). One 3-year-old boy died 1.5 hours after ingestion of an unknown quantity of selenious acid contained in a gun-bluing preparation (Carter 1966). Clinical signs included excessive salivation, garlic odor on the breath, and shallow breathing. A 15-year-old female survived ingestion of a solution of sodium selenate estimated to have provided 22 mg selenium/kg body weight, probably because she was forced to vomit soon after exposure (Civil and McDonald 1978). Clinical signs included garlic odor of the breath and diarrhea.

No cases of human death in the United States have been attributed to intermediate or chronic oral exposures to selenium or selenium compounds. In the Hubei Province of China, in an area of endemic selenosis, a woman who died was suffering from hemiplegia thought to have been caused by chronic selenosis induced by eating locally grown foods that contained high levels of organic selenium compounds (Yang et al. 1983). However, an autopsy was not performed and no clinical history of previous illness was available.

In nonhuman animals, the most acutely toxic selenium compounds by ingestion appear to be sodium selenite and sodium selenate (Olson 1986). Oral LD₅₀ values for sodium selenite, expressed as mg selenium/kg body weight, were reported as 4.8–7.0 in rats, 1.0 in rabbits, 3.2 in mice, and 2.3 in guinea pigs (Cummins and Kimura 1971; Pletnikova 1970). Minimum lethal doses of sodium selenite, expressed as mg selenium/kg body weight, reported for larger animals were 13–18 for pigs and 9.9–11.0 for cows (Miller and Williams 1940); however, these values were estimated on the basis of a small number of animals. Two of four 12-week-old lambs died within 16 hours of administration of 5 mg selenium/kg as sodium selenite (Smyth et al. 1990). Selenium dioxide is reported to have LD₅₀ values of 16 mg selenium/kg for mice and 48 mg selenium/kg body weight for rats, but these values are also based on a small number of animals (Singh and Junnarkar 1991). An oral LD₅₀ of 35.9 mg selenium/kg has been reported for L-selenocystine given to mice (Sayato et al. 1993). Elemental selenium is less toxic than most selenium compounds, because of its extremely low solubility; an LD₅₀ of 6,700 mg selenium/kg body weight has been reported for oral administration of elemental selenium as a suspension (particle size 1–30 µm) in 0.5% methylcellulose to rats (Cummins and Kumura 1971).

3. HEALTH EFFECTS

Lower doses of selenium can cause signs of toxicity if administered over extended periods of time. Eight weaned 5-week-old pigs receiving 1.3 mg selenium/kg/day as sodium selenite in gelatin capsules daily for 10 days died during one study; only one dose level was tested (Wilson et al. 1989). Two long-tailed macaques administered 0.60 mg selenium/kg/day as selenomethionine by nasogastric intubation died of either anorexia or aspirated vomitus secondary to emesis and gastritis after 10 or 15 days of treatment (Cukerski et al. 1989). Seven of 12 female rats receiving diets containing 0.418 mg selenium/kg/day as sodium selenate for 14 days died before the end of the experiment (NTP 1996). Exposure to selenium in drinking water at a level of 0.84 mg selenium/kg/day as selenite or selenate for 4–6 weeks resulted in the death of four of six or two of six male rats, respectively (Palmer and Olson 1974). Feeding male rats diets containing 0.48 mg selenium/kg/day as sodium selenite or 0.4 mg selenium/kg/day as seleniferous wheat for 6 weeks resulted in the death of one of eight rats in each group (Halverson et al. 1966). Administration of sodium selenite in drinking water at a level of 0.28 mg selenium/kg/day for 58 days resulted in the death of 25 of 50 male rats (Schroeder and Mitchener 1971a). Mortality was observed in rats, but not in mice, receiving either 1.67 mg selenium/kg/day as sodium selenite or 2.54 mg selenium/kg/day as sodium selenate in drinking water for 13 weeks (NTP 1994). Gavage treatment of male mice with selenocystine 6 days per week for 30 days at a dose of 14.2 mg selenium/kg killed all 15 treated animals, while no deaths were noted at 9.4 mg selenium/kg (Sayato et al. 1993). The longevity of hamsters was not affected by dietary administration of sodium selenite at a dose of 0.42 mg selenium/kg/day for 124–144 weeks (Birt et al. 1986).

Sodium selenate and sodium selenite exhibit similar toxicity in female rats, but male rats appear more susceptible to the toxicity of sodium selenite than selenate (Palmer and Olson 1974; Schroeder and Mitchener 1971a). Sodium selenate in drinking water at 0.28 selenium mg/kg/day for 1 year did not increase mortality of male or female rats compared with control rats (Schroeder and Mitchener 1971a). Ingestion of 0.28 mg selenium/kg/day of sodium selenite in drinking water for 1 year did not increase mortality in female rats, whereas 50% of the males died by day 58 of administration (Schroeder and Mitchener 1971a).

The relative acute toxicities of sodium selenite, potassium selenite, sodium selenate, and potassium selenate in aqueous solution have been examined in mice (Pletnikova 1970). No significant differences among the toxicities of the potassium and sodium salts of selenium were apparent in this study. In another study, rats tolerated a dose of 1.05 mg selenium/kg/day administered in drinking water as potassium selenate for over 8 months with no deaths, but three of five females and one of three males died by the end of 1 year (Rosenfeld and Beath 1954). Decreased survival was reported in rats fed sodium

3. HEALTH EFFECTS

selenate or selenite at 0.5 mg selenium/kg/day in a 2-year cancer study (Harr et al. 1967; Tinsley et al. 1967). No mortality was observed in hamsters fed 0.42 mg selenium/kg/day as sodium selenite in the diet for 82–142 weeks (Birt et al. 1986).

Selenium sulfide (i.e., selenium monosulfide) and selenium disulfide are less water soluble and are of lower acute toxicity than sodium selenate or sodium selenite. There are no reported human deaths due to ingestion of selenium sulfide. The LD₅₀ value for the gavage administration of 1–20% selenium disulfide in aqueous 0.5% methylcellulose to rats was 138 mg selenium disulfide/kg (Cummins and Kimura 1971). When 1% selenium disulfide shampoo was administered by gavage, the LD₅₀ value was lower (78 mg selenium disulfide/kg) (Cummins and Kimura 1971). The compound administered may have been a mixture of selenium sulfide and selenium disulfide; analysis of the compound was not reported. Henschler and Kirschner (1969) reported an LD₅₀ of 3,700 mg selenium sulfide/kg for mice administered by gavage in aqueous 0.5% carboxymethylcellulose. Administration of single gavage doses of selenium monosulfide to rats produced death in 3/15 animals dosed with 50 mg/kg, 3/6 animals dosed with 75 mg/kg, 1/2 animals dosed with 100 mg/kg, and 2/2 animals dosed with 125 mg/kg (Moore et al. 1996b).

In the case of selenium sulfide, mice are more tolerant than rats, and males of both species appear to be more tolerant than females (NTP 1980c). The daily doses producing 50% mortality for a 17-day gavage administration of a mixture of selenium mono- and disulfides were 112 mg selenium sulfides/kg for male rats, 56 mg selenium sulfides/kg for female rats, and 805 mg selenium sulfides/kg for male mice (NTP 1980c). A 13-week gavage study using the same mixture of selenium mono- and disulfides reported survival as 10/10, 10/10, 10/10, 9/9, 8/9, and 6/10 in female mice and 10/10, 10/10, 10/10, 10/10, 10/10, and 9/10 in male mice receiving 0, 21.6, 46.4, 100, 216, and 464 mg selenium sulfides/kg/day, respectively (NTP 1980c). Although the researchers intended to administer selenium monosulfide to the animals, elemental analysis, melting point, and x-ray diffraction revealed that the compound administered included some selenium disulfide. No other chemical or physical analyses of the selenium compound administered were reported.

The LD₅₀ and lethal LOAEL values from each reliable study following oral exposure to elemental selenium dust, selenium dioxide dissolved in water (selenious acid), sodium selenate, sodium selenite, potassium selenate, and dietary selenium for each species and exposure duration are recorded in Table 3-2 and plotted in Figure 3-2. The LOAEL values for death in rats and mice following acute and intermediate

3. HEALTH EFFECTS

oral exposures to selenium sulfide or selenium disulfide are recorded in Table 3-3 and plotted in Figure 3-3.

3.2.2.2 Systemic Effects

The highest NOAEL value and all LOAEL values for each reliable study for systemic effects in each species and duration category are recorded in Tables 3-2 and 3-3 and plotted in Figures 3-2 and 3-3.

Respiratory Effects. Pulmonary edema and lesions of the lung have been noted in case reports of humans (Carter 1966; Koppel et al. 1986) and animals (Glenn et al. 1964a; Rosenfeld and Beath 1947) after ingestion of lethal doses of selenium compounds. Rabbits orally administered sodium selenite (subroute not specified) at levels approximating the LD₅₀ (1–5 mg selenium/kg body weight) developed pulmonary congestion, hemorrhages, and edema; dyspnea; general muscular weakness; and asphyxial convulsions (Smith and Westfall 1937). Pulmonary edema and hemorrhages were observed in four sheep treated orally (subroute not specified) with a single dose of sodium selenite of 5 mg selenium/kg (Smyth et al. 1990). The lungs may be a target of acute exposure to excess selenium because the metabolite, dimethyl selenide, is exhaled.

The effects of intermediate or chronic exposures to selenium compounds are less clear. Although Harr et al. (1967) stated that absolute lung weights decreased with increasing doses of selenite or selenate chronically administered to rats in the diet in a 2-year cancer study, they did not report lung weights at specific dose levels. Selenium administration also might have contributed to pneumonic lesions, but again, the authors did not statistically analyze their results or relate the severity of the effect to the doses of selenium administered. Respiratory effects were not observed in rats treated with selenite in the diet for 8 weeks at a dose of 0.45 mg selenium/kg/day (Chen et al. 1993). Effects on the lungs were not observed in pigs fed 1.25 mg selenium/kg as organic selenium found in the plant *Astragalus bisulcatus* for up to 5 days, or D,L-selenomethionine or selenate in the diet for up to 6 weeks (Panter et al. 1996). Treatment of steers with selenomethionine or selenite in food at doses up to 0.808 mg selenium/kg/day for 120 days did not produce any signs of respiratory distress or changes in lung weight or histology (O'Toole and Raisbeck 1995). Ingestion of selenium in drinking water for 13 weeks at doses up to 1.67 and 7.17 mg selenium/kg as selenate in rats and mice, respectively, and 1.57 and 3.83 mg selenium/kg as selenite in rats and mice, respectively, did not cause any respiratory effects (NTP 1994). Nelson et al. (1943) reported that no effects on the lungs were apparent in rats administered 0.50 mg selenium/kg/day as seleniferous corn for 2 years.

3. HEALTH EFFECTS

An increased incidence of amyloidosis of the major organs, including the lungs, was observed in mice following lifetime exposure to sodium selenate or sodium selenite in drinking water at a level of 0.57 mg selenium/kg/day (Schroeder and Mitchener 1972). This effect was noted in 30% of control mice and 58% ($p < 0.001$) of selenium-treated mice. Data for individual organs were not provided.

Administration of lethal doses of selenium sulfide particles in carboxymethylcellulose by gavage has been reported to cause irregular breathing in mice (Henschler and Kerschner 1969), but not in rats (Cummins and Kimura 1971). No respiratory effects were seen in mice administered 464 mg selenium sulfides/kg/day or in rats administered 31.6 mg selenium sulfides/kg/day by gavage once daily for 13 weeks (NTP 1980c).

Cardiovascular Effects. Tachycardia has occasionally been reported as a result of a lethal, acute oral exposure to selenium compounds in humans (Carter 1966); however, the dose was not reported in this lethal exposure to a gun-bluing solution containing selenious acid. Although myocardial disorders (cardiogenic shock, congestive heart failure, arrhythmia, multifocal necrosis of the myocardium) have been associated with selenium deficiencies (Yang et al. 1988), none has been reported to be associated with chronic dietary selenosis in humans observed at doses of ≥ 0.016 mg/kg/day (Yang et al. 1989a). A preliminary study completed in China suggests that selenium supplementation (100 μ g/day, form not stated) during pregnancy may reduce the incidence of pregnancy-induced hypertension (Li and Shi-mei 1994).

In contrast, postmortem studies of sheep that died from acute oral exposure to sodium selenite or sodium selenate have revealed petechial hemorrhages of the endocardium (Glenn et al. 1964a; Smyth et al. 1990). The sheep were treated with a time-weighted average dose of 0.65 or 0.9 mg selenium/kg/day as selenate over a 171-day period (Glenn et al. 1964a, 1964b), or a single dose of selenite at 5 mg selenium/kg (Smyth et al. 1990). Vacuolation and pyknosis of nuclei were observed in the hearts of pigs fed an unspecified form of selenium at a dose of 0.46 mg selenium/kg/day for 34 days (Stowe et al. 1992). In a 2-year cancer study, Harr et al. (1967) reported the occurrence of myocardial hyperemia, hemorrhage, and degeneration, as well as pericardial edema, in young rats administered sodium selenite or sodium selenate in the feed at doses of 0.5 mg selenium/kg/day, although the authors did not specify the duration of exposure required to produce the effects.

3. HEALTH EFFECTS

Exposure of pigs to feed containing 54 mg/kg selenium for 1–7 days resulted in severe toxicity and death of several of the animals (Penrith and Robinson 1996). Histological examination of heart tissue from pigs that died revealed myocardial lesions consisting of widespread hypertrophy, atrophy, and disorganization of fibers, occasional fibrosis, and marked medial hypertrophy of the arterioles.

Wistar rats administered 0.324 mg selenium/kg/day as sodium selenite in food for 12–14 weeks showed severe diffuse degenerative changes, including edema in the sub-endocardial connective tissue and the interfibers of prevascular regions, and myofibril swelling with profuse intercellular edema (Turan et al. 1999a). Myocyte borders were irregular, and there was a loss of striations and a degeneration of the sarcolemma and myofibril structure and order. Examination of the mechanical function of the heart *in vitro* using either Langendorff perfusion or papillary muscle recordings showed increased coronary perfusion pressure, increased resting force, and increased heart rate with irregular beating. No difference in contractile force was observed. Chronic heart failure did not occur in any of the animals in the study.

Cardiac damage was also observed in mice exposed to 0.2 mg selenium/kg/day as sodium selenite in food for 12 weeks (Skowerski et al. 1997b). Ultrastructural examination revealed cardiomyocytes that had numerous damaged mitochondria, a large number of lipid droplets, and numerous lysosomes.

Hearts of New Zealand white rabbits administered 0.137 mg selenium/kg/day as sodium selenite in food for 3 months showed distinct, degenerative changes indicating disintegration of the internal structure of the myocytes (Turan et al. 1999b). Muscle fibers were fragmented and separated. Disruption and loss of myofibrils was observed, sarcomeres were irregular, and the I, Z, and H bands were disorganized and discontinuous. Mitochondria were fewer and more variable in size and shape, with disoriented cristae and a loss of matrix substance. Hearts of control animals (0.007 mg selenium/kg/day) had normal histology.

Treatment of steers with selenomethionine or selenite in food at doses up to 0.808 mg selenium/kg/day for 120 days did not produce any changes in heart weight or histology (O'Toole and Raisbeck 1995). Histopathological changes in the heart were not observed in pigs fed selenium at 1.25 mg selenium/kg as organic selenium found in the plant *A. bisulcatus* for up to 5 days, or D,L-selenomethionine or selenate for up to 6 weeks (Panter et al. 1996). Histopathological changes were not observed in the hearts of rats treated with selenite in the diet for 8 weeks at a dose of 0.45 mg selenium/kg/day (Chen et al. 1993). Selenium administered to rats and mice in drinking water for 13 weeks at doses up to 1.57 and 7.17 mg selenium/kg/day as selenate, respectively, and up to 1.67 and 3.83 mg selenium/kg/day as selenite, respectively, did not cause any histopathological changes in the heart tissue (NTP 1994). No

3. HEALTH EFFECTS

histopathological changes were noted in mice administered 464 mg selenium sulfides/kg/day or in rats administered 31.6 mg selenium sulfides/kg/day by gavage once daily for 13 weeks (NTP 1980c).

An increased incidence of amyloidosis of the major organs, including the heart, was observed in mice following lifetime exposure to sodium selenate or sodium selenite in drinking water at a level of 0.57 mg selenium/kg/day (Schroeder and Mitchener 1972). This effect was noted in 30% of control mice and 58% ($p < 0.001$) of selenium-treated mice. Data for individual organs were not provided.

Although myocardial degeneration and necrosis have been experimentally induced in laboratory animals and livestock including cattle, sheep, and swine by acute and longer-term exposures to inorganic salts of selenium, it is unclear whether seleniferous grains or forages, or other natural sources of selenium, can also cause cardiomyopathy (Raisbeck 2000).

Gastrointestinal Effects. In humans, gastrointestinal distress, including nausea, vomiting, diarrhea, and abdominal pain, has been reported following ingestion of aqueous sodium selenate (Civil and McDonald 1978; Gasmi et al. 1997; Helzlsouer et al. 1985; Koppel et al. 1986; Sioris et al. 1980). Two studies provided an estimate of dose. In a case report by Civil and McDonald (1978), diarrhea was observed in a 15-year-old girl about 45 minutes after she swallowed sheep drench containing selenate at a dose of about 22 mg selenium/kg. This effect was observed despite the induction of vomiting shortly after the exposure. In a second case report of a suicide attempt, a 56-year-old man reported that vomiting, diarrhea, and abdominal pain occurred 1 hour after he ingested approximately 11 mg/kg selenium as sodium selenite (Gasmi et al. 1997). Postmortem examinations following two deaths from selenium ingestion revealed dilation of the stomach and small intestine (Carter 1966) and erosive changes of the gastrointestinal tract (Koppel et al. 1986). High (unspecified) levels of dietary selenium compounds have been implicated as causing gastrointestinal disturbances in chronically exposed humans (Smith et al. 1936), but such symptoms are not specific to selenium intoxication.

Exposure of pigs to feed containing 54 mg/kg selenium for 1–7 days resulted in severe toxicity and death of several animals. Clinical signs included anorexia and vomiting, and histological examination (70–79 days after exposure) of three of the exposed animals that died found lesions ranging from small erosions (1–2 mm diameter) to extensive mucosal necrosis (up to 100 mm diameter) near the cardia of the stomach (Penrith and Robinson 1996).

Gross necropsy of steers that died after ingestion of sodium selenite revealed severe gastrointestinal irritation (Baker et al. 1989; Maag et al. 1960). In addition, cattle and other livestock exhibiting alkali

3. HEALTH EFFECTS

disease, perhaps as a result of long-term consumption of range plants high in selenium, ate and drank less and suffered from ulcers in the upper intestinal tract (Shamberger 1986). A single oral dose of 5 mg selenium/kg as selenite caused edema and congestion of abdominal viscera in lambs (Smyth et al. 1990). However, treatment of steers with selenomethionine or selenite in food at doses up to 0.808 mg selenium/kg/day for 120 days did not produce any changes in histology of the gastrointestinal tissues (O'Toole and Raisbeck 1995).

Gastrointestinal effects were not observed in rats treated with selenite in the diet for 8 weeks at a dose of 0.45 mg selenium/kg/day (Chen et al. 1993). Selenium treatment in drinking water for 13 weeks at doses up to 1.57 and 7.17 mg selenium/kg/day as selenate in rats and mice, respectively, and 1.67 and 3.83 mg selenium/kg/day as selenite in rats and mice, respectively, did not cause any gastrointestinal effects (NTP 1994). Gastrointestinal effects were not observed in rats fed organic selenium (seleniferous corn or wheat) at 0.5 mg selenium/kg/day for 24 months (Nelson et al. 1943). Vomiting and anorexia were reported in monkeys receiving 0.15 mg/kg/day selenium as L-selenomethionine by oral intubation during gestation days 20–50 (Tarantal et al. 1991).

Selenium sulfide administration by gavage at lethal levels has been reported to cause diarrhea and anorexia in rats (Cummins and Kimura 1971). No gastrointestinal effects were seen in mice administered 464 mg selenium sulfide/kg/day or in rats administered 31.6 mg selenium sulfide/kg/day by gavage once daily for 13 weeks (NTP 1980c).

Hematological Effects. Hematological changes were evaluated in a 120-day double blind study of healthy men who consumed a controlled diet of foods naturally low or high in selenium (Hawkes et al. 2001). Eleven subjects were fed 0.0006 mg selenium/kg/day in the diet for 21 days (baseline period), followed by 0.0002 mg/kg/day (6 subjects) or 0.004 mg/kg/day (5 subjects) for the following 99 days. Complete blood counts (white blood cells, lymphocytes, granulocytes, platelets, erythrocytes, hematocrit) and hemoglobin concentration measurements showed no adverse effects of selenium supplementation. Mean within-subject changes from baseline in white blood cell counts were significantly different in the low- and high-selenium groups at last two time points in the study (days 70 and 99). At the end of the study, the white blood cell counts were decreased by 5% in the high-selenium group and increased by 10% in the low-selenium group, due mainly to changes in numbers of granulocytes. Lymphocyte counts were significantly increased in the high-selenium group on day 45, but not at the end of the study. There were no clear effects of selenium on numbers of activated or cytotoxic T-cells, lymphocyte phenotypes,

3. HEALTH EFFECTS

serum immunoglobulins, or complement fractions, as summarized in Section 3.2.2.3 (Immunological Effects).

Increased prothrombin time was reported for individuals chronically exposed to estimated dietary doses of 0.016 mg selenium/kg/day in a high-selenium region of China (Yang et al. 1989a). However, no increase in prothrombin time was found in another study of individuals consuming diets that supplied up to 0.0098 mg/kg/day selenium (Longnecker et al. 1991). A study that compared children from seleniferous and nonseleniferous areas of Venezuela found slightly reduced (no statistical analysis was performed) hemoglobin levels and hematocrit values for the children from the seleniferous area (Jaffe et al. 1972). However, the children from the seleniferous zone had a poorer diet, consumed less milk and meat, and had a greater incidence of intestinal parasites, which may account for the differences observed. Red blood cell counts were significantly increased in mice that received drinking water containing 9 ppm (0.82 mg selenium/kg/day) selenium as sodium selenite for 14 days (Johnson et al. 2000). However, these mice also had a severe reduction in water consumption (43%) and this may have led to a decrease in blood volume. No significant increase in red blood cell count (or decrease in water consumption) was observed for mice receiving 3 ppm (0.38 mg selenium/kg/day) selenium as sodium selenite, or up to 9 ppm (1.36 mg selenium/kg/day) selenium as selenomethionine for 14 days (Johnson et al. 2000).

No hematological changes (hemoglobin concentration, hematocrit, erythrocyte count, and cell volume) were reported for male Sprague-Dawley rats fed diets providing up to 0.27 mg selenium/kg/day as sodium selenite for 40 days (Eder et al. 1995). Increased hematocrit was observed in rats treated with selenate (1.56 mg selenium/kg/day) or selenite (1.67 mg selenium/kg/day) in the drinking water for 13 weeks, but only at concentrations that decreased water intake (NTP 1994). No effects on hematology end points were observed in mice treated with selenate or selenite in drinking water for 13 weeks at 7.17 mg selenium/kg for selenate and 3.83 mg selenium/kg/day for selenite (NTP 1994).

No differences in blood cell counts or hematological parameters were found in rabbits administered 0.137 mg selenium/kg/day as sodium selenite in the diet for 3 months, compared with control animals receiving a normal laboratory diet (Turan et al. 1999b).

A dose-related decrease in hematocrit was observed in rats fed seleniferous wheat (Halverson et al. 1966). Compared to controls, hemoglobin was decreased 23 and 79% at 0.32 and 0.56 mg selenium/kg/day, respectively. Hemoglobin reductions were most evident in the animals that had died during the experiments. In a 2-year cancer study, Harr et al. (1967) reported that the hemoglobin concentration

3. HEALTH EFFECTS

decreased by 0.5 g/100 mL with each 2-fold increase of sodium selenate in the diet, but did not specify the lowest dose at which hemoglobin concentrations were significantly reduced compared to the controls (the range of selenium doses used was 0.025–0.40 mg selenium/kg/day). Hematocrit was increased in rats given selenite and selenate in drinking water for 13 weeks at concentrations that also resulted in decreased water intake (NTP 1994). No hematological effects were noted in rats or mice treated with selenate at 0.92 and 7.17 mg selenium/kg/day, respectively, or selenite at 0.86 and 3.83 mg selenium/kg/day, respectively (NTP 1994).

No studies were located regarding hematological effects in humans or other animals after oral exposure to selenium sulfide or selenium disulfide.

Musculoskeletal Effects. No adverse musculoskeletal effects were reported following chronic oral exposure of humans to dietary levels of selenium of up to 0.0098 mg selenium/kg/day (Longnecker et al. 1991).

A single oral (subroute not specified) dose of sodium selenite (5 mg selenium/kg/day) caused edema in skeletal muscles of the diaphragm in sheep (Smyth et al. 1990). Exposure of pigs to feed containing 54 mg/kg selenium for 1–7 days resulted in severe toxicity and death of several animals (Penrith and Robinson 1996). Histological examination of skeletal muscle from animals that died found damage with interstitial oedema and diffuse swelling of fibers. Livestock suffering from chronic alkali disease, a disease once common in the southwestern United States where selenium levels are high, showed lameness due to joint erosion and hoof deformation (Shamberger 1986). However, treatment of steers with selenomethionine or selenite in food at doses up to 0.808 mg selenium/kg/day for 120 days did not produce any changes in muscle or bone histology (O'Toole and Raisbeck 1995). Hyperplasia of the sarcolemma nuclei and disintegration of myofibrils were observed in the skeletal muscles of pigs fed an unspecified form of selenium for 34 days (Stowe et al. 1992). In a 2-year cancer study, Harr et al. (1967) fed graded doses of selenium in the form of sodium selenate or selenite to rats and reported frank osteotoxicity at doses as low as 0.2 mg selenium/kg/day given for several months (duration specified as less than 100 days). Selenium administered in drinking water for 13 weeks at doses up to 1.57 and 7.17 mg selenium/kg/day as selenate in rats and mice, respectively, and 1.67 and 3.83 mg selenium/kg as selenite in rats and mice, respectively, failed to cause adverse musculoskeletal effects (NTP 1994). Musculoskeletal effects were not observed in rats fed seleniferous corn or wheat at 0.5 mg selenium/kg/day for 24 months (Nelson et al. 1943). No musculoskeletal effects were seen in mice

3. HEALTH EFFECTS

administered 464 mg selenium sulfide/kg/day or in rats administered 31.6 mg selenium sulfide/kg/day by gavage once daily for 13 weeks (NTP 1980c).

Hepatic Effects. Limited data suggest that hepatotoxicity can occur in humans following acute oral exposure to sodium selenate, but no definitive studies were located regarding hepatic effects in humans after intermediate or chronic oral exposure to selenium compounds. Tests following an acute poisoning of a 15-year-old girl with sodium selenate revealed abnormally elevated serum bilirubin and alkaline phosphatase (Civil and McDonald 1978). Hepatic effects, such as changes in serum liver enzymes or liver morphology (identified by ultrasonography), have not been observed in humans at chronic dietary intakes of 0.0098 mg selenium/kg/day (Longnecker et al. 1991) or 0.025 mg selenium/kg/day (Yang et al. 1989a). Selenium-induced hepatotoxicity is documented in animals as summarized below. The lack of evidence of liver damage in humans due to selenosis, despite the animal data to the contrary, suggests a problem with the animal models of the disease.

Congestion and/or edema and hemorrhage in the liver have been reported in sheep following the acute oral (subroute not specified) administration of lethal levels of sodium selenate (Hopper et al. 1985) or sodium selenite (Smyth et al. 1990) and in mules and pigs following administration of lethal levels of sodium selenite (Miller and Williams 1940). A significant decrease in relative liver weight was reported for mice exposed to 9 ppm (0.82 mg selenium/kg/day) selenium as sodium selenite in drinking water for 14 days, but not to 3 ppm (0.38 mg selenium/kg/day) (Johnson et al. 2000). No effect on liver weight was observed for mice receiving up to 9 ppm (1.36 mg selenium/kg/day) selenium as selenomethionine in drinking water for 14 days (Johnson et al. 2000).

Administration of single gavage doses of selenium monosulfide to rats produced death and widespread hepatic necrosis in 3/6 animals dosed with 75 mg/kg, 1/2 animals dosed with 100 mg/kg, and 2/2 animals dosed with 125 mg/kg (Moore et al. 1996b).

Hepatic effects have also been reported following intermediate-duration exposure in pigs, but not in cattle. Pigs exposed for 7 weeks to either dietary organic selenium in dried plants (either *A. pruelongus* or *A. bisulcatus*) or sodium selenate (at 1.1 or 1.3 mg selenium/kg/day) exhibited diffuse swelling and vacuolar degeneration of hepatocytes (Baker et al. 1989). The doses used in this study reduced mean survival to only 44 days. Pigs exposed to sodium selenite in feed for 35 days at doses less than half as high as those tested by Baker et al. (1989) (0.47 versus 1.1 or 1.3 mg selenium/kg/day) exhibited no liver damage (Mahan and Magee 1991). A study of pigs treated with 0.08, 0.33, 0.59, or 1.07 mg

3. HEALTH EFFECTS

selenium/kg/day as sodium selenite in the feed for 8 weeks found hepatic nodules/granules in two pigs treated with 0.59 or 1.07 mg selenium/kg/day (Mihailovic et al. (1992). The lesions were diagnosed as postdystrophic atrophic cirrhosis. However, only these two severely affected pigs (one from each of the highest dose groups of 40 animals each) were selected for histopathological examination. Hepatic effects were not observed in pigs fed selenium at 1.25 mg selenium/kg as organic selenium of the type(s) found in the plant *A. bisulcatus* for up to 5 days, or D,L-selenomethionine or selenate for up to 6 weeks (Panter et al. 1996). Treatment of steers with selenomethionine or selenite in food at doses up to 0.808 mg selenium/kg/day for 120 days did not produce any changes in liver weight or histology (O'Toole and Raisbeck 1995).

Alterations or cirrhosis of the liver in experimental animals following intermediate or chronic oral exposure to selenium compounds have been reported by Bioulac-Sage et al. (1992), Fitzhugh et al. (1944), Halverson et al. (1970), Harr et al. (1967), Kolodziejczyk et al. (2000), Nelson et al. (1943), and Schroeder and Mitchener (1972). Halverson et al. (1966) reported reduced liver-to-body-weight ratios and increased bilirubin in rats administered 0.44 mg selenium/kg/day for 6 weeks as naturally occurring selenium in wheat. At this level, five of eight rats died. At a dose of 0.84 mg selenium/kg/day administered as sodium selenate in drinking water for 4–6 weeks, rats developed cirrhosis of the liver (Palmer and Olson 1974). At this level, two of six rats died.

Hepatic damage was observed in mice exposed to 0.2 mg selenium/kg/day as sodium selenite in food for 12 weeks (Skowerski et al. 1997a), and ultrastructural examination showed that the cytoplasm of the hepatocytes contained extremely large and irregularly-shaped vacuoles. Wistar rats administered 0.324 mg selenium/kg/day as sodium selenite in food for 12–14 weeks showed degenerative changes to the liver (not fully described in text) (Turan et al. 1999a). Livers of rats fed 0.002 or 0.005 mg selenium/kg/day as sodium selenite for 3 months showed damage that increased with dose (Kolodziejczyk et al. 2000). Rats from the 0.002 mg selenium/kg/day group had a distinct swelling of K upffer cells in dilated sinusoidal vessels, mainly in the proximity of portal fields, and occasional necrotic areas comprising groups of hepatocytes, while livers from rats receiving 0.005 mg selenium/kg/day showed activation and swelling of the K upffer cells in widened sinusoidal vessels, relatively abundant infiltrations of mononuclear cells into portal canals, and sporadic areas of necrosis within individual lobules.

Young rats treated with sodium selenite in the feed for 2 months had nodular hyperplasia at a dose of 0.2 mg selenium/kg/day. However, clinical tests of liver function (bilirubin, alanine aminotransferase, aspartate aminotransferase, alkaline phosphatase, and gamma-glutamyltransferase activities) showed no

3. HEALTH EFFECTS

significant changes (Bioulac-Sage et al. 1992). Diffuse panlobular vacuolar changes were reported in rats fed sodium selenite in the diet for 8 weeks at 0.45 mg/kg/day (Chen et al. 1993).

In a 2-year cancer study, acute toxic hepatitis was common among rats fed sodium selenite or sodium selenate at 0.25 mg selenium/kg/day or higher (Harr et al. 1967; Tinsley et al. 1967). Liver surfaces were mottled, and parenchymatous degeneration was present. Hepatic lesions occurred at a dose as low as 0.10 mg selenium/kg/day. Absolute liver weights decreased with increasing levels of sodium selenate or sodium selenite in the diet. The average liver weight of animals administered selenate (14.5 g) was twice the average liver weight of animals administered selenite (7.2 g); however, the average liver weight of control animals was not reported, and possible dose-related hepatic effects were not discussed by these authors.

Increased serum bile acids, suggesting cholestasis, were observed in rats treated with 1.57 mg selenium/kg/day as sodium selenate in drinking water for 13 weeks, but no effects were noted at 0.92 mg/kg/day (NTP 1994). In a 13-week drinking water study, hepatic effects were not observed in mice treated with sodium selenate at 7.17 mg selenium/kg/day, in mice treated with sodium selenite at doses up to 3.83 mg selenium/kg/day, or in rats treated with sodium selenite at doses up to 1.67 mg selenium/kg/day (NTP 1994). Increased serum aspartate aminotransferase and alanine aminotransferase activities were observed in mice treated by gavage with selenocystine at doses of 9.4 mg selenium/kg/day for 30 days (Sayato et al. 1993) or 4.7 mg selenium/kg/day for 90 days (Hasegawa et al. 1994). No effects on liver enzymes were observed in mice treated with selenocystine at 4.7 mg selenium/kg/day for 30 days (Sayato et al. 1993) or at 2.5 mg selenium/kg/day for 90 days (Hasegawa et al. 1994). Chronic dietary administration of selenium as seleniferous corn or wheat at doses ranging from 0.25 to 0.50 mg/kg/day for 24 months produced cirrhosis of the liver in rats (Nelson et al. 1943).

An increased incidence of amyloidosis of the major organs, including the liver, was observed in mice following lifetime exposure to sodium selenate or sodium selenite in drinking water at a level of 0.57 mg selenium/kg/day (Schroeder and Mitchener 1972). This effect was noted in 30% of control mice and 58% ($p < 0.001$) of selenium-treated mice. Data for individual organs were not provided.

Selenium sulfide administered to rats daily by gavage for 13 weeks produced focal coagulation necrosis in the liver with infiltration by inflammatory cells. These changes developed at a dose of 31.6 mg selenium sulfide/kg/day, but not at a dose of 17.8 mg selenium sulfide/kg/day (NTP 1980c). In mice, on

3. HEALTH EFFECTS

the other hand, oral intubation of selenium sulfide at 464 mg selenium sulfide/kg/day did not produce hepatic effects (NTP 1980c).

Renal Effects. No studies were located regarding renal effects in humans after oral exposure to selenium or selenium compounds.

In domestic and experimental animals, renal effects have been observed following both acute and chronic oral exposures to selenium compounds. Administration of a single oral (subroute not specified) dose of sodium selenite at 5 mg selenium/kg/day produced hydropic degeneration of the kidney in sheep (Smyth et al. 1990). In a study of the toxicity of L-selenomethionine to long-tailed macaques by nasogastric intubation, two animals administered 0.24 mg selenium/kg/day aspirated vomitus secondary to emesis, developed obvious gastritis, and died of anorexia, one after 10 days and the other after 15 days of administration (Cukierski et al. 1989). Histopathologic examination of the kidneys of these animals revealed glomerulonephritis and proximal convoluted tubule nephropathy. The study authors indicated that these changes were consistent with macaque fatal fasting syndrome and may not have resulted from the direct effects of L-selenomethionine. Following long-term ingestion of plants high in selenium, livestock suffering from alkali disease exhibited nephritis (Shamberger 1986). However, treatment of steers with selenomethionine or selenite in food at doses up to 0.808 mg selenium/kg/day for 120 days did not produce any changes in kidney weight or histology (O'Toole and Raisbeck 1995).

A dose-related increase in degeneration of the renal papilla (described as mild to minimal) was observed in rats treated with selenate or selenite in the drinking water at about 0.5 mg selenium/kg/day for 13 weeks (NTP 1994). No evidence of renal toxicity was observed in rats given 0.3 mg selenium/kg/day in this study. In contrast to rats, the only kidney effect noted in mice treated with sodium selenate or selenite in the drinking water was increased relative kidney weight (NTP 1994). This effect, which occurred at 1.87 mg selenium/kg/day as selenate and 1.61 mg selenium/kg/day as selenite, was only noted at doses at which drinking water intake was decreased, leading the investigators to suggest that the effect may have been a result of dehydration. A similar increase in relative kidney weight associated with decreased water consumption was observed in mice consuming approximately 0.38 mg selenium/kg/day as selenite in drinking water, but no effect on kidney weight or water consumption was observed in mice consuming up to 1.36 mg selenium/kg/day as selenomethionine (Johnson et al. 2000). No renal effects were observed in pigs fed selenium at 1.25 mg selenium/kg as organic selenium found in the plant *A. bisulcatus* for up to 5 days, or D,L-selenomethionine or selenate for up to 6 weeks (Panter et al. 1996). No effects on the kidneys were observed in rats treated with selenite in the diet for 8 weeks at a dose of

3. HEALTH EFFECTS

0.45 mg selenium/kg/day (Chen et al. 1993). Gavage treatment of mice with selenocystine for 30 days at a dose of 9.4 mg selenium/kg/day had no adverse effect on the kidneys (Sayato et al. 1993).

Rats chronically fed selenite in the diet were reported to exhibit more frequent and more severe nephritis than those given equivalent amounts of selenate (Harr et al. 1967); however, the study authors did not quantify these observations or statistically compare data from the two groups. An increased incidence of amyloidosis of the major organs, including the kidneys, was observed in mice following lifetime exposure to sodium selenate or sodium selenite in drinking water at a level of 0.57 mg selenium/kg/day (Schroeder and Mitchener 1972). This effect was noted in 30% of control mice and 58% ($p < 0.001$) of selenium-treated mice. Data for individual organs were not provided.

A mixture of selenium sulfide and selenium disulfide administered to mice daily by gavage for 13 weeks at a dose of 464 mg selenium sulfides/kg/day produced an increase in the incidence and severity of interstitial nephritis compared with the controls, whereas a daily dose of 216 mg selenium sulfides/kg did not elicit renal toxicity (NTP 1980c). In rats, selenium sulfide by oral intubation at 31.6 mg selenium sulfides/kg/day for 13 weeks did not produce renal effects (NTP 1980c).

Endocrine Effects. A balance in selenium and iodine levels is needed for normal thyroid hormone metabolism. Selenium is an essential component of the iodothyronine 5'-deiodinase enzymes, which convert the prohormone thyroxine (T_4) to the active form, triiodothyronine (T_3) (Delange 2000; Köhrle 1994; St Germain and Galton 1997). Selenium is also a component of glutathione peroxidase (GPX), the main enzyme responsible for protecting thyroid cells against oxidative damage. Selenium deficiency causes decreases in metabolic clearance of iodothyronines, extrathyroidal production of T_3 , and thyroid iodine concentrations in experimental animals (Arthur and Beckett 1989, 1994; Behne and Kyriakopolous 1993). Deficiency in both selenium and iodine has been associated with goiter and cretinism in humans and causes thyroid gland necrosis and fibrosis in rats (Delange 2000; Goyens et al. 1987; Vanderpas et al. 1990). Additional information on thyroid effects of selenium and iodine deficiency is discussed in Section 3.9. Thyroid hormone levels in humans and animals can also be affected by selenium supplementation; these effects include decreases in serum T_3 and T_4 levels and increases in serum TSH levels, suggesting suppression of thyroid hormone production, as discussed below.

A limited amount of information is available regarding endocrine effects in humans following oral exposure to selenium. Serum levels of thyroid and reproductive hormones were evaluated in a double blind 120-day study of healthy men (20–45 years old) who consumed a controlled diet of foods naturally

3. HEALTH EFFECTS

high or low in selenium (Hawkes and Turek 2001). Eleven subjects were fed 0.0006 mg/kg/day of selenium in the diet for the first 21 days of the study, followed by 0.0002 µg selenium/kg/day (6 subjects) or 0.004 mg selenium/kg/day (5 subjects) for 99 days. Blood samples were analyzed for serum levels of selenium, thyroid hormones (T₃ and TSH), and reproductive hormones (testosterone, follicle-stimulating hormone, luteinizing hormone, prolactin, estradiol, and progesterone) during week 3 (baseline), week 17 (ending value), and at several interim time points.

Selenium levels in blood plasma began to change within 3 days of starting the low- and high-selenium diets and progressively continued throughout the study (Hawkes and Turek 2001). By week 17, mean plasma selenium concentrations had increased by 109% in the high-selenium group and decreased by 38.5% in the low-selenium group. Group mean serum T₃ concentrations (averages of within-subject changes from baseline) were significantly different in the low-selenium subjects and high-selenium subjects at all time points, but the changes are insufficient to be considered adverse as discussed below. In the low-selenium group, serum T₃ levels increased an average of 14 and 8% from baseline at weeks 8 and 17, respectively. In the high-selenium group, serum T₃ levels decreased an average of 23 and 11% from baseline at weeks 8 and 17, respectively. Analysis of variance (ANOVA) showed a significant main effect of dietary selenium on serum T₃ concentrations, as well as a significant selenium x time interaction, indicating that the changes in T₃ levels decreased over time. Although the decreases in serum T₃ in the high-selenium group and increases in serum T₃ in the low-selenium group lessened in magnitude during the study, all group mean values appear to have remained within the normal range. The baseline and week 17 serum total T₃ values (mean±SD) were 1.82±0.36 and 1.57±0.07 nmol/L in the high-selenium group, and 1.57±0.25 and 1.64±0.16 nmol/L in the low-selenium group, compared to the normal human range of 1.1–2.7 nM/L (Stockigt 2000), indicating that the changes in serum T₃ were subclinical and not toxicologically significant. Serum TSH concentrations increased significantly by 32% over its baseline concentration in the high-selenium group, but did not change significantly in the low-selenium group. Baseline and ending mean TSH values in the high-selenium group were 2.25±0.81 and 2.96±1.05 mU/L, respectively, both of which are in the normal range of 0.3–4.0 mU/L (Stockigt 2000). The lack of clinically significant changes in serum T₃ and TSH values is not surprising because the study was designed as a nutritional study and not as a toxicological study; the selenium intakes bracketed the current recommended dietary allowance (RDA) (~0.8 µg Se/kg/day) and were well below the tolerable upper limit level (~5.7 µg Se/kg/day) recommended by the Food and Nutrition Board (NAS 2000). There were no significant changes in serum levels of free or total testosterone, follicle-stimulating hormone, luteinizing hormone, prolactin, estradiol, or progesterone. This study also found no adverse immunologic or male reproductive changes as summarized in Sections 3.2.2.3 and 3.2.2.5.

3. HEALTH EFFECTS

An examination of thyroid hormone levels in lactating women residing in areas of Venezuela with high levels of selenium in the soil (selenium intake ranged from 250 to 980 µg per day as estimated from selenium content of breast milk) revealed a significant decrease in serum T₃ levels, as compared with women having normal selenium intakes (90–350 µg/day), but these hormone levels remained within the normal range (Brätter and Negretti De Brätter 1996). Additionally, a significant inverse correlation for selenium and serum T₃ concentration was found using the Spearman Rank test. The study authors noted that the effect of selenium on T₃ levels became significant at dietary intake levels of 350–450 µg/day. No significant alterations in serum T₄ or TSH levels or correlations with selenium intake were found.

Twenty weeks of selenium supplementation (10, 20, 30, or 40 µg/day) of New Zealanders who normally consume a diet low in selenium (unsupplemented intake of 28–29 µg/day), but show no signs of deficiency, produced a reduction in T₄ concentration in all groups (Duffield et al. 1999). However, only the differences between the 10 µg-group and controls and the combined supplemented individuals and controls were significant. T₃ and TSH levels were not measured. Thyroglobulin concentration did not change significantly with supplementation.

In a study of 68 male Latvian fish consumers (Hagmar et al. 1998), a significant inverse correlation was found between serum levels of selenium and TSH. No correlation was found between serum selenium concentration and the serum concentrations of T₃ or T₄. No measurements were made of dietary selenium intake.

Selenium supplementation has been shown to affect type-I-deiodinase activity in male rats (Behne et al. 1992; Eder et al. 1995; Hotz et al. 1997). Exposure to 0.055 or 0.27 mg selenium/kg/day as sodium selenite in food for 40 days produced a significant decrease (approximately 50%) in serum levels of T₃ and a nonsignificant reduction in type-I-deiodinase activity compared with rats receiving 0.009 or 0.026 mg selenium/kg/day (Eder et al. 1995). Exposure to 0.27 mg selenium/kg/day did not produce any other adverse signs, such as weight loss or decreased food consumption, and serum T₄ levels were similar in all groups.

Exposure of weanling male Sprague-Dawley rats to 0.09 mg selenium/kg/day as sodium selenate in food for 6 weeks produced a significant (~30%) increase in TSH, compared with controls receiving 0.009 mg selenium/kg/day (Hotz et al. 1997). Serum T₃ and T₄ levels and thyroid glutathione peroxidase levels were unaffected by dietary selenium. Kidney type-I-deiodinase levels were decreased (~10%) in high

3. HEALTH EFFECTS

selenium animals compared with controls, but the differences were not significant, and liver type-I-deiodinase levels were unaffected by dietary selenium. Iodine-deficient diets produced greater thyroid glutathione peroxidase activity at each dietary level of selenium, and the greatest activity was in rats with high selenium.

No significant changes in thyroid levels of T₃ or T₄ were found in male Wistar rats fed diets containing high selenium (0.105 mg selenium/kg/day as sodium selenite or 0.118 mg selenium/kg/day as L-selenomethionine) for 3 months, compared with controls receiving adequate selenium (0.0015 mg selenium/kg/day as sodium selenite) (Behne et al. 1992). However, rats eating the high selenium diet showed a significant reduction in hepatic type I deiodinase activity, compared with controls, with a 29% reduction in the production rate of T₃ from T₄ and a 45% reduction in the production rate of 3,3'-diiodothyronine from T₄.

Many studies have documented reduced body weight gain in young animals treated with selenium compounds, and abnormal weight loss in older animals (Grønbaek et al. 1995; Halverson et al. 1966; Harr et al. 1967; Jacobs and Forst 1981a; Johnson et al. 2000; Nelson et al. 1943; NTP 1994; Palmer and Olson 1974; Panter et al. 1996; Schroeder 1967; Tarantal et al. 1991; Tsunoda et al. 2000). There is evidence to suggest that these effects may be due in part to the interactions of selenium or selenium compounds with hormones that regulate normal growth and body weight. In a 14-day study suggesting that selenium may inhibit pituitary function, Thorlacius-Ussing (1990) treated nursing rats with sodium selenite in drinking water (0.64 or 0.96 mg/kg/day). The resulting decrease in the body weight gain of the pups observed at both doses may be associated with a reduction in somatomedin C levels (no other hormone levels were tested), and the weight deficiency could be reversed by administration of a growth hormone. Postweanling female Wistar rats treated with sodium selenite (0.64 mg selenium/kg/day) in drinking water for 3 or 6 weeks exhibited decreased weight gain and decreased somatomedin C serum concentrations. When the selenium supplement was removed after 3 weeks, body weight gain returned to normal, but the serum somatomedin C concentrations did not return to control levels. Growth hormone secretion in response to growth hormone releasing factor was also reduced in the selenium-exposed group (Thorlacius-Ussing et al. 1988). Serum somatomedin C levels were not significantly different among three exposure categories (<200, 201–240, and >240 ng selenium/mL) in 44 long-term residents of seleniferous areas in South Dakota, despite >50% differences in serum, whole blood, and toenail selenium levels among the groups (Salbe et al. 1993). A 10% reduction in body weight and a reduction in tibia lengths, compared to pair-fed controls, were found in rats provided with sodium selenite in the drinking water at 0.46 mg selenium/kg/day for 35 days (Grønbaek et al. 1995). A significant reduction in insulin-

3. HEALTH EFFECTS

like growth factor-binding protein-3 was also noted. The investigators concluded that the reduction in growth caused by excess selenium is not due to reduced caloric intake.

Selenium administered in drinking water for 13 weeks at doses up to 1.57 and 7.17 mg selenium/kg/day as selenate in rats and mice, respectively, and 1.67 and 3.83 mg selenium/kg as selenite in rats and mice, respectively, failed to cause changes in the weights or histology of the thyroid, adrenal glands, parathyroid, or pancreas (NTP 1994).

Lambs given a single oral (subroute not specified) dose of 5 mg selenium/kg as sodium selenite exhibited cytoplasmic flocculation of the pancreas (Smyth et al. 1990). Increased pancreas weights were observed in rats fed organic selenium (seleniferous wheat) at a dose of 0.4 mg selenium/kg/day for 6 weeks (Halverson et al. 1966). Chronic exposure of rats fed sodium selenite or sodium selenate in their diet for a lifetime was associated with pancreatic damage. Although Harr et al. (1967) reported a dose-related increase in the incidence and severity of pancreatic lesions in treated rats, they did not specify the lowest dose at which pancreatic lesions were observed.

Treatment of steers with selenomethionine or selenite in food at doses up to 0.808 mg selenium/kg/day for 120 days did not produce any changes in weight or histology of the pancreas, adrenal glands, thyroid, or pituitary gland (O'Toole and Raisbeck 1995).

An increased incidence of amyloidosis of the major organs, including the adrenal gland, was observed in mice following lifetime exposure to sodium selenate or sodium selenite in drinking water at a level of 0.57 mg selenium/kg/day (Schroeder and Mitchener 1972). This effect was noted in 30% of control mice and 58% ($p < 0.001$) of selenium-treated mice. Data for individual organs were not provided.

Dermal Effects. Jensen et al. (1984) described both marked alopecia and the deformity and loss of fingernails in a woman who had consumed a selenium supplement containing 31 mg total selenium (in the form of sodium selenite and elemental selenium) per tablet for 77 days. The woman consumed one tablet each day in addition to vitamin supplements (vitamins C, A, D, E, B complex) and a mineral supplement "labeled as containing all 72 trace elements in undefined quantities." In epidemiological studies of populations chronically exposed to high levels of selenium in food and water, investigators have reported discoloration of skin, pathological deformity and loss of nails, loss of hair, and excessive tooth decay and discoloration (Smith et al. 1936; Yang et al. 1983, 1989a, 1989b). The 1989 studies by Yang et al. follow up their original 1983 study of Chinese populations living in areas classified as having

3. HEALTH EFFECTS

low-, medium-, and high-selenium exposure based on local soils and food supplies. The average and standard error of selenium intakes in the low-, medium-, and high-intake regions were 0.0012 ± 0.00009 , 0.0037 ± 0.0004 , and 0.025 ± 0.001 mg/kg/day, respectively. The whole blood (average \pm standard error) concentrations of selenium in the low-, medium-, and high-intake regions were 0.16 ± 0.00 , 0.35 ± 0.02 , and 1.51 ± 0.05 mg/L, respectively. The estimated daily dietary selenium intake required to produce these symptoms in an area of China characterized by endemic selenosis was at least 0.016 mg selenium/kg/day (Yang et al. 1989a). This corresponds to a blood concentration of 1.054 mg/L and an estimated daily intake of 0.91 mg/day, assuming a 55-kg Chinese man or woman and using the regression analysis provided by Yang et al. (1989b). The NOAEL from the highest intake population not affected by nail disease is 0.015 mg selenium/kg/day, which corresponds to a blood concentration of 0.97 mg/L. Foods that contributed the greatest levels of selenium were smoked pork, coal-dried corn, chestnuts, pumpkin seeds, dried fruits, and garlic. It has been noted that the selenosis problem in China began when coal with high levels of selenium was burned as the main source of fuel (Whanger 1989). Food was cooked and dried over the open flame, adding selenium to the food. In addition, the people breathed large amounts of smoke, but the contribution of volatilized selenium to the total dose of selenium has not been adequately characterized (Whanger 1989). Coal was also burned on the fields as a fertilizer source. Environmental selenium concentrations in the low-, medium-, and high-intake regions were 0.37–0.48, 0.73–5.66, and 7.06–12.08 mg/kg in soil, and 370, 1,720, and 12,270 μ g/L in water, respectively (Yang et al. 1989b).

No evidence of nail disease was observed in a population living on selenium-rich ranches in the western United States (Longnecker et al. 1991). Doses of selenium were calculated to be between 0.001 and 0.01 mg/kg/day, corresponding to a maximum intake of 0.724 mg/day. Whole blood selenium concentrations were 0.18–0.67 mg/kg. Although these values for the United States are consistent with studies of the Chinese population, only one or a few individuals ingested the highest doses.

The highest selenium intake for villagers in a high-selenium area of China in which endemic selenosis did not occur was estimated at 1.51 mg selenium/person/day (0.027 mg selenium/kg/day), with the average dietary selenium intake in this area of selenosis occurrence estimated to be 3.2 mg selenium/person/day (0.058 mg selenium/kg/day) (Yang et al. 1983). The lowest daily dietary selenium intake associated with dermal effects, 0.91 mg selenium/day, was converted to equivalent daily doses from food (0.016 mg/kg/day) for presentation in Table 3-2.

Five individuals from the high selenium region of China described by Yang et al. (1989a) who had been diagnosed with overt signs of selenosis (hair loss and nail sloughing) in 1986 were reexamined in 1992

3. HEALTH EFFECTS

(Yang and Zhou 1994). The results of this examination showed that these individuals had recovered from selenosis (overt symptoms of nail sloughing were absent) and that the average selenium concentrations in their blood had fallen from 1,346 to 968 µg/L. The corresponding dietary intakes of selenium were 1,270 and 819 µg/day. This study has been used to establish a LOAEL of 0.023 mg selenium/kg/day and a NOAEL of 0.015 mg selenium/kg/day. Based on the occurrence of these dermal effects, a chronic oral MRL of 0.005 mg selenium/kg/day has been derived from the NOAEL, as described in the footnote in Table 3-2 and detailed in Appendix A. This MRL is approximately 6 times greater than the NAS (2000) RDA for selenium of 55 µg/day (~0.0008 mg/kg/day).

In a 30-day study of oral administration of L-selenomethionine to long-tailed macaques, skin lesions appeared on the forearm of one of two macaques given 0.01 mg selenium/kg/day. However, the limited number of animals precludes identifying the dose as a LOAEL for dermal effects (Cukierski et al. 1989). Pigs receiving dietary administration of the same doses of selenium for 35 days exhibited hoof cracking (Mahan and Magee 1991). Symmetrical hair loss, dry scaling skin, and cracked overgrown hooves were observed in one of five pigs and three of five pigs fed sodium selenate or D,L-selenomethionine at a dose of 1.25 mg selenium/kg/day for up to 6 weeks, respectively (Panter et al. 1996). In an experiment limited to a duration of 5 days because of severe paralysis, similar dermal effects were not observed in pigs fed 1.25 mg selenium/kg/day as selenium contained in the plant *A. bisulcatus*. The form of selenium in *A. bisulcatus* is unknown, although Panter et al. (1996) indicate that it is nonprotein.

Exposure of pigs to feed containing 54 mg/kg selenium for 1–7 days resulted in severe toxicity and death of several animals; however, none of the pigs developed coronitis or hoof separation (Penrith and Robinson 1996). Skin from four pigs with alopecia was examined about a month after exposure and was found to have epidermal thickening due to acanthosis and hyperkeratosis, vacuolar degeneration of the basal cells and acanthocytes, necrosis of individual keratinocytes, and serocellular crusts.

In the late 19th and the early 20th century, livestock grazing on plants growing on seleniferous soils in areas of the Great Plains of the United States suffered from alkali disease attributed to the high selenium content of some plants. Alkali disease in horses, cattle, and swine is characterized by alopecia, inflammation at the coronary band, followed by cracked or malformed hooves and rough hair coat (Draize and Beath 1935). Daily selenium intakes associated with these effects were not quantified. However, treatment of steers with selenomethionine in food at doses of 0.288 mg selenium/kg body weight/day or selenite at doses of 0.808 mg selenium/kg/day for 120 days produced hoof lesions (O'Toole and Raisbeck 1995). In intermediate-duration studies, cracked hoof walls have been observed in pigs fed selenate,

3. HEALTH EFFECTS

selenite, or an unspecified form of selenium at doses of 0.25 mg selenium/kg/day and greater (Baker et al. 1989; Mahan and Magee 1991; Mihailovic et al. 1992; Wahlstrom and Olson 1959b). Poor quality of the hair coat has also been reported in mice administered sodium selenite or selenate in the diet at 0.57 mg selenium/kg/day (Schroeder and Mitchener 1972). Exposure of female BALB/c mice to 0.21 mg selenium/kg/day for 6 months from diets containing selenium as sodium selenite resulted in alopecia around the nose (Boylan et al. 1990).

No studies were located regarding dermal effects in humans or other animals after oral exposure to selenium sulfide or selenium disulfide.

Ocular Effects. A case-control study using a hospital discharge register indicated that there was no correlation between low serum selenium concentrations and cataract occurrence in humans (Knekt et al. 1992). Since this is a case-control study, it does not provide information on the potential dietary factors, exposure to specific selenium compounds, or duration of exposure.

Treatment of steers with selenomethionine or selenite in food at doses up to 0.808 mg selenium/kg/day for 120 days did not produce any changes in the histology of the eyes (O'Toole and Raisbeck 1995). Selenium given to rats and mice in drinking water for 13 weeks at up to 1.6 and 7.2 mg selenium/kg as selenate, respectively, or 1.7 and 3.8 mg selenium/kg as selenite, respectively, did not cause any ocular effects (NTP 1994).

Body Weight Effects. Two studies reported body weight effects in humans after oral exposure to selenium. Selenium intake was found to affect body weight in a study of 11 men (20–45 years old) who were fed 0.0006 mg/kg/day of selenium in the diet for the first 21 days of the study, followed by diets naturally low (0.0002 µg selenium/kg/day, 6 subjects) or high (0.004 mg selenium/kg/day, 5 subjects) for 99 days at 2,800 kcal/day (Hawkes and Keim 1995). Despite minor adjustments of intake to maintain body weight, by the 6th week, the high selenium group started to gain weight relative to the low selenium group, and the difference between the two groups became significant after the 10th week. A similar increase in lean body mass was observed in both groups. The study was designed as a nutritional study and not as a toxicological study, as the selenium intake levels were well below the tolerable upper limit level (~5.7 µg Se/kg/day) recommended by the Food and Nutrition Board (NAS 2000). The weight gain observed in this study therefore has nothing to do with weight loss due to selenosis.

3. HEALTH EFFECTS

A study that compared children from seleniferous and nonseleniferous areas of Venezuela found slightly reduced height and weight (no statistical analysis was performed) for the children from the seleniferous area (Jaffe et al. 1972). However, the children from the seleniferous zone had a poorer diet, consumed less milk and meat, and had a greater incidence of intestinal parasites, which may account for the differences observed.

In contrast, reduced growth rates of young animals and reduced body weight in older animals are common observations associated with oral administration of excess sodium selenate, sodium selenite, or organic selenium compounds to experimental animals (Boylan et al. 1990; Cukierski et al. 1989; Donaldson and McGowan 1989; Grønbaek et al. 1995; Halverson et al. 1966; Harr et al. 1967; Hasegawa et al. 1994; Johnson et al. 2000; Nelson et al. 1943; NTP 1994, 1996; Palmer and Olson 1974; Panter et al. 1996; Penrith and Robinson 1996; Raisbeck et al. 1996; Sayato et al. 1993; Schroeder 1967; Tarantal et al. 1991; Thorlacius-Ussing 1990, Tsunoda et al. 2000; Turan et al. 1999a). This reduction in growth is often accompanied by reduced food and water consumption, and in dietary or drinking water studies, may be an effect of poor palatability of selenium compounds. However, reduced growth has also been observed in gavage studies (Cukierski et al. 1989; Hasegawa et al. 1994; Sayato et al. 1993) and, as discussed under endocrine and neurological effects, the growth retardation may have an endocrine or neurotransmitter component. Selenium effects on the levels of thyroid hormones (Behne and Kyriakopoulos 1993; Behne et al. 1992; Eder et al. 1995; Hotz et al. 1997), dopamine metabolites (Tsunoda et al. 2000), insulin-like growth factor-binding protein-3 (Grønbaek et al. 1995), and somatomedin C (Thorlacius-Ussing 1990) have been observed in selenium-treated animals, although somatomedin C was not a sensitive end point in humans from a high selenium area of South Dakota (Salbe et al. 1993).

Other Systemic Effects. Urinary excretion of selenium was about twice as great in children with a high incidence of dental caries than in children with a low incidence of caries (Hadjimarkos 1969b). Possible confounding factors (e.g., fluoride status and socioeconomic status) were not considered, however. In Yang et al. (1989a), the incidence of mottled teeth in the medium- and high-selenium groups was increased, but the effect was attributed to interactions between selenium and fluoride.

3. HEALTH EFFECTS

3.2.2.3 Immunological and Lymphoreticular Effects

No studies were located regarding adverse immunologic or lymphoreticular effects in humans after oral exposure to selenium or selenium compounds. Immune system effects were evaluated in a 120-day double blind study of healthy men who ingested a controlled diet of foods naturally low or high in selenium (Hawkes et al. 2001). Eleven subjects were fed 0.0006 mg selenium/kg/day in the diet for 21 days (baseline period), followed by 0.0002 mg/kg/day (6 subjects) or 0.004 mg/kg/day (5 subjects) for the following 99 days. The results show that the high-selenium diet was not immunotoxic and had some mild and transient immune-enhancing properties. There is an indication that selenium supplementation increased the secondary immune response to diphtheria vaccine when rechallenged at the end of the study. The mean within-subject ratio of diphtheria antibody titers 14 days after reinoculation (day 116) to titers 14 days after the initial challenge at baseline (day 19) was significantly greater in the high-selenium group than in the low-selenium group (2.7±1.8-fold vs. 0.9±0.6-fold, p=0.03). Lymphocyte counts were significantly increased in the high-selenium group on day 45, but not at the end of the study, and there were no clear effects of selenium on numbers of activated or cytotoxic T-cells. The proliferative response of peripheral lymphocytes to stimulation with pokeweed mitogen (a B-cell mitogen) was significantly higher in the high-selenium group than in the low-selenium group on days 45 and 72, although not at the end of the study. There was no selenium-induced lymphocyte proliferation in response to T-cell mitogens (phytohemagglutinin or concanavalin A), or changes in lymphocyte phenotypes, serum immunoglobulins (IgA, IgG, IgM), complement fractions, natural-killer cell activity, delayed-type hypersensitivity skin responses to seven recall antigens (tuberculin purified-protein derivative, mumps, tetanus toxoid, candida, trichophyton, streptokinase streptase, and coccidioidin), or antibody responses to diphtheria-tetanus and influenza vaccines. This study was designed as a nutritional study and not as a toxicological study, as the selenium intake levels were well below the tolerable upper limit level (~5.7 µg Se/kg/day) recommended by the Food and Nutrition Board (NAS 2000).

Other human studies also indicate that selenium contributes to enhancing immune function (Baum et al. 1997; Kiremidjian-Schumacher et al. 1994; Peretz et al. 1991). Lymphocyte response was enhanced by dietary selenium, as measured by the T-lymphocyte proliferative response to pokeweed mitogen in elderly people taking a selenium-enriched yeast supplement (0.0014 mg/kg/day for 6 months) (Peretz et al. 1991). This finding is similar to results of the Hawkes et al. (2001) study summarized above, although it was noted that the elderly as a group generally tend to have both lower blood selenium concentrations and lower lymphocyte proliferation than the general population. Dietary supplementation with approximately 0.001 mg selenium/kg/day (as sodium selenate) for 8 weeks caused increased proliferation of active T

3. HEALTH EFFECTS

cells in a group of 11 volunteer subjects (Kiremidjian-Schumacher et al. 1994). The lymphocytes in the exposed subjects had an increased response to stimulation with alloantigen and developed into cytotoxic lymphocytes capable of destroying tumor cells. There was a 118% increase in cytotoxic lymphocyte-mediated tumor cytotoxicity, as well as an 82.3% increase in natural killer cell activity, compared to baseline values. The selenium supplementation regimen used in this study did not cause significant increases in selenium levels in the plasma or red blood cells.

Immune function was evaluated in 40 volunteers from a Finnish population with low blood selenium concentrations that were supplemented with selenium or placebo for 11 weeks (Arvilommi et al. 1983). At the end of the supplementation period, plasma selenium levels were 74 µg/L in the placebo group and 169 µg/L in the supplemental group. Intracellular killing of *Staphylococcus aureus* by granulocytes was slightly lower in the placebo group than in the selenium group (77.2% compared to 85.2%, $p < 0.05$). No significant changes were observed in phagocytosis, chemotactic factor generation, antibody or leukocyte migration inhibitory factor production by lymphocytes, or proliferative responses to the T-cell mitogens phytohemagglutinin or concanavalin A.

There is evidence that selenium has a role in protecting patients with HIV virus. Immune parameters and nutrients known to affect immune function were evaluated at 6-month intervals in 125 HIV-1-seropositive drug-using men and women (Baum et al. 1997). When all factors that could affect survival were considered jointly, only reduced number of CD4 helper T cells over time and selenium deficiency were significantly associated with mortality. Low plasma selenium (< 85 µg/L) represented a significantly greater risk factor for mortality than low helper T cell counts, and conferred a more significant risk than any other nutrient studied, indicating that selenium-deficient HIV patients were more likely to die from HIV infection than those with adequate levels of selenium.

Studies of mice, rats, and cattle suggest that exposure to high doses of sodium selenite, but not selenomethionine, may reduce immunological responses (Johnson et al. 2000; Koller et al. 1986; Raisbeck et al. 1998; Yaeger et al. 1998). BALB/c mice (five males/group) were exposed to drinking water containing 0, 1, 3, and 9 ppm selenium as sodium selenite (0.024, 0.17, 0.38, and 0.82 mg selenium/kg/day) or seleno-L-methionine (0.024, 0.17, 0.47, and 1.36 mg selenium/kg/day) for 14 days (Johnson et al. 2000). The mice exposed to sodium selenite showed significant decreases in the relative spleen weight at 9 ppm and the relative thymus weight at 3 and 9 ppm. The number of splenocytes in the spleens of the 9 ppm group was reduced by 62%. Single-cell splenocyte cultures were made from the spleens of treated animals and used to determine the effects of selenium treatment on mitogen-induced

3. HEALTH EFFECTS

lymphocyte blastogenesis and cytokine production. Cultured splenic lymphocytes from mice exposed to 9 ppm selenium as sodium selenite showed a significant (260%) increase in the basal rate of proliferation and a nonsignificant increase in mitogen-induced proliferation. Exposure to 9 ppm selenium as sodium selenite also produced a significant increase in the amount of tumor necrosis factor α (TNF α) and interleukin-1 β (IL-1 β) produced by lipopolysaccharide (LPS)-stimulated splenic macrophages. However, the results of this experiment must be interpreted with caution as treatment with 9 ppm selenium as sodium selenite also produced a large and statistically significant decrease in food (21%) and water (43%) consumption, so that some of the effects observed (e.g., changes in organ weights) may reflect effects of dehydration rather than selenium toxicity. In contrast, the similar groups of mice treated with up to 9 ppm selenium as seleno-L-methionine (up to 1.36 mg selenium/kg/day) showed no significant changes in body weight gain, organ weights, water consumption, or food consumption compared with controls. There were no changes in the basal or mitogen-stimulated lymphocyte proliferation following treatment with seleno-L-methionine, and no alteration in the production of TNF α or IL-1 β from splenic macrophages was observed.

Another study in BALB/c mice examined the effects of consumption for 47 days of drinking water containing 7 ppm selenium as selenocystine, selenomethionine, or sodium selenite on immune function (Raisbeck et al. 1998). On the 14th day of the experiment, the mice received a subcutaneous injection of ovalbumin (OVA). Examination of mitogen-stimulated blastogenesis, B-cell function, and IgG concentrations at the end of the experimental period showed a significant decrease in B-cell function for mice treated with the two organic forms of selenium and a significant reduction in the concentration of OVA-specific antibodies for animals treated with any of the three forms of selenium. Total IgG concentration and OVA-stimulated blastogenesis did not vary between groups.

Rats given sodium selenite in drinking water at 0.7 mg selenium/kg/day for 10 weeks exhibited reduced humoral antibody (IgG) production in response to an administered antigen, and reduced prostaglandin synthesis, but there was no effect on natural killer cell (NKC) cytotoxicity (Koller et al. 1986). At lower doses (0.07 or 0.28 mg selenium/kg/day), NKC cytotoxicity was significantly increased, enhancing the immune response to antigenic stimulation, although the delayed-type hypersensitivity (DTH) and prostaglandin E₂ synthesis were significantly reduced. Selenium administration did not affect the ability of resident peritoneal cells to produce interleukin IL-1. Given the enhanced NKC activity at 0.07 and 0.28 mg selenium/kg/day, but not at 0.7 mg selenium/kg/day, and given the reduced antibody and prostaglandin synthesis at 0.7 mg selenium/kg/day, the dose of 0.7 mg selenium/kg/day is identified as

3. HEALTH EFFECTS

the lowest LOAEL. A NOAEL cannot be identified because of the conflict between enhanced NKC activity and reduced DTH and prostaglandin E₂ synthesis occurring at the same dose levels in this study. Antibody responses to ovalbumin were significantly lower in five male antelope (*Antilocapra americana*) fed a diet containing 15 ppm selenium (a mixture of alfalfa and hay naturally high in selenium) for 164 days than in controls fed a similar diet containing only 0.3 ppm selenium, but there was no difference in total globulin concentration between groups (Raisbeck et al. 1996). No clinical signs of selenosis or treatment-associated lesions were observed in these animals.

Treatment of steers with selenomethionine or selenite in food at doses up to 0.808 mg selenium/kg/day for 120 days produced symptoms of selenosis (hoof lesions), but did not produce any changes in the weight or histology of the spleen or thymus or in the histology of the lymph nodes (O'Toole and Raisbeck 1995).

Leukocyte function was significantly reduced in pregnant cows supplemented with 0.135 mg/kg/day selenium for 3 months from diets that contained 0.25 (control), 6, or 12 ppm selenium as sodium selenite. Treated animals showed a significant decrease in forced antibody production and a depression in mitogenic response compared with controls (0.005 mg selenium/kg/day) (Yaeger et al. 1998). No clinical signs of selenium toxicosis were observed in any of the cows during the experiment.

As selenium can enhance some immune system functions, selenium may have a normal physiological function in the immune system. This is supported by an 8-week study in which treatment of mice with selenium as sodium selenite (0.33 mg selenium/kg/day, dietary) resulted in enhanced ability of cytotoxic T-lymphocytes to destroy tumor cells (Kiremidjian-Schumacher et al. 1992).

Selenium appeared to play a protective role against viral infection in rats (Beck et al. 1995). When selenium-deficient rats were inoculated with a benign strain of Coxsackie's virus (CVB3/0), six separate point mutations were identified with the progression of virulence, causing myocarditis. Coxsackie's virus appears to act as a cofactor in the development of the myocarditis; this was shown when the virus was isolated from blood and tissue of people with Keshan disease (a cardiomyopathy particularly prevalent in selenium-deficient growing children and women of child-bearing age).

No studies were located concerning immunological or lymphoreticular effects in humans or experimental animals following oral exposure to selenium sulfide or selenium disulfide.

3. HEALTH EFFECTS

The highest NOAEL values and all LOAEL values from each reliable study for immunological effects following oral exposure to selenium or selenium compounds for each species and duration category are recorded in Table 3-2 and plotted in Figure 3-2.

3.2.2.4 Neurological Effects

Following acute oral exposure to selenium compounds in humans, aches and pains and irritability (Civil and McDonald 1978), as well as chills and tremors (Sioris et al. 1980) have been reported. The dizziness associated with selenium inhalation exposure has not been documented after selenium ingestion.

In a 1964 study, Rosenfeld and Beath reported listlessness, a general lack of mental alertness, and other symptoms of selenosis in a family exposed for approximately 3 months to well water containing 9 mg selenium/L (0.26 mg selenium/kg/day from drinking water). All of the symptoms resolved after use of the seleniferous water was discontinued. Because Rosenfeld and Beath (1964) did not estimate the family's exposure to dietary selenium, it is not possible to identify the total daily selenium dose associated with the symptoms of selenosis in this family.

In a dietary study of 11 men in a metabolic unit, selenium intake (80 µg/day for the first 21 days, then either 13 [n=6] or 356 [n=5] µg/day for 14 weeks) was reported to have no significant effect on mood, as measured using the Bi-Polar form of the profile of mood states (POMS) (Hawkes and Hornbostel 1996). However, subjects with initially low selenium levels did show significantly greater decreases in mood scores during selenium depletion.

In areas of the People's Republic of China where populations suffer from chronic selenosis, peripheral anesthesia and pain in the limbs were reported (Yang et al. 1983). In extreme cases, exaggerated tendon reflexes, convulsions, and some paralysis and hemiplegia occurred (Yang et al. 1983). These latter cases were associated with an estimated daily dietary intake of selenium of at least 3.22 mg selenium/person/day, averaging 4.99 mg selenium/person/day (Yang et al. 1983). Assuming a weight of 55 kg for Chinese men (Yang 1989b), these dietary levels represent 0.027 mg selenium/kg/day and 0.09 mg selenium/kg/day, respectively. In another high selenium area, no neurological effects were observed in individuals who consumed up to 1.51 mg selenium/day (0.027 mg/kg/day) (Yang et al. 1983). Danish geriatric patients with a mean age of 75.3 years were given daily either a placebo or an antioxidant cocktail containing 0.004 mg/kg/day of selenium as L-selenomethionine along with zinc, vitamins C, A,

3. HEALTH EFFECTS

B6, and E, and gamma-linolenic acid. After 1 year, whole blood selenium concentrations increased in the treated group, and slight but significant improvements in psychological scores were observed (Clausen et al. 1989). Because a mixture of nutrients was administered, the improvement in the patients cannot be attributed to selenium. People living on ranches with high selenium soils where selenium toxicity in livestock had historically been observed were compared to randomly selected residents in Wyoming and South Dakota. Daily selenium intake was measured by analysis of duplicate food portions. Subjects received a complete physical exam with a symptom questionnaire and laboratory tests. There were no biologically significant changes in clinical signs or blood chemistry. Calculated doses ranged from 0.001 to 0.01 mg selenium/kg/day in the diet (Longnecker et al. 1991).

An increased incidence (4 observed cases, 0.97 expected, standardized incidence ratio=4.14, 95% confidence interval [CI]=1.13–10.60) of amyotrophic lateral sclerosis, a human motor neuron disease of unknown origin, was reported for a cohort of 5,182 residents of Reggio Emilia, Italy who had been exposed to drinking water containing increased selenium (7–9 µg/L) from 1972 to 1988, compared with the incidence among residents of the surrounding area who had received municipal water containing <1 µg/L selenium (Vinceti et al. 1996). A subcohort of 2,065 of these individuals who had been exposed from 1974 (the earliest date for which a chemical analysis of the municipal tap water was available) was also examined and found to have an increased incidence ratio (4 observed cases, 0.47 expected, standardized incidence ratio=8.59, 95% CI=2.34–21.98). However, the study is limited by a water level of selenium that is not generally considered to be high, a lack of individual measurements of selenium exposure, and insufficient information on confounding variables. The lack of data on selenium status indicates that the study found a correlation but not causation.

In a 30-day study of the administration of L-selenomethionine to long-tailed macaques, severe hypothermia was observed in two of five animals administered 0.12 mg selenium/kg/day, but not in any of the eight animals receiving 0.08 mg selenium/kg/day (Cukierski et al. 1989). However, the increased incidence of hypothermia was not statistically significant. Following 1 week of treatment, all animals administered L-selenomethionine, including the two macaques treated with 0.01 mg selenium/kg/day, exhibited increased drowsiness and lethargy (Cukierski et al. 1989).

Symmetrical focal poliomyelomalacia and other forms of paralysis were seen in swine exposed to 0.58–2.1 mg selenium/kg/day after both acute and intermediate exposures (Baker et al. 1989; Goehring et al. 1984; Harrison et al. 1983; Mihailovic et al. 1992; Panter et al. 1996; Penrith and Robinson 1996; Stowe et al. 1992; Wilson et al. 1983, 1988, 1989). This lesion was noted in animals that showed ataxia,

3. HEALTH EFFECTS

inability to stand, and paralysis of the hind limbs. Additionally, bilateral lesions were noted in the ventral horns of the cervical and lumbar/sacral intumescences of the spinal cord. Necrosis and cavitation were evident in the larger lesions (Harrison et al. 1983). Bilateral lesions were also observed in several nuclei of the brain stem and in the reticular formation (Wilson et al. 1983). Wilson et al. (1983) reproduced the syndrome in growing pigs by feeding them sodium selenite at 50 mg selenium/kg in the diet for 20–40 days. The study authors did not provide sufficient information to calculate doses on a mg selenium/kg body weight basis, but assuming that young swine consume approximately 4% of their body weight each day, this dose was approximately 2.1 mg/kg/day.

In a study of weaned 5-week-old pigs, a dose of 1.3 mg selenium/kg/day given as sodium selenite in capsules killed all eight pigs within 10 days. Histopathological lesions were found in the brain and spinal cord (Wilson et al. 1989). In a study in which pigs were fed 1.25 mg selenium/kg/day in the form of *A. bisulcatus*, D,L-selenomethionine, or selenate, the selenium in *A. bisulcatus* was the most potent neurotoxin, resulting in complete paralysis in four of five pigs after 5 days of treatment, and in the last pig after 3 weeks of treatment (Panter et al. 1996). In pigs fed selenate, three of five developed complete paralysis, and one pig developed posterior paralysis after 4–21 days of treatment. Although D,L-selenomethionine resulted in the greatest incidence of selenosis, it was the least potent neurotoxicant, resulting in posterior paralysis in two of five pigs after 9 and 24 days of treatment; the pigs that did not develop paralysis were fed D,L-selenomethionine for approximately 31 days. The form of selenium in *A. bisulcatus* is unknown, although Panter et al. (1996) indicate that it is nonprotein.

It has long been believed that the blind staggers syndrome in livestock results from consumption of plants high in selenium (100–10,000 mg selenium/kg plant) (Rosenfeld and Beath 1964). These plants, which include *A. bisulcatus*, are known as selenium-indicator plants. “Blind staggers” is characterized by impaired vision, aimless wandering behavior, reduced consumption of food and water, and finally paralysis and death (Rosenfeld and Beath 1964; Shamberger 1986). Trembling of the skeletal muscles was observed in steers fed sodium selenite mixed in the feed at doses between 0.6 and 1.1 mg selenium/kg/day (Maag et al. 1960). At necropsy, two of six steers exhibited neuronal degeneration of the cerebral and cerebellar cortices. However, more recent studies in which cattle were treated with known amounts of selenium have not replicated these effects, and it is likely that “blind staggers” is not solely the result of selenium toxicity, but may also be attributable to other unidentified causes. For example, treatment of 20 steers with selenomethionine or selenite in food at doses up to 0.808 mg selenium/kg/day for 120 days produced symptoms of selenosis (hoof lesions), but did not produce any

3. HEALTH EFFECTS

neurological signs associated with “blind staggers” or any treatment-related changes in the histology of the central nervous system (O’Toole and Raisbeck 1995).

Neurological effects have also been reported for mice after acute or intermediate exposures to selenium. A single oral dose of selenium dioxide dissolved in water given to mice at 1/10th the LD₅₀ (1.7 mg/kg) caused moderate reductions in alertness, spontaneous activity, touch response, muscle tone, and respiration. Pentobarbital sleeping time was also significantly increased, and there was moderate hypothermia (Singh and Junnarkar 1991). Brain tissue from male BALB/c mice administered sodium selenite or seleno-L-methionine in drinking water at 0, 1, 3, or 9 ppm selenium (sodium selenite: 0.03, 0.24, 0.58, or 1.34 mg selenium/kg/day; seleno-L-methionine: 0.03, 0.26, 0.63, or 1.96 mg selenium/kg/day) for 14 days was examined for changes in the concentrations of norepinephrine (NE), dopamine (DA), dihydroxyphenylacetic acid (DOPAC), homovanillic acid (HVA), serotonin (5-HT), and 5-hydroxyindolacetic acid (5-HIAA) (Tsunoda et al. 2000). Treatment with seleno-L-methionine produced no significant changes in the concentrations of any of the neurotransmitters or their metabolites. DOPAC, DA, and HVA were increased in the striatum of mice receiving 3 or 9 ppm selenium as selenite. The increase was significant at both concentrations for DOPAC and at 3 ppm (but not 9 ppm) for HVA, but was not significant at either concentration for DA. No changes were observed for levels of NE, 5-HT, or 5-HIAA levels in any brain region of mice treated with sodium selenite.

Exposure of female BALB/c mice to 0.21 mg selenium/kg/day for 6 months from diets containing selenium as sodium selenite resulted in significant changes in behavior during open field testing (Boylan et al. 1990). Open field testing measures the arousal level of small rodents and can differentiate between fear-related behavior and general arousal. Mice receiving excessive selenium had reduced sniffing behavior and exhibited greater activity entering more squares, and more interior squares than mice receiving normal selenium diets. These behaviors are indicative of a general state of arousal rather than fear-motivated activity.

No studies were located concerning neurological effects in humans or experimental animals following oral exposure to selenium sulfide or disulfide.

The highest NOAEL values and all LOAEL values from each reliable study for neurological effects following oral exposure to selenium or selenium compounds for each species and duration category are recorded in Table 3-2 and plotted in Figure 3-2.

3. HEALTH EFFECTS

3.2.2.5 Reproductive Effects

No studies were located regarding adverse effects on human reproduction following oral exposure to elemental selenium or to selenium compounds. Associations between high seminal plasma selenium and impaired sperm count or motility have been inconsistently observed in humans (Bleau et al. 1984; Hansen and Deguchi 1996; Roy et al. 1990). A 120-day double blind experimental study found no adverse changes in sperm indices or reproductive hormone in men (20–45 years old) who consumed a controlled diet of foods naturally high or low in selenium (Hawkes and Turek 2001). Eleven subjects were fed a diet that provided 0.0006 mg selenium/kg/day for the first 21 days of the study, followed by diets providing 0.0002 mg selenium/kg/day (6 subjects) or 0.004 mg selenium/kg/day (5 subjects) for 99 days. Semen quality (sperm concentration, semen volume, sperm total number, fraction motile sperm, percent progressive sperm, mean forward velocity, and various sperm morphology parameters), reproductive hormone levels (serum testosterone, follicle-stimulating hormone, luteinizing hormone, prolactin, estradiol, and progesterone), and thyroid hormone levels (serum T₃ and TSH) were evaluated during weeks 3 (baseline values), 8, and 17 (ending values).

Selenium levels in blood plasma began to change within 3 days of starting the low- and high-selenium diets and progressively continued throughout the study (Hawkes and Turek 2001). By week 17, mean plasma selenium concentrations had increased by 109% in the high-selenium group and decreased by 38.5% in the low-selenium group. A similar pattern of changes occurred in seminal plasma selenium, although selenium levels in sperm did not change significantly in either group. Mean sperm motility was significantly different in the low-selenium subjects and high-selenium groups at week 13, but not at weeks 8 or 17. The fraction of motile sperm increased an average of 10% in the low-selenium group by week 13, and was essentially the same as the baseline value at week 17. Sperm motility decreased an average of 32% in the high-selenium group at week 13, and ended 17% lower than baseline value at week 17. ANOVA showed a significant main effect of dietary selenium on sperm motility, as well as a significant selenium x time interaction, indicating that the group responses diverged over time. Baseline and ending motile sperm fractions in the high-selenium group were 0.588 ± 0.161 and 0.488 ± 0.193 , respectively; $\geq 50\%$ motility is considered normal (FDA 1993). The decrease in sperm motility in the high-selenium group cannot be clearly attributed to selenium because the effect was not consistent over the duration of exposure, is unlikely to be adverse because it is at the low end of the normal range, and is not accompanied by any significant changes in other indices of sperm movement (progression or forward velocity), or sperm numbers or morphology. Additionally, there were no effects of selenium on serum

3. HEALTH EFFECTS

levels of reproductive hormones, and changes in thyroid hormones, which could affect sperm function, were not outside normal ranges (see Endocrine Effects in Section 3.2.2.2).

A nonsignificant increase in spontaneous abortions (relative risk [RR]=1.73; 95% CI=0.62–4.80) was reported among births in the municipality of Reggio Emilia, Italy, where women had been exposed to drinking water containing 7–9 ug/L levels of selenium (as selenate, reported estimated intake 10–20 ug/day) between 1972 and 1988 (Vinceti et al. 2000a). This study is limited by a level of selenium in water that is not considered high, lack of data on selenium status, and insufficient information on confounding variables. Selenium deficiency has been implicated as a risk factor for recurrent miscarriage in humans (Al-Kunani et al. 2001; Barrington et al. 1996, 1997; Güvenc et al. 2002; Kumar et al. 2002).

Data from animal studies suggest that exposure to excessive selenium has adverse effects on testosterone levels and sperm production and increases the percentage of abnormal sperm (El-Zarkouny et al. 1999; Kaur and Parshad 1994; NTP 1994). A significant reduction (49%) in serum testosterone levels was reported for New Zealand white rabbits gavaged with 0.001 mg selenium/kg/day as sodium selenite once a week for 6 weeks (El-Zarkouny et al. 1999). The percentage of spermatozoa without an acrosome was also increased in treated rabbits compared with controls, but the difference was not significant. Sperm motility, ejaculate volume, sperm concentration, and total sperm output were all reduced by selenium treatment, but statistical analysis of these data was not presented.

Exposure of Wistar rats to 0.234 mg selenium/kg/day as sodium selenite in water produced testicular hypertrophy (Turan et al. 1999a). A dose-related increase in abnormal sperm and a decrease in live sperm were observed in wild-caught rats exposed to selenite in the diet at 0.1 and 0.2 mg selenium/kg/day (Kaur and Parshad 1994). The percentage of abnormal sperm was 3.9% at 0.1 mg/kg/day and 24.6% at 0.2 mg/kg/day. The abnormalities observed were principally in the midpiece region of the sperm, the region that contains a selenoprotein (Sunde 1990). Decreased sperm counts were observed in rats provided with selenate or selenite in drinking water for 13 weeks at a dose of 0.29 mg selenium/kg/day for selenate and a dose of 0.17 mg selenium/kg/day for selenite (NTP 1994). Effects on sperm were not observed in mice treated with selenate or selenite in the drinking water at doses up to 5.45 mg selenium/kg/day for selenate or up to 3.31 mg selenium/kg/day for selenite (NTP 1994). The administration of 1.05 mg selenium/kg/day as potassium selenate to rats in drinking water for 1 year did not affect male fertility (Rosenfeld and Beath 1954), and the administration of 0.57 mg selenium/kg/day as sodium selenate for three generations did not reduce male fertility in mice (Schroeder and Mitchener 1971b). A short-term reproductive study of the effects of sodium selenate in drinking water on rats at

3. HEALTH EFFECTS

doses (0.418 mg selenium/kg/day) that produced signs of systemic toxicity did not cause any increase in sperm abnormalities or lesions of the testis or epididymis (NTP 1996). Selenium administered in the diet or in drinking water over short exposure periods (e.g., 1 month) does not appear to affect the fertility of female animals unless the intake is sufficiently high to cause general toxicity (Nobunaga et al. 1979). Despite a small increase in the number of abnormal length estrous cycles, Nobunaga et al. (1979) found no adverse effect on the fertility of female mice from administration of sodium selenite at doses of 0.34 mg selenium/kg/day in drinking water for 30 days before mating and for 18 days during pregnancy. On the other hand, chronic exposure of mice and rats to otherwise nontoxic doses has been shown to reduce fertility and to reduce markedly the viability of the offspring of pairs that are able to conceive (Schroeder and Mitchener 1971b; Wahlstrom and Olson 1959b).

A study of supplementation of female pigs with 0.1 or 0.3 ppm selenium (doses not available) administered as a selenium-enriched yeast or sodium selenite in the diet, from 60 days before breeding until weaning found no adverse effects on reproductive performance (measured by number of offspring) or growth (Mahan and Kim 1996). In another study of the effect of selenium on fertility in pigs, females fed sodium selenite at 0.4 mg selenium/kg/day from 8 weeks of age exhibited reduced rates of conception and also produced offspring with significantly reduced birth weight and weaning weights in the first and second litters (Wahlstrom and Olson 1959b). An altered menstrual cycle was reported in monkeys administered 0.08 mg selenium/kg/day as L-selenomethionine for 30 days (Cukierski et al. 1989).

Vaginal cytology of female rats provided with drinking water containing selenate or selenite indicated that the rats spent more time in diestrus and less time in proestrus and estrus than the controls (NTP 1994). This effect occurred following treatment with 0.31 mg selenium/kg/day as selenate or 0.86 mg selenium/kg/day as selenite. The animals in these studies were not mated, so it is not known if the effects on the estrous cycle had any effect on fertility. Effects on the estrous cycle were not observed in mice treated with selenate or selenite in the drinking water at doses up to 7.17 mg selenium/kg/day for selenate, or at doses up to 3.83 selenium/kg/day for selenite (NTP 1994).

In a three-generation reproduction study, selenium administered as sodium selenate (0.57 mg selenium/kg/day) in the drinking water of breeding mice produced adverse effects on reproduction (Schroeder and Mitchener 1971b). The most notable observed effects included the failure of about half of the F3 generation pairs to breed successfully. In a two-generation study using rats, selenium administered as potassium selenate had no effect on reproduction at a dose of 0.21 mg selenium/kg/day for 1 year; however, decreased fertility and pup survival were noted at 1.05 mg selenium/kg/day (Rosenfeld and

3. HEALTH EFFECTS

Beath 1954). At 0.35 mg selenium/kg/day for 1 year, the number of young successfully reared by the females was reduced by 50%, and the body weight of the females was approximately 20% less than that of the control females (Rosenfeld and Beath 1954).

A short-term reproductive study of the effects of sodium selenate in drinking water on rats reported some female reproductive toxicity (reduced corpora lutea, reduced implants per litter, shorter estrous cycle), but only at doses (0.418 mg selenium/kg/day) that produced signs of severe maternal toxicity, including a large reduction in water consumption (NTP 1996).

In a review of selenium poisoning in domestic animals, Harr and Muth (1972) noted a decreased conception rate and an increased fetal resorption rate in cattle, sheep, and horses fed diets naturally containing organic selenium compounds at 25–50 mg selenium/kg diet. Assuming that large animals consume an amount of food equal to about 2–3% of their body weight daily, the doses would have been approximately 0.5–1.5 mg selenium/kg/day. These levels of selenium also produced other signs of toxicity, including hair loss, lameness, and degeneration and fibrosis of the heart, liver, and kidneys. In a case control study of 136 Holstein cows from four herds, an association of cystic ovaries with blood selenium concentrations >108 ng/mL was found (Mohammed et al. 1991). The concentration of progesterone in the milk was significantly higher in the controls than in the cows receiving selenium supplementation, but no information on the selenium dose was presented. No change in estrus cycle length, estrus behavior, progesterone, or estrogen profiles or pregnancy rate was observed in a study of the reproductive response of ewes fed alfalfa pellets containing sodium selenate (24 ppm selenium) or *A. bisulcatus* (29 ppm selenium) as a selenium source for 88 days, from >52 days before pregnancy up to day 28 of gestation (Panter et al. 1995). Doses could not be calculated as food consumption was not listed, and the paper states that the food supply was limited to match that of the group with the lowest intake.

The highest NOAEL value for reproductive effects following intermediate oral exposure to sodium selenite and all reliable LOAEL values for reproductive effects following intermediate or chronic oral exposure to selenium compounds other than selenium sulfide are recorded in Table 3-2 and plotted in Figure 3-2.

3. HEALTH EFFECTS

3.2.2.6 Developmental Effects

No studies have demonstrated that selenium or its compounds are teratogenic in humans. Robertson (1970) reported on the outcome of pregnancies in a laboratory in which workers handled sodium selenite. Of the five pregnancies, four ended in spontaneous abortion and one resulted in an infant with bilateral clubfoot. The urinary selenium levels in all subjects were similar to those in other individuals living in the same area. The limited number of cases, possible exposure to other toxic agents, and other confounding factors leave the relationship between sodium selenite and developmental effects inconclusive.

No significant increase in spontaneous abortions (RR=1.73; 95% CI=0.62–4.80) was reported among births in the municipality of Reggio Emilia, Italy, where women had been exposed to drinking water containing 7–9 µg selenium/L (as selenate) between 1972 and 1988 (Vinceti et al. 2000a). Body weight and length at birth were similar in infants of exposed and unexposed women, and no significant increase in the prevalence of congenital abnormalities was found for 353 infants of exposed mothers compared with the 14,481 births among unexposed women. This study is limited by a level of selenium in water that is not considered high, lack of data on selenium status, and insufficient information on confounding variables.

Zierler et al. (1988) performed a case control study of 270 children born in Massachusetts with severe congenital heart disease and 665 controls randomly selected from birth certificates. The study compared the selenium concentrations in the public drinking water supply used by the mothers close to the time of conception to the selenium concentrations in the water consumed by the controls. The results indicated that selenium exposure via drinking water was associated with beneficial effects, particularly a reduction in the risk of congenital heart defects (cono-truncal defects, ventricular septal defects, coarctation of the aorta, and patent ductus arteriosus), but many variables are unknown, including other possible confounders (no adjustment for age, parity, tobacco, alcohol, drug use, or socioeconomic status), other sources of selenium in the mothers' diet and environment, the amount of drinking water consumed, and the selenium concentrations in the water during the first trimester.

Excess selenium is a demonstrated teratogen in birds. However, there is no clear evidence linking selenium exposures to teratogenic effects in mammals. Several studies have documented the sensitivity of chick embryos to selenium poisoning. Hatchability of eggs is reduced by dietary levels of organic selenium in grain that are too low to cause toxicity in other farm animals. The eggs are fertile but often

3. HEALTH EFFECTS

produce grossly deformed embryos lacking eyes and beaks and having deformed wings and feet (Franke and Tully 1935; Franke et al. 1936; Gruenwald 1958; Palmer et al. 1973). Deformed embryos have also been produced by injection of aqueous sodium selenite or sodium selenate into the air cell of the normal, fertile eggs of chickens (Franke et al. 1936; Khan and Gilani 1980). The incidence of malformation among coot, duck, stilt, and grebe embryos from eggs of birds ingesting plant and other food from irrigation drainwater ponds in the San Joaquin Valley of California was much higher than expected (10–42%, depending on the species, versus <1% based on data from other areas) (Ohlendorf et al. 1986a, 1988). Selenium concentrations in these ponds were >0.3 mg/L.

The consumption of naturally high seleniferous diets by sheep (Rosenfeld and Beath 1964) and cattle (Dinkel et al. 1963) may interfere with normal fetal development and produce malformations. Malformations were associated with alkali disease and occurred at dietary levels that produced other toxic manifestations, but it is not clear if these reports took into account consumption of other toxic range plants. The specific selenium compound or compounds possibly associated with livestock developmental toxicity have not been identified. No change in the outcome of pregnancy was observed in a study of the reproductive response of ewes fed alfalfa pellets containing sodium selenate (24 ppm selenium) or *A. bisulcatus* (29 ppm selenium) as a selenium source for 88 days, from >52 days before pregnancy up to day 28 of gestation (Panter et al. 1995). All lambs appeared normal, and there was no significant difference in the number or weight of lambs born to treated and control ewes. Doses could not be calculated, as food consumption was not listed, and the paper states that the food supply was limited to match that of the group with the lowest intake.

In an intermediate-duration study, an increased number of deaths between birth and weaning, reduced birth weight, and reduced body weight at weaning were observed in offspring of pigs fed selenite at 0.4 mg/kg/day for an unstated period of time (Wahlstrom and Olson 1959b). Treatment of 15 pregnant cows with diets containing 0.25 (control), 6, or 12 ppm selenium (0.005, 0.135, or 0.265 mg Se/kg/day) as sodium selenite beginning at 80–110 days gestation and continuing for 3 months resulted in no abnormalities among the offspring apart from one calf in the 12 ppm group that was born weak and subsequently died (Yaeger et al. 1998). This calf had myocardial lesions similar to those described for selenium toxicosis and had markedly elevated hepatic selenium levels, although selenium levels in blood and hair of this calf and its dam were lower than average for the 12 ppm group.

In studies of laboratory mammals, the administration of inorganic selenium compounds at levels that are not maternally toxic has not produced terata (Bergman et al. 1990; Chiachun et al. 1991; Ferm et al. 1990;

3. HEALTH EFFECTS

NTP 1996; Poulsen et al. 1989; Rosenfeld and Beath 1954; Schroeder and Mitchener 1971b; Thorlacius-Ussing 1990). Ferm et al. (1990) administered a single dose of sodium selenate, sodium selenite, or L-selenomethionine (0, 1.8, 2.2, 2.7, 4.0, 5.0, or 5.9 mg selenium/kg/day) to pregnant Syrian hamsters on gestation day 8. Pathological examination of the fetuses on day 13 showed that the percentage of abnormal litters was significantly increased at doses of ≥ 2.7 mg/kg. Encephalocele was the major malformation noted, and incidences were as follows: 0/71 controls; 4/55 (7.3%) at 1.8 mg/kg; 1/49 (2%) at 2.2 mg/kg; 7/66 (10.6%) at 2.7 mg/kg; 15/70 (21.4%) at 4 mg/kg; 9/38 (23.7%) at 5 mg/kg; and 6/16 (37.5%) at 5.9 mg/kg. Nobunaga et al. (1979) found that administration of sodium selenite in drinking water at 0.34 mg selenium/kg/day for 30 days before mating and for 18 days during pregnancy slightly, but significantly, reduced fetal growth in mice. However, there was no effect on fetal growth in the same study at a dose of 0.17 mg selenium/kg/day. A short-term developmental study (from gestation day 6 until birth) of the effects of sodium selenate in drinking water on rats produced some developmental toxicity (decreased number of live births, reduced pup weight, increased gestation period), but only at doses (0.418 mg selenium/kg/day) that produced signs of severe maternal toxicity including a large reduction in water consumption (NTP 1996). Selenium administered as potassium selenate in drinking water to male and female rats at a dose of 1.05 mg selenium/kg/day for 1–8 months for two successive generations did not cause congenital malformations (Rosenfeld and Beath 1954). Similarly, administration of 0.57 mg selenium/kg/day as sodium selenate in the drinking water of breeding mice for three generations did not have teratogenic effects, although there was an increased incidence in fetal deaths, and a high proportion of the surviving offspring were runts (Schroeder and Mitchener 1971b).

Poulsen et al. (1989) demonstrated that pigs exposed to 42.4 mg/day of selenium as sodium selenite in feed throughout pregnancy produced normal litters, with no adverse effect on piglet survival, litter size, or body weight at birth. Body weights of the pigs during pregnancy were not provided, and therefore, mg/kg/day doses could not be calculated. Body weight gains of pigs fed selenium as selenite at a dose of 0.4 mg selenium/kg/day after weaning (duration not specified) were reduced (Wahlstrom and Olson 1959a). The reduction in body weight gain was greater among pigs from dams not fed selenium during gestation and lactation compared to pigs fed selenium (0.4 mg/kg/day) during gestation and lactation. Without providing data, the study authors indicated that there was a greater loss of pigs at birth and during lactation from sows fed selenium, which may have eliminated susceptible pigs.

In a teratology study of long-tailed macaques, no gross abnormalities or growth retardations were observed in fetuses from mothers administered L-selenomethionine at levels of 0.003, 0.025, 0.15, or

3. HEALTH EFFECTS

0.30 mg selenium/kg/day on gestational days 20–50 (10 animals per group); the mid and high doses were maternally toxic (Tarantal et al. 1991).

The highest NOAEL value and all reliable LOAEL values for developmental effects following intermediate or chronic oral exposure to selenium compounds are recorded in Table 3-2 and plotted in Figure 3-2.

3.2.2.7 Cancer

Early studies reporting that selenium was carcinogenic in mammals after being provided as seleniferous corn or wheat in the diet (Nelson et al. 1943), as sodium selenite or sodium selenate in drinking water (Schroeder and Mitchener 1971a), or as sodium selenate in the diet (Volgarev and Tscherkes 1967) were flawed. The majority of subsequent studies of humans and animals have revealed no association between selenium intake and the incidence of cancer (Azin et al. 1998; Beems 1986; Coates et al. 1988; Harr et al. 1967; Ma et al. 1995; Menkes et al. 1986; Ratnasinghe et al. 2000; Thompson and Becci 1979; Vinceti et al. 1995; Virtamo et al. 1987) or a clear chemopreventive association (Birt et al. 1982; Clark et al. 1996a, 1999; Finley et al. 2000; Ip 1981, 1983; Ganther and Lawrence 1997; Ip and Lisk 1995; Ip et al. 1996, 1997, 1998, 2000a, 2000b; Jiang et al. 1999; Ma et al. 1995; Medina and Shepherd 1981; Moyad 2002; Overvad et al. 1985; Schrauzer et al. 1976, 1977; Shamberger et al. 1976; Soullier et al. 1981; Thompson and Becci 1980; Woutersen et al. 1999; Yoshizawa et al. 1998). Some epidemiological and experimental evidence suggests that selenium exposure, under certain conditions, may contribute to a reduction in cancer risk (Clark et al. 1996a, 1999; El-Bayoumy 2001; Ganther 1999; Moyad 2002; Spallholz 2001; Yoshizawa et al. 1998), and the chemopreventive potential of supplemental selenium is currently under research (Clark et al. 1999; Duffield-Lillico et al. 2002; Reid et al. 2002).

The only selenium compound that has been shown to be carcinogenic in animals is selenium sulfide (NTP 1980c), although there is also some evidence for carcinogenicity due to ethyl selenac (selenium diethyldithiocarbamate) (Innes et al. 1969; NCI 1968). These compounds are very different chemically from the organic and inorganic forms found in foods and the environment. Human dietary studies generally do not identify the selenium form specifically; both organic (from grains and other plant and animal products) and inorganic (from drinking water) forms are ingested. Animal bioassays in which selenium was administered as sodium selenate, sodium selenite, or organic forms of selenium have all shown similar negative results.

3. HEALTH EFFECTS

Excess incidence of melanoma was reported for a cohort of 2,065 individuals that were exposed to 7–9 µg/L levels of selenium as selenate in the municipal water supply in Reggio Emilia, Italy from 1972 until 1988 (Vinceti et al. 1998). Eight individuals among the exposed cohort developed melanoma compared with 128 in the remainder of the municipal population (total number of individuals not given). The standardized mortality ratios (SMRs) were 5.0 (95% CI=1.6–12.0) for males and 3.2 (95% CI=1.0–7.7) for females. The authors estimate the general dietary intake of selenium in the area to be 45–50 µg/day and the excess selenium supplied in the contaminated tap water to be 10–20 µg/day. However, the study is limited by the fact that no individual measurements of selenium exposure were made, and individuals were classed as exposed or unexposed depending on their place of residence. The lack of data on selenium status indicates that the study found a correlation but not causation. Other limitations include a water level of selenium that is not generally considered to be high and insufficient information on confounding variables.

A study of the effects of nutritional supplementation with selenium found a significant reduction in overall cancer mortality and in the incidence of lung (RR=0.54, 95% CI=0.3–0.98, p=0.04), colorectal (RR=0.42, 95% CI=0.18–0.95, p=0.03), and prostate (RR=0.37, 95% CI=0.18–0.71, p=0.003) cancer (Clark et al. 1996a, 1999). The original intent of the study was to assess the effects of selenium supplementation on nonmelanoma skin cancer. Patients with a history of skin carcinoma (1,312 individuals) were randomized into two groups; one group received a selenium supplement of 200 µg/day, and the other received a placebo. Groups were treated for an average of 4.5 years and followed for an average of 6.5 years. Supplementation produced no difference in skin cancer incidence; however, secondary end point analyses of the data found a protective effect for selenium for the cancers described above. A reanalysis of the lung cancer data added eight cases to the selenium-treated group, four cases to the placebo group, and increased follow-up to 7 years (Duffield-Lillico et al. 2002; Reid et al. 2002). Selenium supplementation did not reduce lung cancer incidence in the full population (RR=0.70, 95% CI=0.40–1.21, p=0.18; hazard ratio [HR]=0.74, 95% CI=0.44–1.24, p=0.26), although a nominally significant decrease was observed among subjects with baseline plasma selenium concentrations in the lowest tertile (HR=0.42, 95% CI=0.18–0.96, p=0.04). The analysis for the middle and highest tertiles of baseline selenium level showed HRs of 0.91 and 1.25, suggesting that there was a trend toward a reduction in risk of lung cancer with selenium supplementation.

Supporting evidence for an antiprostata cancer effect of selenium was obtained for a nested case-control design within the Health Professional Follow-up study (Yoshizawa et al. 1998), which found that higher

3. HEALTH EFFECTS

prediagnostic selenium levels were associated with reduced prostate cancer incidence. This study included 33,737 male health professionals aged 40–75 years who provided toenail clippings in 1987. The cohort was assessed by questionnaire for incidence of new cases of prostate cancer from 1989 to 1994. Higher levels of selenium in toenail clippings were significantly associated with a reduced risk of prostate cancer. After controlling for factors such as a family history of prostate cancer, body mass index, calcium intake, lycopene intake, saturated fat intake, vasectomy, and geographical region, the odds ratio (OR) was 0.35 (95% CI=0.16–0.78, *p* for trend=0.03). Studies of selenium supplementation have generally shown a reduction in prostate cancer risk only in individuals who had lower levels of baseline plasma selenium, whereas subjects with normal or higher levels did not benefit and may have an increased risk for prostate cancer (Moyad 2002).

Epidemiological studies that focused on the selenium concentration of forage crops as an indicator of available dietary selenium indicated an inverse association between selenium levels and cancer occurrence, with few exceptions. In the United States, male mortality due to cancer of the tongue, esophagus, stomach, intestine, rectum, liver, pancreas, larynx, lungs, kidneys, and bladder was significantly lower in states with high selenium levels in forage crops (concentrations in excess of 0.10 mg selenium/kg) (Shamberger et al. 1976). For females in states with high selenium levels, significantly lower cancer death rates were found for cancer of the esophagus, stomach, intestine, rectum, liver, pancreas, lungs, bladder, thyroid, breast, and uterus (Shamberger et al. 1976). Only male and female mortality due to cancer of the skin and eye, male mortality due to cancer of the lip and aleukemic leukemia (a deficiency or absence of leukocytes in the blood due to leukemia), and female mortality due to dermal melanoma were associated with high selenium levels in forage crops. Many of the high selenium areas are in the southwestern portion of the United States, and therefore, exposures to ultraviolet light may have contributed to the skin cancers observed in these areas (Shamberger et al. 1976). In a comparison of selenium intake and cancer mortality rates in different countries, Schrauzer et al. (1977) detected a cancer chemopreventive association between the selenium content of the diet and age-corrected cancer mortality from leukemia and cancers of the intestine, rectum, breast, ovary, prostate, lung, pancreas, skin, and bladder.

In a case control study of lung cancer patients, Menkes et al. (1986) found that the risk of lung cancer was not associated with serum selenium levels (0.113 and 0.110 mg selenium/L in cases and controls, respectively), but was significantly increased with decreasing serum levels of vitamins A and E. The study authors suggested that high serum selenium levels were significantly associated with an increased incidence of squamous cell carcinoma as compared to other cellular tumor types, but the statistical

3. HEALTH EFFECTS

analysis used was flawed. In a region of China with high rates of stomach cancer and low intake of several micronutrients (selenium not specifically stated), an intervention trial in 29,584 adults for 5.25 years demonstrated a 21% decrease in stomach cancer in the randomly selected group receiving a nutritional supplement of beta carotene (15 mg/day), vitamin E (30 mg/day), and selenium (50 µg selenium/day as selenium yeast) (Blot et al. 1993). However, because the three nutrients were given in combination to a nutritionally deficient population, it is not possible to determine what part of this effect (if any) was due to selenium.

Low serum selenium levels have been associated with an increased incidence of cancer in some prospective epidemiological studies (Salonen et al. 1984, 1985; Willet et al. 1983). In the United States, Willet et al. (1983) found that the risk of cancer for subjects in the lowest quintile (fifth) of serum selenium concentrations (<0.115 mg selenium/L) was twice that of subjects in the highest quintile (>0.154 mg selenium/L). In Finland, Salonen et al. (1985) found the risk of fatal cancer for subjects in the lowest tertile (third) of serum selenium concentrations (<0.047 mg selenium/L) was 5.8 times higher than that of the remaining subjects. Mean serum selenium levels in Americans (0.129 mg selenium/L cases; 0.136 mg selenium/L controls) (Willett et al. 1983) are more than twice the mean serum selenium levels in the Finns (0.0505 mg selenium/L for cases; 0.0543 mg selenium/L for controls) (Salonen et al. 1984). Although the age-specific risk of fatal cancers in the two populations cannot be calculated from the data reported, the overall incidence of cancer in the 4-year Finnish study was less than half that in the 5-year U.S. study. In addition, other prospective studies of Americans have found no correlation between fatal cancer and blood selenium concentrations (Coates et al. 1988). Thus, one may not be able to predict relative cancer risks with serum selenium levels in one population based on data from another population.

A 9-year prospective follow-up study was conducted by Virtamo et al. (1987) on a group of men in Finland. At the beginning of the study, blood samples were taken as part of a study of coronary heart disease and other atherosclerotic diseases. Cancer data were collected from central registries for the years 1976 through 1983. The results indicated no association between low serum selenium levels (<0.045 mg selenium/L) and an increased risk of cancer. Evidence suggests that combined dietary deficiencies of vitamin E and selenium may be associated with increased cancer risk (Salonen et al. 1985).

Epidemiological studies of breast cancer have found inverse correlations, positive correlations, and no correlations between tissue selenium concentrations and cancer incidence (recently reviewed by Garland et al. 1993). In a case control study of plasma selenium and breast cancer in which the controls had benign breast disease, a preventive effect of selenium was found only among individuals who had higher

3. HEALTH EFFECTS

plasma selenium and were not taking selenium supplementation (Hardell et al. 1993). This effect was significant (odds ratio 0.38) at a serum selenium concentration range of 0.08–0.09 mg/L in women 50 years old or more. GPX activity in erythrocytes was not found to be a marker for the risk of breast cancer. A case control study of 162 cases of breast cancer in Dutch women did not find a significant difference in dietary, plasma, erythrocyte, or toenail selenium between cases and 529 controls when multivariate-adjusted odds ratios were calculated. Dutch women have lower selenium intake than women in the United States and one of the highest incidences of breast cancer in Western Europe. The authors of this study surmised that other studies reporting an inverse relationship between selenium levels and breast cancer may be seeing an effect of the cancer (e.g., decreased uptake of selenium or anorexia), rather than lower selenium level contributing to the development of cancer (van't Veer et al. 1990). Similarly, a large prospective study of 434 cases in the United States found no correlation between selenium content in nails, established as a long-term marker of selenium (Hunter et al. 1990a), and breast cancer (Hunter et al. 1990b). It is interesting to note that a more recent investigation of the same cancer cases found an inverse correlation between vitamin A (retinoids) in the diet and breast cancer (Hunter et al. 1993). Retinoids are believed to have chemopreventive activity (Clausen et al. 1989; Hunter et al. 1993). Although the data as a whole for breast cancer and tissue selenium concentrations do not support a clear chemopreventive effect for selenium, it is possible that very high selenium concentrations or very low selenium concentrations outside the ranges observed in these studies could play a role in human cancer risk (Garland et al. 1993).

There were several inadequacies in the early studies that reported carcinogenic effects in animals following oral administration of selenium-containing compounds. Nelson et al. (1943) (also reported as Fitzhugh et al. 1944) administered naturally seleniferous corn or wheat diets containing 5, 7, or 10 mg selenium/kg diet (0.25, 0.35, or 0.50 mg selenium/kg/day) to female rats for 2 years. Selenium administration produced high mortality (69%) in all treatment groups by the end of the first 12 months, and the first tumors appeared after 18 months of treatment. Tumors developed only in animals with cirrhotic livers, and the tumors were reported to be nonmalignant. The possible contribution of overt hepatotoxicity to the development of liver tumors is not known. The incidences of tumors in the surviving animals in the three dose groups were 6/25, 3/21, and 2/7, respectively. The investigators had difficulty discerning malignant from nonmalignant tumors, and most animals had died of cirrhosis of the liver before the appearance of liver tumors. These difficulties cast doubt on the conclusion of the investigators that selenium induced tumor formation in these rats.

3. HEALTH EFFECTS

A statistically significant increase was reported in the incidence of all tumors and malignant tumors in rats administered 0.28–0.42 mg selenium/kg/day as sodium selenite or sodium selenate in drinking water for a lifetime (Schroeder and Mitchener 1971a). Not all autopsied animals were examined histologically, however, and high mortality in all groups occurred as a result of a virulent pneumonia epidemic that occurred during the study. In addition, the statistical analysis failed to account for the fact that the selenium-treated rats lived longer than did the control rats. Analysis of the incidence of tumors among animals with equal longevities indicates that the incidence of tumors in the selenate-treated rats was not significantly different from that in the controls.

A series of dietary studies assessed the effects of various dietary supplements on selenium tumor induction in male rats (Vologarev and Tschertes 1967), but the conclusions that can be drawn from these experiments are limited since they did not include controls. Tumors (primarily liver) were found in 10/23 male rats administered sodium selenate in the diet at a dose of 0.34 mg selenium/kg/day for more than 18 months (Vologarev and Tschertes 1967). The first tumors appeared after 18 months of selenium administration, by which time, 43% of the animals had already died (group started with 40 animals). Tumors were also found in 3/16 male rats administered sodium selenate in the diet at an initial dose of 0.34 mg selenium/kg/day for 6 months, followed by 0.68 mg/kg/day until the animals' death (Vologarev and Tschertes 1967). In a third group of experiments, no tumors were found in 200 male rats administered sodium selenate in the diet (0.34 mg selenium/kg/day) for 26 months. However, there was very high mortality among these rats, and survival time was 10 months shorter than among the similarly fed animals in the first experiment. The authors noted that an additional 200 male rats were maintained in their laboratory during these experiments and fed stock rations. The life spans of these animals exceeded those used in the experiments and no tumors were found at autopsy.

More recent animal bioassays have failed to demonstrate any association between excessive selenium exposure and carcinogenesis. Chen et al. (2000) reported a significant increase in rat esophageal adenocarcinogenesis in response to supplementation with 0.06 mg selenium/kg/day as sodium selenite for 40 weeks. However, selenium supplementation has generally been shown to significantly inhibit tumors induced by chemicals, viruses, or ultraviolet light (Birt et al. 1982; Finley et al. 2000; Ip 1981, 1983; Ip and Lisk 1995; Ip et al. 1996, 1997, 1998, 2000a, 2000b; Jacobs 1983; Jacobs et al. 1977a, 1977b, 1979, 1981; Jiang et al. 1999; Medina and Shepherd 1981; Overvad et al. 1985; Schrauzer et al. 1976; Soullier et al. 1981; Thompson and Becci 1980; Woutersen et al. 1999). Results following administration of selenium as sodium selenate, sodium selenite, and organic forms of selenium are similar. Additional

3. HEALTH EFFECTS

research reviewed in El-Bayoumy (1991, 1995, 1997) indicates that synthetic organoselenium compounds may be more potent cancer preventive agents than selenate, selenite, or the selenoamino acids.

Two sources reported the results of a study of rats administered sodium selenate or sodium selenite in the diet for a lifetime (Harr et al. 1967; Tinsley et al. 1967). A vehicle control and two positive control groups (administered a known hepatocarcinogen, *N*-2-fluorenyl-acetamide [FAA]) were included. Mortality was high in the highest dose group (0.8 mg selenium/kg/day), and therefore, selenium administration was discontinued. Longevity was reduced in animals fed 0.4 mg selenium/kg/day, but not in the animals administered lower doses. Of the original 1,437 experimental animals, 1,126 were necropsied. Half of the 88 FAA-fed rats developed neoplasms, half of which were hepatic carcinomas, indicating that the strain of rat and dietary conditions were compatible with the development of hepatic carcinogenesis. The incidence of cancer of all types in the necropsied control rats (11 out of 482, or 2.3%) was somewhat higher than the incidence of cancer in the selenium-treated animals that were necropsied (9 out of 553, or 1.6%). A statistical analysis of the data from this study was not reported. Although the reduced longevity of animals administered 0.4 mg selenium/kg/day might have prevented the observation of some late-developing cancers, the large number of rats necropsied, the end points examined, and the doses administered provide credible evidence of the lack of carcinogenic potential of sodium selenate or selenite.

Mice were fed tortula yeast diets containing up to 1.0 mg selenium/kg diet (equivalent to 0.13 mg selenium/kg body weight/day) as sodium selenite for 2 weeks prior to a single application of 0.125 mg 7,12-dimethylbenz[*a*]anthracene (DMBA) to the skin or repeated daily applications of 0.25 mL of a 0.03% solution of benzo[*a*]pyrene in acetone for 27 weeks (Shamberger 1970). The highest dose of selenite used, 0.13 mg selenium/kg/day, significantly decreased the number of tumors induced by both aromatic compounds. No significant increase was found in the incidence of spontaneous tumors in mice following administration of 3 mg selenium/L in drinking water as either sodium selenite or sodium selenate for a lifetime (Schroeder and Mitchener 1972). This level corresponds to doses of 0.31–0.34 mg selenium/kg/day for the males and 0.42 mg selenium/kg/day for the females. The single dose administered, however, might not have been the maximal dose that could be tolerated. There were 7% more malignant tumors in the selenium-treated animals (13 out of 88 sectioned, or 15%) than in the controls (10 out of 119 sectioned, or 8%), but the difference was not statistically significant. The forms of selenium administered did not influence the incidence of tumors. In this study, only 88 out of 211 selenium-treated animals and 109 out of 209 control animals were examined histologically.

3. HEALTH EFFECTS

The only selenium compound that has been shown to be carcinogenic in animals is selenium sulfide (NTP 1980c), although there is some inconclusive evidence that ethyl selenac may also be carcinogenic (Innes et al. 1969; NCI 1968). A statistically significant increase in hepatomas (0/16 controls; 12/16 treated) was observed in male mice of one strain (C57BL/6 x C3H/Anf)_{F1}) receiving 2 mg selenium/kg as ethyl selenac, but not in male or female mice of another strain (C57BL/6 x AKR)_{F1}) receiving the same dose (Innes et al. 1969; NCI 1968).

Statistically significant increases in hepatocellular carcinomas and adenomas in rats and hepatic carcinomas and adenomas, as well as alveolar/bronchiolar carcinomas and adenomas, in female mice have been observed following chronic oral exposure to selenium sulfide (NTP 1980c). The incidence of hepatocellular carcinomas in rats was 1/50, 0/50, and 15/49 in males and 0/50, 0/50, and 21/50 in females at 0, 3, and 15 mg selenium sulfide/kg/day, respectively. In mice, the incidences of hepatocellular carcinomas and adenomas were 15/50, 14/50, and 23/50 in males, and 0/49, 2/50, and 25/49 in females at 0, 20, and 100 mg selenium sulfide/kg/day, respectively. Selenium sulfide is a pharmaceutical compound used in some antidandruff shampoos and is not administered orally. Because selenium sulfide is not absorbed through the skin, use of shampoos containing this compound should be safe, unless one intentionally consumes the product or has open cuts or sores on the scalp or hands. Chemically, selenium sulfide and ethyl selenac are very different from the organic and inorganic selenium compounds found in foods and in the environment.

In 1975, the International Agency for Research on Cancer (IARC) evaluated the literature relating selenium to carcinogenesis in both humans and animals. The Agency stated that the available data provided no suggestion that selenium is carcinogenic in humans (IARC 1975a), and IARC subsequently assigned selenium to Group 3: not classifiable as to its carcinogenicity to humans (IARC 1987). The forms of selenium considered included sodium selenate, sodium selenite, and the organic forms of selenium contained in plant materials. Separate evaluations of ethyl selenac and methyl selenac assigned them to Group 3, also (IARC 1975a, 1987). According to EPA, selenium is not classifiable as to its carcinogenicity in humans and is rated as Group D (IRIS 2003). The evidence for selenium sulfide, however, is sufficient to classify it as Group B2 (probable human carcinogen) (IRIS 2003).

3. HEALTH EFFECTS

3.2.3 Dermal Exposure**3.2.3.1 Death**

No studies were located concerning death in humans after dermal exposure to selenium or selenium compounds. In a range-finding study using mice dermally exposed to selenium sulfide for a maximum of 17 applications, 8 out of 20 animals died at 714 mg selenium sulfide/kg (NTP 1980a). However, the effects noted in this study were equivocal since there was no indication that the application sites were covered to prevent ingestion. Further, severe skin damage developed, and this may have led to direct systemic absorption of the compound.

3.2.3.2 Systemic Effects

No studies were located concerning respiratory, cardiovascular, gastrointestinal, hematological, musculoskeletal, hepatic, renal, endocrine, or body weight effects in humans or other animals following dermal exposure to selenium or selenium compounds.

Dermal Effects. Skin toxicity in humans, notably skin rashes, burns, and contact dermatitis, has been reported for both acute and chronic exposure to selenium fumes and acute exposures to selenium dioxide (Middleton 1947). No effects were detected in a study of eight women exposed daily for 2 weeks to an experimental sunscreen lotion containing up to 0.003 mg/kg/day selenium as L-selenomethionine (Burke et al. 1992a). A case report of a severe allergic skin response following intermediate exposure to sodium selenite (Senff et al. 1988) is discussed under immunological effects. Single topical exposures to selenious acid resulted in purpura, inflammation around hair follicles, and a pustular rash with some ulceration in exposed workers (Pringle 1942). However, these effects may have been due to the caustic effects of the acid. A single case report of hyperpigmentation and hair loss after use of a shampoo containing 1% selenium sulfide was located (Gillum 1996), but a study of the efficacy of an antidandruff shampoo containing 1% selenium sulfide found no adverse effects after 6 weeks of use by 150 individuals (Neumann et al. 1996).

Application of 100 μ L of a lotion (oil-in-water emulsion) containing 0.02% selenium as selenomethionine 3 times a week to the shaved backs of mice for 39 weeks did not result in significant dermal effects (Burk

3. HEALTH EFFECTS

et al. 1992b). Dermal effects were also not observed in hairless mice treated in the same manner for 49 weeks.

In mice, topical application of selenium sulfide resulted in erythema and skin irritation at 29 mg/kg, acanthosis at 143 mg/kg, and severe skin damage at 714 mg/kg (NTP 1980a).

Ocular Effects. No studies were located regarding ocular effects in humans after dermal exposure to selenium or selenium compounds. However, older reports on eye contact with selenium or selenium compounds indicate that acute exposure to selenium dioxide caused ocular and conjunctival irritation, and caused severe pain, lacrimation, blurred vision, and dulled corneas upon contact (Middleton 1947). Brief exposure to clouds of selenium fumes resulted in lacrimation, irritation, and redness of the eyes (Clinton 1947).

No studies were located regarding ocular effects in laboratory animals after dermal exposure to selenium or selenium compounds.

3.2.3.3 Immunological and Lymphoreticular Effects

A 1988 case report describes a female laboratory technician who developed severely pruritic vesicles between the fingers after 6 months of exposure to a medium containing selenium. After 2 years, the severity of the symptoms increased to include eczema on the face and neck, watering eyes, and two asthma attacks within a 2-month period. Sodium selenite or the medium containing selenium were the only positive patch tests (Senff et al. 1988).

No studies were located regarding immunological and lymphoreticular effects in laboratory animals after dermal exposure to selenium or selenium compounds.

No studies were located regarding the following health effects in humans or laboratory animals after dermal exposure to selenium or to selenium compounds:

3. HEALTH EFFECTS

3.2.3.4 Neurological Effects**3.2.3.5 Reproductive Effects****3.2.3.6 Developmental Effects****3.2.3.7 Cancer**

No studies were located regarding carcinogenic effects in humans after dermal exposure to selenium or selenium compounds.

The results of most animal studies have not indicated that elemental selenium or selenium compounds are carcinogenic when topically applied to the skin of experimental animals (NTP 1980a, 1980b; Shamberger 1970). Several studies indicate that selenium compounds may protect against effects of known dermal carcinogens (polynuclear aromatic hydrocarbons [PAHs] and ultraviolet light). Shamberger (1970) reported that topical application of a solution containing 0.0005% sodium selenide significantly reduced the number of dermal papillomas induced by painting DMBA on the shaved backs of mice. More recently, Burke et al. (1992b) reported orally and topically administered l-selenomethionine decreased ultraviolet burns and skin cancer in albino (BALB:c) and hairless pigmented (Skh:2) female mice.

Only one study was found in which tumor development was reported after topical administration of selenium ointment (Tsuzuki et al. 1960). An unspecified number of mice were exposed to an unspecified amount of ointment containing 2.5, 5.0, 7.5, or 10% elemental selenium 6 days/week for an unspecified period of time by topical administration to hip skin. Tumors developed on the base of the necks of two female mice. Ingestion of the compound was possible because the animals may have licked the ointment. No other details were reported. The study is inconclusive because of the lack of controls, short duration, and inadequate description of the study protocol and results.

The National Toxicology Program (NTP 1980a) conducted a dermal application study of selenium monosulfide. The compound was applied to the skin of groups of 50 male and 50 female Swiss mice at 0, 0.5, or 1.0 mg selenium sulfide/mouse, 3 days/week for 86 weeks. The application sites were not covered; therefore, ingestion of the test compounds was possible. The incidence of tumors in the treated groups did not differ significantly from that in the control group.

3. HEALTH EFFECTS

NTP (1980b) also tested Selsun, a prescription dandruff shampoo containing 2.5% selenium sulfide (also a mixture of the mono- and disulfides), for carcinogenic properties. Groups of 50 male and 50 female Swiss mice were dermally exposed to a 0, 25, or 50% solution of Selsun in distilled water 3 days/week for 86 weeks. These doses were equivalent to 0, 0.31, or 0.625 mg selenium sulfide/mouse/day. The incidences of alveolar or bronchiolar adenomas or carcinomas in male mice were significantly increased over vehicle control values, but not over untreated control values. There was no significant effect in female mice. Some ingestion of the compound was possible, because the application sites were not covered. Also, the male mice may have been susceptible to another ingredient in the shampoo (the chemical composition of the shampoo was not reported), or the bioassay may have been too short due to decreased survival to detect a carcinogenic effect in females. Male mice that received dermal application of slightly larger doses of selenium sulfide (NTP 1980a) did not develop significantly more cancers than the controls.

3.2.4 Other Routes of Exposure

Endocrine Effects. Intraperitoneal injection of diabetic rats with sodium selenate has been reported to have insulin-like effects, producing a decrease in plasma glucose concentrations (McNeill et al. 1991). However, it is not clear that this is due to an effect of selenium on insulin metabolism, since food and water consumption were also decreased, and this is likely to have produced the decreased glucose levels.

Neurological Effects. Intraperitoneal injection of selenium (3.0 mg Se/kg as sodium selenite) into male Sprague-Dawley rats produced a significant increase (70%) in dopamine overflow from the striatum (as measured by an implanted dialysis probe) with a concomitant significant reduction in HVA levels (Rasekh et al. 1997). DOPAC levels were not changed. Direct infusion of 10 mM selenium into the striatum also produced a significant increase in dopamine overflow accompanied by slight, but significant decreases in HVA and DOPAC. Direct infusion of 10 mM selenium into the nucleus accumbens also produced a rapid and significant increase in dopamine overflow, but with no changes in DOPAC or HVA concentrations. The selenium induced changes in dopamine overflow were suppressed by the dopamine receptor agonist quinpirole.

3. HEALTH EFFECTS

3.3 GENOTOXICITY

Inorganic selenium compounds have been observed to have both genotoxic and antigenotoxic effects. The antigenotoxic effects generally occur at lower selenium exposure levels than the frank genotoxicity. This discussion will focus on genotoxic effects only. *In vitro* studies of the genotoxicity of selenium compounds are summarized in Table 3-4, and *in vivo* studies of the genotoxicity of selenium compounds are summarized in Table 3-5.

Selenium dioxide was found to be mutagenic in both the Ames and the VITO-TOX *Salmonella typhimurium* tests of genotoxicity (van der Lelie et al. 1997).

In general, sodium selenite and sodium selenate have produced mixed results in bacterial mutagenicity test systems (Table 3-4). Sodium selenite induced base-pair substitution mutations using *S. typhimurium* and was also positive in the transformation assay using *Bacillus subtilis* (Kramer and Ames 1988; Nakamuro et al. 1976; Noda et al. 1979). However, negative results have also been reported for sodium selenite both in *S. typhimurium* and the rec assay using *B. subtilis* (Lofroth and Ames 1978; Noda et al. 1979). Sodium selenate, on the other hand, has tested positive in *S. typhimurium* (base-pair substitution) and in the rec assay using *B. subtilis* (Lofroth and Ames 1978; Noda et al. 1979), but has tested negative using the transformation assay in *B. subtilis* (Nakamuro et al. 1976).

Results with mammalian cell systems are also mixed, although sodium selenite is more consistently genotoxic in these systems. Sodium selenite has been observed to induce unscheduled deoxyribonucleic acid (DNA) synthesis (UDS), chromosomal aberrations, and sister chromatid exchange in cultured human fibroblasts (Lo et al. 1978; Ray et al. 1978; Whiting et al. 1980); UDS in Chinese hamster V79 cells (Sirianni and Huang 1983); and chromosomal aberrations in cultured Chinese hamster ovary cells (Whiting et al. 1980). However, sodium selenate induced chromosomal aberrations in Chinese hamster ovary cells (Whiting et al. 1980) and UDS in Chinese hamster V79 cells (Sirianni and Huang 1983), but did not induce chromosomal aberrations in human leukocytes or cultured human fibroblasts (Lo et al. 1978; Nakamuro et al. 1976). A comparison of cytotoxicity and induction of tetraploidy in Chinese hamster V79 cells induced by sodium selenite or its major excretory product trimethylselenonium found that sodium selenite was about 1,000 times more cytotoxic than trimethylselenonium, but that neither compound produced a significant change in mitotic index (Ueda et al. 1997).

3. HEALTH EFFECTS

Table 3-4. Genotoxicity of Selenium *In Vitro*

Species (test system)	End point	Result		Reference
		With activation	Without activation	
Prokaryotic organisms:				
	Mutation			
<i>Salmonella typhimurim</i>	(Na ₂ SeO ₃)		–	Lofrothand
	(Na ₂ SeO ₄)	NT	+	Ames 1978
<i>S. typhimurim</i>	(SeO ₂)	NT	+	van der Lelie et al. 1997
<i>S. typhimurim</i> TA100	(Na ₂ SeO ₃)	NT	+	Noda et al.
<i>S. typhimurium</i> TA98, TA1537		NT	–	1979
<i>S. typhimurium</i> TA100	(Na ₂ SeO ₄)	NT	+	
<i>S. typhimurium</i> TA98, TA1537		NT	–	
<i>Bacillus subtilis</i> rec assay	(Na ₂ SeO ₃)	NT	–	Noda et al. 1979
<i>B. subtilis</i> rec assay	(Na ₂ SeO ₄)	NT	+	Kanematsu et al. 1980
	(SeO ₂)	NT	+	
<i>B. subtilis</i> transformation	(SeO ₂)	NT	+	Nakamuro et al. 1976
	(Na ₂ SeO ₃)	NT	+	
	(Na ₂ SeO ₄)	NT	–	
Eukaryotic organisms:				
Mammalian cells	Chromosomal aberrations			
Chinese hamster ovary	(Na ₂ SeO ₃)	NT	+	Whiting et al. 1980
	(Na ₂ SeO ₄)	NT	+	
Human leukocytes	(SeO ₂)	NT	+	Nakamuro et al. 1976
	(Na ₂ SeO ₃)	NT	+	
	(Na ₂ SeO ₄)	NT	–	
Human lymphocytes	(Na ₂ SeO ₄)	NT	+	Biswas 1997
Human lymphocytes	(Na ₂ SeO ₃)	NT	+	Biswas et al. 2000
	(Na ₂ SeO ₄)	NT	+	
Human lymphocytes	(Na ₂ SeO ₃)	NT	+	Khalil 1989
	(Selenomethionine)	NT	+	
Cultured human fibroblasts	(Na ₂ SeO ₃)	+	+	Lo et al. 1978
	(Na ₂ SeO ₄)	–	–	
	Tetraploidy			
Chinese hamster V79 cells	(Na ₂ SeO ₃)	NT	+	Ueda et al. 1997
	(Trimethylselenonium)	NT	+	
	DNA strand breaks			

3. HEALTH EFFECTS

Table 3-4. Genotoxicity of Selenium *In Vitro*

Species (test system)	End point	Result		Reference
		With activation	Without activation	
Mouse mammary carcinoma cells	(Na ₂ SeO ₃)	NT	+	Lu et al. 1995b
	(Na ₂ SeO ₄)	NT	+	
	(Methylselenocyanate)	NT	-	
	(Se-methylseleno-cysteine)	NT	-	
	Unscheduled DNA synthesis			
Cultured human fibroblasts	(Na ₂ Se)	NT	+	Whiting et al. 1980
	(Na ₂ SeO ₃)	NT	+	
	(Na ₂ SeO ₄)	NT	+	
	Sister chromatid exchange			
Cultured human fibroblasts	(Na ₂ SeO ₃)	NT	+	Ray et al. 1978
Human lymphocytes	(Na ₂ SeO ₃)	NT	+	Khalil 1989
	(Selenomethionine)	NT	+	
	(Selenocystine)	NT	+	Khalil 1994

- = negative result; + = positive result; DNA = deoxyribonucleic acid; NT = not tested; (Na₂Se) = sodium selenide; (Na₂SeO₃) = sodium selenite; (Na₂SeO₄) = sodium selenate; (SeO₂) = selenium dioxide

3. HEALTH EFFECTS

Table 3-5. Genotoxicity of Selenium *In Vivo*

Species (test system)	End point	Results	Reference
Human lymphocytes (Na ₂ SeO ₃)	Chromosomal aberrations, sister chromatic exchanges	–	Norppa et al. 1980a
Monkey (<i>Macaca fasciculari</i>) bone marrow (L-seleno- methionine)	Micronuclei	+ (adult toxic dose) – (fetal at maternally toxic doses)	Choy et al. 1989 Choy et al. 1993
Mouse bone marrow (Na ₂ SeO ₃) (Na ₂ SeO ₄)	Chromosome breaks and spindle disturbances	+ +	Biswas et al. 1997
Mouse bone marrow (Na ₂ SeO ₃) (Na ₂ SeO ₄)	Chromosome breaks and spindle disturbances	+ +	Biswas et al. 1999a
Mouse bone marrow (H ₂ SeO ₃) (Na ₂ SeO ₄)	Micronucleus induction	+ +	Itoh and Shimada 1996
Mouse bone marrow (H ₂ SeO ₃)	Micronucleus induction	+	Rusov et al. 1996
Rat bone marrow (Na ₂ SeO ₃)	Chromosomal aberrations	+	Newton and Lilly 1986
Rat bone marrow (SeS)	Chromosomal aberrations	–	Moore et al. 1996b
Rat bone marrow (SeS)	Micronucleus induction	+	Moore et al. 1996b
Rat spleen (SeS)	Chromosomal aberrations	–	Moore et al. 1996b
Rat spleen (SeS)	Micronucleus induction	–	Moore et al. 1996b
Rat lymphocytes (Na ₂ SeO ₃)	Chromosomal aberrations	–	Newton and Lilly 1986

+ = positive result; – = negative result

3. HEALTH EFFECTS

The addition of glutathione to test mixtures enhances the genotoxicity of sodium selenite, sodium selenate, and sodium selenide in bacterial test systems, indicating that production of a reactive species mutagenic for bacteria occurs via a reductive mechanism following concomitant exposure to these compounds (Whiting et al. 1980). This finding is supported by results in mammalian test systems. For example, in cultured human leukocytes, sodium selenite induces chromosome aberrations and sister chromatid exchanges (Nakamuro et al. 1976; Ray and Altenburg 1978; Ray et al. 1978). Sister chromatid exchange was not observed at similar sodium selenite concentrations in a human lymphoblastoid cell line; however, exchanges were observed when these same cells were incubated with sodium selenite and red blood cell lysate (Ray and Altenburg 1978). The observation that internal constituents of red blood cells may contribute to the genotoxicity of sodium selenite supports the suggestion that metabolism is involved in the production of an active species following exposure to sodium selenite in these test systems. The active species responsible for the genotoxic effects is not known.

At high concentrations, sodium selenite induces unscheduled DNA synthesis and chromosome aberrations in cultured human fibroblasts (Lo et al. 1978). The addition of a metabolic activator (S9 fraction) or glutathione increased both the number of aberrations and the toxicity of sodium selenite (Whiting et al. 1980) and sodium selenate (Lo et al. 1978; Whiting et al. 1980).

Sodium selenite, sodium selenide, methylselenocyanate, and Se-methylselenocysteine were all found to be cytotoxic to cells of a mouse mammary carcinoma line; however, only sodium selenite and sodium selenide induced DNA strand breaks (Lu et al. 1995b).

Selenomethionine (Khalil 1989) and selenocystine (Khalil 1994) have tested positive for sister chromatid exchanges in cultured human lymphocytes. Selenomethionine, sodium selenite, and sodium selenate tested positive for chromosomal aberrations in cultured human lymphocytes (Biswas 1997; Biswas et al. 2000; Khalil 1989). Sodium selenite was considerably more clastogenic than sodium selenate (Biswas et al. 2000).

The genotoxicity of selenium monosulfide was assessed in an *in vivo/in vitro* micronucleus and chromosome aberration assay in rats (Moore et al. 1996b). Male Wistar rats (4/dose) were administered 25, 50, or 100 mg/kg selenium monosulfide in corn oil. Negative control rats received corn oil by gavage and positive controls were injected intraperitoneally with 20 mg/kg cyclophosphamide. Animals were sacrificed 24 hours after treatment and the femur marrow and spleen were removed and cultured. Spleen

3. HEALTH EFFECTS

and marrow cultures were examined 24 or 48 hours after establishment, respectively. No increase in chromosome aberrations or micronucleus formation in cells from treated rats was observed.

Results of *in vivo* genotoxicity tests have been both negative and positive (Table 3-5). Chromosomal aberrations and sister chromatid exchanges in lymphocytes were not increased in nine neuronal ceroid lipofuscinosis patients treated with intramuscular sodium selenite injections or tablets (0.005–0.05 mg selenium/kg/day) for 1–13.5 months, or in five healthy persons given selenite (0.025 mg/kg/day) for 2 weeks (Norppa et al. 1980a). Among the treated patients, there was no distinction between route of exposure.

Compared to untreated controls, a significant increase in the number of micronuclei was observed in bone marrow cells of macaques treated by nasogastric intubation with L-selenomethionine at a dose of 0.24 mg selenium/kg/day for 15 days (Choy et al. 1989). No effect on the number of micronuclei was observed in macaques treated with L-selenomethionine at a dose of 0.12 mg selenium/kg/day for 19 days. A significant increase in the number of micronuclei in bone marrow cells was not observed in the offspring of macaques treated by nasogastric intubation with L-selenomethionine at a dose of 0.12 mg selenium/kg/day on gestation days 20–50 (Choy et al. 1993). The doses of L-selenomethionine used in these studies produced obvious signs of toxicity (loss of body weight, poor appetite, constipation, depression, weakness) in the macaques.

Chromosomal aberrations were not increased in the lymphocytes of rats given two intravenous doses of sodium selenite at 2.3–2.7 mg selenium/kg (Newton and Lilly 1986). Chromosomal aberrations in bone marrow cells were significantly increased in these rats, but the total dose of selenium was near the intravenous LD₅₀ for selenite, which has been reported as 5.7 mg selenium/kg in rats (Olson 1986).

Bone marrow cells of male mice gavaged with sodium selenate or sodium selenite showed a significant increase in chromosome breaks and spindle disturbances compared with untreated controls (Biswas et al. 1997, 1999a). The number of chromosomal aberrations increased with dose and was slightly greater with sodium selenite than with sodium selenate. A significant increase in micronucleus formation was observed in bone marrow cells of male mice intraperitoneally injected with selenous acid and in female mice intramuscularly injected with sodium selenite, but not in male mice intraperitoneally injected with sodium selenate (Itoh and Shimada 1996; Rusov et al. 1996).

3. HEALTH EFFECTS

Selenium appears to affect the ability of liver enzymes to activate some chemical mutagens. Studies in animals exposed orally to sodium selenite in the diet at doses between 0.05 and 0.125 mg selenium/kg/day indicate that selenium may inhibit the mutagenic effect of other chemical agents (Gairola and Chow 1982; Schillaci et al. 1982). In these studies, *S. typhimurium* was used to assess the mutagenicity of DMBA, benzo[a]pyrene (BAP), and 2-aminoanthracene (2AA) in the presence of liver microsomal enzymes from rats fed either a basal diet (0.02–0.15 mg selenium/kg diet or 0.001–0.0075 mg selenium/kg/day) or a sodium selenate-supplemented diet (basal diet plus 1–5 mg selenium/kg/diet or 0.05–0.25 mg selenium/kg/day) for 3–20 weeks. DMBA and 2AA were found to be less mutagenic in the presence of liver microsomal enzymes taken from rats fed the selenium-supplemented diets than in the presence of microsomal enzymes taken from rats fed the basal diet; BAP mutagenicity was not changed.

The genotoxicity of selenium monosulfide was assessed in *in vivo* micronucleus and chromosome aberration assays in rats (Moore et al. 1996b). Male Wistar rats (5/dose/timepoint) were administered 12.5, 25, or 50 mg/kg selenium monosulfide in corn oil. Negative control rats received corn oil by gavage and positive controls were injected intraperitoneally with 20 mg/kg cyclophosphamide. Animals were sacrificed 24, 36, or 48 hours after treatment and the femur marrow and spleen cells were examined. A small, but significant increase in micronucleated bone marrow cells was observed 24 hours after treatment with 50 mg/kg selenium monosulfide and 48 hours after treatment with 12.5 mg/kg selenium monosulfide. Selenium monosulfide was cytotoxic at the 50 mg/kg dose after 24 hours. No increase in micronucleus formation was observed in the spleen. No increase in chromosome aberrations was observed in the bone marrow or spleen.

3.4 TOXICOKINETICS

Occupational studies indicate that humans absorb elemental selenium dusts and other selenium compounds, but quantitative inhalation toxicokinetic studies in humans have not been done. Studies in dogs and rats indicate that following inhalation exposure, the rate and extent of absorption vary with the chemical form of selenium. Studies in humans and experimental animals indicate that, when ingested, several selenium compounds including selenite, selenate, and selenomethionine are readily absorbed, often to greater than 80% of the administered dose. Although a study of humans did not detect evidence of dermal absorption of selenomethionine, one study of mice indicates selenomethionine can be absorbed dermally. There is little or no information available on the absorption of selenium sulfides, but selenium disulfides are not believed to be absorbed through intact skin.

3. HEALTH EFFECTS

Selenium accumulates in many organ systems in the body; in general, the highest concentrations are found in the liver and kidney (Table 3-6). Selenium concentrations in tissues do not seem to be correlated with effects. Tissue concentrations were highest in pigs fed D,L-selenomethionine, while a similar dose of selenium (form not stated) given as *A. bisulcatus* was a more potent neurotoxin. Blood, hair, and nails also contain selenium, and selenium has been found in human milk (Table 3-7). In addition, selenium is subject to placental transfer.

As a component of glutathione peroxidase and the iodothyronine 5'-deiodinases, selenium is an essential micronutrient for humans. Its role in the deiodinase enzymes may be one reason that growing children require more selenium than adults. Selenium is also a component of the enzyme thioredoxin reductase, which catalyses the NADPH-dependent reduction of the redox protein thioredoxin. Other selenium-containing proteins of unknown functions, including selenoprotein P found in the plasma, have also been identified. Excess selenium administered as selenite and selenate can be metabolized to methylated compounds and excreted.

Selenium is primarily eliminated in the urine and feces in both humans and laboratory animals. The distribution of selenium between the two routes seems to vary with the level of exposure and time after exposure. The form of selenium excreted is dependent on the form of selenium that was ingested. In cases of acute exposure to toxic concentrations of selenium or selenium compounds, significant amounts of selenium can be eliminated in the breath, causing the characteristic "garlic breath."

A number of metabolism and other toxicokinetic studies of selenium are nutritional studies designed to answer a nutritional question, not a toxicological question. For example, the dose used may not be toxic, but may be meant to provide information on how a dose relevant to selenium deficiency or cancer chemoprevention might be handled in the body. Since the metabolism of selenium is a function of the dose ingested, these studies may be of limited toxicological relevance.

3.4.1 Absorption

3.4.1.1 Inhalation Exposure

Studies regarding the absorption of selenium in humans following inhalation exposure are limited to occupational studies. Glover (1970) examined urinary selenium levels of workers employed in a

3. HEALTH EFFECTS

Table 3-6. Selenium Concentrations in Human Tissues^{a,b}

Selenium concentration			Country	Reference
Mean	SD	Range		
Fetal tissues				
Liver (μg selenium/g)				
2.8	0.2		United States	Robkin et al. 1973 ^c
Blood (mg selenium/L)				
0.12	0.008		United States	Hadjimarkos et al. 1959
1.04	0.28		United States	Baglan et al. 1974 ^c
0.070	0.017		New Zealand	Thompson and Robinson 1980
0.061	0.014		Scandinavia	Korpela et al. 1984
Erythrocytes (mg selenium/L)				
0.39	0.08		United States	Rudolph and Wong 1978
0.149			Scandinavia	Haga and Lunde 1978
0.104	0.026		New Zealand	Thompson and Robinson 1980
Plasma (mg selenium/L)				
0.13	0.03		United States	Rudolph and Wong 1978
0.033	0.008		New Zealand	Thompson and Robinson 1980
Serum (mg selenium/L)				
0.052			Scandinavia	Haga and Lunde 1978
Adult/Infant tissues				
Adrenal gland (μg selenium/g)				
0.46	0.03		United States	Blotcky et al. 1979
0.21 (infant)			Canada	Dickson and Tomlinson 1967
0.36 (adult)				
Brain (μg selenium/g)				
0.11	0.021	0.114–0.171	Denmark	Larsen et al. 1979
0.16 (infant)			Germany	Oster et al. 1988c
0.27 (adult)			Canada	Dickson and Tomlinson 1967
		0.115–0.222	Japan	Ejima et al. 1996
Fat (μg selenium/g)				
0.09 (infant)			Canada	Dickson and Tomlinson 1967
0.12 (adult)				
Gonad (μg selenium/g)				
0.46 (infant)			Canada	Dickson and Tomlinson 1967
0.47 (adult)				

3. HEALTH EFFECTS

Table 3-6. Selenium Concentrations in Human Tissues^{a,b}

Selenium concentration			Country	Reference
Mean	SD	Range		
Heart (μg selenium/g)				
0.33	0.13		United States	Blotcky et al. 1979
0.170	0.032		Germany	Oster et al. 1988c
0.155	0.030 (LV)			
0.55 (infant)			Canada	Dickson and Tomlinson 1967
0.22 (adult)				
Intestine (μg selenium/g)				
0.31 (infant)			Canada	Dickson and Tomlinson 1967
0.22 (adult)				
Kidney (μg selenium/g)				
0.89	0.11		United State	Blotcky et al. 1979
0.771	0.169		Germany	Oster et al. 1988c
0.92 (infant)			Canada	Dickson and Tomlinson 1967
0.63 (adult)				
0.78	0.19	0.36–1.29	Sweden	Muramatsu and Parr 1988
Liver (μg selenium/g)				
0.62	0.04		United States	Blotcky et al. 1979
0.50	0.08	0.35–0.65	United States	Zeisler et al. 1984
1.73	0.24		United States	McConnell et al. 1975 ^c
		0.27–0.51	Denmark	Larsen et al. 1979
0.291	0.078		Germany	Oster et al. 1988c
0.995	0.308		Finland	Alfthan et al. 1991 ^c
0.45	0.11		Finland	Aaseth et al. 1990
0.06			Bulgaria	Damyanova 1983
0.33	0.12	0.082–0.64	Sweden	Muramatsu and Parr 1988
0.19	0.05	0.10–0.27	New Zealand	Casey et al. 1983
0.34 (infant)			Canada	Dickson and Tomlinson 1967
0.39 (adult)				
Lung (μg selenium/g)				
0.30	0.02		United States	Blotcky et al. 1979
0.132	0.033		Germany	Oster et al. 1988c
0.17 (infant)			Canada	Dickson and Tomlinson 1967
0.21 (adult)				
Pancreas (μg selenium/g)				
0.55	0.13		United States	Blotcky et al. 1979
0.63	0.07		United States	McConnell et al. 1975 ^c
0.05 (infant)			Canada	Dickson and Tomlinson 1967
0.13 (adult)				

3. HEALTH EFFECTS

Table 3-6. Selenium Concentrations in Human Tissues^{a,b}

Selenium concentration			Country	Reference
Mean	SD	Range		
Prostate (μg selenium/g)				
0.26	0.02		United States	Blotcky et al. 1979
0.150	0.035		Germany	Oster et al. 1988c
Skeletal muscle (μg selenium/g)				
0.40	0.20		United States	Blotcky et al. 1979
0.111	0.017		Germany	Oster et al. 1988c
0.31 (infant)			Canada	Dickson and Tomlinson 1967
0.40 (adult)				
		0.13–0.21	Denmark	Larsen et al. 1979
Skin (μg selenium/g)				
0.24	0.02		United States	Blotcky et al. 1979
Spleen (μg selenium/g)				
0.37	0.03		United States	Blotcky et al. 1979
0.226	0.044		Germany	Oster et al. 1988c
0.37 (infant)			Canada	Dickson and Tomlinson 1967
0.27 (adult)				
Stomach (μg selenium/g)				
0.19 (infant)			Canada	Dickson and Tomlinson 1967
0.17 (adult)				
Testis (μg selenium/g)				
0.28	0.03		United States	Blotcky et al. 1979
0.274	0.048		Germany	Oster et al. 1988c
Thyroid (μg selenium/g)				
1.02	0.20		United States	Blotcky et al. 1979
0.72	0.44	0.15–1.90	Finland	Aaseth et al. 1990
0.64 (infant)			Canada	Dickson and Tomlinson 1967
1.24 (adult)				

^aGeneral population measures unless otherwise noted

^bSelenium concentrations in adult blood and blood components, urine, hair, nails, milk, placenta, and semen are found in Table 3-7.

^cDry weight

LV = left ventricle; RV = right ventricle; SD = standard deviation

3. HEALTH EFFECTS

Table 3-7. Biomarkers: Selenium Concentrations in Human Tissues and Fluids^a

Selenium concentration				
Mean	SD	Range	Country	Reference
Whole blood (mg selenium/L)				
0.132	0.029	0.08–0.13	United States	Corden et al. 1989
0.206		0.10–0.30	United States	Allaway et al. 1968
0.109	0.015		United States	Dworkin et al. 1986
0.157		0.103–0.191	United States	Shamberger 1983
0.182	0.037		Canada	Dickson and Tomlinson 1967
0.095	0.009		China	Zhu 1981
0.095	0.091		China	Yang et al. 1983
0.164	0.032		Greece	Bratakos et al. 1990
0.108	0.006	0.076–0.140	Italy	Minoia et al. 1990
		0.079–0.103	Finland	Jaakkola et al. 1983
		0.080–0.089	Finland	Kumpusalo et al. 1990 ^b
		0.077–0.089	Finland	Kumpusalo et al. 1990 ^c
0.069	0.018		New Zealand	Thomson and Robinson 1980 ^d
0.059	0.012		New Zealand	Rea et al. 1979
0.092	0.001	0.06–0.013	Germany	Oster et al. 1988b
Erythrocyte (mg selenium/L)				
0.174		0.11–0.28	United States	Meyer and Verreault 1987
0.13	0.02		United States	Dworkin et al. 1986
0.52	0.05		United States	Rudolph and Wong 1978 ^d
0.131	0.002	0.060–0.210	Germany	Oster et al. 1988b
		0.057–0.087	New Zealand	Watkinson 1981
0.074	0.016		New Zealand	Rea et al. 1979
0.103	0.030		New Zealand	Thomson and Robinson 1980
Plasma (mg selenium/L)				
0.155		0.081–0.225	United States	Clark et al. 1984
0.095	0.016		United States	Dworkin et al. 1986
0.21	0.03		United States	Rudolph and Wong 1978 ^d
0.148			United States	Coates et al. 1988
0.081	0.016		Canada	Dickson and Tomlinson 1967
0.153	0.021		Japan	Hojo 1987
0.089	0.014		Netherlands	van't Veer et al. 1990
0.081	0.001	0.056–0.105	Italy	Minoia et al. 1990
0.118	0.027	0.064–0.173	Italy	Sesana et al. 1992
0.048	0.010		New Zealand	Rea et al. 1979
0.041	0.011		New Zealand	Thomson and Robinson 1980 ^d

3. HEALTH EFFECTS

Table 3-7. Biomarkers: Selenium Concentrations in Human Tissues and Fluids^a

Selenium concentration				
Mean	SD	Range	Country	Reference
Serum (mg selenium/L)				
0.136	0.002		United States	Willett et al. 1983
0.110	0.016		United States	Menkes et al. 1986
0.162	1.48		United States	Coates et al. 1988
0.07			United States	McConnell et al. 1975 ^e
0.125	0.047 ^g		United States	DHHS 1997
0.198	0.055	0.123–0.363	United States	Longnecker et al. 1991
0.143	0.016		Canada	Lalonde et al. 1982 ^f
0.081	0.001	0.033–0.121	Italy	Minoia et al. 1990
		0.087–0.093	Italy	Morisi et al. 1989
0.118	0.016	0.087–0.308	Finland	Luoma et al. 1992
0.055	0.001		Finland	Virtamo et al. 1987
0.073	0.015		South Africa	Heese et al. 1988 ^d
0.207		0.07–0.81	Venezuela	Brätter et al. 1991a
		0.229–0.621	Venezuela	Brätter and Negretti De Brätter 1996
Urine (mg selenium/L)				
0.034	0.024		England	Glover 1970
0.058	0.026	0.020–0.113	Japan	Hojo 1981a
0.026	0.012		China	Yang et al. 1983
0.024	0.002		Greece	Bratakos et al. 1990
0.022	0.002	0.002–0.031	Italy	Minoia et al. 1990
Hair (µg selenium/g)				
0.64	0.02		United States	Thimaya and Ganapathy 1982
0.359	0.004		China	Zhu 1981
0.36	0.17		China	Yang et al. 1983
0.42	0.88		Greece	Bratakos et al. 1990
0.42	0.10	0.21–0.63	Sweden	Muramatsu and Parr 1988 ^e
3.40	2.0	0.95–9.6 (female)	Japan	Imahori et al. 1979 ^e
3.70	2.3	0.06–14.2 (male)		
1.02	1.04	Maternal	England	Razagui and Haswell 1997
0.63	0.52	Neonatal		
0.54	0.34	Maternal	Spain	Bermejo Barrera et al. 2000
0.77	0.24	Child		
Nails (µg selenium/g)				
1.56	0.58	0.083–3.82	United States	Longnecker et al. 1991
0.82	0.174		United States	Hunter et al. 1990a
0.63	0.12		Netherlands	van't Veer et al. 1990
0.54	0.91		Greece	Bratakos et al. 1990
0.78		0.085–2.75	Netherlands	Van Noord et al. 1992

3. HEALTH EFFECTS

Table 3-7. Biomarkers: Selenium Concentrations in Human Tissues and Fluids^a

Selenium concentration				
Mean	SD	Range	Country	Reference
Milk (μg selenium/mL)				
		0.208–0.256	Africa	Funk et al. 1990 ^b
0.018	0.004	0.007–0.033	United States	Shrearer and Hadjimarkos 1975
0.021		0.013–0.053	United States	Hadjimarkos 1963
0.016	0.005			Smith et al. 1990
0.026			United States	Ellis et al. 1990
0.062	0.055	0.015–0.214	Chile	Cortez 1984
0.010	0.002	0.006–0.013	Finland	Kumpulainen 1983
0.011			Austria	Li et al. 1999
0.012			Germany	Michalke and Schramel 1998
		0.025–0.250	Venezuela	Brätter et al. 1991a
		0.043–0.112	Venezuela	Brätter and Negretti De Brätter 1996
Placenta (mg selenium/L)				
1.70	0.61		United States	Baglan et al. 1974 ^e
0.193	0.016		United States	Korpela et al. 1984
0.18	0.007		United States	Hadjimarkos et al. 1959
Semen (μg selenium/g)				
0.063	0.020	0.016–0.131	Singapore	Roy et al. 1990
1.80	0.11		Finland	Suistomaa et al. 1987 ^e

^aGeneral population measures unless otherwise noted

^bRange of mean concentration

^cRange of mean concentrations for multivitamin users

^dOnly women were sampled.

^eDry weight

^fOnly men were sampled.

^gStandard error of the mean

SD = standard deviation

3. HEALTH EFFECTS

selenium rectifier plant. Workers exposed to higher levels of unspecified inorganic selenium compounds in the air excreted higher levels of selenium in their urine than workers in other areas of the plant with lower concentrations of selenium in the air. Although the study indicates that selenium was absorbed from the lungs of the workers, the nonspecific exposure levels and lack of compound identification precluded an estimate of the extent and rate of absorption from the lungs. Significantly increased serum selenium levels were reported for workers at a rubber tire repair shop in Toluca City, Mexico compared with a group of unexposed individuals from the same city (Sánchez-Ocampo et al. 1996). The workers in this study were exposed to selenium (no levels reported) from vulcanized rubber, both as dust in the air and from handling the tires; thus, it is not possible to attribute absorption to a single route.

Studies using dogs and rats indicate that absorption of selenium following inhalation exposure is extensive, although the rate of absorption depends on the chemical form of selenium. In rats (Medinsky et al. 1981a) and dogs (Weissman et al. 1983), the absorption of selenium following inhalation exposure to selenious acid aerosol is approximately twice as rapid as the absorption of selenium following inhalation exposure to elemental selenium aerosol. However, Medinsky et al. (1981a) found that with either form after 4 days most of the selenium was absorbed following inhalation exposure and that the distribution of selenium in the body tissues was identical, suggesting that selenium entered the same body pool following pulmonary uptake (Medinsky et al. 1981a).

3.4.1.2 Oral Exposure

Selenium compounds are generally readily absorbed from the human gastrointestinal tract. The bioavailability of ingested selenium can be affected by the physical state of the compound (e.g., solid or solution), the chemical form of selenium (e.g., organic, inorganic), and the dosing regimen. However, in general, it appears that the degree of selenium absorption (i.e., percent of administered dose absorbed) in humans is independent of the exposure level, but that in some cases, absorption is greater when selenium deficiency exists.

In humans, absorption of sodium selenite or selenomethionine can exceed 80% for both small and relatively large doses (Griffiths et al. 1976; Thomson 1974; Thomson and Stewart 1974; Thomson et al. 1977). A total of 90–95% of a small amount of sodium selenite (0.010 mg selenium/person) administered in aqueous solution was absorbed (Thomson 1974). Absorption of a large dose (1.0 mg/person) of either

3. HEALTH EFFECTS

sodium selenite or selenomethionine was 90–95 and 97% of the administered dose, respectively (Thomson et al. 1977). These data indicate a lack of homeostatic control over the dose range tested. Martin et al. (1989a) found no clear evidence of increased gastrointestinal absorption of selenium as sodium selenite in aqueous solution by healthy male volunteers kept on a selenium-deficient diet. Griffiths et al. (1976) reported 96–97% absorption of a single dose of 0.002 mg selenium administered as selenomethionine in solution. Similarly, Thomson et al. (1977) reported 97% absorption of a single large dose of 1.0 mg selenium administered as selenomethionine in solution to one subject. The subjects in these studies were New Zealand women.

Other studies have indicated that humans might absorb selenomethionine more efficiently than sodium selenite (Moser-Veillon et al. 1992; Swanson et al. 1991). Young et al. (1982) studied human absorption of dietary selenium in young men in the United States. The men ate either ⁷⁵Se-labeled chicken alone (0.013 mg selenium/person) or the chicken plus supplemental labeled sodium selenite (0.071 mg selenium/person in a solution mixed with the meal). Eighty percent of the selenium in the chicken meat was absorbed, but less than 30% of the selenium administered as sodium selenite was absorbed. Similarly, Robinson et al. (1978) found that 75% of selenomethionine, but only 46% of selenite, was absorbed during a 10–11-week administration of solutions providing 0.0013–0.0023 mg selenium/kg/day to New Zealand women. It is not clear why the estimated absorption of sodium selenite varied between 46 and 30% in these trials.

Experimental animals also efficiently absorb selenium compounds from the gut independent of the level of selenium exposure. Several studies have reported absorption of 80–100% in rats given dietary selenium administered as sodium selenite, sodium selenate, selenomethionine, or selenocystine (Furchner et al. 1975; Thomson and Stewart 1973). Other animal species also readily absorb orally administered selenium compounds. Furchner et al. (1975) estimated that over 90% of an oral dose of selenious acid was absorbed in mice and dogs, although monkeys absorbed less of the administered dose (amount unspecified). Using an *in vivo* perfusion method in which selenite was added directly to the duodenal end of the small intestine, the absorption of selenite was linearly related to concentration (slope=0.0386) in the range of 1–200 μ M (Chen et al. 1993).

In one study of rats, absorption of selenite or selenomethionine into the blood stream following oral exposure occurred primarily in the duodenum and, to a lesser extent, in the jejunum and ileum (Whanger et al. 1976). Compared to the small intestine, little selenium was absorbed from the stomach (Whanger et al. 1976), and it was not determined whether absorption occurred in the large intestine. In an *in vitro*

3. HEALTH EFFECTS

study using everted intestinal sacs from hamsters, Spencer and Blau (1962) found that selenomethionine was transported against a concentration gradient with the same characteristics as methionine.

Selenomethionine was not found to be degraded during transport. This study suggests that in the intestines, methionine and selenomethionine share the same transport mechanism.

A comparison of absorption of selenium by selenium-depleted rats after oral administration of sodium selenate, selenomethionine, or methyl selenocysteine (from high-selenium broccoli) found that gross absorption of selenium from methyl selenocysteine was significantly lower (85%) than from sodium selenate or selenomethionine (91%); further, true selenium absorption adjusted for urinary excretion was significantly different for methyl selenocysteine, sodium selenate, and selenomethionine, with the lowest absorption for methyl selenocysteine and the highest for selenomethionine (Finley 1998). Absorption of selenium from selenomethionine was not significantly lower than from sodium selenate.

In vivo experiments with ligated rat intestines have shown that there is significantly higher absorption and transfer to the body of selenium as selenocystine or selenodiglutathione than selenium as selenite from ligated loops of ileum, but that absorption of the three forms of selenium in the jejunum was approximately similar (Vendeland et al. 1992). *In vitro* experiments with brush border membrane vesicles derived from rat intestines have shown dramatic differences in the uptake and binding of selenium depending on the form in which it is presented, with absorption of organic forms being much more efficient than absorption from selenite or selenate (Vendeland et al. 1992, 1994). Selenium from selenocystine or selenodiglutathione was absorbed 10 times more quickly than selenium from sodium selenite (Vendeland et al. 1992). Similarly, selenium was much more efficiently absorbed from selenomethionine than from selenite or selenate (Vendeland et al. 1994). Binding also varied between selenomethionine, selenite, and selenate, with selenite binding exceeding that of selenate by 37-fold and selenomethionine exceeding selenite by 14-fold (Vendeland et al. 1994). These studies indicate that absorption of selenium from the gastrointestinal tract of animals is pH-dependent and influenced by the presence of sulphhydryl-containing compounds, and that the increased absorption of selenium with sulphhydryl compounds is likely due to complex formation with these compounds.

3.4.1.3 Dermal Exposure

Dermal absorption was tested in eight women at a maximum dose of 0.0029 mg selenium/kg as selenomethionine (0.05% L-selenomethionine in a lotion). No detectable increase in serum selenium concentrations was observed, but because the concentrations tested were so low, absorption cannot be

3. HEALTH EFFECTS

ruled out (Burke et al. 1992a). Absorption of selenium disulfide was examined using a monthly 24-hour urine specimen in 16 persons who washed their hair weekly with a 1% selenium disulfide shampoo. No differences were found from control urinary selenium levels over the 1-year exposure period (Cummins and Kimura 1971). No absorption of selenium from selenium sulfide was seen in 15 persons who applied a 2.5% selenium sulfide suspension to their torsos and allowed it to remain on the body overnight (Kalivas 1993).

Mice were treated with a maximum of 0.02% selenium as selenomethionine by topical application of a lotion 3 times per week for 39 weeks to the shaved back and ears (size of area not specified). The applied dose was 0.29 mg/kg/day. Controls received the lotion without selenium. Dermal effects were not observed in the selenomethionine-treated mice. However, treated animals had significantly higher concentrations of selenium than the controls in the liver and ventral skin away from the application site (Burke et al. 1992b). These data suggest that mice can absorb topically applied selenomethionine, but since the areas were not occluded, some oral absorption during grooming is also possible.

3.4.2 Distribution

Most studies report similar distribution patterns for both organic and inorganic selenium compounds tested. In plasma, selenium mainly distributes into three plasma proteins, namely selenoprotein P, glutathione peroxidase, and albumin (Ducros et al. 2000). Approximately 3% of total plasma selenium is bound to lipoproteins, mainly to the LDL fraction, and the selenium may be incorporated as selenomethionine in place of methionine during protein synthesis and/or bound to cysteine residues by selenium-sulfur bonds. Selenoprotein P is an extracellular protein in the plasma. It is suggested that selenoprotein P is involved in the transport of selenium and as an antioxidant, but its biochemical function has not yet been established (Burk and Hill 2000; Hill and Burk 1989; Yang et al. 1989b).

Normal levels of selenium found in various human tissues are shown in Table 3-6. Selenium concentrations in human fluids and tissues that are easily collected (e.g., placenta) are provided in Section 3.8.1, Biomarkers Used to Identify or Quantify Exposure to Selenium. Selenium from sodium selenite and sodium selenate is found at the highest concentrations in the liver and kidney of humans and other animals following oral administration or intravenous or subcutaneous injection (Cavalieri et al. 1966; Heinrich and Kelsey 1955; Jereb et al. 1975; Thomson and Stewart 1973). Similarly, monkeys receiving high doses of L-selenomethionine orally for up to 30 days accumulated the highest

3. HEALTH EFFECTS

concentrations of selenium in the liver and kidneys (Willhite et al. 1992). Selenium from selenomethionine tends to be retained in tissues at higher concentrations (3–10-fold greater) and for longer periods of time than inorganic selenium compounds. The increased selenium tissue concentrations are not due to the slightly greater absorbance of selenomethionine (Butler et al. 1990; Grønbaek and Thorlacius-Ussing 1992; Ip and Hayes 1989; Salbe and Levander 1990b), but rather to the slower elimination as a consequence of its incorporation into body proteins (Stadtman 1983, 1987, 1990).

3.4.2.1 Inhalation Exposure

No studies were located regarding the distribution of selenium in humans after inhalation of elemental selenium or selenium compounds.

Weissman et al. (1983) reported that selenium concentrated in the liver, kidney, spleen, and lungs of dogs following inhalation exposure to selenious acid or elemental selenium aerosols.

3.4.2.2 Oral Exposure

A study of 100 paired samples of maternal and neonate hair found that the concentration in neonatal hair (0.63 ± 0.52 $\mu\text{g/g}$) was lower than in maternal hair (1.02 ± 1.04 $\mu\text{g/g}$), but the results were not analyzed statistically (Razagui and Haswell 1997). Levels of selenium in 30 paired samples of the hair of a mother and her child found no correlation between the selenium concentration of the hair of the mother and her child (Bermejo Barrera et al. 2000). The average level of selenium in the children's hair (0.77 ± 0.24 $\mu\text{g/g}$) was higher than that of their mothers (0.54 ± 0.34 $\mu\text{g/g}$). The higher concentration of selenium in the children's hair could represent increased absorption or retention, but no information was provided in the study as to the age of the children or to possible differences in dietary intake of selenium between mother and child.

A study in rats found that young (weanling) animals accumulated more selenium in their tissues than adults (Salbe and Levander 1989). Selenium-deficient rats were fed diets supplemented with the same amounts of selenium, as sodium selenate or L-selenomethionine, for 4 weeks. Hair and nail selenium levels in adults were 10–20% and ~50% lower, respectively, than the amounts found in weanlings. Skeletal muscle and red blood cell selenium levels were ~50 and ~35% lower, respectively, in adults than weanlings, whereas levels in the liver were generally similar between the two growth phases.

3. HEALTH EFFECTS

Selenomethionine caused greater deposition of selenium in the tissues than sodium selenate in both adults and weanlings, although the percent increase was similar for the two compounds in both growth phases. In rats and dogs, the selenium arising from sodium selenite administered in drinking water or in the diet is widely distributed in the body, although concentrated primarily in the liver and kidney (Furchner et al. 1975; Sohn et al. 1991; Thomson and Stewart 1973).

In most studies, selenium from selenomethionine accumulates in tissues to a greater extent than equal administered doses of selenium from selenite or selenate. Behne et al. (1991) reported higher liver and muscle selenium concentrations in rats receiving selenium orally as selenomethionine for 3 or 6 weeks than as selenite for the same length of time. Ip and Hayes (1989) reported similar results for blood, liver, kidney, and skeletal muscle. Salbe and Levander (1990b) compared distribution of dietary selenomethionine and selenate in rats and found higher selenium concentrations in plasma, erythrocytes, liver, muscle, hair, and nails in animals receiving selenomethionine. (Hair and nails have been used to gauge long-term human selenium exposure and were, therefore, included in this study.) Monkeys receiving selenomethionine in drinking water for 11 months had selenium concentrations in plasma, erythrocytes, liver, muscle, and hair that were 3–10-fold greater than monkeys receiving selenite (Butler et al. 1990). The higher levels of selenium found after selenomethionine compared to selenite treatment are likely a result of a greater retention of selenium from selenomethionine, rather than a difference in absorption. Butler et al. (1990) indicate that dietary ascorbic acid can reduce selenite absorption, but not selenomethionine absorption. Therefore, the differential effect of ascorbic acid on selenium absorption may have contributed to the difference in selenium content of tissues observed in monkeys treated with selenite, compared to monkeys treated with selenomethionine. Studies of rats indicate that the central nervous system also concentrates more selenium when administered as selenomethionine than when administered as inorganic selenium compounds (Grønbaek and Thorlacius-Ussing 1989, 1992; Zi-Jian Jie 1992).

A comparison of distribution of selenium in selenium-depleted rats after oral administration of sodium selenite, sodium selenate, selenomethionine, or methyl selenocysteine (from high-selenium broccoli) revealed that the rate of restoration of selenium in the liver and muscle was significantly slower for methyl selenocysteine than other forms of selenium (Finley 1998). The rate of repletion in muscle was significantly faster for selenomethionine than other groups, but kidney and plasma showed no significant difference in the rate of repletion for any form of selenium. The rate of repletion of glutathione peroxidase activity in the tissues was similar to the rate of repletion of the tissue itself and was slowest when methyl selenocysteine was the administered form.

3. HEALTH EFFECTS

Another study of distribution of selenium in selenium-deficient rats fed either sodium selenite or selenomethionine found that the concentration of selenium in blood and hair increased with administered dose, but was higher for selenium administered as selenomethionine (Shiobara et al. 1998).

A study of dietary supplementation of female pigs with 0.1 or 0.3 ppm selenium from a selenium-enriched yeast or from sodium selenite (doses not given) from 60 days before breeding until weaning found that the concentration of selenium in milk, dam, and offspring tissues increased with the dose of selenium administered and was higher when the source of selenium was the selenium-enriched yeast (Mahan and Kim 1996).

A study using pigs indicates that tissue levels of selenium do not correlate with effects. Tissue concentrations of selenium were higher in pigs fed 1.25 mg selenium/kg/day as D,L-selenomethionine than in pigs fed the same dose of selenium as *A. bisulcatus* or selenate, although neurological effects were more severe and occurred after fewer days of treatment with *A. bisulcatus* (Panter et al. 1996). The form of selenium in *A. bisulcatus* is unknown, although Panter et al. (1996) indicate that it is nonprotein.

In poultry, selenium is concentrated in the pancreas to a greater extent following oral administration of selenomethionine than following oral administration of sodium selenite (Cantor et al. 1975). The differential ability of the two compounds to concentrate in the pancreas of birds may explain why selenium administered as selenomethionine is more effective than the same dose of selenium administered as sodium selenite in preventing pancreatic fibrosis in chicks, a condition indicative of selenium deficiency (Cantor et al. 1975).

The distribution profiles of single oral or intravenous doses of selenium (2 mg selenium/kg as sodium selenite) administered to Wistar rats were dependent on the route of administration (Kaneko et al. 1999). Selenium concentration was highest in the kidney or liver, followed by the heart, lung, or spleen; then plasma and the brain. Oral administration produced lower doses of selenium than injection in all organs except the kidney where levels produced by the two routes were comparable (this may reflect the importance of urine as a route of excretion).

Following oral exposure, selenium is found in human milk (Brätter and Negretti De Brätter 1996; Brätter et al. 1991b; Li et al. 1999; Michalke and Schramel 1998; Moser-Veillon et al. 1992; Rodríguez Rodríguez et al. 1999; Viitak et al. 1995; Yang 1989b). Selenium is also found in the milk of mice, rats,

3. HEALTH EFFECTS

dogs, pigs, cows, and monkeys (Abdelrahman and Kincaid 1995; Archimbaud et al. 1992; Bañuelos and Mayland 2000; Chhabra and Rao 1994; Hawkes et al. 1994; Mahan and Kim 1996; Parizek et al. 1971a). This supplies offspring with selenium during the time period in which they are fed exclusively on milk (about 6 months for humans). Transplacental transfer of selenium has been demonstrated in humans, rats, hamsters, dogs, pigs, and monkeys (Archimbaud et al. 1992; Choy et al. 1993; Hawkes et al. 1994; Jandial et al. 1976; Mahan and Kim 1996; Parizek et al. 1971a; Willhite et al. 1990).

3.4.2.3 Dermal Exposure

Although unable to detect increased selenium in human females exposed to selenomethionine dermally, Burke and coworkers found elevated liver and skin selenium concentrations in mice treated with a topical lotion containing selenomethionine applied to the shaved back and ears (size of area not specified), although since the areas were not occluded, some oral absorption during grooming is also possible (Burke et al. 1992a, 1992b). In rats, between 9 and 27% of dermally applied selenious acid was absorbed, as measured in ⁷⁵Se radioisotope studies (Medinsky et al. 1981b).

3.4.2.4 Other Routes of Exposure

In humans, selenium has been found to be widely distributed to organs and tissues following injection of sodium selenite, sodium selenate, and selenomethionine, with the highest concentrations generally found in the liver and kidneys (Ben-Porath and Kaplan 1969; Cavalieri et al. 1966; Jereb et al. 1975; Lathrop et al. 1972). In studies involving injection of radiolabelled selenium, the pancreas accumulated high concentrations of radiolabelled selenium immediately following injection, but within hours, the selenium rapidly disappeared from this organ (Lathrop et al. 1972). Using an *in vitro*, dually perfused, human term placenta, selenite has also been shown to cross the human placenta (Eisenmann and Miller 1994). Further, following intravenous injection, ⁷⁵Se from selenomethionine was found to cross the near-term human placenta (Jandial et al. 1976).

There is a rapid decline in serum selenium levels 1 hour after intravenous administration of sodium selenite or sodium selenate to humans (Burk 1974; Nelp and Blumberg 1965). Burk (1974) found that 50% of the plasma selenium was protein-bound within the first 2 hours after administration; 85% was bound within 4–6 hours after administration; and 95% was bound after 24 hours. Circulating alpha-2 globulins have been reported to have the greatest affinity for selenium (Hirooka and Galambos 1966a).

3. HEALTH EFFECTS

Burk (1974) found that lipoproteins, primarily the very low density lipoprotein (VLDL) and the low-density lipoprotein (LDL) fractions, were also involved in selenium binding.

In vitro studies of human plasma and whole blood incubated with sodium selenite have indicated that selenite is accumulated in erythrocytes by an active transport mechanism (Lee et al. 1969). Several studies indicate that the selenite is chemically altered in the erythrocyte and then transported back into the plasma, where the selenium metabolite binds to plasma proteins (Burk 1974; Hirooka and Galambos 1966a; Lee et al. 1969).

A high degree of protein binding of selenium in the plasma has also been demonstrated in experimental animals. Sandholm (1973) found that selenite administered intravenously to mice can be metabolically altered by erythrocytes to a form that binds to plasma proteins. In mice, rats, and dogs, selenite initially binds to albumin. Later, selenite can be found bound to alpha and gamma globulins in rats and to alpha-2 and beta-1 globulins in dogs (Imbach and Sternberg 1967; Sternberg and Imbach 1967).

3.4.3 Metabolism

The metabolic fate of selenium, an essential element, is outlined in Figure 3-4. In summary, inorganic selenium is reduced stepwise to the assumed key intermediate hydrogen selenide, and it (or a closely related species) is either incorporated into selenoproteins after being transformed to selenophosphate and selenocysteinyl tRNA according to the UGA codon encoding selenocysteinyl residue, or excreted into urine after being transformed into methylated metabolites of selenide (Lobinski et al. 2000).

Consequently, selenium is mainly present in the mammalian body in forms of covalent carbon-selenium bonds, particularly selenoprotein P (the principal selenoprotein in plasma), selenoenzymes such as glutathione peroxidases (enzymes that catalyze the reduction of peroxidases and thereby protect cells from oxidative damage), type 1-iodothyronine deiodinase (which catalyzes the deiodination of thyroxine to triiodothyronine), and thioredoxin reductase (which may trigger cell signaling in response to oxidative stress) (Holmgren and Kumar 1989; Lobinski et al. 2000). Additional information regarding the metabolism of selenium is discussed below.

3. HEALTH EFFECTS

Figure 3-4. Metabolic Pathways for Selenium*

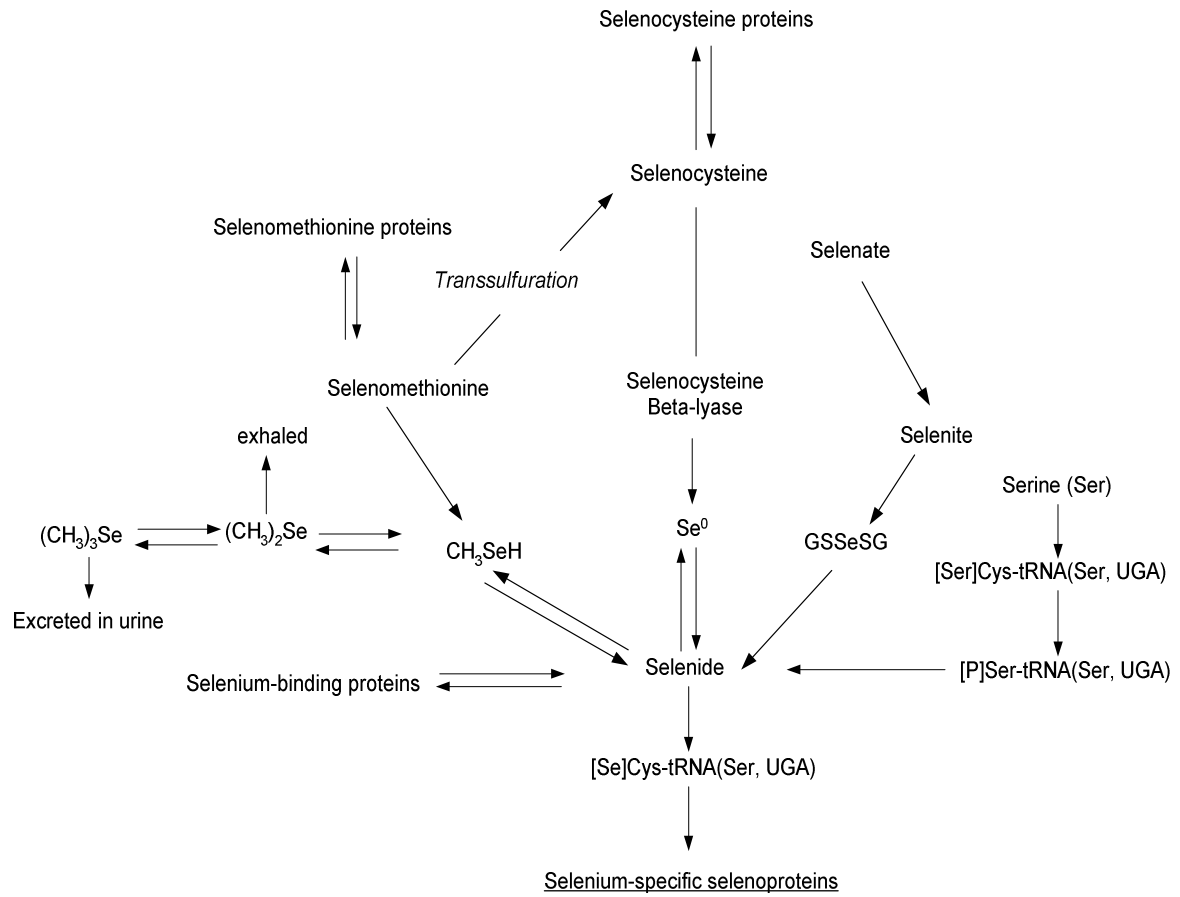

*Adapted from Sundde, 1990

3. HEALTH EFFECTS

Four classes of selenoproteins have been defined (Sunde 1990): selenium-specific proteins, proteins incorporating selenocysteine at cysteine codons, proteins incorporating selenomethionine at methionine position in those proteins, and proteins that bind selenide nonspecifically. The selenium-specific proteins, which include the enzymes glutathione peroxidase, thyroxine reductase, and iodothyronine 5'-deiodinase, constitute the most physiologically important class of selenoproteins. These proteins contain selenocysteine that is incorporated cotranslationally using selenide and serine as the precursors. This process is specified by a uracil-guanine-adenine (UGA) codon, which usually functions as a stop codon. A stem-loop structure in the 3' untranslated region is required for UGA to specify selenocysteine (Berry et al. 1991). This cotranslational process is the only known pathway for the production of selenocysteine in humans. In contrast to selenocysteine, selenomethionine cannot be biosynthesized by human tissues (Levander 1986).

The second and third classes of selenoproteins form in a similar manner: selenomethionine bound to the transfer ribonucleic acid (tRNA) for methionine competes with methionine bound to the tRNA for methionine at methionine codons, and selenocysteine bound to the tRNA for cysteine competes with cysteine bound to the tRNA for cysteine at cysteine codons (Sunde 1990). The amount of selenoamino acids incorporated into protein is dependent on the ratio of the selenoamino acid and the amino acid bound to the amino acid tRNA.

The last class of selenoproteins contains the selenium binding proteins. This is an operational class defined by Sunde (1990) as "selenoproteins with selenium bound tightly enough so that the selenium remains attached during standard protein purification procedures that produce discrete selenium labeled species." This class contains selenoproteins that have not been fully characterized.

As indicated in Figure 3-4, selenide, which can nonspecifically bind to proteins, is a central selenium species in the pathways leading to the formation and degradation of selenium proteins. Selenide is also formed from selenite by reduction via glutathione following uptake in red blood cells. This reaction occurs in rat (Gasiewicz and Smith 1978) and human (Lee et al. 1969) red blood cells, as well as in human plasma containing added glutathione (Mas and Sarker 1989). Selenide is then transported to the plasma, bound selectively to albumin and transferred to the liver, and methylated for excretion in the urine, or incorporated into proteins after being transformed into selenium-phosphate and selenocysteinyl

3. HEALTH EFFECTS

tRNA according to the UGA codon encoding selenocysteinyl residue (Ganther and Lawrence 1997). Unlike selenite, selenate appears to be either taken up directly by the liver or excreted in urine by rats (Suzuki and Ogra 2002).

Selenocysteine can also be metabolized to selenide. This reaction requires a specific enzyme, selenocysteine β -lyase, which catalyzes the decomposition of selenocysteine to alanine and hydrogen selenide. The enzyme requires pyridoxal 5-phosphate as a cofactor. In humans, the highest levels of selenocysteine β -lyase activity are found in the liver, followed by the kidney, heart, adrenal gland, and muscle (Daher and Van Lente 1992). In mice orally exposed to selenocysteine, an intermediate metabolite selenocysteine-glutathione selenyl sulfide is formed in the small intestine and transported to the liver via the blood plasma (Hasegawa et al. 1995, 1996b). This compound can be nonenzymatically reduced by excess glutathione or enzymatically reduced by glutathione reductase in liver cytosol extracts to reform selenocysteine, which can be further metabolized.

When not immediately metabolized, selenomethionine can be incorporated into tissues such as skeletal muscle, liver, pancreas, stomach, gastrointestinal mucosa, and erythrocytes (Schrauzer 2000). Selenomethionine metabolism to selenide and the incorporation into selenium-specific proteins may occur by two pathways: metabolism to methane selenol and selenide or via selenocysteine. Evidence that the incorporation of selenium from selenomethionine into protein is by the transsulfuration pathway (methionine to cysteine) comes from studies of selenomethionine metabolism in lymphoblast cell lines deficient in cystathionine lyase and cystathionine synthetase, enzymes of the transsulfuration pathway (Beilstein and Whanger 1992). Deficiency in these enzymes greatly reduces the incorporation of selenomethionine into glutathione peroxidase.

Similar to metals, elemental selenium, a non-metal, is transformed into methylated metabolites prior to being excreted into the urine and/or exhaled. Methylation is a detoxification pathway for selenium, and the extent of methylation is dose-dependent (Kobayashi et al. 2002). Monomethylated selenium is excreted as the major form in urine at deficient, normal, and low-toxic levels of selenium. When monomethylated selenium reaches a plateau in the urine (i.e., in the toxic dose range of selenium), trimethylated selenium in the urine and dimethylated selenium in the expired air increase. The major monomethylated form of selenium has been thought to be methylselenol, but Kobayashi et al. (2002) identified it as a selenosugar (1 β -methylselenol-*N*-acetyl-D-galactosamine).

3. HEALTH EFFECTS

Humans accidentally exposed to high levels of selenium have been reported to have a noticeable garlic odor of the breath, probably as a result of excretion of dimethyl selenide in expired air (Bopp et al. 1982; Wilbur 1980). Garlic odor of the breath has been noted in humans following ingestion of toxic levels of sodium selenate (Civil and McDonald 1978) and following inhalation of elemental selenium dust or selenium dioxide (Glover 1970).

In human populations with sufficient levels of selenium, dietary selenium is apparently partitioned into a selenite-exchangeable storage pool and a selenite-nonexchangeable storage pool. The selenite-exchangeable pool shows saturation kinetics. After this pool is filled, dietary selenium as selenomethionine may be the primary determinant of selenium bioavailability and serum selenium concentrations (Meltzer et al. 1990, 1992). There is experimental support for the concept that selenium metabolism can be divided into non-specific and specific components (Burk et al. 2001).

Selenomethionine is the non-specific component as it appears to be incorporated into plasma proteins, presumably as selenomethionine, in proportion to its presence in the methionine pool. There is no indication that selenocysteine and inorganic selenium (selenate) were incorporated non-specifically into plasma protein, suggesting that these forms are metabolized by specific selenium metabolic processes. For example, selenocysteine seems to incorporate selenium into selenoproteins, but not into other proteins in place of cysteine (Burk et al. 2001). Selenate was either taken up directly by the liver or excreted in the urine, and selenite was taken up by red blood cells, reduced to selenide by glutathione, and then transported to the plasma and transferred to the liver (Suzuki and Ogra 2002). Data from both humans and Rhesus monkeys indicate that the selenium concentration in glutathione peroxidase is independent of the form of selenium administered and suggest a metabolic saturation at average intake rates (Butler et al. 1990; Meltzer et al. 1990).

In macaques that were orally administered doses of 0.025–0.3 mg selenium/kg as L-selenomethionine for up to 30 days, both erythrocyte selenium and glutathione peroxidase-specific activity showed a delay before increasing in a dose-related manner (Hawkes et al. 1992). At 0.15 and 0.3 mg selenium/kg, glutathione peroxidase-specific activity in erythrocytes continued to increase for 15 days after cessation of treatment and remained elevated through the end of the study (40 days after the end of treatment). The investigators attributed this effect to an initial deposition of selenium into a nonspecific pool (such as substitution for methionine in serum proteins), followed by slow release into the erythrocyte. Wistar rats also show incorporation of selenomethionine into proteins (Behne et al. 1991).

3. HEALTH EFFECTS

In rats, dimethyl selenide has been identified as the primary respiratory metabolite following injection of sodium selenite or sodium selenate (Hirooka and Galambos 1966b) and appears to be produced in the liver (Nakamuro et al. 1977). In mice, dimethyl selenide and dimethyldiselenide have been detected in expired air following the addition of unspecified amounts of sodium selenite, D,L-selenomethionine, or D,L-selenocystine to their drinking water (Jiang et al. 1983). A third unidentified volatile selenium compound was detected in expired air of the mice following D,L-selenomethionine injection (Jiang et al. 1983).

In rats, the trimethylselenonium ion has been identified as the predominant urinary metabolite following intraperitoneal administration of sodium selenite (Byard and Baumann 1967), sodium selenate, selenomethionine, selenocystine, or methylselenocysteine, or following ingestion of seleniferous wheat (Palmer et al. 1970). A total of 30.8% of the urinary selenium was in the form of trimethylselenonium after administration of 15 ppm selenium in wheat. Another major selenium metabolite that appeared in the urine more slowly than the trimethylselenonium ion was identified chromatographically, but the chemical structure of that metabolite was not defined (Palmer et al. 1970).

Similarly, the trimethylselenonium ion was the major urinary metabolite of selenium excreted by rats after intraperitoneal injection of either methylselenocysteine (4 mg/kg) or selenocysteine (3 mg/kg) (Palmer et al. 1970). The amounts of trimethylselenonium ion excreted were 50.6 and 49.7% of the total urinary metabolites after methylselenocysteine and selenocysteine administration, respectively. In both cases, urinary metabolism accounted for only 10–15% of the administered dose. As selenium was not measured in feces or expired air, recovery of the dose was incomplete. In a review of the metabolic pathways resulting in the production of dimethyl selenide from selenite in rodents, Ganther (1979) indicated that reduction of selenite or selenate to dimethyl selenide requires glutathione and the methylating agent *S*-adenosylmethionine. NADPH, coenzyme A, ATP, and magnesium (II) salts are also required to provide optimal conditions for this reaction (Ganther 1979). Ganther (1971) and Hsieh and Ganther (1975) found that selenite initially reacts nonenzymatically with glutathione to form a selenotrisulfide derivative. The selenotrisulfide is then reduced nonenzymatically in the presence of glutathione or enzymatically by glutathione reductase in the presence of NADPH to a selenopersulfide (GSSeH). The selenopersulfide is unstable and decomposes to glutathione and selenium or is enzymatically reduced by glutathione reductase in the presence of NADPH to hydrogen selenide (Ganther 1971; Hsieh and Ganther 1975). Hydrogen selenide can be methylated by *S*-adenosylmethionine in the presence of selenium methyltransferase to form dimethyl selenide (Figure 3-5).

3. HEALTH EFFECTS

Figure 3-5. Proposed Pathway for Formation of Dimethyl Selenide from Selenite in Animals*

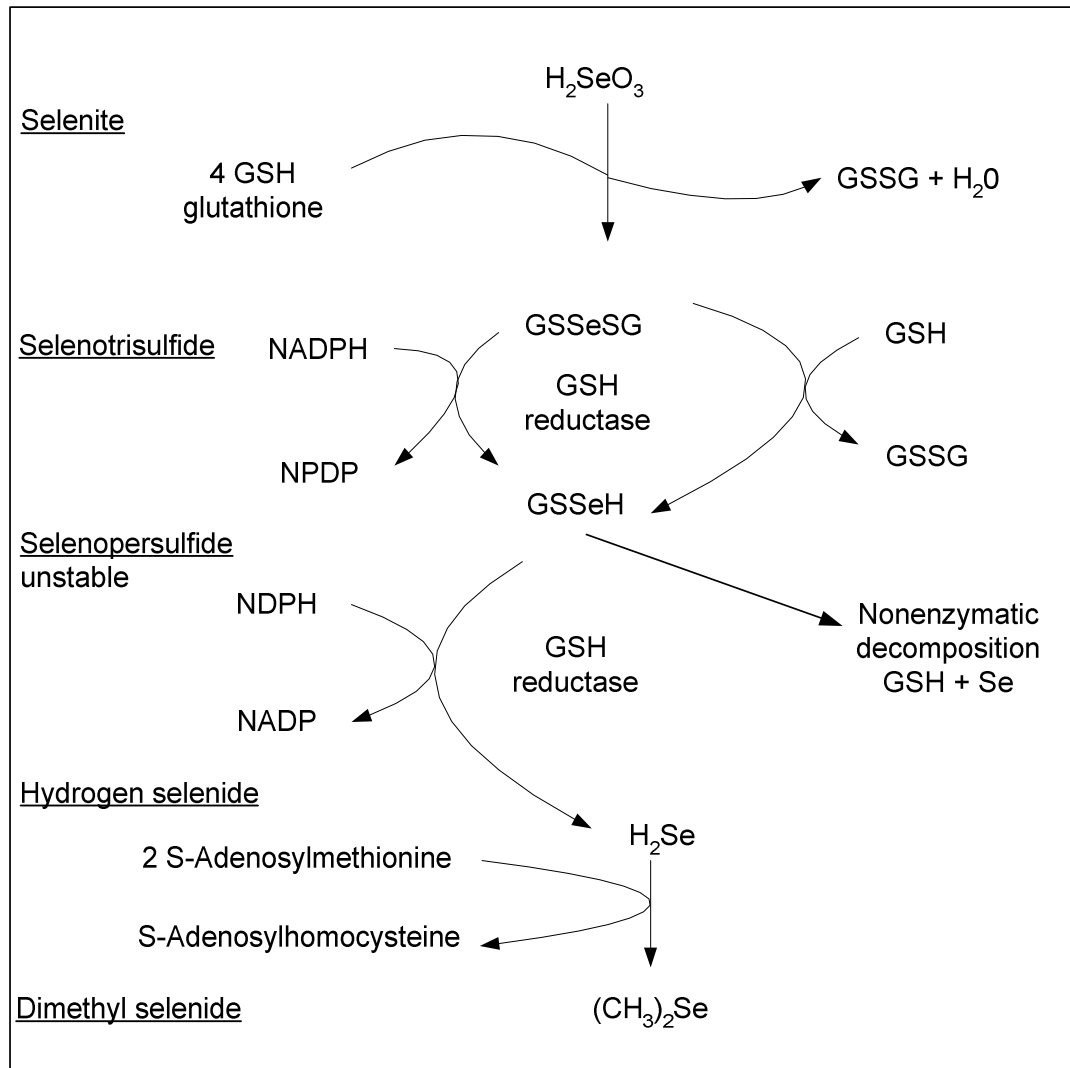

*Adapted from Hsieh and Ganther 1975 and Ganther 1971

3. HEALTH EFFECTS

Selenate apparently is not converted to dimethyl selenide as readily as is selenite. Studies of selenate metabolism are limited in mammals, but studies using bacteria indicate that selenate must be activated prior to conversion to selenite (Bopp et al. 1982). Dilworth and Bandurski (1977) demonstrated that in the presence of ATP, magnesium (II) salts, and ATP-sulfurylase, yeast could convert selenate to eventually yield selenite (Figure 3-6). Data regarding the metabolism of selenium sulfide after administration to humans or other animals were not located in the literature.

3.4.4 Elimination and Excretion

Excretion of selenium can occur in the urine, feces, and expired air (Griffiths et al. 1976; Hawkes et al. 1992, 1994; Lathrop et al. 1972; McConnell and Roth 1966; Thomson and Stewart 1974). Sweat is a minor pathway of selenium excretion in humans (Levander et al. 1987). Moreover, the initial rate of excretion appears to be dose dependent (Lathrop et al. 1972; McConnell and Roth 1966; Thomson and Stewart 1974). Some researchers have found that urinary excretion and fecal excretion of selenium are similar, with each route contributing approximately 50% of the total output (Stewart et al. 1978). However, the proportion excreted via each route seems dependent on several factors, including the level of exposure, the time since exposure, and the level of exercise. Lactating women and subjects depleted of selenium have decreased excretion of selenium in the urine and feces (Martin et al. 1989a, 1989b; Moser-Veillon et al. 1992). At high selenium exposure levels, excretion of selenium in expired air becomes more significant (McConnell and Roth 1966; Olson et al. 1963).

3.4.4.1 Inhalation Exposure

Following acute inhalation exposures to selenium compounds, humans excrete some of the absorbed dose in the expired air (Glover 1970), but no studies were located that actually quantified the rate of excretion or identified the selenium compounds in the expired air of humans.

3.4.4.2 Oral Exposure

Several human studies have indicated that the rate of urinary excretion is most rapid in the first 24 hours following oral administration or intravenous injection of sodium selenite (Kuikka and Nordman 1978;

3. HEALTH EFFECTS

Figure 3-6. Activation and Reduction of Selenate to Selenite in Yeast *Saccharomyces cerevisiae**

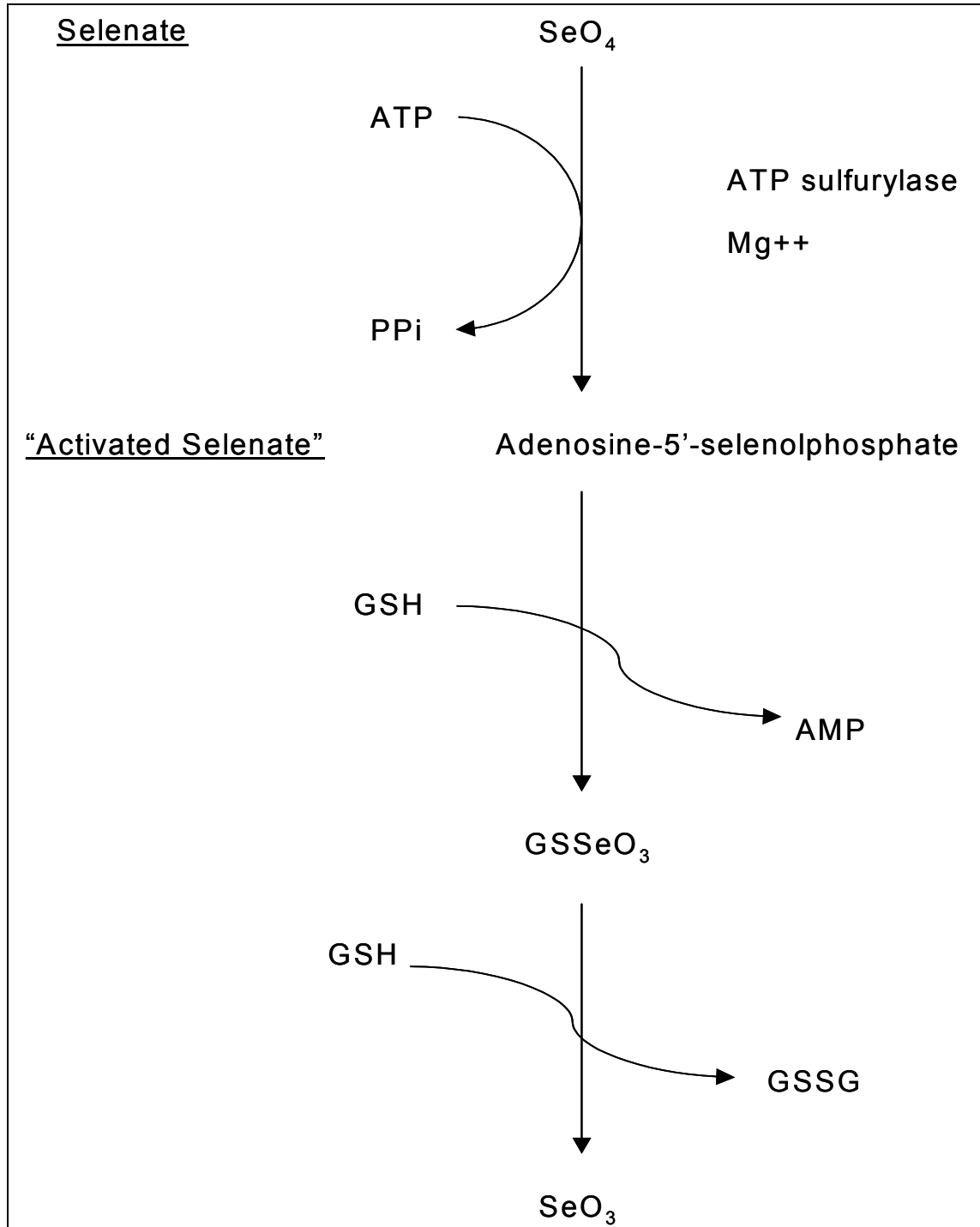

*Adapted from Dilworth and Bandurski 1977

3. HEALTH EFFECTS

Thomson and Stewart 1974). Thomson and Stewart (1974) found that <6% of a trace dose (0.01 mg selenium) of orally administered sodium selenite was excreted in the urine within 24 hours of administration, whereas 64–73% of a 1-mg dose of selenium was excreted in the first 24 hours (Thomson 1974). Thomson et al. (1977) also found that a lower proportion of the selenium from an oral dose of 0.1 mg selenium administered as selenomethionine was excreted in the 24-hour urine than from a larger dose (1.0 mg selenium). Similarly, low selenium New Zealand residents excreted proportionally less selenium in their urine than North Americans of higher selenium status (Robinson et al. 1985), and there is limited evidence of such adaptation to selenium intake in some animal studies (Jaffe and Mondragon 1969, 1975; WHO 1987). Thus, when higher amounts of selenium are administered, a higher proportion of the selenium is excreted in the urine during the first 24 hours following exposure.

Decreasing urinary or fecal excretion appears to be the homeostatic mechanism by which the body retains greater amounts of selenium. Martin et al. (1989a) observed greater retention of selenium by individuals maintained on a selenium-deficient diet. This increase in retention was correlated with a decrease in fecal elimination. Similarly, the increased retention of selenium from selenomethionine compared to selenite was correlated with decreased elimination (Swanson et al. 1991). Lactating women have a greater retention of selenium from selenomethionine compared to selenite and a decreased urinary elimination (Moser-Veillon et al. 1992). Muscle activity seems to influence urinary excretion of selenium as demonstrated by the doubling of selenium concentration in the urine of women following vigorous exercise (Oster and Prellwitz 1990).

Less information is available regarding the elimination of selenium in the feces of humans than in the urine of humans. However, levels of fecal excretion of selenium have been reported to be similar to levels of urinary selenium excretion when dietary levels of selenium are not excessive (Patterson et al. 1989). Over a 14-day period, Stewart et al. (1978) found urinary elimination of selenium to average 0.013 mg selenium/day and fecal elimination of selenium to average 0.011 mg selenium/day in four New Zealand women exposed to 0.024 mg selenium/day in their normal diets. Balance data on 27 healthy U.S. adults (12 men and 15 women) similarly indicated an approximately even split between urine and fecal selenium excretion (Levander and Morris 1985). Determination of selenium balance at four time points (spring, summer, fall, and winter) showed respective average levels of selenium in the urine and feces of 48 ± 2 and 34 ± 1 $\mu\text{g}/\text{day}$ in the men, and 39 ± 1 and 23 ± 1 $\mu\text{g}/\text{day}$ in the women. Plasma selenium levels remained essentially constant during the year and were similar in the men and women, averaging 136 ± 4 and 133 ± 4 ng/L, respectively. Although the U.S. men consumed more selenium in the diet than the

3. HEALTH EFFECTS

women, their selenium balance (8 ± 4) was less positive than the women (12 ± 3) because they tended to excrete more in the feces (Levander and Morris 1985). It has been suggested that some of the selenium content in feces can be attributed to biliary excretion (Levander and Baumann 1966a, 1966b).

In humans, whole body retention studies following oral administration of sodium selenite have indicated that selenium elimination is triphasic (Thomson and Stewart 1974). During the initial phase, which lasted about 1 week, elimination of selenium was rapid, with a half-life of approximately 1 day (Thomson and Stewart 1974). In the second phase, which also lasted approximately 1 week, selenium elimination was slower, with a half-life of 8–9 days. In the third phase, selenium elimination was much slower, with a half-life estimated to be 115–116 days. The first two elimination phases correspond to the fecal elimination of nonabsorbed selenium and the urinary excretion of absorbed but unutilized selenium (Thomson and Stewart 1974). Selenomethionine elimination is also triphasic; however, its terminal half-life is longer than that of sodium selenite. The average half-lives of selenomethionine for the three phases were measured to be approximately 0.4–2, 5–19, and 207–290 days, respectively (Griffiths et al. 1976). An examination of elimination data from 44 pigs exposed to excess selenium as sodium selenite in feed was found to fit a one-compartment model of selenium elimination (Davidson-York et al. 1999). Serum selenium levels were monitored over a period of 46 days beginning 1–14 days after termination of exposure to the feed containing excess selenium. Data were not adequate to depict the initial distribution phase, but a geometric mean elimination half-life of 12 days was calculated. It is likely that the period of elimination included in this study corresponds to the second phase described by Thomson and Stewart (1974).

The chemical form of selenium may play a role in determining how rapidly selenium is excreted in the urine. In rats, the rate of urinary excretion of selenium has been found to be greater following oral administration of sodium selenite than of selenomethionine (Thomson and Stewart 1973). A comparison of excretion of selenium by selenium-depleted rats after oral administration of sodium selenate, selenomethionine, or methyl selenocysteine (from high-selenium broccoli) found that excretion of selenium from methyl selenocysteine or selenomethionine was significantly lower than from sodium selenate; further, that there was no significant difference between secretion of selenium from methyl selenocysteine and selenomethionine (Finley 1998). This may contribute to the greater retention of selenium from selenomethionine, than from inorganic selenium (Martin et al. 1989a). However, another study of excretion of selenium from rats fed selenium as either sodium selenite or selenomethionine found that excretion of selenium increased with administered dose, but was similar for both forms of selenium (Shiobara et al. 1998).

3. HEALTH EFFECTS

As exposure to oral L-selenomethionine increased in macaques, the amount of selenium eliminated in the urine/day increased, as did the maximum rate of urinary excretion. However, the percentage of administered dose appearing in the urine decreased with an increase in dose (Hawkes et al. 1994).

3.4.4.3 Dermal Exposure

No studies were located regarding the excretion of selenium by humans or other animals after dermal exposure to elemental selenium or selenium compounds.

3.4.4.4 Other Routes of Exposure

Whole body retention studies in sheep following injection of selenium have indicated that selenium excretion in animals follows a triexponential profile (Blodgett and Bevill 1987b; Ewan et al. 1967). In a 2-week study, Blincoe (1960) estimated the half-life for ⁷⁵Se in rats following intraperitoneal injection of ⁷⁵Se-labeled sodium selenite (0.93 mg selenium/kg). Initially, the excretion of selenium was rapid, with a half-life of approximately 0.8 day; the second phase of excretion was slower, with a half-life of 13 days. These results parallel the initial phases of selenium excretion seen in humans. The abbreviated duration of the Blincoe (1960) study did not permit the determination of a terminal elimination phase half-life. In rats, Ewan et al. (1967) found the final phase of elimination of selenium following a single subcutaneous injection of sodium selenite to be dose independent (from 0.008 mg selenium/kg to 2 mg selenium/kg), with a half-life of 65–78 days. Blodgett and Bevill (1987b) found the elimination rate of selenium in sheep during the second phase following a single intramuscular injection of sodium selenite to be dose dependent, with larger doses resulting in longer half-lives (i.e., doses of 0.4, 0.6, 0.7, or 0.8 mg selenium/kg resulting in half-lives for selenium elimination of 6.3, 8.8, 15.1, and 20.4 hours, respectively). The reasons for the decreasing elimination rate with increasing dose during the second phase are not clear.

Dietary levels of selenium and the individual's selenium nutritional status are the most important factors that influence the route and rate of selenium excretion. Selenium excretion in expired air is only significant when exposures to selenium are high. Rats injected subcutaneously with sodium selenite at doses of 2.2–5.4 mg selenium/kg excreted 41–62% of the administered selenium in exhaled air, whereas rats injected with sodium selenite at doses of 0.005–0.9 mg selenium/kg excreted only 0.2–11% of the

3. HEALTH EFFECTS

administered selenium in expired air (McConnell and Roth 1966; Olson et al. 1963). As the amount of administered sodium selenite increased, the percent of the administered selenium excreted in the urine decreased (from approximately 22–33% of the administered selenium at doses of 0.005–0.9 mg selenium/kg to 3–14% of the administered selenium at doses of 3.1–5.4 mg selenium/kg) (McConnell and Roth 1966). Selenium in the feces was not measured in this study. Burk et al. (1972) found that as the dietary level of sodium selenite was increased, a larger proportion of an injected tracer dose of selenium (as sodium selenite) was excreted. At a dietary level of 0.005 mg selenium/kg, approximately 60% of the injected selenium had been excreted in the first 35 days following administration. At a dietary level of 0.05 mg selenium/kg, over 94% of the injected selenium had been excreted over the same period of time.

In experimental animals, other factors that can cause an increase in selenium levels in expired air are higher dietary levels of selenium, protein, or methionine (Ganther et al. 1966). Phenobarbital induction of microsomal enzymes has also led to increased exhalation of selenium following intravenous administration of sodium selenite (Sternberg et al. 1968).

3.4.5 Physiologically Based Pharmacokinetic (PBPK)/Pharmacodynamic (PD) Models

Physiologically based pharmacokinetic (PBPK) models use mathematical descriptions of the uptake and disposition of chemical substances to quantitatively describe the relationships among critical biological processes (Krishnan et al. 1994). PBPK models are also called biologically based tissue dosimetry models. PBPK models are increasingly used in risk assessments, primarily to predict the concentration of potentially toxic moieties of a chemical that will be delivered to any given target tissue following various combinations of route, dose level, and test species (Clewell and Andersen 1985). Physiologically based pharmacodynamic (PBPD) models use mathematical descriptions of the dose-response function to quantitatively describe the relationship between target tissue dose and toxic end points.

PBPK/PD models refine our understanding of complex quantitative dose behaviors by helping to delineate and characterize the relationships between: (1) the external/exposure concentration and target tissue dose of the toxic moiety, and (2) the target tissue dose and observed responses (Andersen et al. 1987; Andersen and Krishnan 1994). These models are biologically and mechanistically based and can be used to extrapolate the pharmacokinetic behavior of chemical substances from high to low dose, from route to route, between species, and between subpopulations within a species. The biological basis of

3. HEALTH EFFECTS

PBPK models results in more meaningful extrapolations than those generated with the more conventional use of uncertainty factors.

The PBPK model for a chemical substance is developed in four interconnected steps: (1) model representation, (2) model parametrization, (3) model simulation, and (4) model validation (Krishnan and Andersen 1994). In the early 1990s, validated PBPK models were developed for a number of toxicologically important chemical substances, both volatile and nonvolatile (Krishnan and Andersen 1994; Leung 1993). PBPK models for a particular substance require estimates of the chemical substance-specific physicochemical parameters, and species-specific physiological and biological parameters. The numerical estimates of these model parameters are incorporated within a set of differential and algebraic equations that describe the pharmacokinetic processes. Solving these differential and algebraic equations provides the predictions of tissue dose. Computers then provide process simulations based on these solutions.

The structure and mathematical expressions used in PBPK models significantly simplify the true complexities of biological systems. If the uptake and disposition of the chemical substance(s) is adequately described, however, this simplification is desirable because data are often unavailable for many biological processes. A simplified scheme reduces the magnitude of cumulative uncertainty. The adequacy of the model is, therefore, of great importance, and model validation is essential to the use of PBPK models in risk assessment.

PBPK models improve the pharmacokinetic extrapolations used in risk assessments that identify the maximal (i.e., the safe) levels for human exposure to chemical substances (Andersen and Krishnan 1994). PBPK models provide a scientifically sound means to predict the target tissue dose of chemicals in humans who are exposed to environmental levels (for example, levels that might occur at hazardous waste sites) based on the results of studies where doses were higher or were administered in different species. Figure 3-7 shows a conceptualized representation of a PBPK model.

Two models for selenium were located in the literature. Patterson and coworkers (Patterson and Zech 1992; Patterson et al. 1989, 1993) have developed compartmental models of the kinetics of selenium orally administered as selenite or selenomethionine in adult humans.

3. HEALTH EFFECTS

Figure 3-7. Conceptual Representation of a Physiologically Based Pharmacokinetic (PBPK) Model for a Hypothetical Chemical Substance

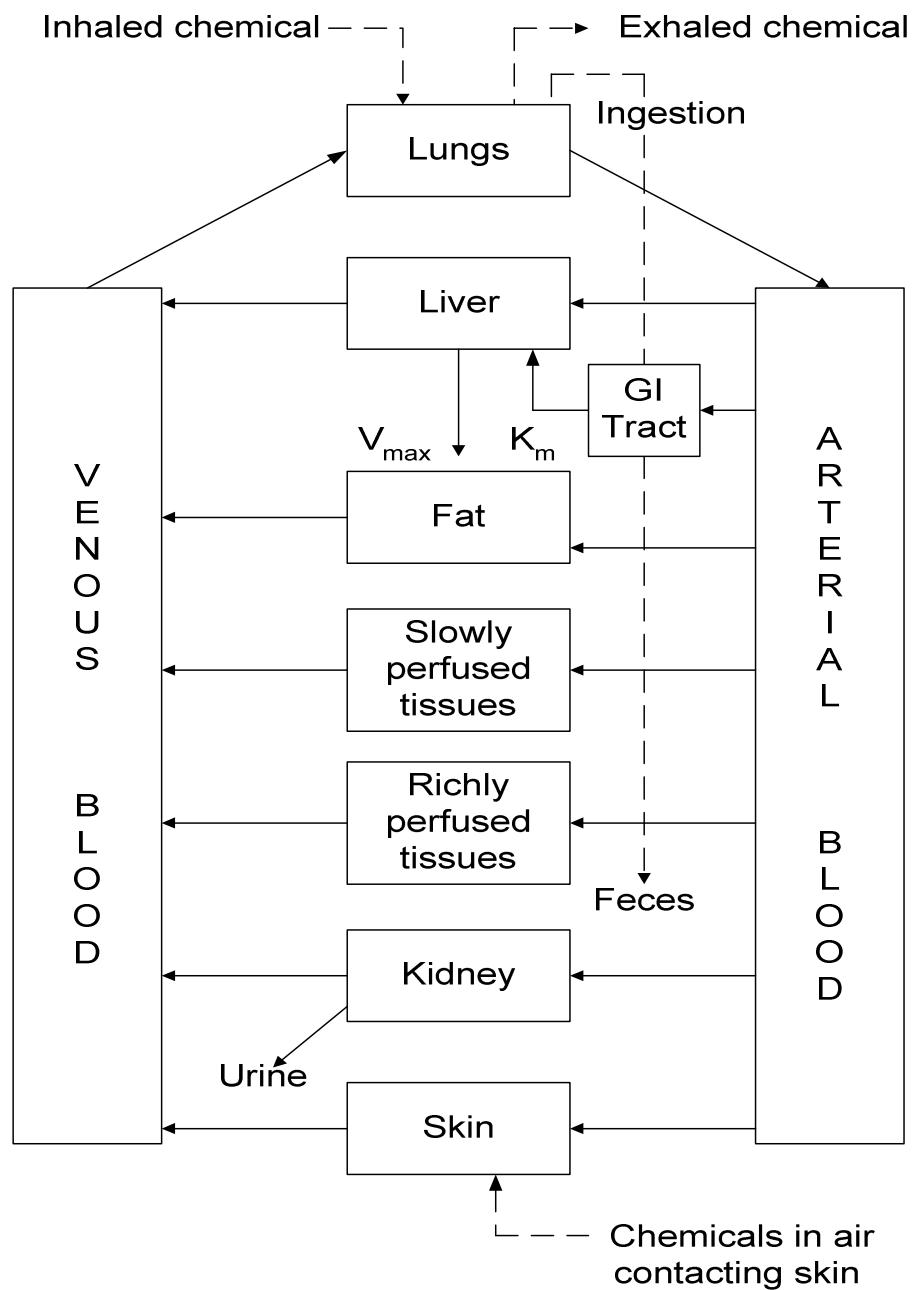

Source: adapted from Krishnan et al. 1994

Note: This is a conceptual representation of a physiologically based pharmacokinetic (PBPK) model for a hypothetical chemical substance. The chemical substance is shown to be absorbed via the skin, by inhalation, or by ingestion, metabolized in the liver, and excreted in the urine or by exhalation.

3. HEALTH EFFECTS

Patterson et al. (1989) Selenite Model

Description of the model. Patterson and coworkers (Patterson and Zech 1992; Patterson et al. 1989, 1993) developed a compartmental model of the kinetics of ingested selenite in adult humans based on data from human subjects who consumed a single oral dose of 200 μg ^{74}Se as selenite. The model assumes that 84% of the administered selenium is absorbed and that absorption is rapid. Absorbed selenite is assumed to distribute to six compartments: gastrointestinal tract, plasma, hepatopancreatic/lymphatic system, liver/pancreas, bile, and tissues (Figure 3-8). Unabsorbed selenium is excreted in the feces. Absorption occurs from the gastrointestinal compartment (probably the small intestine, but also possibly the stomach) into a rapidly turning-over pool (the intestinal cells or enterocytes) from which it leaves by two pathways. The central compartment is represented as four kinetically distinct plasma pools, P1 (the portal circulation), P2 (before passage through the liver), P3 (after passage through the liver), and P4 (after passage through the tissues). In the first pathway, selenium enters P1. The second pathway is to a liver/pancreatic compartment. Transport into and out of P1 is very rapid ($T_{1/2}$ approximately 0.36 hours) and this may represent selenium in the portal circulation passing through the liver before appearing in P3, but not removed in the first pass. The second pathway is via the hepatopancreatic/lymphatic system compartment to a second plasma pool (P2). Appearance of selenium in P2 is delayed ($T_{1/2}$ approximately 0.55 hours), representing the time needed to move through the hepatopancreatic/lymphatic system compartment. From the two plasma pools (P1 and P2), selenium can be excreted in the urine ($T_{1/2}$ approximately 3.94 and 1.96 hours, respectively) or it can move into the liver/pancreas compartment. After a delay of 4–6 hours, the selenium leaves the liver/pancreas either to a bile compartment ($T_{1/2}$ approximately 0.13 hours) and thence to the gut (G1) for excretion in feces or to a third plasma pool (P3) ($T_{1/2}$ approximately 0.19 hours). From P3, selenium can be excreted in the urine ($T_{1/2}$ approximately 4.15 hours) or can move into a large, slowly turning-over tissue compartment. Finally, selenium is transferred very slowly ($T_{1/2}$ approximately 1.27 hours) from the tissues (probably final metabolic products) to a fourth plasma pool (P4) and hence to the urine ($T_{1/2}$ approximately 6.54 hours).

Validation of the model. The extent to which this model has been validated is not described in Patterson and coworkers (Patterson and Zech 1992; Patterson et al. 1991, 1993).

Risk assessment. The model was designed to simulate the pharmacokinetics of selenium orally administered as selenite to humans as a preparation for a larger anticancer supplementation study jointly undertaken by the National Cancer Institute (NCI) and the U.S. Department of Agriculture (USDA) (Patterson and Zech 1992; Patterson et al. 1991, 1993).

3. HEALTH EFFECTS

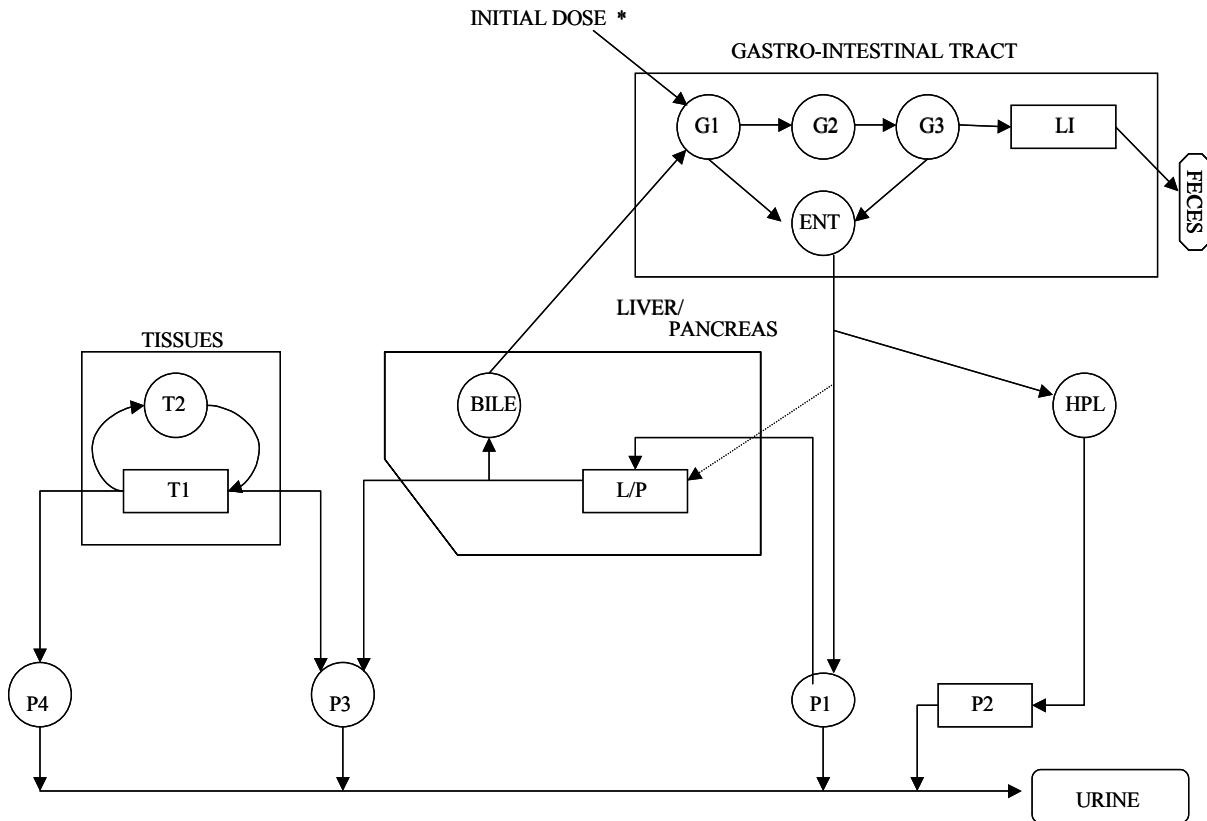
Figure 3-8. Selenite Model, a Kinetic Model for Selenite Metabolism

The arrow with an asterisk indicates the site of entry of the oral Se tracer. Arrows between compartments represent pathways of fractional transport. Compartments depicted as rectangles represent delays. Compartments G1, G2, G3, three-gut compartments, probably the small intestine; ENT, enterocytes (intestinal cells); HPL, compartment in hepato-pancreatic subsystem or lymphatic system; L/P, liver and pancreas; LI, large intestine; T1, T2, peripheral tissues, e.g., skeletal muscle, bone, kidney. Feces and urine compartments are drawn in the shape of test tubes to represent fractional (single) collections. The model includes absorption distributed along the gastrointestinal tract, enterohepatic recirculation, four-kinetically distinct plasma pools, P1–P4, a subsystem consisting of liver and pancreas, and a slowly turning-over tissue pool.

Source: Patterson et al. 1993

3. HEALTH EFFECTS

Target tissues. The model is designed to simultaneously account for the appearance and disappearance of selenium in plasma, urine, and feces after administration of a single oral dose of ^{74}Se as selenite (Patterson and Zech 1992; Patterson et al. 1991, 1993).

Species extrapolation. The model is designed for applications to human dosimetry and cannot be applied to other species without modification.

Interroute extrapolation. The model is designed to simulate oral exposures to selenite and cannot be applied to other routes of exposure without modification.

Extrapolation to other forms of selenium. The model is designed to simulate oral exposures to selenite and cannot be applied to other forms of selenium without modification.

Swanson et al. (1991) Selenomethionine Model

Description of the model. Swanson and coworkers (Patterson et al. 1993; Swanson et al. 1991) produced a model for ingested selenomethionine in adult humans based on data from human subjects who consumed a single oral dose of $200\ \mu\text{g}\ ^{74}\text{Se}$ as selenomethionine and the model of the kinetics of ingested selenite described above. Four major changes (indicated by bold lines in Figure 3-9) were made to the selenite model to achieve an adequate fit to the selenomethionine data: (1) the amount of label absorbed into the enterocyte was increased (the absorption of ^{74}Se was 98% for selenomethionine compared with 84% for selenite), (2) the amount of label removed from the plasma in the first pass through the liver was increased, (3) a pathway from P4 back to the liver was added, providing for conservation and reutilization of amino acids (estimated 95% of material from P4 is recycled), and (4) a second tissue subgroup was added to the model and rate constants were adjusted so that the subgroups had different turnover times.

The most important differences between the selenite and selenomethionine models lie in the turnover times. The estimated turnover times in the plasma, liver/pancreas, and tissues are shorter for selenomethionine than for selenite, but the estimated turnover time for the whole body is more than twice as long for selenomethionine as for selenite. This is probably because selenite is not recirculated, whereas selenomethionine is extensively recycled, passing through the individual organs and tissues many times before being excreted.

3. HEALTH EFFECTS

Figure 3-9. Selenomethionine Model, a Kinetic Model for Selenomethionine Metabolism

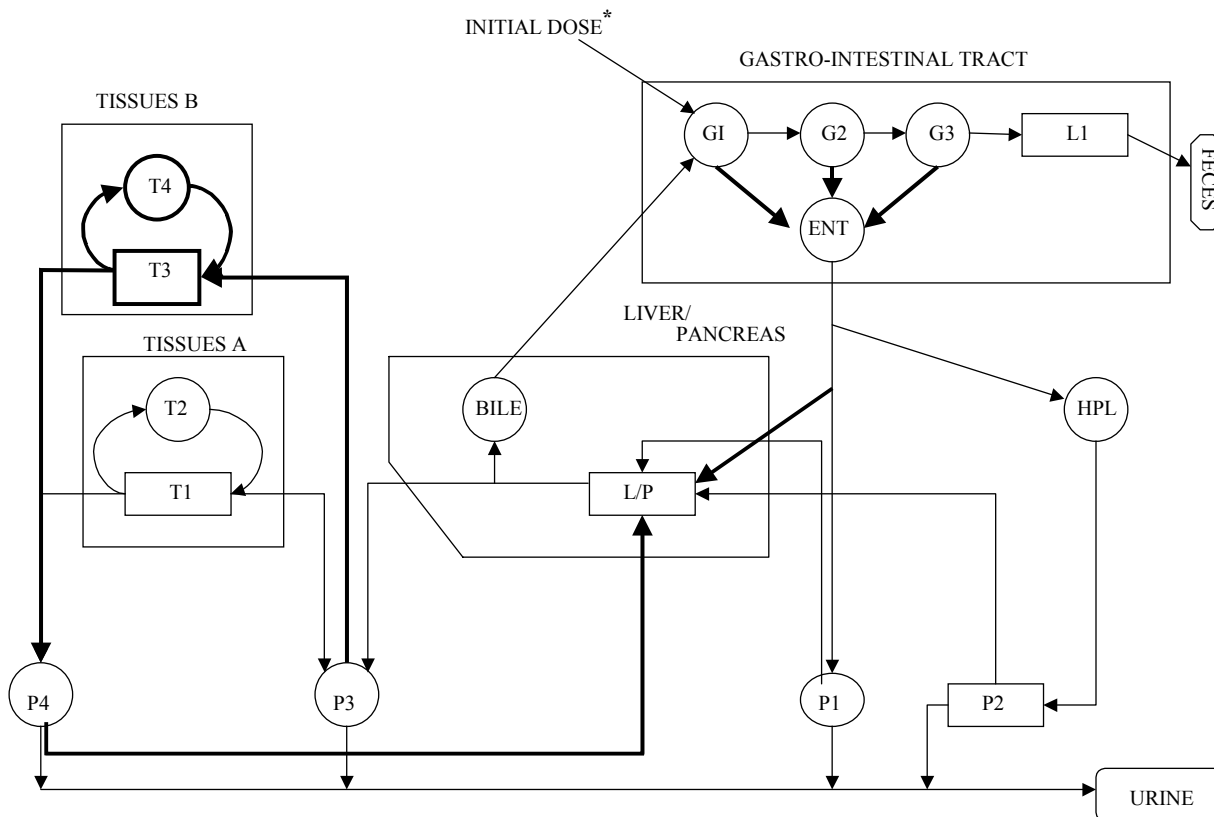

The arrow with an asterisk indicates the site of the oral Se tracer. Arrows between compartments represent pathways of fractional transport. Compartments depicted as rectangles represent delays. G1, G2, G3, three-gut compartments, probably small intestine; ENT, enterocytes (intestinal cells); HPL, compartment in hepatopancreatic subsystems or lymphatic system; L/P, liver and pancreas; L1, large intestine; T1, T2, T3, T4, peripheral tissues, e.g., skeletal muscle, bone, kidney. Feces and urine along the gastrointestinal tract, enterohepatic recirculation, four-kinetically distinct plasma pools, P1–P4, a subsystem consisting of the liver and pancreas, two tissue subsystems that are slowly turning-over, and a pathway for reutilization of selenium metabolites from peripheral tissues. The bold lines indicate the major modifications to the Selenite Model (Figure 3-8).

Source: Patterson et al. 1993

3. HEALTH EFFECTS

Validation of the model. The extent to which this model has been validated is not described by the authors (Patterson et al. 1993; Swanson et al. 1991).

Risk assessment. The model was designed to simulate the pharmacokinetics of selenium orally administered as selenomethionine to humans as a preparation for a larger anti-cancer supplementation study jointly undertaken by the NCI and the USDA (Patterson et al. 1993; Swanson et al. 1991).

Target tissues. The model is designed to simultaneously account for the appearance and disappearance of selenium in plasma, urine, and feces after administration of a single oral dose of ^{74}Se as selenomethionine (Patterson et al. 1993; Swanson et al. 1991).

Species extrapolation. The model is designed for applications to human dosimetry and cannot be applied to other species without modification.

Interoute extrapolation. The model is designed to simulate oral exposures to selenomethionine and cannot be applied to other routes of exposure without modification.

Extrapolation to other forms of selenium. The model is designed to simulate oral exposures to selenomethionine and cannot be applied to other forms of selenium without modification.

3.5 MECHANISMS OF ACTION

3.5.1 Pharmacokinetic Mechanisms

As discussed in Section 3.4.1, selenium is readily absorbed by inhalation or ingestion when present in any of several compounds. Inhalation and oral absorption are extensive, although the rate of absorption varies depending on the form of selenium (Medinsky et al. 1981a; Moser-Veillon et al. 1992; Swanson et al. 1991; Weissman et al. 1983; Young et al. 1982). Oral bioavailability is generally independent of the exposure level, but may be increased in some selenium-deficient individuals (Griffiths et al. 1976; Martin et al. 1989a; Thomson 1974; Thomson et al. 1977). Selenate and selenomethionine appear to be absorbed by the intestine largely unchanged, while selenite and selenocysteine are metabolized during absorption (Hasegawa et al. 1995, 1996b; Spencer and Blau 1962; Whanger et al. 1976, 1996). No evidence of significant dermal absorption of selenium by humans was located, although mice can absorb topically-applied selenomethionine (Burke et al. 1992b). An active transport mechanism for selenomethionine

3. HEALTH EFFECTS

absorption in the intestine has been described (Spencer and Blau 1962), but mechanisms of absorption and distribution for dermal and pulmonary uptake are unknown and subject to speculation.

Absorbed selenium is carried throughout the body in the blood, eventually being distributed to all tissues. Injection studies in humans have shown that after selenium enters the blood, it rapidly becomes protein-bound (Burk 1974; Hirooka and Galambos 1966a), while *in vitro* studies have shown that selenite is accumulated in erythrocytes via an active transport mechanism (Lee et al. 1969). Selenium is an essential element and is incorporated into selenoproteins (e.g., glutathione peroxidase, iodothyronine deiodinases) as selenocysteine. Most studies report similar distribution patterns for selenium, regardless of the form in which it was administered; however, the concentration reached is generally higher for doses delivered as an organic form of selenium, such as selenomethionine, than for the same dose delivered as an inorganic form (Behne et al. 1991; Butler et al. 1990; Grønbaek and Thorlacius-Ussing 1992; Ip and Hayes 1989; Salbe and Levander 1990b; Shiobara et al. 1998; Zi-Jian Jie 1992). In humans, the highest levels of selenium are found in the liver and kidney (see Table 3-6 for normal levels of selenium in human tissues). Selenomethionine is not synthesized by humans, but can be incorporated into proteins in the place of methionine; because of this, selenomethionine is retained for a longer time within the body than inorganic forms, and it may therefore represent a storage form of the element. Unlike selenomethionine, there is no evidence that selenocysteine and inorganic selenium (selenate) are incorporated non-specifically into plasma protein, suggesting that these forms are metabolized by specific selenium metabolic processes. For example, selenocysteine seems to incorporate selenium into selenoproteins, but not into other proteins in place of cysteine (Burk et al. 2001).

Selenium and the glutathione (GSH) system have key functions in the body's antioxidant defense (Arteel and Sies 2001; Brigelius-Flohe 1999). GSH is involved in direct interception of pro-oxidants, as well as the reduction of other antioxidants from their oxidized forms (Arteel and Sies 2001). GSH also has ancillary functions (e.g., metabolism, cell signaling, and protein interactions) that can mediate defense against antioxidants. The redox reactions of GSH involve glutathione peroxidase (GPX) and glutathione disulfide (GSSG) as catalysts, whereas the main class of enzymes involved in thioether formation are the GSH transferases. Antioxidant protection by selenium in the mammalian cell is mediated by selenoamino acids, either as selenocysteine or selenomethionine. Selenomethionine has GPX-like activity, and the active site of GPX contains selenocysteine residues. GPX catalyzes the reduction of various kinds of hydroperoxides (e.g., simple hydroperoxides, lipid peroxides) by using GSH as the reducing substrate. Several isozymes of GPX have been identified, including plasma GPX, gastrointestinal GPX, and phospholipid hydroperoxide GPX (reduces lipid hydroperoxides found in biomembranes and sperm)

3. HEALTH EFFECTS

(Brigelius-Flohe 1999). Other selenoproteins (e.g., selenoprotein P and thioredoxin reductase) also have been shown to have antioxidant properties, and can function in the defense against peroxynitrite, by reducing this oxidizing and nitrating species into nitrite (Arteel and Sies 2001; Holmgren and Kumar 1989; Burke and Hill 2000; Ganther 1999).

The antioxidant action of GPX towards hydroperoxides appears to involve an enzymatic catalysis reaction cycle (a 'tert-uni ping-pong' mechanism) (Arteel and Sies 2001). The reaction cycle is thought to proceed in three main steps, involving the enzyme-bound selenocysteine, which is present as the selenol. In the first step of the reaction, the organic hydroperoxide reacts to yield selenenic acid and the corresponding alcohol. The remaining steps consist of the sequential reduction by thiols (GSH), leading to regeneration of the selenol and glutathione disulfide. GPX serves more as an ancillary reductant than as a direct antioxidant *per se*.

Deiodination is an important mechanism for the deactivation of the thyroid hormones, T_4 and T_3 , as well as for the production of extrathyroidal thyroid T_3 . The deiodination reactions are catalyzed by selenium-dependent deiodinase enzymes (selenodeiodinases). Three selenodeiodinases have been described that differ in substrate preference, reaction products, response to inhibitors, and response to T_3 (Larsen et al. 1998). Full activity of each enzyme requires selenocysteine in the amino acid sequence of the active site, which is the basis for deiodination activity being responsive to nutritional selenium status (see Section 3.9).

Excretion of selenium by humans occurs in the urine, feces, expired air, and sweat, but urine and feces are the major routes of elimination. Some of the selenium in feces may be due to biliary excretion (Levander and Baumann 1966a, 1966b). Elimination is reduced in selenium-deficient individuals and may represent a mechanism by which selenium levels are regulated (Martin et al. 1989a; Swanson et al. 1991).

Methylation is an important mechanism of detoxification for selenium; dimethyl selenide is exhaled, and the trimethylselenonium ion is the major urinary metabolite of selenium. Experiments in mice suggest that the hepatic toxicity of selenium may be at least partly due to depression of selenium methylation in the liver, resulting in the accumulation of excess selenides (Nakamuro et al. 2000).

3.5.2 Mechanisms of Toxicity

Selenium in the body can be grouped in three main categories: selenium in proteins, non-protein selenium species, and selenoamino acids (Lobinski et al. 2000). The most prevalent selenium species

3. HEALTH EFFECTS

include selenocysteine, selenomethionine, and inorganic forms of selenium (selenite and selenate). Selenocysteine-containing proteins are particularly important because they are largely responsible for the antioxidant properties of selenium. The main selenoproteins are glutathione peroxidase (GPX), thioredoxin reductase, and iodothyronine 5'-deiodinases, and the activity of these selenocysteine enzymes generally decreases and increases when selenium is depleted or repleted (Lobinski et al. 2000). Selenium can also be incorporated directly into non-specific proteins in the place of methionine (i.e., as selenomethionine), which contributes to the pool of selenomethionine-rich proteins present in human and animal tissues, or become part of selenium-binding proteins in which selenium is not covalently bound to the molecules (Arteel and Sies 2001; Bansal et al., 1989, 1990; Gladyshev and Kryukov 2001; Lobinski et al. 2000; Sani et al., 1988).

Little is known about the specific biochemical mechanism(s) by which selenium and selenium compounds exert their acute toxic effects. Generally, water-soluble forms are more easily absorbed and are generally of greater acute toxicity. Several mechanisms have been proposed to explain the various long-term toxic effects of excess selenium, such as alterations in the hair, skin, nails, liver, thyroid, and nervous system, as discussed below. This includes information on mechanisms by which selenium exerts effects as a component of GPX, thioredoxin reductase, and the iodothyronine deiodinases, although the roles of other selenium-containing proteins in mammalian metabolism have not been clarified. Selenium also has strong interactions with other nutrients such as vitamin E, toxic metals such as mercury and cadmium, and various xenobiotics (see Section 3.9).

Selenium readily substitutes for sulfur in biomolecules and in many biochemical reactions, especially when the concentration of selenium is high and the concentration of sulfur is low in the organism (Stadtman 1983; Raisbeck 2000). Inactivation of the sulfhydryl enzymes necessary for oxidative reactions in cellular respiration, through effects on mitochondrial and microsomal electron transport, might contribute to acute selenium toxicity (Levander 1982; Lombeck et al. 1987; Mack 1990; Shamberger 1981). Selenium may have a role in hepatic heme metabolism that is related to GPX or lipid peroxidation (Levander 1982). Selenocysteine is specifically found in some proteins (e.g., glutathione peroxidase); selenomethionine appears to randomly substitute for methionine in protein synthesis. This appears to be an additional mechanism for intermediate- or chronic-duration toxicity (Levander 1982; Stadtman 1983; Tarantal et al. 1991). Skin, hair, and nail damage are significant indicators of chronic selenium overexposure. The mechanism causing these integumentary effects is unclear, but could be related to the high selenium concentrations in these tissues as a consequence of the substitution of selenium for sulfur in certain amino acids, including the disulfide bridges that provide tertiary structure and function to

3. HEALTH EFFECTS

proteins. For example, substitution of selenium for sulfur in keratin results in weakened physical protein structure and failure of keratinized tissues such as hair and hoof (Raisbeck 2000). The nails and hair are considered to be routes for excretion of excess selenium (Yang et al. 1989b).

Considerable evidence is available supporting oxidative stress as the key biochemical lesion of selenium intoxication (Raisbeck 2000; Spallholz et al. 1994). Inorganic forms of selenium appear to react with tissue thiols by redox catalysis resulting in formation of reactive oxygen species (superoxide anion $[O_2^-]$). For example, selenite is a prooxidant catalyst that reacts with GSH endogenously in cells or extracellularly causes toxicity by the formation of superoxide and elemental selenium (Seko and Imura 1997; Seko et al. 1989; Spallholz 1994). Selenocystamine (a diselenide) catalyzes the formation of superoxide under aerobic conditions in the presence of thiol; this reaction could play a role in the toxicity of diselenides and alkylselenols (Chaudiere et al. 1992). Selenium can have inhibitory effects on thiol proteins by modification via (1) formation of S-Se-S (selenotrisulfides) and S-Se (selenylsulfide) bonds, (2) catalysis of S-S (disulfide bonds) with no incorporation of selenium in the protein, and (3) formation of Se-Se diselenides (Ganther 1999). Proteins that contain regulatory cysteines can similarly form selenium adducts with toxicity resulting from inactivation of essential thiol groups.

Selenium can also play a role in the redox-regulating activities of GPXs with inflammatory superoxides and phospholipid hydroperoxides. A selenoprotein P-supported plasma GPX could bind to endothelial cells and protect them against inflammatory hydroperoxides (Hill and Burke 1989, 1997). Metabolites from reactions of GPX and phospholipid hydroperoxides could suppress cytokine or growth factor triggered gene activation (Flohe et al. 1997). Selenium appears to be a key element that, through its modulation of GPX activity, can inhibit activation of the transcription factor NF- κ B, which is involved in the regulation of the expression of numerous cellular genes, particularly those involved in immune, inflammatory, and stress responses (Kretz-Remy and Arrigo 2001).

Apoptosis induced by tumor necrosis factor might be inhibited by overexpression of cytosolic GPX or phospholipid hydroperoxide GPX because the apoptotic signaling cascade could be stimulated by hydroperoxides (Brigelius-Flohe 1999). Selenium compounds that form the methylselenide anion (selenol) have been shown to induce cellular apoptosis, and one selenium compound, selenium-methylselenocysteine, induced apoptosis in cancer cells through activation of capsases (a likely mechanism for other selenium compounds that also induce apoptosis) (Ganther 1999; Spallholz 2001). Hypotheses for the protective role of selenium against cancer development include the inhibition of carcinogen-induced covalent DNA adduct formation, retardation of oxidative damage to DNA, lipids, and proteins, and

3. HEALTH EFFECTS

modulation of cellular and molecular events that are critical in cell growth inhibition and in the multi-step carcinogenesis process (El-Baoumy 2001; Ganther 1999; Spallholz 2001).

Intracellular redox function can also be affected by selenium deficiency. In general, the toxicity of compounds that are metabolized to form free radicals increases in selenium-deficient animals, and many of the effects are prevented by supplements of selenium. For example, the active role of selenium in thioredoxin reductase helps reduce nucleotides in DNA synthesis, and selenium in GPX reduces phospholipid hydroperoxides and hydrogen peroxide (Ganther 1999; Holmgren and Kumar 1989; Spallholz 2001). Peroxidative degradation of polyunsaturated fatty acids in membranes causes formation of chemicals, such as free radicals, aldehydes, and epoxides, which can have cytotoxic, hepatotoxic, and genotoxic effects (Esterbauer et al. 1989). The role of selenium in protecting against early pregnancy loss may be linked to reduced antioxidant protection of biological membranes and DNA by low concentrations of GPX. Levels of hemoglobin adducts from aldehydes and epoxides in selenium-deficient animals were enhanced due to loss of selenium-dependent GPX activity (Kautiainen et al. 2000). Degenerative diseases such as skeletal and cardiac myopathies, which occur particularly in selenium-deficient cattle and sheep, appear to be due to loss of membrane phospholipid hydroperoxide GPX activity (Arthur and Beckett 1994b).

Selenium status can also influence thyroid hormone function via the deiodinase enzymes (Brätter and Negretti De Brätter 1996; Hawkes and Turek 2001). Selenium is a critical component of the deiodinase enzymes, including iodothyronine 5'-deiodinases, which convert the prohormone thyroxine (T_4) to the active circulating form, triiodothyronine (T_3) (Delange 2000; Köhrle 1994; St Germain and Galton 1997). Selenium is also a component of GPX, the main enzyme responsible for protecting thyroid cells against oxidative damage. GPX is involved in the detoxification of hydrogen peroxide, which is produced in the thyroid during the conversion of T_4 to T_3 .

3.5.3 Animal-to-Human Extrapolations

No studies were located that specifically examined species-related differences in selenium pharmacokinetics. Similar patterns of absorption, distribution, and elimination have been reported for human and animal systems and the dermal, endocrine, and neurological effects of chronic exposure in humans are similar to those reported for animals exposed to very high doses of selenium. However, species-specific differences in toxicity are present (e.g., the main effect of selenium toxicity in rodents is

3. HEALTH EFFECTS

damage to the liver, which is not observed in humans) and this may represent evidence of underlying differences in how selenium is metabolized.

3.6 TOXICITIES MEDIATED THROUGH THE NEUROENDOCRINE AXIS

Recently, attention has focused on the potential hazardous effects of certain chemicals on the endocrine system because of the ability of these chemicals to mimic or block endogenous hormones. Chemicals with this type of activity are most commonly referred to as *endocrine disruptors*. However, appropriate terminology to describe such effects remains controversial. The terminology *endocrine disruptors*, initially used by Colborn and Clement (1992), was also used in 1996 when Congress mandated the Environmental Protection Agency (EPA) to develop a screening program for "...certain substances [which] may have an effect produced by a naturally occurring estrogen, or other such endocrine effect[s]...". To meet this mandate, EPA convened a panel called the Endocrine Disruptors Screening and Testing Advisory Committee (EDSTAC), which in 1998 completed its deliberations and made recommendations to EPA concerning *endocrine disruptors*. In 1999, the National Academy of Sciences released a report that referred to these same types of chemicals as *hormonally active agents*. The terminology *endocrine modulators* has also been used to convey the fact that effects caused by such chemicals may not necessarily be adverse. Many scientists agree that chemicals with the ability to disrupt or modulate the endocrine system are a potential threat to the health of humans, aquatic animals, and wildlife. However, others think that endocrine-active chemicals do not pose a significant health risk, particularly in view of the fact that hormone mimics exist in the natural environment. Examples of natural hormone mimics are the isoflavonoid phytoestrogens (Adlercreutz 1995; Livingston 1978; Mayr et al. 1992). These chemicals are derived from plants and are similar in structure and action to endogenous estrogen. Although the public health significance and descriptive terminology of substances capable of affecting the endocrine system remains controversial, scientists agree that these chemicals may affect the synthesis, secretion, transport, binding, action, or elimination of natural hormones in the body responsible for maintaining homeostasis, reproduction, development, and/or behavior (EPA 1997). Stated differently, such compounds may cause toxicities that are mediated through the neuroendocrine axis. As a result, these chemicals may play a role in altering, for example, metabolic, sexual, immune, and neurobehavioral function. Such chemicals are also thought to be involved in inducing breast, testicular, and prostate cancers, as well as endometriosis (Berger 1994; Giwercman et al. 1993; Hoel et al. 1992).

Selenium is a component of all three members of the deiodinase enzyme family, the enzymes responsible for deiodination of the thyroid hormones (Köhrle 1994; St. Germain and Galton 1997). The deiodinases

3. HEALTH EFFECTS

contain a selenocysteine at the active site, which is required for catalytic activity. There are three types of deiodinases and they differ in terms of tissue distribution, reaction kinetics, efficiency of substrate utilization, and sensitivity to inhibitors. The first to be recognized as a selenoprotein was type I iodothyronine 5'-deiodinase, which converts the prohormone thyroxine (T_4) to the active form, triiodothyronine (T_3) and to date, studies of the effects of excess selenium have focused on this protein. Under normal circumstances, the human thyroid produces only 20–30% of its hormone as T_3 ; the remainder is T_4 (a minute amount of reverse T_3 (rT_3) is also produced), which is largely converted to active T_3 by type I deiodinase located within the liver, euthyroid pituitary, kidney, thyroid, and brain. Type I deiodinase is a membrane bound protein and, thus, its activity has not been directly measured in studies of humans supplemented with selenium. Human studies have instead measured serum levels of T_3 , rT_3 , T_4 , and TSH.

Two human studies have demonstrated a decrease in T_3 levels in response to increased dietary selenium although the hormone levels remained within the normal human range (Brätter and Negretti De Brätter 1996; Hawkes and Turek 2001). The effect of increased dietary selenium on other thyroid hormones is unclear. No significant correlation between selenium intake and serum T_4 or TSH levels was found in the study of Brätter and Negretti De Brätter (1996), although Hawkes and Turek (2001) showed that TSH concentration increased (+37%) and was significantly different relative to baseline levels ($p < 0.06$) in a high selenium group. In a third study of the effects of selenium supplementation, New Zealanders with normally low selenium intake (unsupplemented intake of 28–29 $\mu\text{g}/\text{day}$) showed a reduction in T_4 concentration in all groups after 20 weeks (Duffield et al. 1999). A significant inverse correlation was found between serum levels of selenium and TSH among fish consumers; however, it is not known if this population had a high selenium intake (Hagmar et al. 1998).

Male rats receiving diets supplying 0.05 mg selenium/kg/day for 6–12 weeks have been shown to have reductions in type-I-deiodinase activity (Behne et al. 1992; Eder et al. 1995; Hotz et al. 1997). However, the levels of thyroid hormones in these animals have not shown a consistent pattern. Exposure to 0.055 mg selenium/kg/day as sodium selenite for 40 days produced a significant decrease in serum levels of T_3 (Eder et al. 1995). In another study, a dose of 0.09 mg selenium/kg/day as sodium selenate in food for 6 weeks produced a significant (~30%) increase in TSH (Hotz et al. 1997), and no significant changes in thyroid levels of T_3 or T_4 were found in rats receiving 0.105 mg selenium/kg/day as sodium selenite or 0.118 mg selenium/kg/day as L-selenomethionine for 3 months (Behne et al. 1992).

3. HEALTH EFFECTS

Many studies have documented reduced body weight gain in young animals treated with selenium compounds and abnormal weight loss in older animals (Grønbaek et al. 1995; Halverson et al. 1966; Harr et al. 1967; Jacobs and Forst 1981a; Nelson et al. 1943; NTP 1994; Johnson et al. 2000; Palmer and Olson 1974; Panter et al. 1996; Schroeder 1967; Tsunoda et al. 2000). There is evidence to suggest that these effects may be due in part to the interactions of selenium or selenium compounds with hormones that regulate normal growth and body weight. Reduced insulin-like growth factor-binding protein-3, growth hormone secretion in response to growth hormone releasing factor, and somatomedin C levels have been reported in rats exposed to sodium selenite in drinking water (Grønbaek et al. 1995; Thorlacius-Ussing et al. 1988), although somatomedin C was not a sensitive end point in humans from a high selenium area of South Dakota (Salbe et al. 1993).

No studies were located regarding adverse effects on human reproduction following oral exposure to elemental selenium or to selenium compounds. However, data from animal studies suggest that oral exposure to selenium may be associated with male infertility. Adverse effects associated with selenium exposure include decreased sperm counts in rats and rabbits (El-Zarkouny et al. 1999; Kaur and Parshad 1994; NTP 1994), sperm abnormalities in rats and rabbits (El-Zarkouny et al. 1999; Kaur and Parshad 1994), testicular hypertrophy in rats (Turan et al. 1999a), and a significant reduction in serum testosterone in rabbits (El-Zarkouny et al. 1999). However, it is not clear what effect, if any, this had on the ability of the animals to reproduce, as chronic administration of selenate did not affect male fertility in rats or mice (Rosenfeld and Beath 1954; Schroeder and Mitchener 1971b).

Chronic exposure of mice and rats to otherwise nontoxic doses has been shown to reduce fertility and to markedly reduce the viability of the offspring of pairs that are able to conceive (Schroeder and Mitchener 1971b; Wahlstrom and Olson 1959b). Selenium exposure has been shown to alter the length of the estrous cycle in female mice (Nobunaga et al. 1979) and to alter the menstrual cycle in monkeys (Cukierski et al. 1989). Vaginal cytology of female rats provided with drinking water containing selenate or selenite indicated that the rats spent more time in diestrus and less time in proestrus and estrus than the controls (NTP 1994). However, it is not clear what effect, if any, this had on the ability of the animals to reproduce.

Fertility studies in mice, rats, and pigs have demonstrated reduced rates of conception after oral treatment with selenium as selenate or selenite (Rosenfeld and Beath 1954; Schroeder and Mitchener 1971b; Wahlstrom and Olson 1959b). Decreased conception rates and increased resorption rates have been reported for cattle, sheep, and horses fed diets naturally containing organic selenium compounds and

3. HEALTH EFFECTS

exhibiting symptoms of selenosis (Harr and Muth 1972). An increased concentration of progesterone in the milk and an association of cystic ovaries with elevated blood selenium concentrations was observed in cows receiving selenium supplementation (Mohammed et al. 1991).

Other possible examples of endocrine disruption due to selenium exposure include pancreatic damage in sheep and rats fed selenium as sodium selenite, sodium selenate, or seleniferous wheat (Halverson et al. 1966; Harr et al. 1967; Smyth et al. 1990) and decreased plasma glucose (an insulin-like effect) in rats injected with sodium selenate. However, these are isolated reports and it is not clear what relevance they have for selenium toxicity in humans.

3.7 CHILDREN'S SUSCEPTIBILITY

This section discusses potential health effects from exposures during the period from conception to maturity at 18 years of age in humans, when all biological systems will have fully developed. Potential effects on offspring resulting from exposures of parental germ cells are considered, as well as any indirect effects on the fetus and neonate resulting from maternal exposure during gestation and lactation. Relevant animal and *in vitro* models are also discussed.

Children are not small adults. They differ from adults in their exposures and may differ in their susceptibility to hazardous chemicals. Children's unique physiology and behavior can influence the extent of their exposure. Exposures of children are discussed in Section 6.6 Exposures of Children.

Children sometimes differ from adults in their susceptibility to hazardous chemicals, but whether there is a difference depends on the chemical (Guzelian et al. 1992; NRC 1993). Children may be more or less susceptible than adults to health effects, and the relationship may change with developmental age (Guzelian et al. 1992; NRC 1993). Vulnerability often depends on developmental stage. There are critical periods of structural and functional development during both prenatal and postnatal life and a particular structure or function will be most sensitive to disruption during its critical period(s). Damage may not be evident until a later stage of development. There are often differences in pharmacokinetics and metabolism between children and adults. For example, absorption may be different in neonates because of the immaturity of their gastrointestinal tract and their larger skin surface area in proportion to body weight (Morselli et al. 1980; NRC 1993); the gastrointestinal absorption of lead is greatest in infants and young children (Ziegler et al. 1978). Distribution of xenobiotics may be different; for example, infants have a larger proportion of their bodies as extracellular water and their brains and livers are

3. HEALTH EFFECTS

proportionately larger (Altman and Dittmer 1974; Fomon 1966; Fomon et al. 1982; Owen and Brozek 1966; Widdowson and Dickerson 1964). The infant also has an immature blood-brain barrier (Adinolfi 1985; Johanson 1980) and probably an immature blood-testis barrier (Setchell and Waites 1975). Many xenobiotic metabolizing enzymes have distinctive developmental patterns. At various stages of growth and development, levels of particular enzymes may be higher or lower than those of adults, and sometimes unique enzymes may exist at particular developmental stages (Komori et al. 1990; Leeder and Kearns 1997; NRC 1993; Vieira et al. 1996). Whether differences in xenobiotic metabolism make the child more or less susceptible also depends on whether the relevant enzymes are involved in activation of the parent compound to its toxic form or in detoxification. There may also be differences in excretion, particularly in newborns who all have a low glomerular filtration rate and have not developed efficient tubular secretion and resorption capacities (Altman and Dittmer 1974; NRC 1993; West et al. 1948). Children and adults may differ in their capacity to repair damage from chemical insults. Children also have a longer remaining lifetime in which to express damage from chemicals; this potential is particularly relevant to cancer.

Certain characteristics of the developing human may increase exposure or susceptibility, whereas others may decrease susceptibility to the same chemical. For example, although infants breathe more air per kilogram of body weight than adults breathe, this difference might be somewhat counterbalanced by their alveoli being less developed, which results in a disproportionately smaller surface area for alveolar absorption (NRC 1993).

Selenium is known to be an essential micronutrient for humans and animals; therefore, inadequate as well as excessive selenium intake can cause adverse health effects. The Food and Nutrition Board of the National Research Council has established adequate intakes (AI) of 15–20 µg/day for infants based on the selenium content of milk of well nourished, but unsupplemented, mothers (NAS 2000). No data were available on which to base RDAs for children or adolescents; thus, the RDAs for children and adolescents are extrapolated from adult values. Studies of selenium deficient populations suggest that children are more susceptible to the effects of selenium deficiency and have the highest need for selenium of any individuals in the population (Chen et al. 1980; Yang et al. 1988). Premature and full-term infants generally have significantly lower blood selenium levels than their mothers and/or normal adults (Gathwala and Yadav 2002). Infants born prematurely have lower hepatic selenium stores than term infants at birth, indicating that premature infants are at particular risk for the development of a deficiency state if adequate selenium is not provided in the diet (Bayliss et al. 1985).

3. HEALTH EFFECTS

Limited information is available relevant to the toxicity of selenium in children. Observations from the early literature, particularly in livestock and chickens, suggest that young animals are less resistant to selenium than older ones (NAS 1976a; Rosenfeld and Beath 1964b), and a study in rats found that weanlings accumulated more selenium in their tissues than adults (Salbe and Levander 1989). In contrast, the available information in humans suggests that children may be less susceptible to toxic effects of selenium than adults. Most data come from children living in areas of chronic high dietary selenium intake (Yang et al. 1989a, 1989b). Children (aged 3–12 years) in a seleniferous area of China were found to have a significantly higher intake of selenium than the adults in their community, but a corresponding increase in blood levels of selenium appeared only in the children aged 7–12. When the incidence of selenosis in different age groups was examined, it was found that 97% of cases were older than 18 years, and no cases were observed in children below 12 years of age, even though selenium intakes per kg body weight and blood selenium levels in these age groups were found to be either higher than or equal to those of affected adults. One study of children living in a seleniferous area of Venezuela found a significant increase in the percentage of children showing lower than normal height compared with controls from a nonseleniferous area (Brätter et al. 1991a). However, these children also had very low intakes of zinc compared with controls (10–25% of controls), and it is likely that their reduced growth rate is due to inadequate intake of zinc. Another study that compared children from seleniferous and non-seleniferous areas of Venezuela found slightly reduced height, weight, hemoglobin levels, and hematocrit values for the children from the seleniferous area (no statistical analysis was performed), although no clinical signs of selenosis were observed (Jaffe et al. 1972). However, the children from the seleniferous zone had a poorer diet, consumed less milk and meat, and had a greater incidence of intestinal parasites, which may account for the differences observed.

No adverse developmental effects of excess selenium have been reported for humans. Excess selenium is a demonstrated teratogen in birds (Franke and Tully 1935; Franke et al. 1936; Gruenwald 1958; Khan and Gilani 1980; Palmer et al. 1973), but there is no clear evidence linking selenium exposures to developmental effects in mammals. Malformations have been reported for livestock that consumed naturally high seleniferous diets (Dinkel et al. 1963; Rosenfeld and Beath 1964), but it is not clear that these reports took into account consumption of other toxic range plants. Other studies of developmental effects in livestock receiving controlled diets with known amounts of selenium have generally not observed abnormalities, reduced birth weights, or increased mortality (Panter et al. 1995; Yaeger et al. 1998). Likewise, studies of laboratory animals have not observed developmental effects, except at levels of selenium administration that produce maternal toxicity (Bergman et al. 1990; Chiachun et al. 1991; Ferm et al. 1990; NTP 1996; Poulsen et al. 1989; Rosenfeld and Beath 1954; Schroeder and Mitchener 1971b; Thorlacius-Ussing

3. HEALTH EFFECTS

1990). In a teratology study of long-tailed macaques, no gross abnormalities or growth retardations were observed in fetuses from mothers administered doses that produced maternal toxicity.

No studies were located that compared pharmacokinetic properties of selenium in humans or animals of different ages. Selenium is transferred to fetuses via the placenta (Archimbaud et al. 1992; Choy et al. 1993; Hawkes et al. 1994; Jandial et al. 1976; Mahan and Kim 1996) and to infants via breast milk (Brätter and Negretti De Brätter 1996; Brätter et al. 1991b; Li et al. 1999; Michalke and Schramel 1998; Moser-Veillon et al. 1992; Rodríguez Rodríguez et al. 1999; Viitak et al. 1995; Yang 1989b). Studies of lactating women have shown a clear relationship between levels of selenium in the mother's diet and the concentration of selenium in her breast milk (Brätter et al. 1991b). Colostrum contains more than twice the selenium concentration of mature human milk, but the selenium content of mature milk changes little with advancing stages of lactation (Gathwala and Yadav 2002; Higashi et al. 1983; Mannan and Picciano 1987; Smith et al. 1982). No information was located regarding adverse effects in infants breast-fed by mothers in regions with high selenium diets.

A series of conditions are associated with oxygen therapy in neonates, including bronchopulmonary dysplasia, retinopathy of prematurity, necrotizing enterocolitis, patent ductus arteriosus, and neuronal injury in hypoxic ischemic encephalopathy (Gathwala and Yadav 2002). Because these effects might be caused at least in part by oxygen radicals, it has been suggested there is an "oxygen radical disease" in neonatology. This indicates that antioxidants may form an important modality of treatment in neonates, and because selenium is part of the antioxidant enzyme glutathione peroxidase, good selenium nutrition is important for antioxidant defense (Gathwala and Yadav 2002).

3.8 BIOMARKERS OF EXPOSURE AND EFFECT

Biomarkers are broadly defined as indicators signaling events in biologic systems or samples. They have been classified as markers of exposure, markers of effect, and markers of susceptibility (NAS/NRC 1989).

Due to a nascent understanding of the use and interpretation of biomarkers, implementation of biomarkers as tools of exposure in the general population is very limited. A biomarker of exposure is a xenobiotic substance or its metabolite(s) or the product of an interaction between a xenobiotic agent and some target molecule(s) or cell(s) that is measured within a compartment of an organism (NAS/NRC 1989). The preferred biomarkers of exposure are generally the substance itself or substance-specific metabolites in

3. HEALTH EFFECTS

readily obtainable body fluid(s), or excreta. However, several factors can confound the use and interpretation of biomarkers of exposure. The body burden of a substance may be the result of exposures from more than one source. The substance being measured may be a metabolite of another xenobiotic substance (e.g., high urinary levels of phenol can result from exposure to several different aromatic compounds). Depending on the properties of the substance (e.g., biologic half-life) and environmental conditions (e.g., duration and route of exposure), the substance and all of its metabolites may have left the body by the time samples can be taken. It may be difficult to identify individuals exposed to hazardous substances that are commonly found in body tissues and fluids (e.g., essential mineral nutrients such as copper, zinc, and selenium). Biomarkers of exposure to selenium are discussed in Section 3.8.1.

Biomarkers of effect are defined as any measurable biochemical, physiologic, or other alteration within an organism that, depending on magnitude, can be recognized as an established or potential health impairment or disease (NAS/NRC 1989). This definition encompasses biochemical or cellular signals of tissue dysfunction (e.g., increased liver enzyme activity or pathologic changes in female genital epithelial cells), as well as physiologic signs of dysfunction such as increased blood pressure or decreased lung capacity. Note that these markers are not often substance specific. They also may not be directly adverse, but can indicate potential health impairment (e.g., DNA adducts). Biomarkers of effects caused by selenium are discussed in Section 3.8.2.

A biomarker of susceptibility is an indicator of an inherent or acquired limitation of an organism's ability to respond to the challenge of exposure to a specific xenobiotic substance. It can be an intrinsic genetic or other characteristic or a preexisting disease that results in an increase in absorbed dose, a decrease in the biologically effective dose, or a target tissue response. If biomarkers of susceptibility exist, they are discussed in Section 3.10 "Populations That Are Unusually Susceptible".

3.8.1 Biomarkers Used to Identify or Quantify Exposure to Selenium

Biomarkers of exposure are available for high and low exposures to selenium. Selenium can be detected in the blood, feces, urine, hair, and nails of exposed individuals. Both selenium deficiency and excessive levels of selenium are associated with several disorders. For purposes of comparison, reported mean selenium concentrations in whole blood, blood constituents, urine, hair, nails, and the placenta for healthy individuals living in the United States and several other countries are listed in Table 3-7. Based on information collected from 1988 to 1994 in the third National Health and Nutrition Examination Survey (NHANES III), the serum concentration of selenium in the U.S. population has been estimated by sex and

3. HEALTH EFFECTS

age (DHHS 1997). The mean selenium serum concentration for all ages and both sexes was estimated to be 0.125 mg/L. Additional results from NHANES III are summarized in Chapter 6 (Section 6.5, Table 6-6). The analytical methods used to measure selenium (described in Chapter 7) have improved, and the more recent studies may be more reliable. The values for the Chinese populations studied by Yang et al. (1983, 1989b) were those reported for individuals living in the selenium "adequate" regions included in the study. "Normal" selenium concentrations in blood constituents and other tissues in people from some countries (e.g., New Zealand) are generally lower than those in people living in the United States. In general, urinary excretion rates of 20–200 µg selenium/day are not associated with either selenium deficiency or toxicity (Sanz Alaejos and Diaz Romero 1993).

In the United States and other developed countries, hair selenium concentrations are not necessarily indicative of dietary exposure to environmental selenium. Users of therapeutic dandruff shampoos containing selenium sulfide may have high levels of selenium in their hair because the externally deposited selenium adsorbs to hair (Alfthan 1985). However, due to minimal levels of dermal absorption of selenium from shampoo, blood and urine levels are not significantly affected by selenium-containing shampoos (Howe 1979). Toenail samples have also been used as biomarkers of selenium exposure (Hunter et al. 1990a). Selenium levels in toenails were measured in volunteers who ate bread containing selenium for 1 year (Longnecker et al. 1993). During this time period, selenium in the large toenail did not reach a steady state, while a steady state was reached in the other toenails. After conclusion of the 1-year exposure, levels of selenium continued to decline until they reached baseline levels in 2 years.

Below plasma and whole blood selenium concentrations of 0.10 mg selenium/L, a positive correlation has been reported between blood selenium levels and both erythrocyte and whole blood GPX activity (Duffield et al. 1999; Perona et al. 1977; Thomson 1977; Valentine et al. 1988). GPX is an enzyme that acts as a scavenger of peroxides and protects cells from oxidative damage. However, whole blood selenium levels \leq 0.10 mg selenium/L represent the lower end of the range of whole blood selenium concentrations reported by Allaway et al. (1968) for American males.

A correlation between blood selenium levels and GPX activity was not observed when plasma and whole blood selenium levels were above 0.10 mg selenium/L. Therefore, GPX activity is likely to be a biomarker for selenium deficiency but not for overexposure. Neve et al. (1988), on the other hand, found no relationship between erythrocyte or plasma GPX activity levels and plasma selenium levels in a group of Belgian subjects with plasma selenium levels between 0.087 and 0.13 mg selenium/L. However, platelet GPX activity levels did correlate with plasma selenium levels within this range (Neve et al. 1988).

3. HEALTH EFFECTS

Valentine et al. (1980) measured the level of selenium in whole blood, urine, and hair of 33 residents from a Mexican village who consumed drinking water contaminated with selenium (0.026–1.8 mg selenium/L) from a uranium mill tailing pond. Blood levels ranging from 0.133 to 0.248 mg selenium/L, urine excretion rates ranging from 14.4 to 337.5 µg selenium/day, and hair selenium levels ranging from 0.02 to 1.98 µg selenium/g were not correlated with GPX activity. In examining the relationship between selenium and GPX activity, selenium-dependent GPX activity must be distinguished from nonselenium-dependent GPX activity (Edwards and Blackburn 1986).

Selenoprotein P, which contains 10 selenocysteines, is the principal selenoprotein found in plasma (Sunde 1990). Selenoprotein P in plasma also does not continue to increase with increasing selenium and has been suggested as an alternative to GPX as a biomarker for selenium status (Duffield et al. 1999; Huang et al. 1995). The function of selenoprotein P has still not been determined.

Field studies have used primarily blood or urine levels to indicate the degree of selenium exposure. Valentine et al. (1978) found a significant correlation between selenium levels in well water used for drinking and urine selenium excretion measured for 35 residents in a New Mexico community. However, no correlation was found between selenium levels in well water and the blood selenium levels of the 35 residents (Valentine et al. 1978). The correlation coefficients between the log of urine-selenium excretion (µg selenium/day) and the log of blood-selenium (mg selenium/L) with the log of the well water selenium concentration (mg selenium/L) were 0.57 ($p < 0.01$) and 0.14 ($p > 0.05$), respectively. The correlation coefficient between the log of hair selenium concentration (µg selenium/g) and the log of the well water selenium levels (mg selenium/L) was 0.45 ($p < 0.01$).

Methylation is a detoxification pathway for selenium, and the extent of methylation is dose-dependent. Monomethylated selenium is excreted in the urine at deficient, normal, and low-toxic levels of selenium, and excretion of trimethylated selenium increases at toxic doses (Kobayashi et al. 2002). The main monomethylated form of selenium has been identified as a selenosugar (1β-methylselenol-*N*-acetyl-D-galactosamine). The dose-dependent nature of the metabolism indicates that urinary monomethylated (selenosugar) and trimethylated selenium could be used as indicators of selenium exposure that increase within the required to low-toxic range and with a distinct toxic dose, respectively (Kobayashi et al. 2002).

Clinical symptoms have been associated with excessive blood, urine, and hair levels of selenium in exposed patients. Glover (1967) examined workers in a selenium rectifier factory and found that selenium levels in urine from workers exposed to selenium (annual averages from 1954 and 1958 range

3. HEALTH EFFECTS

from 0.076 to 0.109 mg selenium/L urine) were higher than the average urine selenium levels of preemployment applicants (average, 0.034 mg selenium/L urine; range, 0–0.15 mg selenium/L). Garlic breath, skin rashes, indigestion, lassitude, and irritability were noted, but no increase in mortality among exposed workers was detected. Smith and Westfall (1937) examined urine selenium levels in rural populations in Wyoming, South Dakota, and Nebraska and reported evidence of skin discoloration and lesions, tooth decay, diseased nails, gastrointestinal disturbances, and arthritis in individuals with urine selenium levels of 0.2–1.98 mg selenium/L; however, the authors did not find a significant correlation between clinical signs and the level of selenium in the urine. Longnecker et al. (1991) examined ranchers in the same area of the United States where selenosis of livestock had been observed. No clinical effects were observed with concentrations up to 2.2 mg/L in urine. Yang et al. (1983, 1989a, 1989b) measured mean blood, urine, and hair selenium levels of 3.2 mg selenium/L, 2.68 mg selenium/L, and 32.2 µg selenium/g, respectively, in a high selenium area where chronic selenosis was common in China. The clinical signs of selenium intoxication included loss of hair and nails, skin lesions, tooth decay, and nervous system disorders. In another area of China with high environmental levels of selenium but no signs of chronic selenosis in the population, blood selenium levels averaged 0.44 mg selenium/L (with a range from 0.35 to 0.58 mg selenium/L).

At blood levels of 0.06–0.20 mg selenium/L, Deguchi (1985) found selenium to be positively correlated with grasping power and blood pressure in normal men and women and with hematocrit and hemoglobin concentrations in normal women. Similar correlations were not found in subjects with proteinuria or hypertension. In addition, Gebre-Medhin et al. (1988) found that in healthy children, serum selenium levels of 0.055–0.082 mg selenium/L were positively correlated with serum cholesterol, serum triglycerides, low and very low density lipoproteins, and apolipoproteins. Similar correlations were not found in diabetic children, who have slightly elevated serum selenium levels.

Biomarkers of Deficiency. Two endemic diseases, Keshan disease and Kashin-Beck disease, have been reported in selenium-deficient populations in China in which mean hair, blood, and urine selenium levels are low (Yang et al. 1988). Acute Keshan disease, manifested as nausea, vomiting of yellowish fluid, and necrosis of the myocardium, has been found in a population with an average whole blood selenium concentration of 0.018 mg selenium/L, an average urinary concentration of 0.007 mg selenium/L, and an average hair selenium concentration of 0.123 µg/g (Yang et al. 1988). Kashin-Beck disease, which causes atrophy, degeneration, and necrosis of cartilage tissue, was observed in selenium-deficient areas in China, in which the average selenium concentration in hair ranged from 0.077 to 0.165 µg selenium/g and blood selenium concentrations averaged approximately 0.02 mg selenium/L. In nonaffected areas in

3. HEALTH EFFECTS

China, the selenium content is $>0.2 \mu\text{g}$ selenium/g in hair and $>0.06 \text{ mg}$ selenium/L in blood (Yang et al. 1988). Although the association between selenium deficiency and Kashin-Beck disease is unclear, selenium-deficiency diseases are unlikely to occur in persons in the United States. If selenium is not added to parenteral nutrition solutions, persons on long-term total parenteral nutrition are at risk for developing selenium deficiency symptoms which include cardiomyopathies, muscle pain, and weakness (Thomson 1991).

There is also some evidence that low serum selenium levels are associated with increased cancer risk, but this is not conclusive (Hojo 1981a; Willett et al. 1983). Salonen et al. (1984) concluded that an increased risk of cancer (a combination of gastrointestinal, respiratory, urogenital, hematologic, dermal, and skeletal cancers) in humans in Finland is associated with serum selenium levels of 0.045 mg selenium/L and below. Virtamo et al. (1987) found that cancer patients in Finland, including individuals with gastrointestinal, respiratory, skin, skeletal, urogenital, and hematological cancers, had slightly but not significantly lower serum selenium levels (mean and standard error of $0.0539 \pm 0.0015 \text{ mg}$ selenium/L) compared with noncancer patients ($0.0553 \pm 0.0005 \text{ mg}$ selenium/L). However, serum selenium is generally an indicator only of very recent selenium status. As such, serum selenium may indicate an effect of cancer (malabsorption or anorexia) rather than a cause (Lockitch 1989; van't Veer et al. 1990).

A deficiency of selenium is also associated with cardiomyopathy (Johnson et al. 1981; Oster et al. 1983). Salonen et al. (1982) noted a statistically significant association between serum selenium concentrations of less than 0.045 mg selenium/L and the adjusted relative risk of coronary death, cardiovascular death, and myocardial infarction. Hojo (1981a) noted that patients with epilepsy had significantly lower urinary selenium levels than controls.

3.8.2 Biomarkers Used to Characterize Effects Caused by Selenium

Specific biomarkers were not found for effects of excess selenium, indicating that better markers of effects are needed at high levels of exposure. Garlic breath is a marker of over-exposure to selenium compounds. However, as other metals that are methylated (e.g., arsenic) also result in garlic odor of the breath, this effect is not a unique marker of selenium over-exposure. Hair and nail effects may be the most frequent effects of overexposure to selenium. Hair becomes dry and brittle and breaks off at the scalp. Nails are also brittle and have white spots and longitudinal streaks, and break off easily (Lockitch

3. HEALTH EFFECTS

1989). Although these effects may not be specific to selenium, if they are observed, a determination of selenium status may be useful.

Yang et al. (1989b) used increased prothrombin time (increased clotting time), a measure of hepatic damage, as a biomarker for selenium but their interpretation of their observations may be unwarranted. The difference they saw in affected humans was very small (1 second); prothrombin time has not been previously demonstrated to correlate with symptoms of selenosis nor used to detect selenosis; and since the test has not been widely used, the results reported for the small number of affected individuals may be within the range of normal values for the general population or a subpopulation (IRIS 2003).

In humans and in animal studies, high concentrations of selenium have been demonstrated to cause neurological effects. Biomarkers of effect for the neurological system have been reviewed by ATSDR (OTA 1990).

3.9 INTERACTIONS WITH OTHER CHEMICALS

A wide variety of interactions of selenium with essential and nonessential elements, vitamins, xenobiotics, and sulfur-containing amino acids have been demonstrated in numerous studies. Selenium has been reported to reduce the toxicity of many metals including mercury, cadmium, lead, silver, and to some extent, copper (Frost 1972; Levander 1982). Most forms of selenium and arsenic interact to reduce the toxicity of both elements (Levander 1977). Because of selenium's role in the antioxidant glutathione peroxidase enzymes, selenium also reduces the toxicity of metals in vitamin E-deficient animals (Diplock et al. 1967).

The interactions of selenium with other elements and compounds are complex and not well understood (Naganuma et al. 1983; NAS 1976a). The degree to which selenium is toxic, is taken up by tissues, or is excreted can be influenced by these interactions. Some of the major interactions of selenium compounds with other elements and compounds are described below.

Arsenic. In general, arsenic antagonizes selenium toxicity (Levander 1977). This effect extends to selenium in sodium selenite and selenate, seleniferous wheat, selenocystine, and selenomethionine (Levander 1977). However, a very pronounced synergistic toxicity exists between arsenic and two methylated selenium metabolites, trimethylselenonium ion and dimethyl selenide (Obermeyer et al.

3. HEALTH EFFECTS

1971). One of the more striking demonstrations is the antagonism of arsenic-induced terata in rodents by concomitant selenium exposure (Holmberg and Ferm 1969), and pretreatment of mice with sodium selenite reduced the clastogenic effects of a subsequent dose of sodium arsenite (Biswas et al. 1999b). Moxon et al. (1945) found that arsenic could reduce selenium toxicity when compounds of both elements were injected subcutaneously, thereby indicating that arsenic did more than interfere with the gastrointestinal absorption of selenium. Kamstra and Bonhorst (1953) found that arsenic reduced the excretion of volatile selenium compounds in expired air following the injection of compounds of both elements into rats at acutely toxic levels. Levander and Baumann (1966a) found that the amount of selenium retained in the liver decreased and the amount of selenium appearing in the gastrointestinal tract increased as the dose of administered arsenic was increased. Experiments with rats and guinea pigs with cannulated bile ducts confirmed that arsenic increased the biliary excretion of selenium and that selenium increased the biliary excretion of arsenic (Levander and Baumann 1966b). It has recently been suggested that the mutual reduction in toxicity of arsenic and selenium administered together is due to the formation of an arsenic-selenium compound, seleno-bis(S-glutathionyl)arsinium (Gailer et al. 2000b). This compound was isolated from the bile of rabbits injected with selenium and arsenic and identified by X-ray spectroscopy.

Cadmium. Selenium can antagonize the nephrotoxic and hepatotoxic effects of cadmium in rats (Flora et al. 1982; Lindh et al. 1996; Nehru and Bansal 1996; Stajn et al. 1997), the inflammation, atrophy, and necrosis induced by cadmium in testes of rats (Jones et al. 1997; Mason and Young 1967; Ohta and Imamiya 1986; Wlodarczyk et al. 1995; Yiin et al. 1999), and the cardiotoxicity of cadmium in rats (Jamall et al. 1989). The protective effects are thought to occur as a result of the formation of a selenium-cadmium complex of high molecular weight (Chen et al. 1975; Jamall et al. 1989; Jamba et al. 1997; Ohta and Imamiya 1986).

Fluoride. Fluoride ion may interact with selenium; however, the degree and types of interaction depend upon the chemical form of selenium (i.e., organic or inorganic) and the dose. Moxon and DuBois (1939) reported that fluoride increased the toxicity of selenium in rats at 5 mg fluoride/L in the drinking water of young rats fed a diet containing 11 ppm selenium (0.55 mg selenium/kg/day) as seleniferous wheat. Selenium decreased growth and increased mortality in rats drinking fluoridated water compared to rats drinking deionized water. These results were disputed by Hadjimarkos (1969a) who administered 3 mg selenium/L as sodium selenite (0.15 mg selenium/kg/day) either with or without 50 mg fluoride/L as sodium fluoride in the drinking water of rats. The growth and mortality data indicated that the combined administration of selenium and fluoride under the conditions used did not increase selenium toxicity.

3. HEALTH EFFECTS

However, the amount of administered fluoride was significantly higher and the amount of administered selenium was significantly lower in the Hadjimarkos (1969a) study than the amounts administered by Moxon and DuBois (1939). No additional studies were located that reexamined the possible interaction between fluoride and selenium.

Iodine. Selenium and iodine interact to affect thyroid function. There are at least two aspects to this interaction. First, selenium is an important component of the deiodinase enzymes, including iodothyronine 5'-deiodinases, which convert the prohormone thyroxine (T_4) to the active circulating form, triiodothyronine (T_3) (Delange 2000; Köhrle 1994; St Germain and Galton 1997). Second, selenium is also a component of GPX, the main enzyme responsible for protecting thyroid cells against oxidative damage. Hydrogen peroxide (H_2O_2) is produced in the thyroid during the conversion of T_4 to T_3 and is detoxified by GPX. An apparent consequence of interaction between iodine and selenium has been observed in human populations deficient in iodine. In some iodine-deficient geographic regions, a reversible hypothyroidism with goiter formation (myxedematous cretinism) is observed (Goyens et al. 1987; Vanderpas et al. 1990). In other iodine-deficient areas, hypothyroidism is accompanied by thyroid cell necrosis. The thyroid cell necrosis appears to result in populations that are deficient in both iodine and selenium (Contempré et al. 1991a, 1992, 1993, 1995; Köhrle 1994). Selenium supplementation of individuals deficient in both iodine and selenium produces a further decrease in thyroid function, but if selenium supplementation is preceded by normalization of iodine levels, then normal thyroid function is restored (Contempré et al. 1991, 1992). Selenium supplementation also affects thyroid hormone levels in humans with no iodine deficiency; these effects include decreases in serum T_3 and T_4 levels and increases in serum TSH levels, suggesting suppression of thyroid hormone production (Brätter and Negretti De Brätter 1996; Duffield et al. 1999; Hagmar et al. 1998; Hawkes and Turek 2001). The necrotizing effect of iodine on thyroid cells was greater in selenium-deficient rats than in selenium-supplemented rats (Contempré et al. 1993). Other studies in rats showed that selenium deficiency causes decreased metabolic clearance of iodothyronines and decreased extrathyroidal production of T_3 , as a result of decreased iodothyronine deiodinase activity, which can be restored to normal by selenium repletion (Arthur and Beckett 1989, 1994; Behne and Kyriakopolous 1993). The effects observed in iodine and selenium deficient humans and animals is consistent with a proposed mechanism in which (1) iodine deficiency results in hyperstimulation of the thyroid by TSH and consequently in increased production of H_2O_2 within the cells, (2) selenium deficiency results in GPX deficit and consequently in accumulation of H_2O_2 , and (3) induction of thyroid cell necrosis and fibrosis from the excess H_2O_2 that cannot be detoxified due the lack of GPX (Contempré et al. 1995; Delange 2000; Köhrle 1994). The available data suggest that iodine supplements could cause adverse effects in selenium-deficient individuals.

3. HEALTH EFFECTS

Mercury. Simultaneous administration of mercury and selenium in equimolar doses to animals resulted in decreased toxicity of both elements in acute and chronic studies with inorganic and organic mercury and with either inorganic or organic selenium compounds, although inorganic forms of selenium appear to be more effective than organic forms (Chang 1983; Rao et al. 1998; Skerfving 1978). Selenium protects against the acute nephrotoxicity of the mercuric ion and methylmercuric ion in rats (Ganter et al. 1972; Hansen 1988; Magos et al. 1987; Parizek and Ostadalova 1967) and possibly against acute neurotoxicity of the methylmercuric ion in rats (Ohi et al. 1980). The protective effect of selenium has been associated with a higher whole body retention of mercury rather than with increased mercury excretion (Hansen 1988; Magos et al. 1987). Selenium has been shown to inhibit biliary excretion of methyl mercury in rats (Urano et al. 1997), while mercury exposure reduces urinary selenium excretion in humans (Ellingsen et al. 1995). Although the mechanism of the interaction has not yet been elucidated, selenium and mercury appear to form a metabolically inert compound by reaction with GSH (Gailer et al. 2000b). Further support for the role of this compound comes from the observation that selenium-treated animals can remain unaffected despite an accumulation of mercury in tissues to levels that are otherwise associated with toxicity (Skerfving 1978). Additional support comes from the 1:1 ratio of selenium and mercury found in the livers of marine mammals and in the bodies of experimental animals injected with mercury and selenium, regardless of the ratio of the administered doses (Hansen 1988).

Although the fetotoxicity of methylmercuric chloride has been enhanced in selenium-deficient mice (Nishikido et al. 1987), additional selenium administration does not appear to protect against teratogenic effects (i.e., cleft palate) of methylmercuric chloride in mice (Lee et al. 1979). High doses of selenium administered as selenite for 30 days prior to gestation and through gestation day 18 to mice fed a diet containing high doses of methylmercuric chloride increased the incidence of cleft palate (Nobunaga et al. 1979). Concurrent treatment of pregnant or lactating mice receiving nontoxic doses of methyl mercury in drinking water with selenomethionine increased the deposition of mercury in the offspring (Nielsen and Andersen 1995).

Methionine and Vitamin E. Combinations of methionine and vitamin E have been found to be antagonistic to selenium toxicity. In one study, selenium concentrations in the liver and kidneys of rats fed selenium (sodium selenate)-containing diets with methionine and vitamin E were less than the concentrations found in the livers and kidneys of rats fed selenium with either methionine or vitamin E alone (Levander and Morris 1970). The results are compatible with the hypothesis that methionine detoxifies selenium by forming methylated derivatives of selenium that are eliminated in the urine and in

3. HEALTH EFFECTS

expired air (see Section 3.4.4) (Stadtman 1977, 1980, 1983, 1987, 1990). As discussed in Section 3.11, methionine administered as an antidote for acute selenium toxicity in rats was ineffective (Lombeck et al. 1987).

Silver. Selenium has been shown to be protective against the hepatotoxic effects of silver in vitamin E-deficient rats. A 0.15% solution of silver acetate in the drinking water of rats produced necrotic degeneration of the liver and high mortality. Dietary selenium supplementation at 1 mg selenium/kg food resulted in a significant reduction in the toxic effects of silver (Diplock et al. 1967). One report indicates a nontoxic dose of silver acetate in rats minimizes effects of acute selenium toxicity. However, the body burden of selenium in several organs increased with treatment with silver acetate. It is postulated that this antagonistic effect may be due to the formation and disposition of silver selenides, which are relatively insoluble and nontoxic (Eybl et al. 1992).

Sulfate. Sulfate appears to reduce the growth inhibition that results from dietary exposure of rats to high levels of selenite or selenate (Halverson and Monty 1960). Sulfate does not appear to be protective against selenium-induced liver damage (Halverson and Monty 1960).

Antagonistic interactions with several additional metals including antimony, germanium, and bismuth have been reported (Paul et al. 1989). Complex interactions of selenium with other metals, vitamins, and nutrients usually lead to a reduced toxicity of selenium and/or a reduced toxicity of the interacting substance. However, vitamin C (ascorbic acid) may increase the absorption and toxic effects of selenium in humans (HSDB 2001; Lombeck et al. 1987; Mack 1990; Martin et al. 1989a, 1989b). The relevance of these interactions to selenium exposure of the general public is unknown. Many review articles are available concerning the interactions of selenium and other chemicals, including those by Combs, Jr., and Combs (1987), Hansen (1988), Levander (1972), Magos and Webb (1980), Naganuma et al. (1983), and Whanger (1981).

3.10 POPULATIONS THAT ARE UNUSUALLY SUSCEPTIBLE

A susceptible population will exhibit a different or enhanced response to selenium than will most persons exposed to the same level of selenium in the environment. Reasons may include genetic makeup, age, health and nutritional status, and exposure to other toxic substances (e.g., cigarette smoke). These parameters result in reduced detoxification or excretion of selenium, or compromised function of organs

3. HEALTH EFFECTS

affected by selenium. Populations who are at greater risk due to their unusually high exposure to selenium are discussed in Section 6.7, Populations With Potentially High Exposures.

Data concerning human subpopulations with unusual susceptibility to the toxic effects of selenium were not located. Epidemiologic studies have identified populations with very low or very high nutritional status, and these groups are expected to have very different responses to selenium exposures. Pregnant and nursing women are believed to require more selenium than the general public (NRC 1989).

It is possible that persons exposed to high fluoride levels in drinking water might be at greater risk of adverse health effects from exposure to excessive levels of selenium (Moxon and DuBois 1939; Yang et al. 1989a), but evidence on this point is equivocal (Hadjimarkos 1969a) and requires further study. Individuals with vitamin E-deficient diets might also be at greater risk of liver damage from exposure to excess selenium (Levander and Morris 1970). Based on studies of chemically induced diabetes in rats, selenium may change insulin needs (McNeil et al. 1991). Therefore, insulin-dependent diabetics may be more sensitive to adverse health effects due to selenium exposure than the general population.

Cretins or other individuals with iodine or thyroid deficiencies may be more sensitive to adverse health effects from selenium exposure (Contempré et al. 1991b, 1992). Iodine supplementation of these individuals without selenium supplementation may further exacerbate the effects. The elderly may be less susceptible to the negative effects of selenium and more prone to selenium deficiencies. A number of researchers have reported lower absorption of selenium and lower selenium tissue concentrations in the elderly compared to younger adults (Martin et al. 1991; Morisi et al. 1989).

Populations living in the western United States in areas eating produce grown in highly seleniferous soils could be at greater risk of adverse health effects from additional environmental exposure to selenium if their selenium nutritional status is already high (see Section 6.6).

3.11 METHODS FOR REDUCING TOXIC EFFECTS

This section will describe clinical practice and research concerning methods for reducing toxic effects of exposure to selenium. However, because some of the treatments discussed may be experimental and unproven, this section should not be used as a guide for treatment of exposures to selenium. When specific exposures have occurred, poison control centers and medical toxicologists should be consulted

3. HEALTH EFFECTS

for medical advice. The following texts provide specific information about treatment following exposures to selenium:

Nadig RJ. 1994. Cadmium and other metals and metalloids. In: Goldfrank LR, Weisman RS, Flomenbaum N, et al. eds. Goldfrank's toxicological emergencies. 6th ed. Norwalk, CT: Appleton and Lange, 1342-1343.

Mofenson HC, and Caraccio TR. 1998. Toxicity of household products. In: Viccellio P, ed. Emergency toxicology. 2nd ed. Philadelphia, PA: Lippincott-Raven, 519.

3.11.1 Reducing Peak Absorption Following Exposure

No specific recommendations have been reported for reducing absorption following acute high-dose exposure to selenium or selenium compounds via inhalation or dermal exposure (Gosselin et al. 1984; HSDB 2001). There have been very few reported cases of overexposure via inhalation in industrial settings but some have resulted in toxic effects (Lockitch 1989). General procedures suggested for reducing absorption following accidental industrial exposure include moving the exposed person into fresh air, removing contaminated clothing and shoes, and flushing exposed skin or eyes with running water (HSDB 2001).

Oral exposures to toxic quantities of selenious acid, sodium selenate, and selenium dioxide have been reported (Lockitch 1989). In general, only supportive treatment has been recommended (HSDB 2001; Mack 1990). In some cases, gastric lavage and induction of vomiting by use of emetics have been reported to be useful in reducing absorption, but because selenious acid (in gun bluing, pH 1) is caustic, both procedures could result in additional damage by this compound (Lombeck et al. 1987; Mack 1990). The possibility of a sudden onset of shock, seizures, severe hypotension, and cardiorespiratory arrest has been used to argue against emesis (Mack 1990). It has also been suggested that oils and alcohol are to be avoided in treatment of ingested selenium sulfide because these agents may increase absorption (Gosselin et al. 1984).

3.11.2 Reducing Body Burden

In acute exposure situations, selenium compounds are rapidly absorbed and widely distributed throughout many organ systems following inhalation or ingestion (see Section 3.4.2). Extensive parenteral fluid administration has been used to force the urinary excretion of selenium (Lombeck et al. 1987). Chelating

3. HEALTH EFFECTS

agents have not been effective in experiments, and both calcium disodium ethylene diamine tetraacetate (EDTA) and dimercaprol (British Anti-Lewisite, BAL) may increase the toxic effects of selenium (Lombeck et al. 1987; Mack 1990; Paul et al. 1989). Although vitamin C (ascorbic acid) is used to reduce the body burdens of other metals, it may also increase the absorption and toxic effects of selenium in humans (HSDB 2001; Lombeck et al. 1987; Mack 1990; Martin et al. 1989a, 1989b). Bromobenzene has been reported to increase the urinary excretion of selenium, but because bromobenzene is also a hepatic toxin, its use is dangerous (Gosselin et al. 1984; HSDB 2001).

3.11.3 Interfering with the Mechanism of Action for Toxic Effects

The exact molecular mechanism of toxic action by selenium and selenium compounds is not known. One theory is that at a biochemical level, selenium inactivates sulfhydryl enzymes leading to depression of cellular oxidative processes (Lombeck et al. 1987; Mack 1990; Shamberger 1981). No information was located on established therapies designed to interfere with this possible mechanism of action of selenium. Because selenomethionine is known to randomly insert into proteins, rats were treated with methionine after acute selenosis had developed, but no effect was observed (Lombeck et al. 1987). However, pretreating rats with dietary methionine and vitamin E reduced the toxicity of dietary selenium as measured by decreased liver damage, reduced body weight gain, and decreased liver and kidney concentrations of selenium compared to those in rats that had not received supplements (Levander and Morris 1970). Inorganic sulfate fed simultaneously with selenite or selenate in the diet protected rats from the toxicity of selenium as measured by body weight gain; however, sulfate did not protect against liver necrosis caused by selenium (Halverson et al. 1962). It would, therefore, seem plausible that another nontoxic sulfur-containing chemical could be found to be effective against acute selenium toxicity.

The search for an agent that both reduces the acute toxicity of selenium and increases the excretion of the selenium compound formed has proved difficult (Paul et al. 1989). In some experimental cases, other metals have been shown to mitigate the toxicity of selenium, possibly by forming metal selenides with low solubility and toxicity (see Section 3.9). Several metal-containing compounds were tested for efficacy in reducing toxic effects and increasing elimination of selenium from sodium selenate injected into rats. Germanium citrate is nontoxic and was found to be effective both at reducing toxic effects and increasing the rate of selenium elimination. However, the germanium compound, bis-carboxyethyl germanium sesquioxide, had no positive effect on toxicity or distribution to organs but did increase the amount of selenium excreted in the urine (Paul et al. 1989). In mice, pretreatment with a nontoxic dose of

3. HEALTH EFFECTS

silver acetate was shown to reduce the toxic effects of sodium selenite. However, this treatment increased the whole body burden of selenium, and the concentrations in several organs were raised compared to those in the controls injected with sodium selenite only (Eybl et al. 1992). Arsenic was proposed as a possible prophylactic against selenium poisoning in workers, based on counteraction of selenium toxicity in pigs exposed to sodium arsenate (Amor and Pringle 1945).

3.12 ADEQUACY OF THE DATABASE

Section 104(i)(5) of CERCLA, as amended, directs the Administrator of ATSDR (in consultation with the Administrator of EPA and agencies and programs of the Public Health Service) to assess whether adequate information on the health effects of selenium is available. Where adequate information is not available, ATSDR, in conjunction with the National Toxicology Program (NTP), is required to assure the initiation of a program of research designed to determine the health effects (and techniques for developing methods to determine such health effects) of selenium.

The following categories of possible data needs have been identified by a joint team of scientists from ATSDR, NTP, and EPA. They are defined as substance-specific informational needs that if met would reduce the uncertainties of human health assessment. This definition should not be interpreted to mean that all data needs discussed in this section must be filled. In the future, the identified data needs will be evaluated and prioritized, and a substance-specific research agenda will be proposed.

3.12.1 Existing Information on Health Effects of Selenium

The existing data on health effects of inhalation, oral, and dermal exposure of humans and animals to selenium are summarized in Figure 3-10. The purpose of this figure is to illustrate the existing information concerning the health effects of selenium. Each dot in the figure indicates that one or more studies provide information associated with that particular effect. The dot does not necessarily imply anything about the quality of the study or studies, nor should missing information in this figure be interpreted as a “data need”. A data need, as defined in ATSDR’s *Decision Guide for Identifying Substance-Specific Data Needs Related to Toxicological Profiles* (Agency for Toxic Substances and Disease Registry 1989), is substance-specific information necessary to conduct comprehensive public health assessments. Generally, ATSDR defines a data gap more broadly as any substance-specific information missing from the scientific literature.

3. HEALTH EFFECTS

Figure 3-10. Existing Information on Health Effects of Selenium

	Systemic									
	Death	Acute	Intermediate	Chronic	Immunologic/Lymphoretic	Neurologic	Reproductive	Developmental	Genotoxic	Cancer
Inhalation		●				●				●
Oral	●	●		●	●	●	●			●
Dermal		●								

Human

	Systemic									
	Death	Acute	Intermediate	Chronic	Immunologic/Lymphoretic	Neurologic	Reproductive	Developmental	Genotoxic	Cancer
Inhalation	●	●								
Oral	●	●	●	●	●	●	●	●	●	●
Dermal					●					●

Animal

● Existing Studies

3. HEALTH EFFECTS

As seen in Figure 3-10, very little quantitative information is available regarding the health effects in humans exposed to selenium compounds via inhalation. The only quantitative inhalation studies in humans that relate selenium exposure levels or selenium body levels to health effects following inhalation exposure are epidemiological cancer studies. Fatalities following inhalation exposure to selenium compounds have not been reported. Despite the large number of cases of reported inhalation exposures in occupational settings, characterization of exposure concentrations and the selenium compounds present in the air are generally lacking. It is therefore not possible to link the degree and types of symptoms reported in workers to selenium exposure levels. There have been no reports of immunological, developmental, reproductive, or genetic effects in humans resulting from inhalation exposure to selenium compounds. Complaints of dizziness and fatigue have accompanied occupational inhalation exposures, but characterization of the exposure levels required to produce neurological symptoms is lacking.

Most of the information concerning the health effects in humans following exposure to selenium and selenium compounds is for the oral exposure route. However, exposure levels associated with the few documented fatalities resulting from accidental or suicidal poisoning with selenium compounds are lacking, as are exposure levels for other nonfatal poisonings by ingestion. A series of epidemiological studies in China have provided the only data about chronic exposure levels to excess dietary selenium that resulted in adverse effects on skin, nails, and hair and in possible neurological effects.

Older reports from the western United States described similar symptomology in the 1930s, but did not characterize daily selenium intake. More recent reports show no clinical symptoms in the same area. The possible inverse relationship between dietary selenium intake and the risk of various types of cancer has been examined in numerous epidemiological studies in the United States and other countries.

Concern for the dermal route of exposure to selenium compounds as a cause of adverse health effects in humans is extremely low except for the acid forms, which owe their dermal effects to their acidity more than to their selenium content. Selenium sulfide, an ingredient in some antidandruff shampoos, does not appear to be absorbed through the skin. Ingestion of large amounts of the compound, however, would be of concern because selenium sulfide has been shown to be carcinogenic in rats and mice following oral exposure.

Data are available for acute inhalation exposures for a few of the volatile selenium compounds that have resulted in the death of animals. These exposures also produced signs of central nervous system toxicity,

3. HEALTH EFFECTS

lung injury, and possible damage to heart and liver. No studies were located concerning health effects in animals following intermediate or chronic inhalation exposures to volatile selenium compounds or selenium dust.

In animals, the focus on the oral toxicity of selenium has taken two routes, one in laboratory animals and the other in studies of selenium toxicity to livestock. In laboratory animals, attention has been directed toward the hepatotoxic properties of selenites, selenates, and selenium contained in grains following early reports that selenium produced hepatic carcinomas in rats. An intermediate-duration study has also shown that selenate and selenite can cause kidney effects in rats while mice are less sensitive to this effect of selenium compounds. In recent years, much of the research in laboratory animals using the oral route of administration of selenium compounds has been directed toward the anticarcinogenic properties of selenium compounds.

In livestock, concern for selenium toxicity and deficiency is high. In areas of the country with selenium-poor soils, dietary selenium supplementation for livestock has been necessary to prevent chronic selenium deficiency diseases. Dietary supplementation programs have resulted in cases of accidental poisonings from misuse of the selenium supplements (Hopper et al. 1985).

3.12.2 Identification of Data Needs

Acute-Duration Exposure. The primary target organ in humans following acute exposure to high concentrations of selenium by inhalation or oral routes is the lung, with cardiovascular, hepatic, and renal systems all affected (lesser systemic effects were observed in all other organ systems except the musculoskeletal system) (Carter 1966; Civil and McDonald 1978; Clinton 1947; Koppel et al. 1986; Wilson 1962). Two case reports of acute dermal exposure were also located; the results revealed effects on the skin and eyes (Middleton 1947; Pringle 1942). Additional epidemiological or occupational studies would be useful to further characterize the effects of acute exposure via all routes and to confirm the target organ data.

Studies regarding single inhalation or oral exposures of rats, guinea pigs, rabbits, and mice have provided information on lethal levels of exposure to selenium compounds (Cummins and Kimura 1971; Dudley and Miller 1941; Hall et al. 1951; Miller and Williams 1940; Olson 1986; Smyth et al. 1990). However, few levels at which sublethal effects first appear have been identified. Clinical observations and gross

3. HEALTH EFFECTS

necropsies have been performed, but no single-dose exposure study has included internal examination of the animals to identify dose-response data for sublethal systemic toxic effects. Such studies might provide information on the thresholds for systemic toxicity following single-dose exposure. Repeated inhalation exposure studies in animals are limited to a few days of exposure (Hall et al. 1951). Although the studies have demonstrated cumulative toxicity following repeated inhalation exposure to inorganic selenium compounds, effects other than lethality have been poorly characterized. Single-dose exposure studies have been conducted with selenium monosulfide in mice (target systems: respiratory and neurological) and selenium disulfide in rats (target organ not specified); however, the results have varied and there is uncertainty about which or how much of each of the compounds was administered. There were no effects in mice following acute dermal exposure. Additional dermal exposure studies in animals would be useful to confirm the effects found in humans. The data were insufficient for the derivation of acute oral and inhalation MRLs.

Intermediate-Duration Exposure. No human studies of intermediate inhalation exposure to selenium were located. Following oral exposure, one study in humans revealed endocrine effects in iodine-deficient individuals (Contempré et al. 1991a, 1992) and others revealed endocrine effects in individuals receiving sufficient levels of iodine (Duffield et al. 1999; Hawkes and Turek 2001). Results from one study in humans revealed dermal effects following intermediate dermal exposure (Pringle 1942). There were insufficient data to derive intermediate MRLs. Additional epidemiological or occupational studies would be useful in elucidating the potential target organs and effect levels.

No intermediate inhalation studies were located in animals. Intermediate-duration inhalation studies, in which selenium is administered as selenium dioxide, hydrogen selenide, or selenium dust, might help to identify air concentrations of these substances that produce sublethal effects not only on the respiratory system, but also on the hepatic, renal, hematological, and cardiovascular systems. As exposure to the selenoamino acids is via ingestion, inhalation studies of these compounds would not be necessary.

Intermediate-duration oral exposure studies have been performed with rats, pigs, mice, and monkeys at several dose levels using several selenium compounds (Baker et al. 1989; Behne et al. 1992; Bioulac-Sage et al. 1992; Chen et al. 1993; Cukierski et al. 1989; Das et al. 1989b; Eder et al. 1995; Halverson et al. 1966; Hasgawa et al. 1994; Hotz et al. 1997; Mahan and Magee 1991; Mihailovic et al. 1992; NTP 1980c, 1994; Palmer and Olson 1974; Panter et al. 1996). The major effects were hepatic, dermal, endocrine, and neurological. Additional studies are needed to confirm these data. No intermediate-duration dermal administration studies have been conducted with the environmental forms of inorganic

3. HEALTH EFFECTS

selenium likely to be of concern (e.g., sodium selenate and sodium selenite), although it is unlikely that these forms would be dermally absorbed to a significant degree. Dermal application of selenomethionine to the skin of mice did not result in any direct effects on the skin, or other signs of toxicity, although it was absorbed (Burke et al. 1992b). The organic compounds of selenium are usually not free in the environment but, rather, are contained in plant and animal material. Therefore, no further dermal studies would be useful.

Chronic-Duration Exposure and Cancer. Several occupational studies of chronic inhalation exposure to inorganic selenium compounds were located (Glover 1967; Holness et al. 1989; Kinnigkeit 1962). Effects reported in these studies were primarily respiratory, although cardiovascular, gastrointestinal, hematological, musculoskeletal, dermal, ocular, and neurological effects were also noted. Animal data are not available for inhalation exposures of chronic duration. Data in this area would be helpful to establish an animal model for respiratory effects of inorganic selenium compounds, since most human exposure has been occupational and to a variety of compounds. Neurological effects have been documented in animals after chronic oral exposure, but further study of neurological effects in animals after inhalation exposure is needed to provide a model for the effects observed after occupational exposure in humans. Following chronic oral exposure, the primary effects in humans were dermal, neurological, and endocrine (Brätter and Negretti De Brätter 1996; Clausen et al. 1989; Longnecker et al. 1991; Yang et al. 1983, 1989a, 1989b; Yang and Zhou 1994). An MRL has been derived for chronic oral exposure to selenium based on a NOAEL for dermal effects. One case report of chronic dermal exposure revealed dermal effects (Senff et al. 1988). Additional epidemiological or retrospective studies of chronic exposure would be helpful for confirming the existing data. Studies examining the role of nutrition in selenium toxicity would be especially useful.

Although the lung does not appear to be a target organ in animals after chronic oral exposure to selenium compounds, data have not been adequately reported (Harr et al. 1967; Henschler and Kerschner 1969; Schroeder and Mitchener 1972), and further studies might be useful to fully rule out these effects. Studies examining possible gastrointestinal and musculoskeletal effects in animals after chronic exposure to selenium or selenium compounds or to seleniferous grains might be helpful in determining the mechanisms of alkali disease whose symptoms have been observed in grazing livestock (Harr et al. 1967; Shamberger 1986). Hepatic and renal lesions following chronic selenium exposure have been adequately characterized. Investigations of systemic effects associated with chronic oral administration of selenium compounds, however, have been limited.

3. HEALTH EFFECTS

No studies were located regarding carcinogenic effects in animals after chronic inhalation exposure to selenium or selenium compounds. No further investigation is needed since humans have not been shown to have an increased risk of malignancy from selenium exposure. The majority of oral studies have provided information on the absence of carcinogenic effects in humans and animals (Beems 1986; Clark et al. 1996a, 1999; Coates et al. 1988; Duffield-Lillico et al. 2002; Harr et al. 1967; Menkes et al. 1986; Reid et al. 2002; Thompson and Becci 1979; Virtamo et al. 1987). However, earlier and less complete studies had suggested that selenium was carcinogenic following oral exposure of animals (Nelson et al. 1943; Schroeder and Mitchener 1971a; Volgarev and Tscherkas 1967). Chronic oral exposure studies conducted in mice and rats by gavage administration of a mixture of selenium monosulfide and selenium disulfide produced liver tumors in rats and lung tumors in female mice (NTP 1980c). The relative proportion of the two compounds was not clear, although physical evidence suggested that the dose solution was primarily selenium monosulfide. Further studies utilizing selenium sulfides might be useful in determining possible effects in humans.

Genotoxicity. Chromosomal aberrations and sister chromatid exchanges in lymphocytes were not increased in humans treated (oral or intramuscular injection) with sodium selenite (Norppa et al. 1980a). Compared to untreated controls, a significant increase in the number of micronuclei was observed in bone marrow cells of mice treated orally with selenite or selenate, and macaques treated orally with L-selenomethionine (Biswas et al. 1997, 1999a; Choy et al. 1989; Itoh and Shimada 1996; Rusov et al. 1996). A significant increase in the number of micronuclei in bone marrow cells was not observed in the offspring of macaques treated with L-selenomethionine on gestation days 20–50 (Choy et al. 1993).

Genotoxicity studies (*Salmonella*/microsome assays, sister chromatid exchange, and tests of unscheduled DNA synthesis and of chromosome aberrations in cultured mammalian cells) indicate that selenite, selenate, and selenide have both genotoxic and antigenotoxic effects (Biswas et al. 1997, 2000; Gairola and Chow 1982; Khalil 1994; Lu et al. 1995b; Schillaci et al. 1982; Ueda et al. 1997; van der Lelie et al. 1997). The underlying mechanisms responsible for the varying genotoxicity results remain to be elucidated.

Reproductive Toxicity. One study that measured the concentration of selenium in sperm samples indicated no correlation between selenium concentrations and sperm count or motility (Roy et al. 1990). No significant increase in spontaneous abortions was reported among women chronically exposed to drinking water containing 7–9 µg/L selenium (Vinceti et al. 2000a). This study is limited by a level of selenium in water that is not generally considered to be high, lack of data on selenium status, and

3. HEALTH EFFECTS

insufficient information on confounding variables. No other human studies were located. A few reproductive toxicity studies in animals (Chowdhury and Venkatakrishna-Bhatt 1983; Harr and Muth 1972; NTP 1996; Schroeder and Mitchener 1971b; Wahlstrom and Olson 1959b) indicate that oral exposure to excess sodium selenite can reduce female fertility, although male fertility appears not to be affected. Oral treatment of rats with sodium selenate or selenite has been shown to increase the number of abnormal sperm in males (El-Zarkouny et al. 1999; Kaur and Parshad 1994; NTP 1994), produce testicular hypertrophy (Turan et al. 1999a), and affect the estrous cycle (NTP 1994, 1996). Fertility was not examined in these studies. Selenium dioxide produced testicular degeneration following intraperitoneal administration to rats (Chowdhury and Venkatakrishna-Bhatt 1983). Disturbances in the menstrual cycle (anovulation, short luteal and follicular phases) were observed in monkeys treated orally with L-selenomethionine (Cukierski et al. 1989) and mice treated orally with sodium selenite (Nobunaga et al. 1979). Studies of both male and female reproductive toxicity of selenium following oral and inhalation exposure in rats and other mammals to selenium dioxide and other forms of selenium, both organic and inorganic, would be useful. Such studies could provide information regarding the reproductive effects of the various forms of selenium that might be encountered in occupational settings, at waste sites, and in the drinking water and food from highly seleniferous areas of the United States.

Developmental Toxicity. No developmental studies were found regarding inhalation or dermal exposure in humans or animals. Developmental studies using the oral route of administration indicate that excessive sodium selenate or sodium selenite intake can result in fetal toxicity and reduced growth in experimental mammals (Dinkel et al. 1963; Ferm et al. 1990; NTP 1996; Rosenfeld and Beath 1964; Wahlstrom and Olson 1959a), but generally only at doses that produce maternal toxicity. Developmental effects were not observed in macaque fetuses from mothers given toxic oral doses of L-selenomethionine during gestation (Tarantal et al. 1991). Intravenous injection of sodium selenite in mice did not indicate that the compound is teratogenic in rodents (Yonemoto et al. 1984). Intravenous injections of sodium selenate, D,L-selenomethionine, and D,L-selenocystine into neonatal rats indicated that some selenium compounds can contribute to the formation of one type of cataracts (Ostadalova and Babicky 1980). Cataracts were not observed in the offspring of macaques treated orally with L-selenomethionine during gestation (Tarantal et al. 1991). Additional developmental toxicity studies of selenium compounds in mammals do not seem to be necessary at this time.

Immunotoxicity. No studies were located regarding adverse immunological effects in humans following inhalation or oral exposure. One case report describes immunological effects following dermal exposure (Senff et al. 1988). Animal studies of possible adverse immunological effects from excessive

3. HEALTH EFFECTS

exposure to selenium compounds are limited (Dudley and Miller 1941; Glenn et al. 1964a; Hall et al. 1951; Smyth et al. 1990). One study (Koller et al. 1986) included a battery of immunological tests, some of which indicated beneficial effects of sodium selenite administration and others that indicated adverse effects. Additional immunotoxicity tests, including challenges of the immune system, might characterize the significance of the different immunological effects that have been observed following selenium administration.

Other than selenium sulfide, an ingredient in some antidandruff shampoos, selenium compounds have not been tested for sensitization. The potential for dermal contact by humans does exist, however, in occupational settings and to a lesser extent in soil at waste sites.

Neurotoxicity. Data from an epidemiological study of humans and from studies in livestock indicate that the central nervous system is an end point of concern following oral exposure to selenium compounds (Baker et al. 1989; Boylan et al. 1990; Cukierski et al. 1989; Harrison et al. 1983; Panter et al. 1996; Rosenfeld and Beath 1964; Stowe et al. 1992; Tsunoda et al. 2000; Yang et al. 1983). Chronic oral exposure studies of laboratory animals that focus on behavioral effects and histopathological changes in the central nervous system might provide useful dose-response information on central nervous system effects.

Epidemiological and Human Dosimetry Studies. A few human epidemiological studies have identified blood selenium levels indicative of adequate selenium status and indicative of selenium toxicity. However, there are large differences in selenium blood levels in populations from different parts of the world (e.g., China, New Zealand, and Finland) (Salonen et al. 1985; Yang et al. 1989a). For example, blood selenium levels in healthy New Zealand populations averaged 0.059 mg selenium/L (Rea et al. 1979), whereas blood selenium levels in healthy U.S. populations were much higher, averaging 0.206 mg selenium/L (Allaway et al. 1968). Extrapolation from the relationship between blood selenium levels and selenium toxicity in populations from one region of the world to populations in another region may not be appropriate. Studies examining the particular forms of selenium and the contribution of diet in determining individual and population selenium status would be useful. The selenium status of an individual will determine the magnitude of additional selenium intake that can be tolerated without resulting in adverse effects. Evidence for adverse effects on the endocrine system has also been found following intermediate and chronic oral exposure to elevated levels of dietary selenium in humans and animals (Brätter and Negretti De Brätter 1996; Behne et al. 1992; Eder et al. 1995; Hawkes and Turek 2001; Hotz et al. 1997). Studies of humans with high dietary intakes of selenium that monitored thyroid

3. HEALTH EFFECTS

hormone levels and iodine intake would be useful. Studies of humans taking selenium supplements would also help further identify the long-term effects of selenium status on human health.

Biomarkers of Exposure and Effect.

Exposure. Selenium exposure can be correlated with concentrations detected in human blood, blood components, urine, hair, and nails. Selenium concentrations found in these biomarkers in the general population can be found in Table 3-7. However, these markers vary greatly among different populations (Longnecker et al. 1991). Levels of plasma, erythrocyte and platelet GPX activity, as well as selenoprotein P may serve as better markers of selenium deficiency than selenium concentrations. Additional research into markers of selenium status in populations and how they may be used to estimate an additional selenium exposure that would be safe would be helpful.

Effect. There currently are no good preclinical indicators of selenium toxicity. Perhaps the earliest and most frequent symptoms of selenosis in humans are dry and brittle hair that breaks off, and brittle nails with white spots or streaks. Although these effects may not be specific to selenium, determination of selenium status could be useful if they are observed in a subject. Additional biomarkers of negative effects that could be detected before clinical signs of selenium toxicity would be helpful in identifying and preventing selenium poisoning.

Absorption, Distribution, Metabolism, and Excretion. The absorption of selenium has been investigated in humans following oral exposure and in animals following oral and inhalation exposures (Finley 1998; Glover 1970; Griffiths et al. 1976; Martin et al. 1989a; Medinsky et al. 1981a; Sánchez-Ocampo et al. 1996; Thomson et al. 1977). In humans, no quantitative data exist on either the extent or rate of absorption of selenium from the lung or the skin. Information that selenium is absorbed following inhalation is limited to occupational case studies in which larger quantities of selenium have been measured in the urine of workers occupationally exposed to selenium. In order to understand all possible routes for human overexposure to selenium, information concerning the dermal and inhalation absorption of selenium and its compounds in humans would be useful, even though potential exposures to selenium might be more likely to occur by the oral route for the general public.

The oral absorption of different physical and chemical forms of selenium (e.g., selenite, selenate, and selenomethionine as solids or in aqueous solution) has been investigated in humans (Griffiths et al. 1976; Martin et al. 1989a; Moser-Veillon et al. 1992; Robinson et al. 1978; Swanson et al. 1991; Thomson

3. HEALTH EFFECTS

1974; Thomson and Stewart 1974; Thomson et al. 1977) and in animals (Finley 1998; Furchner et al. 1975; Thomson and Stewart 1973; Vendeland et al. 1992; Whanger et al. 1976). Oral absorption of naturally occurring selenium and the effects of dietary levels on the absorption of exogenous selenium have also been investigated (Young et al. 1982). These studies have revealed that several selenium compounds appear to be readily absorbed from the gastrointestinal tract of humans and animals. It also appears that the degree of absorption in humans is independent of the exposure level, but that in some cases, absorption is greater when a selenium deficiency exists.

Distribution studies in humans and animals indicate that selenium is widely distributed in the body and is concentrated in the liver and kidney following oral, intravenous, or subcutaneous exposures (Cavalieri et al. 1966; Finley 1998; Heinrich and Kelsey 1955; Jereb et al. 1975; Kaneko et al. 1999; Mahan and Kim 1996; Razagui and Haswell 1997; Shiobara et al. 1998; Thomson and Stewart 1973). Studies of intravenous administration of selenomethionine have indicated that animals and humans concentrate this compound in the pancreas, but it is unlikely that this selenium compound will be encountered in large quantities in the environment except in animals and plants along with other organic selenium compounds. It would be useful to know if selenomethionine concentrates in the pancreas of humans following oral intake. Following oral exposure, the distribution of selenium across the placenta into the fetuses of rats, hamsters, dogs, and monkeys (Archimbaud et al. 1992; Choy et al. 1993; Hawkes et al. 1994; Mahan and Kim 1996; Parizek et al. 1971a; Willhite et al. 1990) and the transfer of selenium from milk to suckling offspring of rats, dogs, and monkeys (Archimbaud et al. 1992; Choy et al. 1993; Hawkes et al. 1994; Parizek et al. 1971a) have also been investigated. Selenium levels have been measured in human milk (Brätter and Negretti De Brätter 1996; Brätter et al. 1991b; Li et al. 1999; Michalke and Schramel 1998; Moser-Veillon et al. 1992; Rodríguez Rodríguez et al. 1999; Viitak et al. 1995; Yang 1989b), and the concentration of selenium in human milk has been shown to correlate with dietary intake (Brätter et al. 1991b). The uptake of selenium by erythrocytes and its subsequent metabolic alteration and ultimate binding to plasma proteins have been investigated (Sandholm 1973).

The metabolism of selenium is now fairly well understood. To become incorporated into selenium-specific proteins (e.g., glutathione peroxidase, thioredoxin reductase, iodothyronine 5'-deiodinase) through a cotranslational mechanism requires that selenium be in the form of selenide (Sunde 1990). All forms of selenium can be transformed to selenide, although the rates of transformation vary. For example, selenate is not converted to selenide as readily as selenite. The formation of selenide from selenocysteine requires a specific enzyme, selenocysteine β -lyase, which catalyzes the decomposition of selenocysteine to alanine and hydrogen selenide. Excess selenium can be methylated and exhaled or

3. HEALTH EFFECTS

excreted in the urine in both humans and animals. Further research is required to determine which selenium metabolites or intermediates lead to toxicity.

In humans and animals, intravenous and oral administration data indicate that the major route of selenium excretion is in the urine (Byard and Baumann 1967; Davidson-York et al. 1999; Finley 1998; Griffiths et al. 1976; Palmer et al. 1970; Patterson et al. 1989; Shiobara et al. 1998; Swanson et al. 1991). Excretion of selenium in feces constitutes a minor pathway immediately following exposure, but the amount excreted can be equal to that excreted in urine depending on the chemical form of selenium administered, the size of the dose, and the length of time since dosing. Both human and animal studies indicate that the extent of excretion by any one route is related to the administered dose and the frequency of administration (Finley 1998; Lathrop et al. 1972; McConnell and Roth 1966; Shiobara et al. 1998; Thomson and Stewart 1974). The extent of excretion of selenium compounds in the expired air has been investigated in animals, but no quantitative studies in humans for this route exist; however, it is believed to be a minor pathway especially at lower doses (McConnell and Roth 1966; Olson et al. 1963).

Comparative Toxicokinetics. The target organs and adverse health effects are generally similar across species. However, the liver appears to be the primary target organ for the oral toxicity of selenium in animals following intermediate and chronic exposure (Baker et al. 1989; Biolac-Sage et al. 1992; Fitzhugh et al. 1944; Halverson et al. 1970; Harr et al. 1967; Hasegawa et al. 1994; Kolodziejczyk et al. 2000; Nelson et al. 1943; Palmer and Olson 1974; Sayato et al. 1993; Schroeder and Mitchener 1972; Skowerski et al. 1997a; Turan et al. 1999a), whereas liver cirrhosis or dysfunction have not been found in reports of chronic selenosis in humans (Longnecker et al. 1991; Yang et al. 1989a). Different metabolites may help explain the cataract formation observed in neonatal rats and the teratogenic activity of selenium seen in birds but not in humans or other mammals (Tarantal et al. 1991). Toxicokinetic studies with some design similarities have been performed in humans and several animal species (Behne et al. 1991; Bopp et al. 1982; Cantor et al. 1975; Ganther 1979; Hawkes et al. 1992; Obermeyer et al. 1971; Palmer et al. 1970; Willhite et al. 1990, 1992). Comparative toxicokinetic studies, per se, have not been performed. PBPK models for selenium administered orally as selenite or selenomethionine have been developed for humans, but no animal models were located. Animal models for the oral route would be useful in assessing toxicokinetic similarities and differences between species.

Methods for Reducing Toxic Effects. Current methods for reducing toxic effects of selenium and selenium compounds after acute exposures are general supportive treatment methods based on those used for other toxic metals (HSDB 2001; Mack 1990). Because there is no suitable way to treat either acute or

3. HEALTH EFFECTS

chronic selenium poisoning, additional research aimed at decreasing absorption, speeding excretion, and reducing the body burden of selenium would be valuable.

Children's Susceptibility. Limited information is available on the toxicity of selenium in children, but the available information suggests that children may be less susceptible to toxic effects of selenium than adults and more susceptible to deficiency. Most data comes from children living in areas of chronic high dietary selenium intake (Yang et al. 1989a, 1989b). Additional research on age specific effects of selenium toxicity does not appear necessary at present.

Child health data needs relating to exposure are discussed in 6.8.1 Identification of Data Needs: Exposures of Children.

3.12.3 Ongoing Studies

The American Health Foundation is involved in on-going research to develop new organoselenium chemopreventive agents for cancer having an increased therapeutic ratio compared with some of the historical selenium compounds, such as selenite. Additional federally sponsored research that was reported in the CRIS/USDA (2002), CRISP (2002), and FEDRIP (2002) databases is shown in Table 3-8.

3. HEALTH EFFECTS

Table 3-8. On-going Studies on Selenium Health Effects

Investigator	Institute	Research area	Reference
Alberts, DS	University of Arizona	Phase III trials of chemopreventive agents on colon carcinogenesis	CRISP 2001
Aposhian, HV	Not Available	Detoxification of metals – <i>In vitro</i> and <i>in vivo</i> studies	CRISP 2002
Bar-Noy, S and Nhlbi, NIH	National Institutes of Health	Mammalian thioredoxin reductase	FEDRIP 2002
Beck, MA	University of North Carolina	The influence of nutrition on influenza virus infection	FEDRIP 2002
Bell, J	Not available	Effects of selected metal salts on the fidelity of DNA synthesis <i>in vitro</i>	CRISP 2002
Bennish, ML	National Institutes of Health	Micronutrients and enteric infection in African children	FEDRIP 2002
Beran, M	Vyzkumny Ustav Potravinarsky	Evaluation of combined supplementation with selenium and iodine on levels of selenium-dependent enzymes, thyroidal hormones and other biochemical parameters	CRIS/UDSA 2001
Berry, MJ	Brigham and Women's Hospital	Mechanism of selenoprotein synthesis in eukaryotes	CRISP 2001
Berry, MJ	Brigham and Women's Hospital	Selenoprotein P function and regulation of expression	CRISP 2002
Block, E	Roswell Park Memorial Institute	Identify selenium compounds from high-selenium garlic	CRISP 2001
Bosland, MC	New York University School of Medicine	Preclinical prostate cancer chemoprevention studies	CRISP 2001
Burk, RF	Vanderbilt University	Nutritional and metabolic significance of selenium	FEDRIP 2002
Burk, RF	Vanderbilt University	Selenium supplementation of patients with cirrhosis	CRISP 2001
Burk, RF	Vanderbilt University	Selenoprotein-P structure, function, and activity	CRISP 2001
Carlson, SG	National Institutes of Health	Antioxidant protection in age-associated atherosclerosis	FEDRIP 2002
Cassano, PA	Cornell University	Nutritional influences on lung disease	CRIS/UDSA 2001
Chirase, NK	Texas A&M University	Nutritional and environmental stress and immune response of feeder cattle	FEDRIP 2002
Chu, F-F	National Institutes of Health	Selenium-afforded protection against atherosclerosis	FEDRIP 2002
Clarke, LC	University of Arizona	Phase II chemoprevention trial of selenium and prostate cancer	CRISP 2002

3. HEALTH EFFECTS

Table 3-8. On-going Studies on Selenium Health Effects

Investigator	Institute	Research area	Reference
Clarke, LC and Marshall, JR	University of Arizona	Randomized, controlled chemoprevention trials in populations at very high risk for prostate cancer: Elevated prostate-specific antigen and high-grade prostatic intraepithelial neoplasia	CRISP 2002
Cohen, HJ	Stanford University	Relationship of the synthesis and secretion of an extracellular selenium dependent glutathione peroxidase to changes in renal function	CRISP 2001
Cohen, HJ	Stanford University	Selenium nutrition—Effects on blood cell function	FEDRIP 2002
Coltman, CA	CTRC Research Foundation	Chemoprevention of prostate cancer	CRISP 2001
Combs, GF	Cornell University	Characterization of antioxidant status of a large cohort of free-living Americans	FEDRIP 2002
Combs, GF	Cornell University	Dietary selenium and maintenance of colonic health	FEDRIP 2002
Combs, GF	Cornell University	Metabolic events at extremes of selenium intake; characterization of antioxidant status of a large cohort of free-living Americans	CRIS/UDSA 2001
Combs, GF	Cornell University	Kinetics of organic and inorganic selenium during dietary supplementation	CRIS/UDSA 2001
Costello, AJ	University of Melbourne	A randomized, controlled chemoprevention trial of selenium in familial prostate cancer: Rationale, recruitment, and design issues	Costello 2001
Davis, CD	Agricultural Research Service	Role of selenium in cancer susceptibility	CRIS/UDSA 2001
Diamond, AM	University of Illinois	Mechanism by which selenium protects against mutagenesis	CRISP 2001
Diamond, AM	University of Illinois	Selenium, amino thiols, and radiation	CRISP 2002
Doolittle, JJ	South Dakota University	Bioavailability of nutrients and contaminants in soil	FEDRIP 2002
Driscoll, DM	Cleveland Clinic Foundation	Mechanism of selenoperoxidase biosynthesis	CRISP 2001
Driskell, JA	University of Nebraska	Nutrient bioavailability: A key to human nutrition	FEDRIP 2002
El-Bayoumy, KE	American Health Foundation	Chemoprevention of oral cancer: model studies	CRISP 2001
El-Bayoumy, KE	American Health Foundation	Chemoprevention of lung cancer by organoselenium: Model studies	CRISP 2002

3. HEALTH EFFECTS

Table 3-8. On-going Studies on Selenium Health Effects

Investigator	Institute	Research area	Reference
El-Bayoumy, KE	American Health Foundation	Chemoprevention of mammary cancer by organoselenium	CRISP 2001
Fawzi, WW	National Institutes of Health	Trials of vitamins in HIV positive progression and transmission	FEDRIP 2002
Fiala, E	American Health Foundation	Organoselenium compounds as modifiers of initiation/postinitiation carcinogenesis	CRISP 2002
Finley, JW	University of North Dakota	Chemical forms of selenium in foods	FEDRIP 2002
Finley, JW	Oregon State University	Health benefits of high-selenium foods to humans	FEDRIP 2002
Funt, RC and Clinton, S	Ohio State University	Increasing the antioxidant level in Ohio berries for potential prevention and intervention of certain cancers in humans	FEDRIP 2002
Ganther, H	Roswell Park Memorial Institute	Selenium metabolism and anti-carcinogenic action	CRISP 2001
Ganther, H	University of Wisconsin	Organoselenium compounds biosynthesis and function	CRIS/UDSA 2001
Gesteland, RF	University of Utah	Genetic analysis of synthesis of selenium containing proteins	CRISP 2001
Gladyshev, VN	University of Nebraska	Biochemistry and molecular biology of selenium containing enzymes	CRIS/UDSA 2001
Gladyshev, VN	University of Nebraska	Identity of terminator and selenocysteine UGA codons	CRISP 2001
Glauert, HP	University of Kentucky	Effect of dietary antioxidants on hepatic NF-KB activation	CRIS/UDSA 2001
Gorbach, SL	Tufts University	Impact of micronutrients on progression of SIV	FEDRIP 2002
Gorbach, SL	Harvard University	Wasting, nutritional status, and micronutrients	FEDRIP 2002
Gottschall, EB	National Jewish Medical and Research Center	Randomized, placebo-controlled, double blind trial of asbestos-exposed workers using high selenium yeast supplementation	CRISP 2001
Gottschall, EB	National Jewish Medical and Research Center	Selenium and lung cancer risk in asbestos workers	CRISP 2002
Guttenplan, JB	New York University	Antimutagenesis by lycopene and selenium in rodents	CRISP 2001
Hakala TR	Department of Veterans Affairs	Select trial	FEDRIP 2002
Honn, KV	Wayne State University	Prostate cancer	FEDRIP 2002
Hurwitz, BE	University of Miami	Drug abuse, HIV, selenium supplementation, and CVD risk	FEDRIP 2002

3. HEALTH EFFECTS

Table 3-8. On-going Studies on Selenium Health Effects

Investigator	Institute	Research area	Reference
Ip, C	Roswell Park Memorial Institute	Mammary cancer prevention by novel selenium compounds	CRISP 2002
James, LF	Agricultural Research Service	Livestock poisoning from <i>Astragalus</i> and <i>Oxytropis</i> species	CRIS/UDSA 2001
Johnson, JL	University of Nebraska	Interaction of trace minerals as related to prenatal supplementation of the pregnant beef cow	FEDRIP 2002
Kadlubar, F	Not available	Environmental and genetic epidemiology of colorectal adenomas	CRISP 2002
Karagas, M	Not available	Epidemiology of arsenic and other toxic metals	CRISP 2002
Kegley, EB and Kellogg, DW	University of Arkansas	Effect of trace mineral level and source on immune function and performance of weaned beef cattle	FEDRIP 2002
Kim, J	University of Texas MD Anderson Cancer Center	Feasibility study of L-selenomethionine in prevention of prostate cancer	CRISP 2001
Kiremidjian-Schumacher, L et al.	New York University, College of Dentistry	Dietary selenium and immunocompetence in the elderly	FEDRIP 2002
Klein, EA	Cleveland Clinic Foundation	SELECT: The selenium and vitamin E cancer prevention trial: Rationale and design	Klein et al. 2000
Kolonel, LN	University of Hawaii at Manoa	Biomarkers of prostate cancer risk in a multi-ethnic cohort	CRISP 2001
Kolonel, LN	University of Hawaii at Manoa	Epidemiologic studies of diet and cancer in Hawaii	CRISP 2001
Koutnik, V	University of Brno	Selenium in food chains and its impact on human health	CRIS/UDSA 2001
Lacourciere, G and Nhlbi, NIH	National Institutes of Health	Utilization of selenocysteine in selenophosphate biosynthesis	FEDRIP 2002
Lei, X	Cornell University	Antioxidative role of glutathione peroxidase in transgenic mice	CRISP 2001
Lei, XG et al.	Cornell University	Developing an organic selenium supplement for animal nutrition and environmental protection	FEDRIP 2002
Lei, XG et al.	Cornell University	Mineral nutrition in animal agriculture and environmental protection	FEDRIP 2002
Lemarchand, L	University of Hawaii	Phytochemicals and lung risk in a multi ethnic cohort	FEDRIP 2002
Levander, OA	Agricultural Research Service	Role of vitamin E and selenium in human health promotion	CRIS/UDSA 2001
Levander, OA	University of Maryland	Kinetics of organic and inorganic selenium during dietary supplementation	CRIS/UDSA 2001

3. HEALTH EFFECTS

Table 3-8. On-going Studies on Selenium Health Effects

Investigator	Institute	Research area	Reference
Lewis, NS	California Institute of Technology	Picosecond dynamic studies of electron transfer rates as III-V semiconductor/liquid interfaces	FEDRIP 2002
Longnecker, M	National Institutes of Health	Validity of toenail element levels as a surrogate measure of exposure	CRISP 2002
Mahan, DC	Ohio State University	Mineral and vitamin nutrition of swine	FEDRIP 2002
Mark, S	Not available	Intervention trials and related studies	CRISP 2002
Marshall, JR	University of Arizona	Phase II chemoprevention trial of selenium and prostate cancer	CRISP 2002
May, JM	Vanderbilt University	Antioxidant interactions of selenium and vitamins C and E	CRISP 2001
Medina, D	Roswell Park Memorial Institute	Selenoproteins in rat mammary tumorigenesis	CRISP 2001
Medina, D	Roswell Park Memorial Institute	Selenium modified gene expression in the carcinogen treated mammary gland	CRISP 2002
Morgan, DL	National Institutes of Health	Toxicity of chemicals used in the semiconductor industry	FEDRIP 2002
Nomura, AM	Kuakini Medical Center	Cancer epidemiology of migrant Japanese in Hawaii	CRISP 2001
Ogasawara, Y and Nhlbi, NIH	National Institutes of Health	Properties of selenotrisulfides and perselenides	FEDRIP 2002
Page, JG	Not available	Thirteen week oral toxicity study of 1,4-phenylenebis (methylene) selenocyanate	CRISP 2002
Palmer, IS	South Dakota University	Biochemistry of selenium	FEDRIP 2002
Pence, BC	Texas Technical University Health Sciences Center	Induction by selenium of the antioxidant and the prooxidant, apoptotic pathways in cultured cells	CRISP 2001
Penland, JG	Department of Agriculture	Mineral element nutrition, neuropsychological function and behavior	FEDRIP 2002
Powis, G	University of Arizona	Thioredoxin reductases and cancer	CRISP 2001
Prolla, TA	University of Wisconsin	Role of dietary selenium in intestinal tumorigenesis	CRISP 2001
Rao, L	University of Wisconsin	Genetic characterization of the selenoenzyme phospholipids-hydroperoxide glutathione peroxidase	CRISP 2001
Reddy, BS	American Health Foundation	Chemoprevention of colon cancer by organoselenium compounds	CRISP 2002
Reddy, CC	Pennsylvania State University	Antioxidant effects on prostaglandin metabolism, lipid peroxidation, and immunologic defense	CRIS/UDSA 2001

3. HEALTH EFFECTS

Table 3-8. On-going Studies on Selenium Health Effects

Investigator	Institute	Research area	Reference
Repine, JE	Department of Veterans Affairs	Effect of NAC and/or selenium on blood markers of oxidative stress and inflammation	FEDRIP 2002
Roberts, JC	University of Utah	Advances in selenium supplementation	CRISP 2002
Roughead, ZK	Department of Agriculture	Biomarkers for assessment of human mineral nutritional status and requirements	FEDRIP 2002
Roy, M	New York University	Selenium supplementation and immunocompetence in the elderly	CRIS/UDSA 2001
Sampliner, RE	Department of Veterans Affairs	Phase III study of the effects of celecoxib, selenium, or the combination on adenomatous polyp recurrence in adenomatous polyp patients	FEDRIP 2002
Sevanian, A	University of Southern California	Oxidant stress and atherogenicity of oxidized LDL	FEDRIP 2002
Shearer, TR	Oregon Health & Science University	Mechanism of selenium induced cataract	FEDRIP 2002
Simoneau, AR	Department of Veterans Affairs	Selenium in prostate cancer	FEDRIP 2002
Smith, AM	Ohio State University	Influence of gender and life cycle on selenium requirements and metabolism	CRIS/UDSA 2001
Sordillo, LM	Pennsylvania State University	Oxidant stress and endothelial cell metabolism	FEDRIP 2002
Sordillo, LM	Pennsylvania State University	Mechanisms of endothelial cell dysfunction during selenium deficiency	FEDRIP 2002
Stadtman, TC and Nihli, NIH	National Institutes of Health	Selenium biochemistry	FEDRIP 2002
Stampfer, MJ	National Cancer Institute	Nutritional and biochemical markers of cancer	FEDRIP 2002
Stampfer, MJ	Harvard University	Prospective study of diet and bladder cancer	FEDRIP 2002
Sunde, RA	University of Missouri	New essential roles for selenium; regulatory elements of selenium-dependent peroxidases; regulatory elements of the rat glutathione peroxidase gene	CRIS/UDSA 2001
Sunde, RA	University of Missouri	Glutathione peroxidases: Selenium requirement and function	FEDRIP 2002
Taylor, JR	Department of Veterans Affairs	Prevention of non-melanoma skin cancer with a nutritional supplementation of selenium	FEDRIP 2002
Taylor, EW	University of Georgia	Selenoproteins, NF-KB, and HIV disease in drug users	CRISP 2001

3. HEALTH EFFECTS

Table 3-8. On-going Studies on Selenium Health Effects

Investigator	Institute	Research area	Reference
Terris, MK	Department of Veterans Affairs	Blood and tissue sampling in prostate ultrasound patients	FEDRIP 2002
Terris, MK	Department of Veterans Affairs	Phase II study of the effect of selenium supplementation on the progression of prostate cancer	FEDRIP 2002
Thompson, I	University of Texas Health Science Center San Antonio	Biomarkers of risk for prostate cancer	CRISP 2001
Thompson, H	Roswell Park Memorial Institute	Mechanisms of selenium anticancer and toxic activities	CRISP 2001
Thompson, H	Roswell Park Memorial Institute	Selenium and lung cancer risk	CRISP 2002
Turnlund, JR et al.	Department of Agriculture	Influence of dietary intervention on mineral homeostasis	FEDRIP 2002
Turnlund, JR et al.	Department of Agriculture	Trace element metabolism, status and requirements of humans	FEDRIP 2002
Veillon, C	Agricultural Research Service	Metabolism, function, and interactions of selenium using stable isotopes	CRIS/USDA 2001
Weiss, GR	Department of Veterans Affairs	Pilot study of 1-selenomethionine in prostate cancer patients scheduled to undergo radical prostatectomy	FEDRIP 2002
Weiss, SL	University of Missouri	Molecular basis for selenium regulation of glutathione peroxidase mRNA	CRIS/USDA 2001
Whanger, PD	Oregon State University	Effect of selenium on selenoproteins in human muscle and brain cells	FEDRIP 2002
Whanger, PD	Oregon State University	Metabolic function of selenoprotein	CRISP 2001
Whanger, P	Oregon State University	Role of selenium and vitamin E in scour and immunity of newborn calves; influence of pregnancy on selenium metabolism in women of low selenium status; metabolic relationship between selenium and myopathy	CRIS/USDA 2001
Yu, MC	University of Southern California	Singapore cohort study of diet and cancer	CRISP 2001

CRIS = Current Research Information System; CRISP = Computer Retrieval of Information on Science Projects; FEDRIP = Federal Research in Progress; NCI = National Cancer Institute; NIH = National Institutes of Health; USDA = US Department of Agriculture

4. CHEMICAL AND PHYSICAL INFORMATION

4.1 CHEMICAL IDENTITY

Information regarding the chemical identity of selenium and selenium compounds is presented in Table 4-1.

4.2 PHYSICAL AND CHEMICAL PROPERTIES

Selenium is a non-metal element with atomic number 34 and an atomic mass of 78.96 (Lide 2000). Selenium belongs to Group 6 (Group VIA) of the periodic table, located between sulfur and tellurium, and resembles sulfur both in its various forms and in its compounds. The six stable isotopes of selenium are ^{74}Se , ^{76}Se , ^{77}Se , ^{78}Se , ^{80}Se , and ^{82}Se . These isotopes occur naturally with approximate abundances of 0.87, 9.02, 7.58, 23.52, 49.82, and 9.19%, respectively (Hoffmann and King 1997). Artificial radioactive isotopes of selenium have also been created by neutron activation. The gamma-emitting isotope ^{75}Se has been used in diagnostic applications of medicine (Hoffmann and King 1997). Selenium exists in several allotropic forms. Three are generally recognized, but as many as six have been claimed (Lide 2000). The stable form at ordinary room temperatures is the grey or hexagonal form with a melting point of 220.5 °C (Lide 2000). The other two important forms are red (monoclinic) with a melting point of 221 °C and amorphous selenium, which exists in black and red forms. Black amorphous selenium is vitreous and is formed by the rapid cooling of liquid selenium. Red amorphous selenium is colloidal and is formed in reduction reactions (Hoffmann and King 1997). Important selenium oxidation states are -2, 0, +4, and +6.

The chemical properties of selenium are similar to sulfur. Selenium combines with metals and many nonmetals directly or in aqueous solution. The selenides resemble sulfides in appearance, composition, and properties (Hoffmann and King 1997). Selenium may form halides by reacting vigorously with fluorine and chlorine, but the reactions with bromine and iodine are not as rapid. Selenium does not react directly with hydrogen fluoride or hydrogen chloride, but decomposes hydrogen iodide to liberate iodine and yield hydrogen selenide (Hoffmann and King 1997). Selenium reacts with oxygen to form a number of oxides, the most stable of which is selenium dioxide.

Information regarding the physical and chemical properties of selenium and selenium compounds is located in Table 4-2.

4. CHEMICAL AND PHYSICAL INFORMATION

Table 4-1. Chemical Identity of Selenium and Selected Compounds^a

Characteristic	Selenium	Hydrogen selenide	Selenic acid	Selenious acid
Synonyms	Elemental selenium; selenium base; selenium dust; colloidal selenium; selenium homopolymer ^b ; selenium alloy	Dihydrogen selenide; hydrogen selenide [H ₂ Se]; selenium anhydride; selenium dihydride; selenium hydride; selane	Selenic acid, liquid ^{DOT,b}	Monohydrated selenium dioxide; selenous
Registered trade name(s)	C.I. 77805; VANDEX ^b			
Chemical formula	Se	H ₂ Se	H ₂ SeO ₄	H ₂ SeO ₃
Wisewesser line notation	SE	H2 SE	H2.SE-04	H2SE-03
Identification numbers:				
CAS	7782-49-2	7783-07-5	7783-08-6	7783-00-8
NIOSH RTECS	VS7700000	MX1050000	VS6575000	VS7175000
EPA hazardous waste	No data	No data	No data	U204 ^c
OHM/TADS	7216880	No data	No data	No data
DOT/UN/NA/IMCO shipping	UN 2658 ^b	UN 2202; Hydrogen selenide; anhydrous	UN 1905; IMCO 8.0	No data
HSDB	4493	548	675	6065
NCI	No data	No data	No data	No data

4. CHEMICAL AND PHYSICAL INFORMATION

Table 4-1. Chemical Identity of Selenium and Selected Compounds^a

Characteristic	Sodium selenate	Potassium selenate	Sodium selenide	Sodium selenite
Synonyms	Disodium selenate	Selenic acid, dipotassium salt ^b	Disodium monoselenide ^b	Disodium selenite; disodium selenium trioxide; selenious acid disodium salt; sodium selenium oxide
Registered trade name(s)	P-40 ^b ; Sel-Tox SS02 and SS-20 ^c	No data	No data	
Chemical formula	Na ₂ SeO ₄ ^d	K ₂ SeO ₄	Na ₂ Se ^b	Na ₂ SeO ₃ ^d
Wisewesser line notation	NA2 SE-04 ^b	KA2 SE-04	NA2 SE	NAS SE-03
Identification numbers:				
CAS	13410-01-0	7790-59-2	1313-85-5 ^b	10102-18-8
NIOSH RTECS	No data	VS6600000	WE0350000 ^b	VS7350000
EPA hazardous waste	No data	No data	No data	No data
OHM/TADS	No data	No data	No data	7217299
DOT/UN/NA/IMCO shipping	No data	No data	No data	UN 2630 ^b
HSDB	No data	No data	No data	768
NCI	No data	No data	No data	No data

4. CHEMICAL AND PHYSICAL INFORMATION

Table 4-1. Chemical Identity of Selenium and Selected Compounds^a

Characteristic	Selenium dioxide	Selenium trioxide	Selenocystine	Selenomethionine
Synonyms	Selenious anhydride; selenium oxide; selenium oxide [SeO ₂]; selenous acid anhydride	No data	Selenium cystine ^b ; 3,3-diselenodi-DL-alanine ^b ; seleno-DL-cystine ^b ; DL-selenocystine ^b	Methionine, seleno ^b ; 2-amino-4-(methylselenyl) butyric acid; 2-amino-4-(methylseleno)
Registered trade name(s)	No data	No data		
Chemical formula	SeO ₂	SeO ₃ ^e	C ₂ H ₄ NO ₂ (CH ₂)Se 2(CH ₂)C ₂ H ₄ NO ₂	(CH ₃)Se(CH ₂) ₂ C ₂ H ₄ NO ₂
Identification numbers:				
CAS	7446-08-04	13768-86-0 ^f	1464-43-3 ^b	1464-42-2
NIOSH RTECS	VS8575000	No data	AY6030000 ^b	ES100000
EPA hazardous waste	V204 ^c	No data	No data	No data
OHM/TADS	7800105	No data	No data	No data
DOT/UN/NA/IMCO shipping	No data	No data	No data	No data
HSDB	677	No data	No data	No data
NCI	No data	No data	No data	No data

4. CHEMICAL AND PHYSICAL INFORMATION

Table 4-1. Chemical Identity of Selenium and Selected Compounds^a

Characteristic	Selenium sulfide	Selenium disulfide
Synonyms	Selenium monosulfide; selenium sulfide [SeS]; selensulfid (German); sulfur selenide (SSe)	Selenium disulphide; selenium sulfide ^b ; sulfur selenide
Registered trade name(s)	No data	Exsel; Selsun Blue; Selsum ^b ; Seleen
Chemical formula	SeS	SeS ₂ ^b
Wisewesser line notation	SE S	SE S ₂ ^b
Identification numbers:		
CAS	744-34-6	7488-56-4
NIOSH RTECS	VTO525000	VS8925000
EPA hazard waste	V205 ^b	V205
OHM/TADS	8400272	8400272
DOT/UN/NA/IMCO shipping	No data	UN 2657
HSDB	679	No data
NCI	NCI-C50033	No data

^aAll information obtained from HSDB 2001, except where noted

^bRTECS 2001

^cEPA 1980a, 1980b (40 CFR 261.33)

^dBudavari et al. 1996

^eLide 2000

^fChemIDplus 3003

CAS = Chemical Abstracts Service; DOT/UN/NA/IMCO = Department of Transportation/United Nations/North America/International Maritime Dangerous Goods Code; EPA = Environmental Protection Agency; HSDB = Hazardous Substances Data Bank; NCI = National Cancer Institute; NIOSH = National Institute for Occupational Safety and Health; OHM/TADS = Oil and Hazardous Materials/Technical Assistance Data System; RTECS = Registry of Toxic Effects of Chemical Substances

4. CHEMICAL AND PHYSICAL INFORMATION

Table 4-2. Physical and Chemical Properties of Selenium and Selenium Compounds^a

Property	Selenium	Hydrogen selenide	Selenic acid	Selenious acid
Molecular weight	78.96	80.98	144.97	128.97
Color/form	Red, grey, or black	Colorless ^b	White hexagonal prisms; hygroscopic ^b	White hygroscopic prisms ^b
Physical state	Solid	Gas	Solid	Solid
Melting point	221 °C(red); 220.5 °C (grey); 180 °C (black) ^b	-65.73 °C	58 °C	70 °C (decomposes) ^b
Boiling point	685 °C	-41.3 °C	260 °C	None, loses water upon heating
Density (g/cm ³)	4.39 (red); 4.81 (grey); 4.28 (black) ^b	2.12 (-42 °C)	2.9508 (15 °C)	3.004 (15 °C)
Odor	Unknown; upon combustion, smells like rotten horseradish	Disagreeable odor	No data	No data
Odor threshold: Water (mg/m ³)	No data	No data	No data	No data
Air	No data	No data	No data	No data
Solubility: Water	Insoluble	377 mL/100 mL at 4 °C; 270 mL/100 mL at 22.5 °C; 0.73 mL/100 mL at 20 °C ^c	Very soluble in hot water	90 parts dissolve in 100 parts of water at 0 °C; 400 parts in 100 parts at 90 °C
Organic solvent(s)	Insoluble in alcohol, slightly soluble in carbon disulfide (2 mg/100 mL, room temperature), soluble in ether	Soluble in carbon disulfide, carbonyl chloride	Decomposes in alcohol ^b	Very soluble in alcohol
Partion coefficients: Log K _{ow}	No data	No data	No data	No data
Log K _{oc}	No data	No data	No data	No data
Vapor pressure	1 mmHg at 356 °C (grey)	1,330 mmHg at -30 °C; 3,420 mmHg at 0.2 °C; 9,120 mmHg at 30.8 °C	No data	2 mmHg at 15 °C; 4.5 mmHg at 33 °C; 7mmHg at 40.3 °C
Henry's Law constant	Not applicable	No data	Not applicable	Not applicable
Autoignition temperature	No data	No data	No data	No data

4. CHEMICAL AND PHYSICAL INFORMATION

Table 4-2. Physical and Chemical Properties of Selenium and Selenium Compounds^a

Property	Selenium	Hydrogen selenide	Selenic acid	Selenious acid
Flashpoint	No data	Not applicable	No data	No data
Flammability limits	No data	No data	No data	No data
Conversion factors	No data	ppm selenium to mg Selenium/m ³ in air (20 °C): ppm selenium x 3.23=mg selenium/m ³ to ppm selenium in air (20 °C): mg selenium/m ³ x 0.31=ppm selenium (v/v)	No data	No data
Explosive limits	Unknown ^d	No data	No data	No data

4. CHEMICAL AND PHYSICAL INFORMATION

Table 4-2. Physical and Chemical Properties of Selenium and Selenium Compounds^a

Property	Sodium selenate	Potassium selenate	Sodium selenide	Sodium selenite
Molecular weight	188.94	221.15	124.94	172.94
Color/form	White crystals	Colorless crystals or white powder	Crystalline; turns red on exposure to air and deliquesces	White tetragonal crystals ^b
Physical state	Solid	Solid	Solid	Solid
Melting point	No data	No data	>875 °C	No data
Boiling point	No data	No data	No data	No data
Density (g/cm ³)	1.61 ^b	3.07	2.625 (10 °C)	No data
Odor	No data	No data	No data	No data
Odor threshold:				
Water (mg/m ³)	No data	No data	No data	No data
Air	No data	No data	No data	No data
Solubility:				
Water	Very soluble in water	Soluble in about 1 part of water	Decomposes in water	Freely soluble in water
Organic solvent(s)	No data	No data	No data	No data
Partition coefficients:				
Log K _{ow}	No data	No data	No data	No data
Log K _{oc}	No data	No data	No data	No data
Vapor pressure	No data	No data	No data	No data
Henry's Law constant	No data	No data	No data	No data
Autoignition temperature	No data	No data	Not flammable ^e	Not flammable ^e
Flashpoint	No data	No data	Not flammable ^e	Not flammable ^e
Flammability limits	No data	No data	Not flammable ^e	Not flammable ^e
Conversion factors	No data	No data	No data	No data
Explosive limits	No data	No data	No data	No data

4. CHEMICAL AND PHYSICAL INFORMATION

Table 4-2. Physical and Chemical Properties of Selenium and Selenium Compounds^a

Property	Selenium dioxide	Selenium trioxide	Selenocystine	Selenomethionine
Molecular weight	110.96	126.96 ^b	334.12 ^c	196.11
Color/form	Lustrous, tetragonal needles; yellowish-green vapor	White crystals ^b	No data	Transparent, hexagonal sheets or plates; metallic luster or crystals
Physical state	Solid	Solid	No data	Solid
Melting point	340 °C; sublimes at 315 °C ^b	118 °C ^b	No data	DL form: 265 °C (decomposes); L form: 266–268 °C
Boiling point	None ^b	Sublimes ^b	No data	Not applicable
Density (g/cm ³)	3.954 (15 °C)	3.44 ^b	No data	No data
Odor	Pungent sour smell	No data	No data	No data
Odor threshold:				
Water (mg/m ³)	0.0002 ^e	No data	No data	No data
Air	No data	No data	No data	No data
Solubility:				
Water (g/100 mL)	38.4 at 14 °C;	Soluble in water	No data	No data
Organic solvent(s) (parts/100 parts solvent)	in methanol: 10.16 at 11.8 °C; in 93% ethanol: 6.67 at 14 °C; in acetone: 4.35 at 15.3 °C; in acetic acid: 1.11 at 13.9 °C; soluble in benzene	No data	No data	No data
Partition coefficients:				
Log K _{ow}	No data	No data	No data	No data
Log K _{oc}	No data	No data	No data	No data
Vapor pressure	12.5 mm Hg at 70 °C; 20.2 mm Hg at 94 °C; 39.0 mm Hg at 181 °C; 760 mm Hg at 315 °C; 848 mm Hg at 320 °C	No data	No data No data	No data No data
Henry's Law constant	Not applicable	Not applicable	No data	No data
Autoignition temperature	Not flammable ^e	Not flammable ^e	No data	No data
Flashpoint	Not flammable ^e	Not flammable ^e	No data	No data

4. CHEMICAL AND PHYSICAL INFORMATION

Table 4-2. Physical and Chemical Properties of Selenium and Selenium Compounds^a

Property	Selenium dioxide	Selenium trioxide	Selenocystine	Selenomethionine
Flammability limits	Not flammable ^e	Not flammable ^e	No data	No data
Conversion factors	ppm (v/v) to mg/m ³ in air (20 °C): ppm (v/v) x 4.53=mg/m ³ ; mg/m ³ to ppm (v/v) in air (20 °C): mg/m ³ x 0.22=ppm (v/v)	No data	No data	No data
Explosive limits	No data	No data	No data	No data

4. CHEMICAL AND PHYSICAL INFORMATION

Table 4-2. Physical and Chemical Properties of Selenium and Selenium Compounds^a

Property	Selenium sulfide	Selenium disulfide
Molecular weight	111.02 ^f	143.08 ^f
Color/form	Orange-yellow tablets or powder ^f	Bright red-yellow powder ^f
Physical state	Solid ^f	Solid ^f
Melting point	118–119 °C (decomposes) ^f	<100 °C ^f
Boiling point	No data	No data
Density (g/cm ³)	3.056 (0 °C) ^f	No data
Odor	No data	No data
Odor threshold:		
Water (mg/m ³)	No data	No data
Air	No data	No data
Solubility:		
Water	Insoluble	Insoluble
Organic solvent(s)	Insoluble in ether; decomposes in alcohol ^f	No data
Partition coefficients:		
Log K _{ow}	Not applicable	No data
Log K _{oc}	Not applicable	No data
Vapor pressure	Not applicable	Not applicable
Henry's Law constant	Not applicable	Not applicable
Autoignition temperature	No data	No data
Flashpoint	No data	No data
Flammability limits	No data	No data
Conversion factors	No data	No data
Explosive limits	No data	No data

^aAll information obtained from Budavari et al. 1996, unless otherwise noted.

^bLide 2000

^cRTECS 2001

^dNIOSH/OSHA 1981

^eWeiss 1986

^fLide 1993

Note: The gray metallic form is the most stable form of selenium (Budavari et al. 1996).

5. PRODUCTION, IMPORT/EXPORT, USE, AND DISPOSAL

5.1 PRODUCTION

Selenium is distributed widely in nature and is found in most rocks and soils at concentrations between 0.1 and 2.0 ppm (Fishbein 1983). However, elemental selenium is seldom found naturally, but it is obtained primarily as a byproduct of copper refining (Fishbein 1983). Selenium is contained in the constituents of the copper anode that are not solubilized during the copper refining process and ultimately accumulate on the bottom of the electrorefining tank. These constituents, usually referred to as slimes, contain roughly 5–25% selenium and 2–10% tellurium. Selenium is commercially produced by either soda ash roasting or sulfuric acid roasting of the copper slimes.

Soda Ash Roasting. A soda ash binder is mixed with the slimes and water to form a stiff paste. The paste is extruded or pelletized and allowed to dry and then roasted at 530–650 °C. The roasted product is then ground and leached into water. The resultant hexavalent selenium dissolves as sodium selenate, Na_2SeO_4 . The sodium selenate may be reduced by controlled heating to sodium selenide, which is leached with water to form a liver-red solution of sodium selenide that is readily oxidized to the elemental form by blowing air through the solution (Hoffmann and King 1997). A second process for the reduction of hexavalent selenium involves the use of concentrated hydrochloric acid or ferrous iron salts catalyzed by chloride ions as the reductant (Hoffmann and King 1997).

Sulfuric Acid Roasting. In this method, the copper slimes are mixed with sulfuric acid and roasted at 500–600 °C to produce selenium dioxide, which volatilizes readily at the roasting temperature. The selenium dioxide is reduced to elemental selenium during the scrubbing process with sulfur dioxide and water. The resultant commercial-grade selenium can be purified to 99.5–99.7% (Hoffmann and King 1997).

The U.S. production of selenium was 373 and 379 metric tons in 1995 and 1996, respectively (USGS 2001, 2002). No production data were reported for the years 1997–2001. All of the primary selenium producers in the United States are electrolytic copper refiners. Asarco Incorporated and Kennecott Utah Copper Corporation produce refined selenium in the United States (Hoffmann and King 1997; SRI 2000). Two other copper refiners, Phelps Dodge Corporation and Magma Copper Company, send selenium or

5. PRODUCT IMPORT/EXPORT, USE, AND DISPOSAL

selenium-bearing copper slimes outside of the United States for final processing (Hoffmann and King 1997).

Tables 5-1 and 5-2 list facilities in each state that produce, process, or import selenium and selenium compounds, respectively, for commercial use. The data do not include facilities such as electric power generating plants that release selenium unintentionally as a by-product. The intended use and the range of maximum amounts of these substances that are stored on site are also included. The data listed in these tables are derived from the Toxics Release Inventory (TRI00 2002). Only certain types of facilities were required to report. Therefore, this is not an exhaustive list.

5.2 IMPORT/EXPORT

The import volumes of selenium were 324, 428, 346, 339, 326, 452, and 500 metric tons for 1995, 1996, 1997, 1998, 1999, 2000, and 2001, respectively (USGS 2001, 2002). The U.S. exports of selenium were 270, 322, 127, 151, 233, 89, and 75 metric tons for 1995, 1996, 1997, 1998, 1999, 2000, and 2001, respectively (USGS 2001, 2002).

5.3 USE

In electronics, selenium's semiconductor and photoelectric properties make it useful in "electric eyes," photographic exposure meters, and rectifiers for home entertainment equipment. In addition, a large proportion of the available selenium is used to coat the metal cylinders from which a photographic image is transferred in xerography (Fishbein 1983). Selenium is widely used in the glass industry to counter coloration that results from iron impurities. It is also used in the production of both red and black glasses (Fishbein 1983). Selenium is contained in pigments that are used in plastics, paints, enamels, inks, and rubber (Fishbein 1983). Selenium is used as a catalyst in the preparation of pharmaceuticals including niacin and cortisone, as an ingredient in antidandruff shampoos (selenium sulfide), and as a constituent of fungicides (selenium sulfide) (IARC 1975a). Radioactive selenium is used in diagnostic medicine and aids in the visualization of difficult-to-study malignant tumors (Fishbein 1983; Jereb et al. 1975). Selenium is contained in some dietary supplements at concentrations in the range of 10–25 µg/tablet (Goodman et al. 1990). Selenium is also used as a nutritional feed additive for poultry and livestock, in pesticide formulations, and as an accelerator and vulcanizing agent in rubber production (Fishbein 1983; NAS 1976a). Table 5-3 lists some specific uses of selected selenium compounds.

5. PRODUCT IMPORT/EXPORT, USE, AND DISPOSAL

Table 5-1. Facilities that Produce, Process, or Use Selenium

State ^a	Number of facilities	Minimum amount on site in pounds ^b	Maximum amount on site in pounds ^b	Activities and uses ^c
AZ	1	1,000	9,999	12
CA	2	100	99,999	12
IA	1	100	999	7
IL	1	1,000	9,999	7
IN	2	100,000	999,999	8
LA	1	1,000	9,999	12
MI	1	0	99	12
OK	1	100	999	1, 5
OR	1	100,000	999,999	12
PA	2	10,000	99,999	6, 8
SC	1	10,000	99,999	1, 3, 4, 5, 9, 12, 13
WA	1	100	999	14
WY	1	0	99	1, 13

Source: TRI00 2002

^aPost office state abbreviations used^bAmounts on site reported by facilities in each state^cActivities/Uses:

- | | | |
|--------------------------|--------------------------|-----------------------------|
| 1. Produce | 6. Impurity | 11. Chemical Processing Aid |
| 2. Import | 7. Reactant | 12. Manufacturing Aid |
| 3. Onsite use/processing | 8. Formulation Component | 13. Ancillary/Other Uses |
| 4. Sale/Distribution | 9. Article Component | 14. Process Impurity |
| 5. Byproduct | 10. Repackaging | |

5. PRODUCT IMPORT/EXPORT, USE, AND DISPOSAL

Table 5-2. Facilities that Produce, Process, or Use Selenium Compounds

State ^a	Number of facilities	Minimum amount on site in pounds ^b	Maximum amount on site in pounds ^b	Activities and uses ^c
AL	4	100	99,999	1, 3, 4, 5, 8, 9, 12, 13
AR	1	10,000	99,999	12
AZ	2	10,000	999,999	1, 3, 4, 5, 9, 13, 14
CA	1	10,000	99,999	8, 9
FL	1	1,000	9,999	1, 5, 9, 12, 13, 14
GA	5	1,000	99,999	1, 2, 3, 4, 5, 6, 9, 13
IA	2	100	9,999	3, 4, 7, 8
ID	1	100,000	999,999	1, 5
IL	3	1,000	99,999	1, 5, 7, 12, 13
IN	4	0	99,999	1, 5, 7, 9, 12, 13
KY	5	100	99,999	1, 3, 4, 5, 9, 12, 13
LA	1	10,000	99,999	1, 3, 4, 5, 6, 8
MA	1	10,000	99,999	1, 5
MD	2	1,000	99,999	1, 3, 4, 5, 6, 13
MI	4	1,000	999,999	1, 2, 3, 4, 5, 8, 9, 12, 13
MN	1	1,000	9,999	1, 2, 9, 13, 14
MO	1	10,000	99,999	7
MT	1	10,000	99,999	1, 5, 12, 14
NC	3	10,000	99,999	1, 3, 4, 5, 9, 12, 13, 14
NM	4	0	99,999	1, 3, 4, 5, 9, 12, 13
NV	6	10,000	9,999,999	1, 5, 6, 10, 13, 14
OH	8	1,000	9,999,999	1, 3, 4, 5, 7, 9, 12, 13, 14
OK	1	1,000	9,999	8
PA	8	0	999,999	1, 4, 5, 6, 9, 12, 13, 14
SC	1	10,000	99,999	1, 3, 4, 5, 9, 12, 13
TN	2	1,000	99,999	1, 5
TX	10	10,000	999,999	1, 2, 3, 4, 5, 6, 8, 9, 12, 14
UT	4	10,000	9,999,999	1, 3, 4, 5, 6, 9, 12, 13
VA	1	10,000	99,999	1, 5
WV	9	100	99,999	1, 3, 4, 5, 9, 12, 13, 14
WY	2	0	99,999	1, 4, 5, 9, 12, 13

Source: TRI00 2002

^aPost office state abbreviations used^bAmounts on site reported by facilities in each state^cActivities/Uses:

- | | | |
|--------------------------|--------------------------|-----------------------------|
| 1. Produce | 6. Impurity | 11. Chemical Processing Aid |
| 2. Import | 7. Reactant | 12. Manufacturing Aid |
| 3. Onsite use/processing | 8. Formulation Component | 13. Ancillary/Other Uses |
| 4. Sale/Distribution | 9. Article Component | 14. Process Impurity |
| 5. Byproduct | 10. Repackaging | |

5. PRODUCT IMPORT/EXPORT, USE, AND DISPOSAL

Table 5-3. Some Selenium Compounds and Their Uses^a

Compound	Use
Elemental selenium	In rectifiers, photoelectric cells, blasting caps, xerography, stainless steel; as a dehydrogenation-catalyst
Sodium selenate (Na ₂ SeO ₄)	As an insecticide; in glass manufacture; in medicinals to control animal diseases
Sodium selenite (Na ₂ SeO ₃)	In glass manufacture; as a soil additive for selenium-deficient areas
Selenium diethyldithio- carbamate	Fungicide; vulcanizing agent
Selenium disulfide (SeS ₂)	In veterinary medicine
Selenium sulfide (SeS)	In anti-dandruff shampoos and in veterinary medicine
Selenium dioxide (SeO ₂)	Catalyst for oxidation, hydrogenation, or dehydrogenation of organic compounds
Selenium hexafluoride (SeF ₆)	As a gaseous electric insulator
Selenium oxychloride (SeOCl ₂)	Solvent for sulfur, selenium, tellurium, rubber, bakelite, gums, resins, glue, asphalt, and other materials
Aluminum selenide (Al ₂ Se ₃)	Preparation of hydrogen selenide for semi-conductors
Ammonium selenite [(NH ₄) ₂ SeO ₃]	Manufacture of red glass
Cadmium selenide	Photoconductors, photoelectric cells, rectifiers
Cupric selenate (CuSeO ₄)	In coloring copper and copper alloys
Tungsten diselenide (WSe ₂)	In lubricants

^aAdapted from Fishbein 1983

5. PRODUCT IMPORT/EXPORT, USE, AND DISPOSAL

The 2002 consumption patterns for selenium by industry were as follows: glass manufacturing, 35%; chemicals and pigments, 20%; electronics, 12%; and miscellaneous (including agriculture and metallurgy), 33% (USGS 2002).

5.4 DISPOSAL

Selenium was listed by EPA in 1973 as a nonradioactive hazardous element and, as such, is subject to many regulations (Dawson and Mercer 1986). Selenium compounds should be stored in a dry area to avoid contamination of water with selenium and to decrease the hazards that may result from human exposure to selenium-contaminated water (ITII 1976).

Disposal and waste treatment consist of treating an acidified solution of selenium with sodium sulfite to form the reducing agent sulfur dioxide. The selenium solution is then heated to produce elemental selenium, which is less mobile in the environment and less bioavailable, and the solution is filtered and washed (ITII 1976).

According to the TRI, in 2000, an estimated 76,248 pounds of elemental selenium and 1,782,654 pounds of selenium compounds were transferred off-site, presumably for disposal (TRI00 2002).

6. POTENTIAL FOR HUMAN EXPOSURE

6.1 OVERVIEW

Selenium has been identified in at least 508 of the 1,623 hazardous waste sites that have been proposed for inclusion on the EPA National Priorities List (NPL) (HazDat 2003). However, the number of sites evaluated for selenium is not known. The frequency of these sites can be seen in Figure 6-1. Of these sites, 502 are located within the United States, 4 are located in the Commonwealth of Puerto Rico, 1 is located in Guam, and 1 is located in the U.S. Virgin Islands (not shown).

Selenium is ubiquitous in the environment, being released from both natural and anthropogenic sources. The principal releases of selenium into the environment as a consequence of human activities result from the combustion of coal. Workers in the metals industry and health services, mechanics, and painters may be exposed to higher levels of selenium than the general population or persons employed in other trades. For the general population, the primary exposure pathways, in order of decreasing relative proportions, are food, water, and air. The relative proportions of these exposure pathways at hazardous waste sites are not known. Although selenium has been reported at hazardous waste sites, analysis on specific forms has not been performed. In air, selenium dioxide, methyl selenide, and dimethyl selenide are the most prevalent forms found in the atmosphere. Selenates and selenites are water soluble and, thus, can be found in water sources. Salts of selenic and selenious acids are most likely to be found in surface water and water contained in soil. Selenium sulfides would not be expected to be found at most hazardous waste sites, since they are usually manufactured for use in shampoos. Natural sources of selenium include the weathering of selenium-containing rocks to soils and volcanic eruptions.

The primary factor determining the fate of selenium in the environment is its oxidation state. Selenium is stable in four valence states (-2, 0, +4, and +6) and forms chemical compounds similar to those of sulfur. The heavy metal selenides (-2) are insoluble in water, as is elemental selenium. The inorganic alkali selenites (+4) and selenates (+6) are soluble in water (Weast 1988) and are therefore more bioavailable. Conditions such as pH (negative log hydrogen ion concentration), Eh (oxidation-reduction potential), and the presence of metal oxides affect the partitioning of the various compounds of selenium in the environment. In general, elemental selenium is stable in soils and is found at low levels in water because of its ability to coprecipitate with sediments. The soluble selenates are readily taken up by plants and

6. POTENTIAL FOR HUMAN EXPOSURE

Figure 6-1. Frequency of NPL Sites with Selenium Contamination

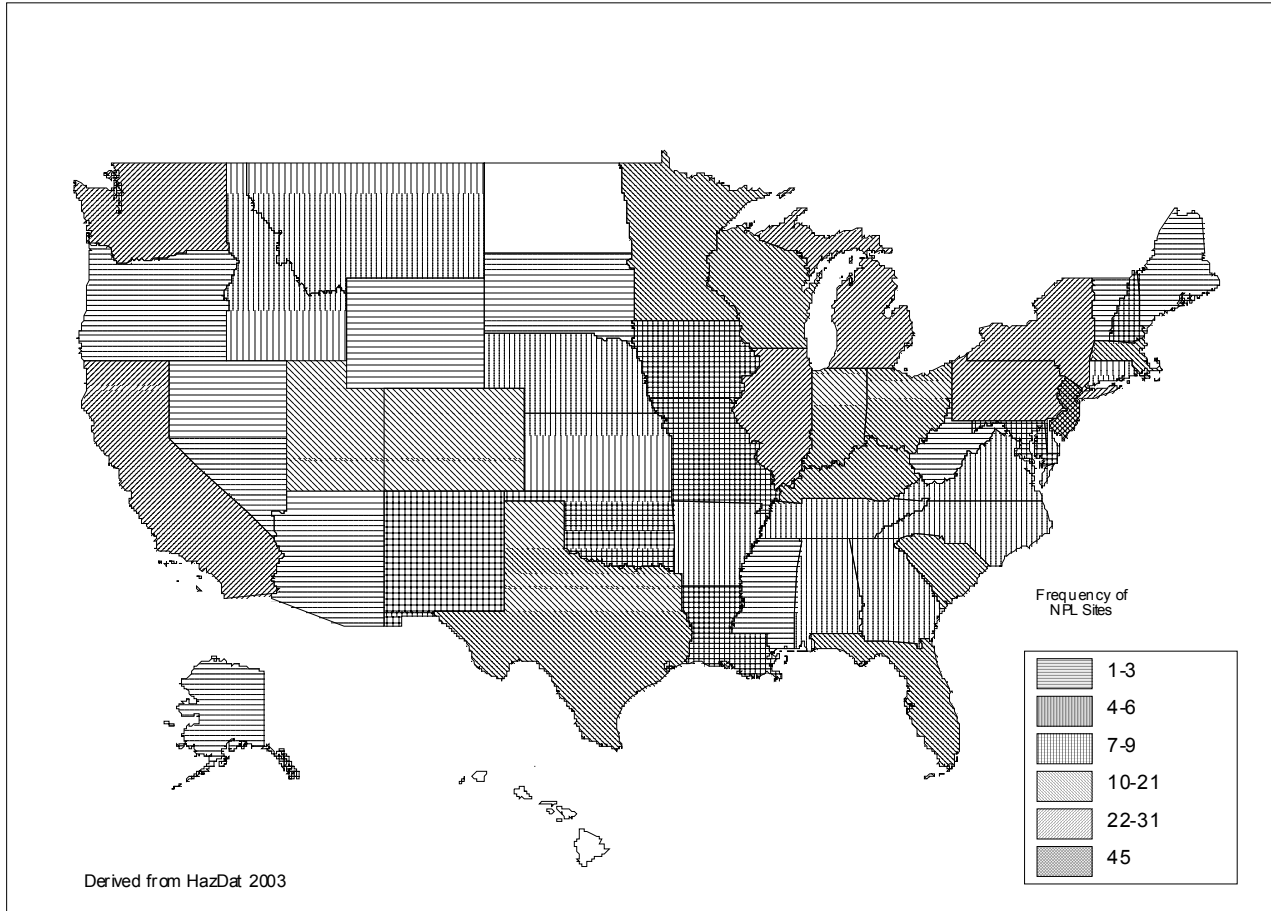

6. POTENTIAL FOR HUMAN EXPOSURE

converted to organic compounds such as selenomethionine, selenocysteine, dimethyl selenide, and dimethyl diselenide. Selenium is bioaccumulated by aquatic organisms and may also biomagnify in aquatic organisms.

6.2 RELEASES TO THE ENVIRONMENT

The greatest proportion of selenium released to the environment as a consequence of regulated human activities is in coal fly ash, resulting from coal combustion. Anthropogenic emission sources of atmospheric selenium include coal and oil combustion facilities, selenium refining factories, base metal smelting and refining factories, mining and milling operations, and end-product manufacturers (e.g., some semiconductor manufacturers). Natural atmospheric releases of selenium result from volatilization of selenium by plants and bacteria, and from volcanic activity. Some selenium is released to water via sewage effluent, agricultural runoff, and industrial waste water. Selenium is released to soil primarily by leaching and weathering of the parent bedrock material, although dry and wet deposition also contribute to soil selenium levels.

According to the Superfund Amendments and Reauthorization Act (SARA), Section 313, Toxic Release Inventory (TRI00 2002), an estimated total of 264,267 pounds of elemental selenium was released to air, water, land, or injected underground from manufacturing and processing facilities in the United States in 2000 (see Table 6-1). In addition, 7,870,609 pounds of selenium compounds were released to air, water, land, or injected underground in 2000 (see Table 6-2). These data include all facilities that manufacture, import, and process selenium and selenium compounds as well as facilities (electric generating facilities, petroleum facilities, etc.) with unintentional releases to the environment. The TRI data should be used with caution because only certain types of facilities are required to report. This is not an exhaustive list.

6.2.1 Air

Combustion of coal and other fossil fuels is the primary source of airborne selenium compounds. In air, elemental selenium burns to form selenium dioxide; however, during the combustion of fossil fuels, essentially all of the selenium dioxide produced should be reduced to elemental selenium by the sulfur dioxide that results from the combustion of these materials (NAS 1976a). Estimates of the quantity of selenium released to the air from fossil fuel combustion vary. Estimated annual selenium air emissions

6. POTENTIAL FOR HUMAN EXPOSURE

Table 6-1. Releases to the Environment from Facilities that Produce, Process, or Use Selenium

State ^b	Number of facilities	Reported amounts released in pounds per year ^a						
		Air ^c	Water	Under-ground injection	Land	Total on-site release ^d	Total off-site release ^e	Total on and off-site release
AZ	1	No data	No data	No data	No data	No data	71,747	71,747
CA	2	1	0	No data	35,848	35,849	10	35,859
IA	1	No data	No data	No data	27	27	339	366
IL	3	109	19	No data	1	129	231	360
IN	3	0	No data	No data	2,260	2,260	2,056	4,316
LA	2	No data	No data	40,246	No data	40,246	No data	40,246
MI	1	5	No data	No data	No data	5	5	10
OK	1	No data	250	No data	250	500	No data	500
OR	1	0	No data	No data	112,600	112,600	1	112,601
PA	2	61,437	750	No data	No data	62,187	1,857	64,044
SC	1	3,929	No data	No data	6,533	10,462	No data	10,462
WA	1	No data	No data	No data	2	2	2	4
WY	1	No data	No data	No data	No data	No data	0	0
Total	25	65,481	1,019	40,246	157,521	264,267	76,248	340,515

Source: TRI00 2002

^aData in TRI are maximum amounts released by each facility.^bPost office state abbreviations are used.^cThe sum of fugitive and stack releases are included in releases to air by a given facility.^dThe sum of all releases of the chemical to air, land, water, and underground injection wells.^eTotal amount of chemical transferred off-site, including to publicly owned treatment works (POTW).

6. POTENTIAL FOR HUMAN EXPOSURE

Table 6-2. Releases to the Environment from Facilities that Produce, Process, or Use Selenium Compounds

State ^b	Number of facilities	Reported amounts released in pounds per year ^a						Total on and off-site release
		Air ^c	Water	Under-ground injection	Land	Total on-site release ^d	Total off-site release ^e	
AL	4	15,545	4,125	No data	33,253	52,923	1,069	53,992
AR	1	546	No data	No data	No data	546	7,493	8,039
AZ	2	505	0	No data	820,005	820,510	2,265	822,775
CA	1	5	No data	No data	No data	5	No data	5
FL	2	7,105	No data	No data	362	7,467	3	7,470
GA	6	72,273	1,037	No data	43,067	116,377	10	116,387
IA	5	No data	No data	No data	No data	No data	No data	0
ID	1	1,849	No data	No data	98,184	100,033	5	100,038
IL	7	56	No data	No data	0	56	81,940	81,996
IN	5	4,427	1,871	No data	9,665	15,963	7,739	23,702
KY	5	19,750	14,200	No data	41,051	75,001	No data	75,001
LA	1	192	0	No data	No data	192	45,241	45,433
MA	1	234	100	No data	580	914	7,440	8,354
MD	2	16,001	360	No data	720	17,081	1,262	18,343
MI	4	16,408	2,417	No data	2,758,596	2,777,421	897,981	3,675,402
MN	2	255	2,400	No data	No data	2,655	265	2,920
MO	2	250	No data	No data	No data	250	250	500
MT	1	250	0	No data	13,000	13,250	250	13,500
NC	4	56,017	1,092	No data	27,080	84,189	10	84,199
NM	4	1,056	0	No data	91,282	92,338	24,300	116,638
NV	6	2,400	40	0	1,174,514	1,176,954	0	1,176,954
OH	9	71,941	16,635	No data	74,622	163,198	46,858	210,056
OK	1	9,000	No data	No data	No data	9,000	50	9,050
PA	8	39,509	2,093	No data	23,500	65,102	40,199	105,301
SC	1	4,174	No data	No data	11,605	15,779	No data	15,779
TN	2	14,010	4,600	No data	21,550	40,160	5	40,165

6. POTENTIAL FOR HUMAN EXPOSURE

Table 6-2. Releases to the Environment from Facilities that Produce, Process, or Use Selenium Compounds

Reported amounts released in pounds per year ^a								
State ^b	Number of facilities	Air ^c	Water	Under-ground injection	Land	Total on-site release ^d	Total off-site release ^e	Total on and off-site release
TX	12	131,637	22	27,699	197,164	356,522	609,353	965,875
UT	4	4,122	1,000	No data	1,635,235	1,640,357	263	1,640,620
VA	1	4,100	600	No data	14,000	18,700	No data	18,700
WV	9	72,843	3,456	No data	93,928	170,227	8,403	178,630
WY	2	10,469	No data	No data	26,970	37,439	No data	37,439
Total	119	576,929	56,048	27,699	7,209,933	7,870,609	1,782,654	9,653,263

Source: TRI00 2002

^aData in TRI are maximum amounts released by each facility.

^bPost office state abbreviations are used.

^cThe sum of fugitive and stack releases are included in releases to air by a given facility.

^dThe sum of all releases of the chemical to air, land, water, and underground injection wells.

^eTotal amount of chemical transferred off-site, including to publicly owned treatment works (POTW).

6. POTENTIAL FOR HUMAN EXPOSURE

from stationary sources in the United States for 1969–1971, 1978, and 1983 were 900, 1,240, and 1,560 tons selenium/year, respectively (EPA 1974; Lee and Duffield 1979). Dulka and Risby (1976) estimated yearly releases of selenium to the air from fossil fuel combustion to be 1,000 tons. Harr (1978) estimated that 1,500 tons were released annually, with additional air releases from industrial and municipal wastes totaling 2,700 tons and 360 tons, respectively. Selenium releases to the air are likely to increase as more coal is burned in the future. The estimated selenium emissions from Canadian non-ferrous smelters (stack plus fugitive) were 3.02 tons in 1993 (Skeaff and Dubreuil 1997).

Incineration of rubber tires, paper, and municipal waste is an additional source of atmospheric selenium. Hashimoto et al. (1970) reported selenium concentrations in rubber tires to be 1.3 mg/kg. Seventy different kinds of paper have been found to contain selenium (West 1967). Combustion of municipal solid waste results in stack emissions ranging from 0.00098 to 0.00216 pounds (0.44–0.98 g) of selenium per ton of refuse (Johnson 1970).

The amount of selenium contributed to the air by other sources is not known. Microbial action within the soil may also contribute selenium to the air (Fishbein 1983). Selenium biomethylation volatilizes about 3,000 tons of selenium per year into the atmosphere, which eventually returns to earth in rainfall (NAS 1976a). Volcanic gas is suspected to be the major natural source of atmospheric selenium. Certain plants metabolize inorganic selenium compounds to volatile selenium in the forms of dimethyl selenide (Lewis et al. 1971) and dimethyl diselenide (Evans et al. 1968). Animals are also capable of volatilizing selenium and releasing dimethyl selenide in expired air (Schultz and Lewis 1940).

Fly ash settling ponds (which contain high concentrations of selenium) and hazardous waste sites where selenium compounds were disposed of in the past are potential sources of atmospheric selenium through fugitive dust emissions. Selenium emissions from these potential sources have not been quantified.

According to TRI, an estimated total of at least 65,481 pounds of elemental selenium and 576,929 pounds of selenium compounds were discharged to the air from manufacturing and processing facilities in the United States in 2000 (TRI00 2002) (see Tables 6-1 and 6-2). The data listed in the TRI tables should be used with caution since only certain types of facilities are required to report. This is not an exhaustive list.

Selenium has been identified in air at 13 of the 508 NPL hazardous waste sites where it was detected in some environmental media (HazDat 2003).

6. POTENTIAL FOR HUMAN EXPOSURE

6.2.2 Water

Surface waters can receive selenium from the atmosphere by dry and wet deposition, from adjoining waters that may contain selenium, from surface runoff, and from subsurface drainage. Sewage treatment plants are another source of selenium releases to water. Effluents from sewage treatment plants and oil refineries appear to be the major sources of selenium in the San Francisco estuarine system (Cutter 1989). In a study of direct discharges from oil refineries in San Francisco Bay, the average selenium concentration in the effluent was 0.067 mg/L with a range of 0.0066–0.156 mg/L (Barceloux 1999; Cutter 1989). Approximately 50–76% of the total selenium in the effluents was selenite. This proportion of selenite is higher than that found in natural estuary sources in the San Francisco Bay (Cutter 1989). About 150,000–460,000 tons of selenium per year are deposited in coal fly ash (Andren and Klein 1975; Doran 1982). Selenium from fly ash settling ponds and hazardous waste sites could reach surface water via runoff or could reach groundwater via leaching. Concentrations of 0.10–0.25 mg/L in a settling basin effluent from coal fly ash in North Carolina were reported by Lemly (1985). Overflow from the ash basin of a coal fired electric generating facility to Belews Lake resulted in surface water selenium concentrations of 0.005–0.020 mg/L in the lake basin. These levels have been reduced considerably since 1986 when the discharge of selenium laden waste water to the lake was discontinued. The peak selenium concentration in 1996 was <0.001 mg/L (Lemly 1997). Selenium concentrations as high as 0.28 mg/L have been reported for raw sewage, 0.045 mg/L for primary effluent, and 0.050 mg/L for secondary effluent (Baird et al. 1972). Irrigation drainage from seleniferous soils can increase selenium concentrations in surface water and has resulted in levels that are toxic to wildfowl at Kesterson National Wildlife Refuge in California (Ohlendorf et al. 1986a, 1988). Selenium was found to be released during coal mining because of the oxidation of selenium-bearing pyrite (Dreher and Finkelman 1992).

According to the TRI, an estimated total of 1,019 pounds of elemental selenium and 56,048 pounds of selenium compounds were discharged to surface water from manufacturing and processing facilities in the United States in 2000 (see Tables 6-1 and 6-2). The data listed in the TRI tables should be used with caution since only certain types of facilities are required to report. This is not an exhaustive list.

Selenium has been identified in groundwater at 271 sites and surface water at 106 sites of the 508 NPL hazardous waste sites where it was detected in some environmental media (HazDat 2003).

6. POTENTIAL FOR HUMAN EXPOSURE

6.2.3 Soil

The primary factor that controls selenium concentrations in soil is the selenium content of the parent bedrock materials that release selenium via weathering processes and leaching (NAS 1976a). Natural weathering processes are thought to release about 100,000–200,000 metric tons of selenium per year (Andren and Klein 1975). Atmospheric deposition of selenium also contributes to selenium in the soil. In the past, selenium was used in pesticide products, but because of its stability in soils and subsequent contamination of food crops, its use in pesticide products is now restricted. The release of selenium to soil from fly ash settling ponds and hazardous waste sites has not been quantified.

According to the TRI, an estimated total of 157,521 pounds of elemental selenium and 7,209,933 pounds of selenium compounds were discharged to land from manufacturing and processing facilities in the United States in 2000 (TRI00 2002). In addition, 40,246 pounds of selenium and 27,699 pounds of selenium compounds were injected underground (see Table 6-2). The data listed in the TRI tables should be used with caution since only certain types of facilities are required to report. This is not an exhaustive list.

Selenium has been identified in soil at 188 sites and sediment at 113 of the 508 NPL hazardous waste sites where it was detected in some environmental media (HazDat 2003).

6.3 ENVIRONMENTAL FATE

The behavior of selenium in the environment is influenced to a large degree by its oxidation state and the consequent differences in the behavior of its different chemical compounds (EPA 1979c; NAS 1976a). The oxidation state of selenium in the environment is dependent on ambient conditions, particularly on pH, pE, and biological activity (Maier et al. 1988).

6.3.1 Transport and Partitioning

The volatile selenium compounds that partition into the atmosphere include the inorganic compounds, selenium dioxide and hydrogen selenide, and the organic compounds, dimethyl selenide and dimethyl diselenide. Hydrogen selenide is highly reactive in air and is rapidly oxidized to elemental selenium and water (NAS 1976a), but the other compounds can persist in air.

6. POTENTIAL FOR HUMAN EXPOSURE

Selenium compounds released to the atmosphere can be removed by dry or wet deposition to soils or to surface water. The annual wet deposition rate of selenium at two rural/agricultural sites in Queenstown, Maryland and St. Mary's, Maryland were 287 and 140 $\mu\text{g}/\text{m}^2\text{-year}$, respectively (Scudlark et al. 1994). Selenium concentrations ranging from 0.04 to 1.4 $\mu\text{g}/\text{L}$ have been detected in rain and snow (Hashimoto and Winchester 1967). Kubota and coworkers (1975) reported selenium concentrations of 0.02–0.37 $\mu\text{g}/\text{L}$ in rainwater at several locations in the United States and Denmark. Selenium was detected at average concentrations of 5.60–7.86 $\mu\text{g}/\text{L}$ during four rainfall events in Riyadh, Saudi Arabia (Alabdula'aly and Khan 2000).

The forms of selenium expected to be found in surface water and the water contained in soils are the salts of selenic and selenious acids. Selenic acid (H_2SeO_4) is a strong acid. The soluble selenate salts of this acid are expected to occur in alkaline waters. Sodium selenate is one of the most mobile selenium compounds in the environment because of its high solubility and inability to adsorb onto soil particles (NAS 1976a). Selenious acid (H_2SeO_3) is a weak acid, and the diselenite ion predominates in waters between pH 3.5 and 9. Most selenites are less soluble in water than the corresponding selenates (NAS 1980b).

Selenium in an aquatic environment is bioaccumulated by aquatic organisms (Chau and Riley 1965; Ohlendorf et al. 1986a; Rudd and Turner 1983a; Saiki and Lowe 1987). Lemly (1985) has reported bioconcentration factors (BCFs) of 150–1,850 and bioaccumulation factors (BAFs) of 1,746–3,975 for selenium in freshwater. In the Kesterson National Wildlife Refuge in the San Joaquin Valley of California, elevated levels of selenium have been measured (dry weight) in algae (average 35 mg/kg), midge larvae (139 mg/kg), dragonfly and damselfly nymphs (average 122 and 175 mg/kg, respectively), and mosquito fish (170 mg/kg) (Ohlendorf et al. 1986b). For comparison, the mean concentrations of selenium found in fish throughout the United States in the 1976–1977, 1978–1979, and 1980–1981 National Pesticide Monitoring Program were 0.56, 0.46, and 0.47 mg/kg wet weight, respectively (Lowe et al. 1985; May and McKinney 1981; Ohlendorf et al. 1986b). Similarly, Lemly (1985) found elevated selenium concentrations in aquatic organisms living in a power plant cooling reservoir in North Carolina. The degree of bioaccumulation of selenium exhibited a stable pattern over several years, with selenium concentrations (wet weight) as follows: fish (6–35 mg/kg) > benthic insects (12–15 mg/kg) > annelids (10–12 mg/kg) > molluscs and crustaceans (5–9 mg/kg) > periphyton (4–6 mg/kg) (Ohlendorf et al. 1986a). In fish, selenium was concentrated in visceral tissue (25–35 mg/kg wet weight) more than in skeletal muscle (6–11 mg/kg wet weight). Adams (1976) reported BCFs of 62.1, 14.3, 6.3, 3.2, and

6. POTENTIAL FOR HUMAN EXPOSURE

10.5 for selenium in the viscera, gill, head and tail, muscle, and whole trout, respectively. The BCFs and BAFs for selenium in visceral tissue (i.e., heart, hepatopancreas, spleen, and gonads) of fish have been estimated to range from 35 to 1,850 and from 1,058 to 3,980, respectively (Lemly 1982, 1985). Lemly (1985) also estimated BAFs for selenium in skeletal muscle of fish to range from 485 to 1,746, depending on the species. Maier et al. (1988) estimated selenium BAFs for algae to range from 100 to 2,600, and Besser et al. (1993) estimated BCFs of 16,000 for algae, 200,000 for daphnids, and 5,000 for bluegills from exposures to 1 µg/L selenomethionine. Selenite was more concentrated than selenate for algae and daphnids, whereas bluegills concentrated both inorganic species about equally (Besser et al. 1993). Selenium accumulation from selenomethionine occurred more readily than from selenite or selenate (Besser et al. 1989).

Some evidence indicates that selenium might biomagnify in aquatic organisms under natural conditions (Lemly 1985; Maier et al. 1988; NCDNR 1986; Sandholm et al. 1973). Biomagnification is evidenced by progressively higher concentrations of an element or substance in organisms at successively higher trophic levels. More than 50% of the selenium contained in sediments in the ponds and the reservoir in the Kesterson National Wildlife Refuge in California occurs in organic forms (Maier et al. 1988), resulting from the synthesis and bioaccumulation of organic selenium before the plants die and decay on the bottom.

In soils, pH and Eh are determining factors in the transport and partitioning of selenium. Elemental selenium is essentially insoluble and may represent a major inert "sink" for selenium introduced into the environment under anaerobic conditions (NAS 1976b). Heavy metal selenides and selenium sulfides, which are also insoluble, predominate in acidic (low pH) soils and in soils with high amounts of organic matter. Selenium in this form is immobile and will remain in the soil. The selenides of other metals such as copper and cadmium are of low solubility (NAS 1976b). Sodium and potassium selenites dominate in neutral, well-drained mineral soils, where some soluble metal selenites may be found as well. In alkaline (pH>7.5), well-oxidized soil environments, selenates are the major selenium species. Because of their high solubility and low tendency to adsorb onto soil particles, the selenates are very mobile (Kabatas-Pendias and Pendias 1984) and are readily taken up by biological systems (Klaassen et al. 1986) or leached through the soil. Gerritse et al. (1982) found selenium to be very mobile in sewage sludge leachate. They reported K_d values (distribution coefficient = [concentration of selenium sorbed on soil or rock]/[concentration of selenium in solution]) of 14.9 mL/g for sandy loam and 5.91 mL/g for sludge-treated sandy soils. Selenite forms stable ferric oxide-selenite adsorption complexes in acid or neutral soils (Geering et al. 1968).

6. POTENTIAL FOR HUMAN EXPOSURE

When environments favor the soluble forms of selenium (alkaline and oxidizing conditions), these forms can be accumulated by plants. In addition, although both selenite (Se^{4+}) and selenate (Se^{6+}) are soluble forms of selenium, selenate was found to be the preferred form of selenium taken up by plants (Bañuelos and Meek 1990). Preferential uptake of selenate may be caused by its tendency to be less strongly adsorbed to soil particles and organic matter than selenite (Bañuelos and Meek 1990). Selenium uptake by plants is influenced by many factors including soil type, pH, colloidal content, concentration of organic material, oxidation-reduction potentials in the root-soil environment, and total level of selenium in the soil (Fishbein 1983; Robberecht et al. 1982). In acidic soils (pH 4.5–6.5) and under high moisture conditions, selenium is in the form of selenite and is bound to colloids as iron hydroxide selenium complexes. These complexes are insoluble and generally not bioavailable to plants (Galgan and Frank 1995). In basic soils (pH 7.5–8.5), selenium is present as soluble selenate. Soluble selenates (principally sodium selenate) appear to be responsible for most of the naturally occurring accumulation of high levels of selenium by plants, although much of the total selenium in soil may be present in other forms (NAS 1976a). The use of lime and plant ash as fertilizers, which would raise the pH of the soil and favor the formation of selenate, has been implicated as a contributing factor in the accumulation of selenium in crops grown in high selenium soil found in certain regions of China (Yang et al. 1988).

6.3.2 Transformation and Degradation

6.3.2.1 Air

Selenium dioxide released to the air from the combustion of fossil fuels should be largely reduced to elemental selenium by sulfur dioxide formed during the combustion (NAS 1976b). During a 1991 study, Oehm et al. found that selenium dioxide reacting with atmospheric moisture generates selenious acid aerosols. Hydrogen selenide is unstable in air and is oxidized to elemental selenium and water (NAS 1976a). Hazards from hydrogen selenide are expected, therefore, to be confined to occupational settings where the confined gas might build up to hazardous levels despite oxidative losses (NAS 1976a).

Dimethyl selenide and methyl selenide are volatile organic compounds that can partition into and persist in the atmosphere. Other selenium compounds released to the atmosphere as dust can be removed by wet deposition (in rain or snow) or by dry deposition.

6. POTENTIAL FOR HUMAN EXPOSURE

6.3.2.2 Water

In general, the more soluble and mobile forms of selenium (e.g., selenite and selenate) dominate under aerobic (high oxygen concentrations) and alkaline (high pH) conditions (NAS 1976a; Shamberger 1981). Selenates have been predicted thermodynamically to predominate under aerobic conditions, but a review of the literature indicates that both selenites and selenates are equally common in surface waters (Robberecht and Van Grieken 1982). For selenites in solution, equilibria will be set up between H_2SeO_3 , HSeO_3^- , SeO_3^- , HSe_2O_5^- , and $\text{Se}_2\text{O}_5^{2-}$. The relative concentrations of these species will be determined by the pH of the solution and the total concentration of the electrolytes. Between pH 3.5 and 9, dissolved selenite would be expected to be present predominantly as the diselenite ion, whereas dissolved selenate would occur predominantly as SeO_4^{2-} . Sodium predominates as the counter ion of selenate and selenite in most surface waters.

A study completed by Bender et al. (1991) using a simulated laboratory pond found that bacteria and cyanobacteria have two possible mechanisms for the uptake and transformation of selenate. The uptake mechanism involves the reduction of selenate to elemental selenium that will be physically held within the biological mat. The microorganisms were also found to cause the transformation of soluble selenium into volatile alkyl selenium compounds (Bender et al. 1991).

In some deep aquifers, selenium transport in groundwater was found to be strongly retarded (White et al. 1991). This phenomena is thought to be caused by chemical reduction and precipitation mediated by microbial activity.

Under acidic conditions, selenite can be rapidly reduced to elemental selenium by mild reducing agents such as ascorbic acid or sulfur dioxide (NAS 1980b). Selenate can be converted to selenite or elemental selenium in aquatic systems, but this reaction is slow relative to other transformations. Once formed, elemental selenium is stable over a wide range of pH values and a range of mildly oxidizing to reducing conditions. The formation of various metal selenides is favored by acidic and reducing conditions (NAS 1976b), as found in organic-rich sediments.

Aquatic organisms can convert selenium to both inert and soluble forms. Duckweed, phytoplankton, bacteria, and fungi have been demonstrated to synthesize selenoamino acids from absorbed inorganic selenium compounds (Maier et al. 1988). These selenoamino acids are not likely to be found at significant dissolved concentrations in water, however, because amino acids are rapidly catabolized by

6. POTENTIAL FOR HUMAN EXPOSURE

bacteria. Benthic bacteria and fungi are capable of methylating elemental and inorganic selenium salts (Chau et al. 1976). Hydrogen selenide can be formed in a reducing environment (Cutter 1982; NAS 1976a). Both hydrogen selenide and the methylated forms of selenium are unstable in water and would be expected to rapidly volatilize to the atmosphere (Fishbein 1983).

6.3.2.3 Sediment and Soil

In soils, elemental selenium and inorganic selenium compounds such as sodium selenite can be methylated by microorganisms and subsequently volatilized to the atmosphere (Doran 1982; Fishbein 1983; Shamberger 1981). Microorganisms such as *Aeromonas*, *Flavobacterium*, and *Pseudomonas* are suspected of methylating inorganic and organic selenium compounds to dimethyl selenide and dimethyl diselenide (Doran and Alexander 1976; Fishbein 1983; Reamer and Zoller 1980). Microbes cultured from rhizosphere of bulrush (*Scirpus robustus*) plants were shown to biomethylate soluble selenate and selenite and substantially volatilize these compounds over a 15-day incubation period (Azaizeh et al. 1997). Temperature plays a significant role in the microorganism-mediated volatilization of selenium compounds; temperature reductions from 20 to 10 °C and from 20 to 4 °C resulted in 25 and 90% decreases, respectively, in the dimethyl selenide produced (Chau et al. 1976). Reamer and Zoller (1980) examined microbial transformation of selenium in aerobic sewage contaminated with elemental selenium and selenite. They found dimethyl selenide to be the principal microbial product at low selenite concentrations (1–10 mg/kg), whereas dimethyl diselenide and dimethyl selenone were the principal products at higher selenite concentrations (100–1,000 mg/kg). Dimethyl selenide was the only product recovered from sludge contaminated with elemental selenium (Reamer and Zoller 1980). In general, microorganisms appear to methylate organic selenium compounds more readily than either selenite or selenate (Maier et al. 1988). Elemental selenium is converted to methylated selenium compounds the least rapidly (Maier et al. 1988). Selenium methylation and subsequent return from the atmosphere as selenite in rainwater is likely to be the major natural process by which selenium cycling occurs in the environment (Doran 1982).

Demethylation of the trimethylselenonium ion can also occur in soil. Microorganisms are evidently required for this reaction since it did not occur in autoclaved soil (Yamada et al. 1994). Selenium added to the soil as trimethylselenonium was not recovered in the soil, suggesting that trimethylselenonium was demethylated to gaseous selenium compounds, for example, dimethylselenide.

6. POTENTIAL FOR HUMAN EXPOSURE

Terrestrial plants take up soluble selenate and selenite and biosynthesize organic selenium compounds, predominantly selenomethionine and, to a lesser extent, selenocysteine. Selenates tend to be taken up by plants from soils more readily than selenites, in part because selenites tend to adsorb more strongly to soils (Dimes et al. 1988; Zhang et al. 1988). These compounds can be released to the soils once the plants die and decay. Water-soluble organic selenium compounds are also probably readily taken up by plants (Shamberger 1981; Shrift 1964).

6.4 LEVELS MONITORED OR ESTIMATED IN THE ENVIRONMENT

Selenium can be detected in most biological and nonbiological materials in the environment. Selenium occurs in aquatic and terrestrial organisms as well as in water, air, and soil. Among foods consumed by humans, meat products generally contain the highest concentration of selenium while vegetables and fruits contain the lowest. Brazil nuts contain extremely high levels of selenium since they grow in the foothills of the Andes Mountains, where the soils are high in selenium (Secor and Lisk 1989). Cereals contain intermediate levels of selenium.

6.4.1 Air

Background ambient air concentrations of selenium are generally in the ng/m^3 range (Harrison et al. 1971; John et al. 1973; Peirson et al. 1973). Dams et al. (1970) found concentrations of selenium in suspended air particulate matter of 2.5 ng/m^3 in Niles, Michigan, and 3.8 ng/m^3 in East Chicago, Indiana. During 1968–1969, 18 air samples collected around Buffalo, New York, showed a range of $3.7\text{--}9.7 \text{ ng/m}^3$ (Pillay et al. 1971). Based on these results, the National Academy of Sciences (NAS 1976a) has estimated that the average selenium concentration in the air is well below 10 ng/m^3 . A monitoring study to determine the seasonal variation of pollutants in the air of Alaska was conducted from 1984 to 1987 (Sturges and Shaw 1993). The average concentrations of selenium in Poker Flats, Alaska were 0.035 ng/m^3 (June 1 through January 31, 1984–1987) and 0.067 ng/m^3 (February 1 through May 31, 1984–1987). The nearly 2-fold increase in concentration during the spring months were attributed to local marine biogenic volatilization of selenium, and not a coal burning origin (Sturges and Shaw 1993). Selenium was detected in the ambient atmosphere at seven sites in the United Kingdom at concentrations ranging from 0.1 to 42.3 ng/m^3 (Lee et al. 1994). The lowest levels were observed in the rural areas of Chilton and Windermere with mean concentrations of 1.3 and 0.9 ng/m^3 , respectively. The highest mean concentration of 16.7 ng/m^3 was observed in the industrial area of Walsall.

6. POTENTIAL FOR HUMAN EXPOSURE

6.4.2 Water

Selenium has been detected in surface waters and groundwaters in the United States at generally low concentrations. Selenium has been detected in oceans at an average value of 9×10^{-5} mg/L (0.09 μ g selenium/L) (Schutz and Turekiam 1965). In a study of selenium concentrations in major watersheds of the United States, selenium was detected in only 2 of 535 samples (<0.5%) at a concentration greater than the lowest detection limit of 0.010 mg/L (Lakin and Davidson 1967). Examination of the EPA STORET database for the state of North Carolina revealed that only 3.3% of 657 samples of surface water contained more than 0.001 mg/L, and the highest value was 0.012 mg/L (NCDNR 1986). Watersheds that receive selenium-contaminated waste water have high levels of selenium in surface water samples. The selenium concentration in Lake Belews, North Carolina has dropped from a maximum value of about 0.020 mg/L (pre -1986) to <0.001 mg/L in 1996, due to the discontinued release of selenium laden waste water from a local coal fired power plant (Lemly 1997). The selenium concentration in portions of Pigeon River and Pigeon Lake, Michigan which receive waste water input from a coal fly ash disposal facility, were <0.001–0.0075 mg/L (Besser et al. 1996).

High selenium levels are more likely to be found in irrigation return waters, seeps, springs, and shallow wells where seleniferous soils may contribute to the selenium content of the water. Glover et al. (1979) found that under unusual geological conditions, selenium concentrations in groundwater may reach 0.60 mg/L. In another study conducted in a seleniferous area of South Dakota, 34 of 44 wells did not show any measurable selenium; however, the remaining 10 had concentrations ranging from 0.050 to 0.339 mg/L (Smith and Westfall 1937). Selenium concentrations determined in 107 irrigation and 44 livestock well waters in the San Joaquin area of California exceeded 0.010 mg/L in 26 wells, but exceeded 0.020 mg/L in only 11 wells (Oster et al. 1988a). The maximum concentration was 0.272 mg/L (Oster et al. 1988a).

Selenium accumulation in agricultural drainage waters and basins has been documented in the western United States, particularly in California. The problem was first discovered in the Kesterson Wildlife Refuge in the San Joaquin Valley of California. In 1975, the U.S. Bureau of Reclamation finished construction of an 85-mile subsurface agricultural water drain that terminated in a series of evaporation ponds called Kesterson Reservoir. By 1983, however, it was confirmed that the drain waters contained high concentrations of selenium (>1.35 mg/L in some areas) leached from the soil by application of

6. POTENTIAL FOR HUMAN EXPOSURE

irrigation water (Maier et al. 1988). Because the high selenium levels produced death and deformities in fish and waterfowl, delivery of subsurface water to Kesterson was terminated in 1986 (Lewis 1988). Measurements of trace elements in the 27 other evaporation basins in the San Joaquin Valley have revealed only 3 basins with total selenium exceeding 0.10 mg/L and only 50 acres of evaporation basin cells with selenium concentrations in excess of 1.0 mg/L (CRWQCB 1988).

6.4.3 Sediment and Soil

Selenium is estimated to be the 69th most abundant element in the earth's crust, with an average concentration of 0.05–0.09 mg/kg (Glover et al. 1979). Chemically, selenium closely resembles sulfur. Consequently, sulfides of bismuth, iron, mercury, silver, copper, lead, and zinc have been found to contain selenium (Shamberger 1981). Selenium is concentrated in the sulfide minerals galena, chalcopyrite, arsenopyrite, sphalerite, pyrite, marcasite, and pyrrhotite (Coleman and Delevaux 1957). Jarosite and barite have also been found to contain selenium at low levels. The sulfides containing the highest selenium concentrations are those associated with uranium ores in sandstone-type deposits in the western United States. In the immediate vicinity of sandstone-type uranium deposits, selenium concentrations as high as 1,000 mg/kg have been found (Shamberger 1981). Hydrothermal ore is also known to contain high concentrations of selenium. The best known are epithermal gold, silver, antimony, and mercury deposits (Shamberger 1981). Selenium has been found in volcanic rocks in the western United States at concentrations as high as 120 mg/kg (Glover et al. 1979).

Various studies estimated selenium concentration of most soils to be between 0.01 and 0.2 mg/kg (Sindeeva 1964). One study analyzed several thousand soil samples in the United States and found that most seleniferous soils contained <2 mg/kg, with a maximum concentration of <100 mg/kg (Rosenfeld and Beath 1964). The highest U.S. soil levels of selenium are found in areas of the West and Midwest.

Atmospheric deposition of selenium from mining and smelting activities also appears to be a source to soils and plants (Glooschenko and Arafa 1988). In this study, an indirect relationship between distance from smelters and selenium concentration was shown using *Sphagnum fuscum* as an indicator. Washout of atmospheric selenium by precipitation appeared to be the primary mechanism for accumulating selenium in soils and plants in the vicinity of smelters (Glooschenko and Arafa 1988).

6. POTENTIAL FOR HUMAN EXPOSURE

Sandstone has been found to contain selenium in varying concentrations, but most probably contains <1 mg/kg (Rosenfeld and Beath 1964). However, sandstone in Wyoming has been found to contain >100 mg/kg (Beath et al. 1946). Generally, the selenium concentration of limestone is low; however, shales of the Niobrara formation in South Dakota have been found to contain over 40 mg/kg. The range of selenium concentrations in phosphate rocks is <1–300 mg/kg (NAS 1976a). Shales appear to contain consistently higher concentrations of selenium than limestone or sandstone. Despite the fact that shales vary so widely in their selenium concentration, they are fairly reliable indicators of soils high in selenium (NAS 1976a).

The disposal of selenium contaminated waste water has resulted in elevated selenium levels in sediments of Lake Belews, North Carolina. The concentration of selenium in sediments ranged from 4 to 12 µg/g (pre-1986), but has dropped to 1–4 µg/g (1996) due to the discontinued release of selenium laden waste water from a local coal fired power plant (Lemly 1997). Selenium was measured in 445 surface soil samples from Florida with a concentration range of 0.01–4.62 µg/g and an arithmetic mean of 0.25 µg/g (Chen et al. 1999). Selenium was detected in soils and bed sediment from the South Platter River Basin at concentrations of 0.30–3.80 µg/g (Heiny and Tate 1997). The highest levels were observed in areas consisting of a high degree of Precambrian rock formation.

6.4.4 Other Environmental Media

Coal and Oil. Petroleum has been found to contain 500–950 mg/kg crude petroleum and 500–1,650 mg/kg heavy petroleum (Hashimoto et al. 1970). An average of 2.8 mg/kg coal has been reported for 138 samples from U.S. deposits (Pillay et al. 1969).

Plants. Several species of grasses and herbaceous plants accumulate selenium, and some of these are endemic to the western United States. Primary accumulators are *Astragalus*, *Oonopsis*, *Stanelya*, *Xylorhiza*, and *Machaeranthera*. Secondary accumulators are *Astor*, *Gatierreaia*, *Atriplex*, *Grindelia*, *Castillaja*, and *Comandra*. Primary accumulators can contain 100–100,000 mg/kg of plant tissue, whereas secondary accumulators contain 25–100 mg/kg of plant tissue (dry weight). Nonaccumulator plants generally contain less than 25 mg of selenium/kg of plant tissue (dry weight) (Rosenfeld and Beath 1964). In some plants, including the leaves of beets and cabbage, and in garlic, as much as 40–50% of the selenium may be in the form of selenate (Cappon 1981).

6. POTENTIAL FOR HUMAN EXPOSURE

A study by Arthur et al. (1992) showed an increased uptake of selenium by terrestrial plants growing on soil-capped fly ash landfill sites. Selenium concentrations rarely exceeded 5 mg/kg, and there were no signs of selenium toxicity to plants. A similar study by Shane et al. (1988) on greenhouse vegetables established that the uptake of selenium by these vegetables is proportional to the percentage of selenium in the growth medium. Another greenhouse study showed that four floating aquatic plants, *Azolla caroliniana*, *Eichjornia crassipes*, *Salvinia rotundifolia*, and *Lemna minor*, absorbed selenium quickly upon exposure (Horne 1991).

Animals. Aquatic animals accumulate selenium from lakes and rivers high in selenium content. Fish in the Kesterson National Wildlife Refuge in California had selenium concentrations up to 96 mg/kg, and aquatic birds had levels up to 130 mg/kg (Barceloux 1999). Selenium was detected in fish from three sites of the Pigeon River and Pigeon Lake in Michigan (Besser et al. 1996). It was determined that selenium concentrations in fish at sites receiving seepage and effluents from a coal fly ash disposal facility were considerably higher than for fish upstream from the facility. Mean concentrations of selenium in white sucker and northern pike ranged from 0.46 to 0.88 µg/g in an uncontaminated portion of the river, while concentrations in a contaminated portion of the river and lake were 1.1–2.4 µg/g (Besser et al. 1996). The mean concentrations of selenium in the feathers of five species of birds at Clear Lake, California were 3.20 µg/g (osprey), 1.38 µg/g (western grebe), 2.51 µg/g (great blue heron), 0.94 µg/g (turkey vulture), and 1.05 µg/g (mallard) (Cahill et al. 1998). Ospreys (which consume large mature fish) had the highest selenium levels, while turkey vultures (which rarely interact with the contaminated aquatic system) and mallards (which are semi-domesticated) had the lowest levels. Selenium was observed in 24 of 24 black-crowned night herons from the Delaware Bay at concentrations of 2.84–5.95 µg/g (Rattner et al. 2000). The highest levels were observed in herons from Pea Patch Island, an island adjacent to a shipping channel for the petrochemical industry. Selenium was observed in the liver of 70 out of 70 redheads (*Athya americana*) in Louisiana and Texas at concentrations of 1.56–5.86 µg/g (Michot et al. 1994). The selenium concentration in moose liver from 12 areas of Sweden ranged from 0.0027 to 3.054 µg/g (Galgan and Frank 1995). The highest levels were observed in areas with a high degree of selenium deposition from industrial sources.

Food. In a review of the foods that contribute the highest proportion of the daily selenium intake of human populations in the United States, Schubert et al. (1987) estimated selenium concentrations in over 100 food items on the basis of 65 articles published after 1960. Table 6-3 presents the selenium concentrations for some of the food items analyzed. The quality of the data was evaluated on the basis of sample size, analytic method, sample handling, sampling plan, and analytic quality control. Schubert et

6. POTENTIAL FOR HUMAN EXPOSURE

**Table 6-3. Selenium Concentrations in Foods in the United States^a
(mg selenium/kg, wet weight)**

Food item	Average	Minimum	Maximum	Number of acceptable samples
Fruits and vegetables				
Apples, raw	0.004	0.003	0.006	5
Carrots, raw	0.017	0.006	0.029	5
Oranges	0.015	0.013	0.018	3
Potatoes	0.013	0.004	0.023	7
Grains, nuts, and cereals				
Bread, white	0.32	0.23	0.54	6
Bread, whole wheat	0.44	0.28	0.67	3
Corn flakes	0.063	0.026	0.12	4
Special K	0.063	0.35	0.94	4
Egg noodles, dry	0.66	0.43	1.35	7
Egg noodles, cooked	0.19	0.14	0.42	2
Nuts, Brazil ^b	14.7	0.20	253	72
Dairy products				
Whole milk	0.016	0.011	0.025	4
Swiss cheese	0.083	0.062	0.10	2
Cottage cheese	0.060	0.052	0.068	2
Meat				
Chicken, cooked	0.21	0.17	0.26	2
Beef, cooked	0.26	0.15	0.52	3
Pork/ham, fresh/cured	0.33	0.19	0.51	6
Salami	0.20	0.13	0.33	2
Seafood^c				
Salmon, canned	0.75	0.31	1.49	3
Shrimp, canned/cooked	0.64	0.21	1.61	4
Swordfish	2.84	2.54	3.44	4
Organ meats				
Beef liver, cooked	0.56	0.43	0.71	2
Beef kidney, raw	1.70	1.45	2.32	4

^aFood is the normal source of selenium which is essential for human health. Concentrations from Schubert et al. (1987), except where noted.

^bSecor and Lisk (1989)

^cBioavailability of selenium from some fish may be lower than from other foods.

6. POTENTIAL FOR HUMAN EXPOSURE

al. (1987) chose not to present standard deviations or standard errors of the samples because of the different sampling biases present in the studies.

In general, fruits and vegetables were found to contain <0.01 mg/kg, whereas root vegetables contained higher concentrations of selenium (Table 6-3). Beale et al. (1990) found milk and meat to have the same range of selenium concentrations as Schubert et al. (1987). In another study, no apparent correlation existed between the selenium concentration of canned versus fresh fruits and vegetables (Morris and Levander 1970).

Grain products varied greatly in their selenium concentration. Wheat bread and flour were high in selenium, whereas white bread and white flour contained considerably less selenium. Very low levels of selenium were found in certain processed cereals, such as corn flakes, but not in others, such as oat cereal (Morris and Levander 1970; Schubert et al. 1987).

Dairy products contained variable concentrations of selenium as well, but, in general, contained lower levels than meat products. Organ meats (e.g., liver and kidney) and seafoods contained higher levels of selenium than poultry or beef (Morris and Levander 1970; Schubert et al. 1987). The U.S. Fish and Wildlife Service collected 315 whole fish samples from 109 stations nationwide and analyzed them for selenium. Selenium concentrations were as follows (wet weight): geometric mean of 0.42 µg/g, maximum of 2.3 µg/g, and 85th percentile concentration of 0.73 µg/g (Schmitt and Brumbagh 1990). Consumption of the foods with higher selenium levels contributes to the daily intake of adequate amounts of selenium.

Analysis of commercial baby foods indicated that processing may reduce selenium levels of the food (Morris and Levander 1970).

A recent survey conducted by the U.S. Food and Drug Administration (FDA), which analyzed foods consumed in the United States during the period of 1991–1999, detected selenium in 3,654 out of 6,679 food samples analyzed (FDA 2000). The results of this survey are summarized in Table 6-4.

6. POTENTIAL FOR HUMAN EXPOSURE

Table 6-4. U.S. Food and Drug Administration—Total Diet Study (TDS)—Market Baskets 91-3 through 99-1

Selenium—summary of results									
TDS food description	TDS food number	Number of results	Number of not detected	Number of traces	Mean (mg/kg)	Standard deviation (mg/kg)	Minimum (mg/kg)	Maximum (mg/kg)	Median (mg/kg)
	Overall:	6,671	3,025	1,206	0.07	0.12	0	1.8	0.017
Whole milk, fluid	1	25	5	18	0.019	0.012	0	0.044	0.02
Lowfat (2% fat) milk, fluid	2	25	6	14	0.022	0.015	0	0.056	0.025
Chocolate milk, fluid	3	25	5	15	0.021	0.014	0	0.054	0.023
Skim milk, fluid	4	25	5	14	0.024	0.016	0	0.058	0.025
Plain yogurt, lowfat	6	25	5	9	0.031	0.019	0	0.068	0.033
Chocolate milk shake, fast-food	7	25	5	17	0.023	0.014	0	0.051	0.026
Evaporated milk, canned	8	25	4	4	0.043	0.024	0	0.102	0.047
American, processed cheese	10	25	0	3	0.183	0.025	0.097	0.231	0.178
Cottage cheese, 4% milkfat	11	25	2	4	0.083	0.039	0	0.178	0.08
Cheddar cheese	12	25	0	4	0.198	0.045	0.1	0.318	0.194
Ground beef, pan-cooked	13	25	0	1	0.197	0.052	0.127	0.333	0.187
Beef chuck roast, baked	14	25	0	0	0.251	0.058	0.15	0.379	0.24
Beef steak, loin, pan-cooked	16	25	0	1	0.256	0.063	0.13	0.439	0.24
Ham, baked	17	25	0	1	0.29	0.077	0.12	0.42	0.278
Pork chop, pan-cooked	18	25	0	0	0.46	0.16	0.245	0.808	0.448
Pork sausage, pan-cooked	19	25	0	4	0.215	0.094	0.066	0.556	0.207
Pork bacon, pan-cooked	20	25	0	0	0.38	0.15	0.186	0.836	0.323
Pork roast, baked	21	25	0	1	0.34	0.11	0.13	0.692	0.333

6. POTENTIAL FOR HUMAN EXPOSURE

Table 6-4. U.S. Food and Drug Administration—Total Diet Study (TDS)—Market Baskets 91-3 through 99-1

Selenium—summary of results									
TDS food description	TDS food number	Number of results	Number of not detected	Number of traces	Mean (mg/kg)	Standard deviation (mg/kg)	Minimum (mg/kg)	Maximum (mg/kg)	Median (mg/kg)
Lamb chop, pan-cooked	22	25	0	2	0.25	0.13	0.095	0.74	0.22
Chicken, fried (breast, leg, and thigh) homemade	24	25	0	2	0.25	0.1	0.067	0.465	0.243
Turkey breast, roasted	26	25	0	0	0.34	0.14	0.095	0.583	0.329
Liver, beef, fried	27	25	0	0	0.65	0.25	0.089	1.22	0.67
Frankfurters, beef, boiled	28	25	2	3	0.098	0.037	0	0.155	0.102
Bologna, sliced	29	25	0	5	0.134	0.037	0.07	0.239	0.13
Salami, sliced	30	25	0	3	0.202	0.046	0.079	0.313	0.197
Tuna, canned in oil	32	26	0	0	0.69	0.13	0.498	1.013	0.655
Fish sticks, frozen, heated	34	26	0	1	0.168	0.035	0.076	0.257	0.171
Eggs, scrambled	35	26	0	1	0.217	0.073	0.076	0.405	0.206
Eggs, fried	36	25	0	0	0.278	0.084	0.149	0.454	0.259
Eggs, boiled	37	25	0	2	0.27	0.1	0.023	0.477	0.274
Pinto beans, dry boiled	38	25	2	6	0.076	0.043	0	0.13	0.064
Pork and beans, canned	39	25	5	10	0.034	0.023	0	0.076	0.038
Lima beans, immature, frozen, boiled	42	25	17	8	0.005	0.009	0	0.036	0
Green peas, fresh/frozen, boiled	46	25	18	5	0.007	0.013	0	0.044	0
Peanut butter, smooth	47	25	2	8	0.086	0.068	0	0.271	0.073
Peanuts, dry roasted	48	25	5	5	0.075	0.068	0	0.272	0.063

6. POTENTIAL FOR HUMAN EXPOSURE

Table 6-4. U.S. Food and Drug Administration—Total Diet Study (TDS)—Market Baskets 91-3 through 99-1

Selenium—summary of results									
TDS food description	TDS food number	Number of results	Number of not detected	Number of traces	Mean (mg/kg)	Standard deviation (mg/kg)	Minimum (mg/kg)	Maximum (mg/kg)	Median (mg/kg)
White rice, cooked	50	25	3	4	0.057	0.035	0	0.17	0.055
Oatmeal, quick (1–3 minutes), cooked	51	25	2	4	0.058	0.034	0	0.18	0.052
Wheat cereal, farina, quick (1–3 minutes), cooked	52	25	3	3	0.076	0.047	0	0.205	0.069
Corngrits, regular, cooked	53	25	6	13	0.025	0.025	0	0.095	0.019
Corn, fresh/frozen, boiled	54	25	17	6	0.007	0.012	0	0.034	0
Cream style corn, canned	56	25	18	7	0.005	0.008	0	0.029	0
Popcorn, popped in oil	57	26	5	7	0.083	0.071	0	0.267	0.073
White bread	58	25	0	3	0.211	0.075	0.05	0.363	0.197
White roll	59	25	0	0	0.265	0.076	0.144	0.41	0.266
Cornbread, homemade	60	25	1	3	0.124	0.04	0	0.194	0.123
Biscuit, from refrigerated dough, baked	61	24	0	3	0.127	0.038	0.073	0.22	0.119
Whole wheat bread	62	25	0	0	0.32	0.079	0.198	0.48	0.32
Tortilla, flour	63	25	0	1	0.227	0.099	0.032	0.469	0.229
Rye bread	64	25	0	0	0.26	0.061	0.155	0.4	0.246
Blueberry muffin, commercial	65	25	0	3	0.113	0.04	0.065	0.246	0.108
Saltine crackers	66	26	1	5	0.098	0.036	0	0.197	0.1
Corn chips	67	25	5	8	0.04	0.032	0	0.099	0.034
Pancake from mix	68	25	0	5	0.136	0.074	0.05	0.39	0.129

6. POTENTIAL FOR HUMAN EXPOSURE

Table 6-4. U.S. Food and Drug Administration—Total Diet Study (TDS)—Market Baskets 91-3 through 99-1

Selenium—summary of results									
TDS food description	TDS food number	Number of results	Number of not detected	Number of traces	Mean (mg/kg)	Standard deviation (mg/kg)	Minimum (mg/kg)	Maximum (mg/kg)	Median (mg/kg)
Egg noodles, boiled	69	25	0	1	0.218	0.082	0.052	0.373	0.232
Macaroni, boiled	70	26	0	1	0.242	0.087	0.034	0.43	0.245
Corn flakes	71	26	5	4	0.057	0.048	0	0.195	0.05
Fruit-flavored, sweetened cereal	72	25	0	5	0.075	0.026	0.031	0.14	0.079
Shredded wheat cereal	73	26	7	5	0.046	0.04	0	0.13	0.044
Raisin bran cereal	74	26	5	9	0.049	0.059	0	0.297	0.035
Crisped rice cereal	75	25	1	10	0.085	0.071	0	0.216	0.044
Granola cereal	76	26	0	2	0.144	0.053	0.066	0.244	0.14
Oat ring cereal	77	26	1	0	0.23	0.078	0	0.335	0.235
Apple, red, raw	78	26	25	1	0	0.002	0	0.011	0
Orange, raw	79	26	24	2	0.001	0.003	0	0.012	0
Banana, raw	80	26	16	8	0.009	0.014	0	0.054	0
Watermelon, raw	81	26	25	1	0	0.002	0	0.012	0
Peach, raw	83	26	25	1	0	0.002	0	0.012	0
Applesauce, bottled	84	26	26	0	0	0	0	0	0
Pear, raw	85	26	26	0	0	0	0	0	0
Strawberries, raw	86	25	23	2	0.001	0.003	0	0.012	0
Fruit cocktail, canned in heavy syrup	87	26	26	0	0	0	0	0	0
Grapes, red/green, seedless, raw	88	26	26	0	0	0	0	0	0
Cantaloupe, raw	89	26	16	10	0.007	0.009	0	0.025	0
Plums, raw	91	26	25	1	0	0.002	0	0.012	0

6. POTENTIAL FOR HUMAN EXPOSURE

Table 6-4. U.S. Food and Drug Administration—Total Diet Study (TDS)—Market Baskets 91-3 through 99-1

Selenium—summary of results									
TDS food description	TDS food number	Number of results	Number of not detected	Number of traces	Mean (mg/kg)	Standard deviation (mg/kg)	Minimum (mg/kg)	Maximum (mg/kg)	Median (mg/kg)
Grapefruit, raw	92	26	24	2	0.001	0.003	0	0.011	0
Pineapple, canned in juice	93	26	25	1	0.001	0.003	0	0.017	0
Sweet cherries, raw	94	20	20	0	0	0	0	0	0
Raisins, dried	95	25	24	1	0.001	0.003	0	0.014	0
Prunes, dried	96	25	25	0	0	0	0	0	0
Avocado, raw	97	25	24	1	0.001	0.006	0	0.028	0
Orange juice, from frozen concentrate	98	25	24	2	0.001	0.003	0	0.015	0
Apple juice, bottled	99	25	24	1	0.002	0.008	0	0.04	0
Grapefruit juice, from frozen concentrate	100	26	26	0	0	0	0	0	0
Prune juice, bottled	103	26	25	1	0	0.002	0	0.011	0
Lemonade, from frozen concentrate	105	26	25	0	0.002	0.009	0	0.047	0
Spinach, fresh/frozen, boiled	107	25	18	7	0.003	0.005	0	0.015	0
Collards, fresh/frozen	108	25	17	7	0.005	0.009	0	0.041	0
Iceberg lettuce, raw	109	26	24	2	0.001	0.004	0	0.014	0
Cabbage, fresh, boiled	110	26	21	4	0.003	0.007	0	0.03	0
Coleslaw with dressing, homemade	111	26	17	8	0.011	0.016	0	0.047	0
Sauerkraut, canned	112	26	14	11	0.009	0.015	0	0.071	0

6. POTENTIAL FOR HUMAN EXPOSURE

Table 6-4. U.S. Food and Drug Administration—Total Diet Study (TDS)—Market Baskets 91-3 through 99-1

Selenium—summary of results									
TDS food description	TDS food number	Number of results	Number of not detected	Number of traces	Mean (mg/kg)	Standard deviation (mg/kg)	Minimum (mg/kg)	Maximum (mg/kg)	Median (mg/kg)
Broccoli, fresh/frozen, boiled	113	26	16	8	0.011	0.027	0	0.134	0
Celery, raw	114	26	24	2	0.001	0.003	0	0.012	0
Asparagus, fresh/frozen, boiled	115	26	5	11	0.042	0.045	0	0.217	0.034
Cauliflower, fresh/frozen, boiled	116	26	17	7	0.009	0.022	0	0.103	0
Tomato, red, raw	117	25	22	3	0.002	0.005	0	0.019	0
Tomato sauce, plain, bottled	119	26	23	3	0.003	0.008	0	0.037	0
Green beans, fresh/frozen, boiled	121	26	23	3	0.001	0.004	0	0.013	0
Cucumber, raw	123	26	25	1	0	0.002	0	0.011	0
Summer squash, fresh/frozen, boiled	124	26	22	4	0.002	0.005	0	0.019	0
Green pepper, raw	125	26	26	0	0	0	0	0	0
Winter squash, fresh/frozen, baked, mashed	126	26	24	2	0.001	0.003	0	0.012	0
Onion, mature, raw	128	26	18	8	0.006	0.01	0	0.039	0
Radish, raw	132	26	25	1	0	0.002	0	0.011	0
French fries, frozen, heated	134	26	25	1	0.001	0.003	0	0.016	0
Mashed potatoes, from flakes	135	26	21	5	0.004	0.009	0	0.035	0
White potato, boiled without skin	136	26	25	1	0.001	0.005	0	0.028	0

6. POTENTIAL FOR HUMAN EXPOSURE

Table 6-4. U.S. Food and Drug Administration—Total Diet Study (TDS)—Market Baskets 91-3 through 99-1

Selenium—summary of results									
TDS food description	TDS food number	Number of results	Number of not detected	Number of traces	Mean (mg/kg)	Standard deviation (mg/kg)	Minimum (mg/kg)	Maximum (mg/kg)	Median (mg/kg)
White potato, baked with skin	137	26	20	6	0.004	0.007	0	0.02	0
Potato chips	138	26	13	8	0.026	0.046	0	0.217	0.006
Scalloped potatoes, homemade	139	26	14	10	0.012	0.015	0	0.048	0
Sweet potato, fresh, baked	140	26	22	3	0.004	0.009	0	0.033	0
Spaghetti with tomato sauce and meatballs, homemade	142	26	0	4	0.123	0.035	0.048	0.2	0.116
Beef stew with potatoes, carrots, and onion, homemade	143	26	1	5	0.07	0.026	0	0.12	0.071
Macaroni and cheese, from box mix	146	26	0	2	0.195	0.055	0.076	0.339	0.189
Quarter-pound hamburger on bun, fast-food	147	26	0	2	0.177	0.046	0.091	0.3	0.173
Meatloaf, homemade	148	26	0	2	0.191	0.048	0.074	0.3	0.195
Spaghetti with tomato sauce, canned	149	26	0	6	0.106	0.028	0.06	0.187	0.1
Lasagna with meat, homemade	151	26	0	4	0.147	0.032	0.093	0.213	0.147
Chicken potpie, frozen, heated	152	26	3	3	0.071	0.032	0	0.127	0.076

6. POTENTIAL FOR HUMAN EXPOSURE

Table 6-4. U.S. Food and Drug Administration—Total Diet Study (TDS)—Market Baskets 91-3 through 99-1

Selenium—summary of results									
TDS food description	TDS food number	Number of results	Number of not detected	Number of traces	Mean (mg/kg)	Standard deviation (mg/kg)	Minimum (mg/kg)	Maximum (mg/kg)	Median (mg/kg)
Chicken noodle soup, canned, condensed, prepared with water	155	26	5	9	0.028	0.018	0	0.06	0.03
Tomato soup, canned, condensed, prepared with water	156	26	22	4	0.002	0.005	0	0.017	0
Vegetable beef soup, canned, condensed, prepared with water	157	26	11	15	0.01	0.01	0	0.026	0.013
White sauce, homemade	160	26	6	6	0.032	0.022	0	0.076	0.035
Dill cucumber pickles	161	26	24	2	0.001	0.004	0	0.017	0
Margarine, stick, regular (salted)	162	25	24	1	0	0.002	0	0.012	0
Butter, regular (salted)	164	26	21	5	0.003	0.007	0	0.021	0
Mayonnaise, regular, bottled	166	26	11	12	0.021	0.021	0	0.078	0.024
Half & half cream	167	26	6	18	0.019	0.013	0	0.042	0.021
Cream substitute, frozen	168	26	26	0	0	0	0	0	0
White sugar, granulated	169	26	26	0	0	0	0	0	0
Pancake syrup	170	26	26	0	0	0	0	0	0
Honey	172	26	26	0	0	0	0	0	0
Tomato catsup	173	26	22	4	0.002	0.005	0	0.016	0

6. POTENTIAL FOR HUMAN EXPOSURE

Table 6-4. U.S. Food and Drug Administration—Total Diet Study (TDS)—Market Baskets 91-3 through 99-1

Selenium—summary of results									
TDS food description	TDS food number	Number of results	Number of not detected	Number of traces	Mean (mg/kg)	Standard deviation (mg/kg)	Minimum (mg/kg)	Maximum (mg/kg)	Median (mg/kg)
Chocolate pudding, from instant mix	175	26	6	15	0.027	0.024	0	0.087	0.025
Vanilla flavored light ice cream	177	24	6	10	0.026	0.016	0	0.046	0.03
Chocolate cake with chocolate icing, commercial	178	26	6	11	0.035	0.022	0	0.077	0.041
Yellow cake with white icing, prepared from cake and icing mixes	179	26	7	5	0.035	0.024	0	0.075	0.042
Sweet roll/Danish, commercial	182	26	0	5	0.128	0.04	0.043	0.22	0.123
Chocolate chip cookies, commercial	183	26	6	5	0.043	0.032	0	0.123	0.045
Sandwich cookies with creme filling, commercial	184	26	5	15	0.032	0.022	0	0.081	0.029
Apple pie, fresh/frozen, commercial	185	26	17	9	0.007	0.011	0	0.033	0
Pumpkin pie, fresh/frozen, commercial	186	26	6	11	0.033	0.021	0	0.076	0.037
Milk chocolate candy bar, plain	187	26	4	4	0.046	0.025	0	0.11	0.047
Caramel candy	188	26	10	15	0.017	0.015	0	0.05	0.022
Gelatin dessert, any flavor	190	26	25	1	0.001	0.003	0	0.017	0

6. POTENTIAL FOR HUMAN EXPOSURE

Table 6-4. U.S. Food and Drug Administration—Total Diet Study (TDS)—Market Baskets 91-3 through 99-1

Selenium—summary of results									
TDS food description	TDS food number	Number of results	Number of not detected	Number of traces	Mean (mg/kg)	Standard deviation (mg/kg)	Minimum (mg/kg)	Maximum (mg/kg)	Median (mg/kg)
Cola carbonated beverage	191	26	25	1	0.001	0.003	0	0.014	0
Fruit drink, from powder	193	26	25	0	0.001	0.006	0	0.032	0
Low-calorie cola carbonated beverage	194	26	26	0	0	0	0	0	0
Coffee, decaffeinated, from instant	196	26	24	2	0.001	0.006	0	0.032	0
Tea, from tea bag	197	26	25	1	0.001	0.006	0	0.032	0
Beer	198	26	21	5	0.002	0.005	0	0.015	0
Dry table wine	199	26	24	2	0.002	0.008	0	0.04	0
Whiskey	200	26	25	1	0	0.001	0	0.007	0
Tap water	201	26	25	1	0	0	0	0.002	0
Milk-based infant formula, high iron, ready-to-feed	202	25	6	18	0.017	0.011	0	0.03	0.021
Milk-based infant formula, low iron, ready-to-feed	203	25	6	18	0.018	0.011	0	0.037	0.021
Beef, strained/junior	205	26	6	12	0.028	0.02	0	0.075	0.026
Chicken, strained/junior, with/without broth or gravy	207	25	0	1	0.129	0.024	0.063	0.181	0.134

6. POTENTIAL FOR HUMAN EXPOSURE

Table 6-4. U.S. Food and Drug Administration—Total Diet Study (TDS)—Market Baskets 91-3 through 99-1

Selenium—summary of results									
TDS food description	TDS food number	Number of results	Number of not detected	Number of traces	Mean (mg/kg)	Standard deviation (mg/kg)	Minimum (mg/kg)	Maximum (mg/kg)	Median (mg/kg)
Chicken/turkey with vegetables, high/lean meat, strained/junior	208	2	0	2	0.064	0.004	0.061	0.066	0.064
Beef with vegetables, high/lean meat, strained/junior	209	2	2	0	0	0	0	0	0
Ham with vegetables, high/lean meat, strained/junior	210	2	0	2	0.102	0.033	0.079	0.125	0.102
Vegetables and beef, strained/junior	211	25	14	11	0.007	0.009	0	0.033	0
Vegetables and chicken, strained/junior	212	26	7	19	0.015	0.015	0	0.073	0.012
Vegetables and ham, strained/junior	213	26	7	18	0.016	0.012	0	0.041	0.018
Chicken noodle dinner, strained/junior	214	26	6	10	0.029	0.018	0	0.064	0.032
Macaroni, tomatoes, and beef, strained/junior	215	26	5	10	0.028	0.017	0	0.06	0.032
Turkey and rice, strained/junior	216	26	7	14	0.025	0.022	0	0.095	0.025

6. POTENTIAL FOR HUMAN EXPOSURE

Table 6-4. U.S. Food and Drug Administration—Total Diet Study (TDS)—Market Baskets 91-3 through 99-1

Selenium—summary of results									
TDS food description	TDS food number	Number of results	Number of not detected	Number of traces	Mean (mg/kg)	Standard deviation (mg/kg)	Minimum (mg/kg)	Maximum (mg/kg)	Median (mg/kg)
Carrots, strained/ junior	218	26	25	1	0.001	0.005	0	0.026	0
Green beans, strained/ junior	219	26	24	2	0.001	0.005	0	0.019	0
Mixed vegetables, strained/ junior	220	26	17	7	0.009	0.018	0	0.081	0
Sweet potatoes, strained/ junior	221	26	26	0	0	0	0	0	0
Creamed corn, strained/ junior	222	26	11	9	0.017	0.021	0	0.074	0.012
Peas, strained/ junior	223	26	23	3	0.001	0.004	0	0.016	0
Creamed spinach, strained/ junior	224	25	6	13	0.022	0.017	0	0.068	0.026
Applesauce, strained/ junior	225	26	24	2	0.001	0.003	0	0.012	0
Peaches, strained/ junior	226	26	26	0	0	0	0	0	0
Pears, strained/ junior	227	25	24	1	0	0.002	0	0.012	0
Apple juice, strained	230	25	25	0	0	0	0	0	0
Orange juice, strained	231	26	26	0	0	0	0	0	0
Custard pudding, strained/ junior	232	26	5	10	0.032	0.019	0	0.071	0.035

6. POTENTIAL FOR HUMAN EXPOSURE

Table 6-4. U.S. Food and Drug Administration—Total Diet Study (TDS)—Market Baskets 91-3 through 99-1

Selenium—summary of results									
TDS food description	TDS food number	Number of results	Number of not detected	Number of traces	Mean (mg/kg)	Standard deviation (mg/kg)	Minimum (mg/kg)	Maximum (mg/kg)	Median (mg/kg)
Fruit dessert/ pudding, strained/ junior	233	26	25	1	0	0.002	0	0.011	0
Fruit-flavored yogurt, lowfat (fruit mixed in)	235	26	7	14	0.022	0.015	0	0.047	0.024
Swiss cheese	236	26	0	5	0.18	0.054	0.109	0.368	0.174
Cream cheese	237	26	4	8	0.053	0.031	0	0.099	0.054
Veal cutlet, pan-cooked	238	26	0	1	0.165	0.045	0.098	0.354	0.162
Ham luncheon meat, sliced	239	26	0	0	0.237	0.078	0.096	0.374	0.22
Chicken breast, roasted	240	25	0	1	0.27	0.12	0.09	0.623	0.228
Chicken nuggets, fast-food	241	25	0	1	0.2	0.1	0.052	0.595	0.177
Chicken, fried (breast, leg, and thigh), fast-food	242	25	0	1	0.218	0.065	0.131	0.353	0.21
Haddock, pan-cooked	243	19	0	0	0.397	0.076	0.256	0.503	0.4
Shrimp, boiled	244	25	0	0	0.38	0.1	0.2	0.574	0.369
Kidney beans, dry, boiled	245	26	8	12	0.02	0.017	0	0.051	0.019
Peas, mature, dry, boiled	246	26	10	4	0.05	0.09	0	0.457	0.034
Mixed nuts, no peanuts, dry roasted	247	25	1	0	0.53	0.39	0	1.8	0.44
Cracked wheat bread	248	26	0	0	0.285	0.065	0.209	0.448	0.269

6. POTENTIAL FOR HUMAN EXPOSURE

Table 6-4. U.S. Food and Drug Administration—Total Diet Study (TDS)—Market Baskets 91-3 through 99-1

Selenium—summary of results									
TDS food description	TDS food number	Number of results	Number of not detected	Number of traces	Mean (mg/kg)	Standard deviation (mg/kg)	Minimum (mg/kg)	Maximum (mg/kg)	Median (mg/kg)
Bagel, plain	249	26	0	0	0.311	0.085	0.165	0.518	0.299
English muffin, plain, toasted	250	26	0	0	0.263	0.068	0.144	0.402	0.25
Graham crackers	251	26	4	3	0.055	0.03	0	0.1	0.057
Butter-type crackers	252	26	4	2	0.061	0.031	0	0.102	0.069
Apricot, raw	253	21	19	2	0.001	0.004	0	0.015	0
Peach, canned in light/medium syrup	254	26	26	0	0	0	0	0	0
Pear, canned in light syrup	255	26	26	0	0	0	0	0	0
Pineapple juice, from frozen concentrate	256	26	26	0	0	0	0	0	0
Grape juice, from frozen concentrate	257	26	26	0	0	0	0	0	0
French fries, fast-food	258	26	22	4	0.003	0.007	0	0.023	0
Carrot, fresh, boiled	259	26	22	4	0.002	0.006	0	0.027	0
Tomato, stewed, canned	260	26	24	2	0.001	0.003	0	0.014	0
Tomato juice, bottled	261	26	20	6	0.004	0.007	0	0.023	0
Beets, fresh/frozen, boiled	262	25	22	3	0.002	0.006	0	0.023	0
Brussels sprouts, fresh/frozen, boiled	263	26	16	8	0.009	0.013	0	0.044	0
Mushrooms, raw	264	26	2	3	0.108	0.054	0	0.227	0.095
Eggplant, fresh, boiled	265	26	26	0	0	0	0	0	0

6. POTENTIAL FOR HUMAN EXPOSURE

Table 6-4. U.S. Food and Drug Administration—Total Diet Study (TDS)—Market Baskets 91-3 through 99-1

Selenium—summary of results									
TDS food description	TDS food number	Number of results	Number of not detected	Number of traces	Mean (mg/kg)	Standard deviation (mg/kg)	Minimum (mg/kg)	Maximum (mg/kg)	Median (mg/kg)
Turnip, fresh/frozen, boiled	266	26	23	3	0.002	0.006	0	0.025	0
Okra, fresh/frozen, boiled	267	26	22	3	0.003	0.008	0	0.03	0
Mixed vegetables, frozen, boiled	268	26	20	6	0.004	0.008	0	0.032	0
Beef stroganoff, homemade	269	26	0	0	0.191	0.043	0.121	0.311	0.183
Green peppers stuffed with beef and rice, homemade	270	26	3	4	0.065	0.029	0	0.113	0.066
Chili con carne with beans, homemade	271	26	3	6	0.052	0.025	0	0.09	0.057
Tuna noodle casserole, homemade	272	26	0	1	0.173	0.042	0.107	0.281	0.166
Salisbury steak with gravy, potatoes, and vegetable, frozen meal, heated	273	26	6	4	0.034	0.022	0	0.062	0.041
Turkey with gravy, dressing, potatoes, and vegetable, frozen meal, heated	274	26	0	5	0.093	0.025	0.051	0.17	0.091

6. POTENTIAL FOR HUMAN EXPOSURE

Table 6-4. U.S. Food and Drug Administration—Total Diet Study (TDS)—Market Baskets 91-3 through 99-1

Selenium—summary of results									
TDS food description	TDS food number	Number of results	Number of not detected	Number of traces	Mean (mg/kg)	Standard deviation (mg/kg)	Minimum (mg/kg)	Maximum (mg/kg)	Median (mg/kg)
Quarter-pound cheese-burger on bun, fast-food	275	26	0	0	0.18	0.041	0.108	0.331	0.18
Fish sandwich on bun, fast-food	276	26	0	0	0.184	0.04	0.109	0.281	0.189
Frankfurter on bun, fast-food	277	26	0	3	0.199	0.048	0.096	0.315	0.197
Egg, cheese, and ham on English muffin, fast-food	278	26	0	0	0.263	0.079	0.095	0.451	0.256
Taco/tostada, from Mexican carry-out	279	26	2	3	0.103	0.039	0	0.161	0.104
Cheese pizza, regular crust, from pizza carry-out	280	26	0	0	0.239	0.053	0.138	0.332	0.235
Cheese and pepperoni pizza, regular crust, from pizza carry-out	281	26	0	0	0.229	0.067	0.068	0.381	0.225
Beef chow mein, from Chinese carry-out	282	26	3	5	0.068	0.043	0	0.192	0.071
Bean with bacon/pork soup, canned, condensed, prepared with water	283	26	7	19	0.015	0.013	0	0.052	0.014

6. POTENTIAL FOR HUMAN EXPOSURE

Table 6-4. U.S. Food and Drug Administration—Total Diet Study (TDS)—Market Baskets 91-3 through 99-1

Selenium—summary of results									
TDS food description	TDS food number	Number of results	Number of not detected	Number of traces	Mean (mg/kg)	Standard deviation (mg/kg)	Minimum (mg/kg)	Maximum (mg/kg)	Median (mg/kg)
Mushroom soup, canned, condensed, prepared with whole milk	284	26	5	18	0.021	0.017	0	0.061	0.019
Clam chowder, New England, canned, condensed, prepared with whole milk	285	26	4	12	0.032	0.018	0	0.06	0.036
Vanilla ice cream	286	26	6	19	0.019	0.012	0	0.043	0.021
Fruit flavor sherbet	287	26	21	4	0.005	0.013	0	0.059	0
Popsicle, any flavor	288	26	25	1	0.001	0.006	0	0.03	0
Chocolate snack cake with chocolate icing	289	26	9	15	0.02	0.017	0	0.056	0.025
Cake doughnuts with icing, any flavor, from doughnut store	290	26	0	7	0.097	0.036	0.032	0.164	0.097
Brownies, commercial	291	26	4	7	0.045	0.026	0	0.096	0.049
Sugar cookies, commercial	292	26	4	13	0.039	0.025	0	0.091	0.035
Suckers, any flavor	293	26	24	1	0.003	0.014	0	0.07	0
Pretzels, hard, salted, any shape	294	26	5	7	0.04	0.025	0	0.094	0.043

6. POTENTIAL FOR HUMAN EXPOSURE

Table 6-4. U.S. Food and Drug Administration—Total Diet Study (TDS)—Market Baskets 91-3 through 99-1

Selenium—summary of results									
TDS food description	TDS food number	Number of results	Number of not detected	Number of traces	Mean (mg/kg)	Standard deviation (mg/kg)	Minimum (mg/kg)	Maximum (mg/kg)	Median (mg/kg)
Chocolate syrup dessert topping	295	26	20	5	0.006	0.013	0	0.054	0
Jelly, any flavor	296	26	25	1	0.001	0.005	0	0.025	0
Sweet cucumber pickles	297	26	22	4	0.002	0.005	0	0.017	0
Yellow mustard	298	26	0	0	0.33	0.13	0.103	0.724	0.308
Black olives	299	26	25	0	0.001	0.007	0	0.038	0
Sour cream	300	26	4	20	0.027	0.022	0	0.1	0.022
Brown gravy, homemade	301	26	7	9	0.031	0.025	0	0.094	0.032
French salad dressing, regular	302	26	14	10	0.017	0.036	0	0.184	0
Italian salad dressing, low-calorie	303	26	24	2	0.002	0.006	0	0.023	0
Olive/safflower oil	304	26	25	1	0.001	0.003	0	0.014	0
Coffee, from ground	305	26	26	0	0	0	0	0	0
Fruit-flavored carbonated beverage	306	26	25	1	0.001	0.004	0	0.022	0
Fruit drink, canned	307	26	24	2	0.001	0.005	0	0.022	0
Martini	308	26	26	0	0	0	0	0	0
Soy-based infant formula, ready-to-feed	309	26	8	17	0.013	0.009	0	0.023	0.016
Egg yolk, strained/junior	310	12	0	0	0.293	0.026	0.253	0.33	0.292

6. POTENTIAL FOR HUMAN EXPOSURE

Table 6-4. U.S. Food and Drug Administration—Total Diet Study (TDS)—Market Baskets 91-3 through 99-1

Selenium—summary of results									
TDS food description	TDS food number	Number of results	Number of not detected	Number of traces	Mean (mg/kg)	Standard deviation (mg/kg)	Minimum (mg/kg)	Maximum (mg/kg)	Median (mg/kg)
Rice infant cereal, instant, prepared with whole milk	311	26	5	3	0.051	0.03	0	0.093	0.06
Bananas with tapioca, strained/ junior	312	20	9	11	0.011	0.011	0	0.032	0.016
Beets, strained/ junior	313	26	25	1	0	0.002	0	0.01	0
Split peas with vegetables and ham/bacon, strained/ junior	314	15	15	0	0	0	0	0	0
Teething biscuits	316	26	8	18	0.015	0.011	0	0.038	0.017
Rice cereal with apple, strained/ junior	317	26	0	0	0.192	0.052	0.109	0.356	0.188
Squash, strained/ junior	318	6	0	0	0.285	0.052	0.205	0.341	0.29

6. POTENTIAL FOR HUMAN EXPOSURE

6.5 GENERAL POPULATION AND OCCUPATIONAL EXPOSURE

Because selenium is ubiquitous in the environment and has been detected in so many media, exposure of the general population to selenium can occur in a variety of ways, including occupational exposure, inhalation, and ingestion of selenium via drinking water, foods, and selenium supplements. For exposure via the food pathway, Schubert et al. (1987) estimated that beef, white bread, pork or ham, chicken, and eggs provide over 50% of the daily selenium intake in the U.S. population. FDA (1982a) estimated that the greatest portion of daily selenium intake occurs from the ingestion of grains and cereals (51.8%). Meat, fish, and poultry were estimated to contribute 36.4% and dairy products were estimated to contribute 9.7% (FDA 1982a).

Various estimates of the selenium intake for Americans have ranged from 0.071 to 0.152 mg/day (DHHS 2002; FDA 1982a; Levander 1987; Pennington et al. 1989; Schrauzer and White 1978; Schubert et al. 1987; Welsh et al. 1981). Schubert et al. (1987) estimated the intake of selenium for the U.S. population to be 0.071 mg/day. They based their estimate on their review of selenium concentrations in different types of foods and the amount of each type of food eaten. The amount of each food type eaten daily was estimated from the U.S. Department of Agriculture's 1977–1978 Nationwide Food Consumption Survey (NFCS). Welsh et al. (1981) estimated the mean daily selenium intake of a group of 22 Maryland residents to be 0.081 mg/day (the median was 0.074 mg/day). In California, the mean daily selenium intake of eight individuals was estimated to be 0.127 mg/day (Schrauzer and White 1978). FDA (1982a) estimated the average daily selenium intake of the U.S. population to be 0.1523 mg/day (152.3 µg/day). Pennington et al. (1989) estimated the daily dietary intake of selenium by age group and by sex between 1982 and 1986, based on FDA's Total Diet Studies for those years, to be between 0.020 mg/day (20 µg/day) for infants and 0.120 mg/day (120 µg/day) for adult males between 25 and 30 years of age. Based on information collected from 1988-94 in the third National Health and Nutrition Examination Survey (NHANES III), the dietary intake of selenium was estimated by sex and age in the United States (see Table 6-5). Based on data from this study, the average dietary intake for all ages and both sexes was estimated to be 0.114 mg/day (DHHS 2002). These values are sufficient to meet the RDA for selenium of 0.055 mg/day for men and women (NAS 2000).

Both inorganic selenium and selenomethionine are found in selenium supplements. The amounts in these supplements generally range from 10 to 25 µg/tablet (Goodman et al. 1990), although current products are

6. POTENTIAL FOR HUMAN EXPOSURE

Table 6-5. Selenium Dietary Intake ($\mu\text{g}/\text{day}$) by Sex and Age for the Total U.S. Population, 1988–1994 (DHHS 2002)^a

Sex and age	Sample size	Mean	SEM	Median
Both sexes				
All ages ^b	29,105	114	1.1	99
Under 6 years ^b	6,871	66	0.8	62
6–11 years	3,134	96	1.7	87
12–19 years	3,121	117	2.4	102
20–59 years	10,940	127	1.6	111
60 years and over	5,039	100	1.3	89
Male				
All ages ^b	13,923	134	1.6	118
Under 6 years ^b	3,410	69	1.0	64
6–11 years	1,581	102	2.8	92
12–19 years	1,462	140	3.1	125
20–59 years	5,019	153	2.1	137
60 years and over	2,451	118	1.7	106
Female				
All ages ^b	15,182	94	1.1	85
Under 6 years ^b	3,461	63	0.9	59
6–11 years	1,553	90	1.6	82
12–19 years	1,659	93	2.4	87
20–59 years	5,921	102	1.8	92
60 years and over	2,588	87	1.6	78

^aBased on information collected in the third National Health and Nutrition Examination Survey (NHANES III).

^bExcludes nursing infants and children, includes data for poverty income ratio.

SEM = Standard error of the mean

6. POTENTIAL FOR HUMAN EXPOSURE

available in the 100–200 µg/tablet level. A guide to vitamin and minerals recommends that not more than 200 µg selenium/day should be taken in any form (Hendler 1990).

The mean whole blood selenium concentration of residents from 19 U.S. cities ranged from 0.10 to 0.34 mg/L with a mean value of 0.21 mg/L (Barceloux 1999). A synopsis of selenium concentrations in human tissues has been summarized in Table 3-6. Based on information collected from 1988 to 94 in NHANES III, the serum concentration of selenium was estimated by sex and age in the United States (see Table 6-6). Based on data from this study, the mean selenium serum concentration for all ages and both sexes was estimated to be 0.125 mg/L (DHHS 1997).

The National Occupation Hazard Survey (NOHS), conducted by the National Institute for Occupational Safety and Health (NIOSH), estimated that 108,682 workers in 15,127 plants were potentially exposed to selenium in the workplace in 1970 (NOHS 1976). These estimates were derived from observations of the actual use of selenium (1% of total estimate), the use of trade name products known to contain selenium (4%), and the use of generic products suspected of containing the selenium compounds (95%). The largest numbers of exposed workers were heavy equipment mechanics, painters, mechanics in service stations, and special trade contractors. Data from a second workplace survey, the National Occupational Exposure Survey (NOES), conducted by NIOSH from 1981 to 1983, indicated that 27,208 workers, including 9,632 women, in 1,102 plants were potentially exposed to selenium in the workplace (NIOSH 1983). The majority of these workers were employed in the health services (e.g., nursing), as janitors and cleaners, as machine operators, in the metals industry, or in work involving food and kindred products. These estimates were derived from observations of the actual use of selenium (87% of the total estimate) and the use of trade name products known to contain the selenium compounds (13%) (NIOSH 1989). Neither the NOHS database nor the NOES database contain information on the frequency, level, or duration of the exposure of workers to any of the chemicals listed therein. They are surveys that provide estimates of workers potentially exposed to the chemicals.

The average selenium concentration in the blood of 20 workers employed in a rubber tire repair shop located in Mexico was 148 µg/L, while the average concentration in a control group of 18 healthy volunteers was 100 µg/L (Sánchez-Ocampo et al. 1996). Selenium was measured in the blood of 222 coal miners at concentrations ranging from 34.9–99.5 µg/L (Orszczyn et al. 1996). Selenium content in the blood decreased with age and unexpectedly, smokers had slightly lower blood plasma concentrations than nonsmokers. Furthermore, the most exposed miners (miners exposed to coal dust for more than 10 years)

6. POTENTIAL FOR HUMAN EXPOSURE

Table 6-6. Serum Selenium Concentrations ($\mu\text{g/L}$) in U.S. Population from NHANES III (DHHS 1997)^a

Sex and age	<i>n</i>	Population ^b	Mean	SEM	GM	GM SE
Both sexes						
All ages	18,292	192,615,658	124.75	0.47	123.63	0.44
<6 years old	0	0	—	—	—	—
6–11 years old	0	0	—	—	—	—
12–19 years old	2,968	25,412,279	121.09	0.49	120.03	0.46
20–59 years old	10,519	129,562,302	125.25	0.49	124.17	0.45
60 years and older	4,905	37,641,076	125.48	0.55	124.26	0.54
Males						
All ages	8,561	92,798,087	126.16	0.53	125.10	0.50
<6 years old	0	0	—	—	—	—
6–11 years old	0	0	—	—	—	—
12–19 years old	1,330	12,835,980	121.46	0.58	120.57	0.57
20–59 years old	4,839	63,886,151	127.22	0.56	126.17	0.52
60 years and older	2,392	16,075,956	125.72	0.61	124.54	0.59
Females						
All ages	9,731	99,817,571	123.43	0.45	122.29	0.43
<6 years old	0	0	—	—	—	—
6–11 years old	0	0	—	—	—	—
12–19 years old	1,538	12,576,300	120.71	0.68	119.47	0.63
20–59 years old	5,680	65,676,151	123.34	0.45	122.26	0.42
60 years and older	2,513	21,565,120	125.30	0.58	124.04	0.57

^aData source: Third National Health and Nutrition Examination Survey (NHANES III), 1988–1994 (DHHS 1997).
Data analysis: Syracuse Research Corporation, Syracuse, NY, using SUDAAN[®] and SAS[®].

^bPortion of the United States represented by the sample

GM = geometric mean; GM SE = standard error of the geometric mean; SEM = Standard error of the mean

6. POTENTIAL FOR HUMAN EXPOSURE

had lower selenium plasma levels than recently hired miners. Although the precise mechanism explaining the decrease in selenium concentration with dust exposure and smoking is unknown, the authors speculated that the decreased selenium levels might reflect its use by the increased demand in antioxidant protection, involving glutathione-peroxidase. Concentrations of selenium in the plasma and urine of copper refinery workers was studied (Rajotte et al. 1996). The levels of selenium in the urine and plasma of the 20 workers were 34.02–189.95 and 113.93–173.57 $\mu\text{g/L}$, respectively. The respective selenium levels in a control group that was not occupationally exposed were 26.71–118.39 $\mu\text{g/L}$ and 119.51–187.35 $\mu\text{g/L}$.

6.6 EXPOSURES OF CHILDREN

This section focuses on exposures from conception to maturity at 18 years in humans. Differences from adults in susceptibility to hazardous substances are discussed in 3.7 Children's Susceptibility.

Children are not small adults. A child's exposure may differ from an adult's exposure in many ways. Children drink more fluids, eat more food, breathe more air per kilogram of body weight, and have a larger skin surface in proportion to their body volume. A child's diet often differs from that of adults. The developing human's source of nutrition changes with age: from placental nourishment to breast milk or formula to the diet of older children who eat more of certain types of foods than adults. A child's behavior and lifestyle also influence exposure. Children crawl on the floor, put things in their mouths, sometimes eat inappropriate things (such as dirt or paint chips), and spend more time outdoors. Children also are closer to the ground, and they do not use the judgment of adults to avoid hazards (NRC 1993).

Children are exposed to selenium by the same pathways as adults. The primary route of exposure for children is through the ingestion of food sources. Selenium has been identified in pasteurized milk and milk-based infant formulas in the United States at mean concentrations in the range of 0.011–0.070 mg/kg (Table 6-4). Children may also be exposed to selenium by breast feeding mothers. Selenium was identified in the postpartum breast milk of women at different lactation stages at concentrations of 6.1–53.4 $\mu\text{g/L}$ (Li et al. 1999). Using these concentrations, the daily intake of selenium for fully breast fed infants was estimated to range from 5.2 to 17.9 $\mu\text{g/day}$. Others have reported the estimated daily dietary intake of selenium for infants as 20 $\mu\text{g/day}$, while the daily intake for adult males was estimated as 120 $\mu\text{g/day}$ (Pennington 1989). Selenium was detected in the umbilical blood of 350 subjects in the Czech Republic at concentrations of 4.0–82.6 $\mu\text{g/L}$ (Černá et al. 1997). The concentration of selenium in

6. POTENTIAL FOR HUMAN EXPOSURE

the blood of 388 children (196 males, 192 females) ranged from 5.0 to 98.2 $\mu\text{g/L}$ (Černá et al. 1997). Selenium was detected in fetal tissues at a mean concentration of 2.8 $\mu\text{g/g}$ (Robkin et al. 1973). The concentration of selenium in various tissues of infants has been reported by Dickson and Tomlinson (1967) and is summarized in Table 3-6. In areas containing low (0.42 mg/kg), medium (3.09 mg/kg), and high (9.54 mg/kg) seleniferous soils, the mean whole blood selenium levels of school children (7–14 years of age) were 0.13, 0.37, and 1.57 mg/L, respectively (Yang et al. 1989b). Selenium was detected in postmortem liver, lung, and spleen samples of infants in Glasgow, Scotland at mean concentrations of 2.24, 0.76, and 0.099 ppm, respectively (Raie 1996).

The tendency of young children to ingest soil, either intentionally through pica or unintentionally through hand-to-mouth activity, is well documented. This potential route of exposure is most likely in areas that naturally have high selenium content in soil. Since children often play in fields and soils, both dermal exposure and inhalation of dust particles from soil surfaces are possible. The soluble forms of selenium such as the inorganic alkali selenites and selenates are more likely to be bioavailable in soils than the relatively insoluble selenides. Children are not likely to be exposed to selenium from their parents' work clothes, skin, hair, tools, or other objects removed from the workplace. Selenium is contained in some household products such as shampoos and preparations to treat dandruff and eczema (IARC 1975a). It is also contained in some dietary supplements (Goodman et al. 1990). Since it is unlikely that children would use these products without adult supervision, the potential for overexposure to selenium from these products is low, except for the possibility of accidental poisoning.

6.7 POPULATIONS WITH POTENTIALLY HIGH EXPOSURES

Because selenium is a naturally occurring element found in rocks, soils, plants, and animals, the general population is commonly exposed to selenium through diet and drinking water. As a result of the uneven distribution of selenium in the earth's crust, populations living in certain areas of the United States are exposed to greater than average levels of selenium. Areas of the United States with highly seleniferous soils and plants include South Dakota, Wyoming, Montana, North Dakota, Nebraska, Kansas, Colorado, Utah, Arizona, and New Mexico (Valentine et al. 1978). Hawaii also has high levels of selenium in the soil, but not in plants (Smith et al. 1936; Valentine et al. 1978). Human exposure to selenium occurs through the ingestion of food (including meat, milk, eggs, and vegetables) and drinking water from these areas (Smith et al. 1936). Selenium was found at elevated levels in fish from rivers, creeks, and lakes in California, North Carolina, Texas, and Utah (RTI 1993). Farmers and fishermen living in these regions

6. POTENTIAL FOR HUMAN EXPOSURE

may be at higher risk of selenium exposure than people living in urban areas because farmers tend to consume a larger proportion of locally grown foods, and fishermen tend to consume seafood, whereas people in urban areas tend to consume foods grown over a wider geographic area. In addition, people who irrigate their home gardens with groundwater containing high selenium levels may grow and consume plants that contain high levels of selenium because this element accumulates in some plants. Fishermen and hunters of waterfowl who regularly consume fish and game from waterways with elevated selenium levels may increase their selenium body burden, but no reports of selenosis attributable to this practice have appeared in the literature.

People living in the vicinity of hazardous waste sites or coal burning plants may also be exposed to high levels of selenium. Selenosis has been reported in residents of the Wudang Mountains, China where food was grown in highly seleniferous soil (Yang et al. 1989a, 1989b). Selenium blood levels of five patients with long persisting, distinct clinical signs of selenosis ranged from 1.054 to 1.854 mg/L (Yang et al. 1989b). To attain selenium blood levels of this magnitude, it was estimated that the daily intake must be at least 910 µg/day. The mean selenium concentration in hair samples obtained from residents of a highly seleniferous region of Glasgow, Scotland was 18.92 ppm (Raie 1996). By comparison, the mean levels for adults from Iran and Iceland were only 5.72 and 1.81 ppm, respectively.

6.8 ADEQUACY OF THE DATABASE

Section 104(i)(5) of CERCLA, as amended, directs the Administrator of ATSDR (in consultation with the Administrator of EPA and agencies and programs of the Public Health Service) to assess whether adequate information on the health effects of selenium is available. Where adequate information is not available, ATSDR, in conjunction with the National Toxicology Program (NTP), is required to assure the initiation of a program of research designed to determine the health effects (and techniques for developing methods to determine such health effects) of selenium.

The following categories of possible data needs have been identified by a joint team of scientists from ATSDR, NTP, and EPA. They are defined as substance-specific informational needs that if met would reduce the uncertainties of human health assessment. This definition should not be interpreted to mean that all data needs discussed in this section must be filled. In the future, the identified data needs will be evaluated and prioritized, and a substance-specific research agenda will be proposed.

6. POTENTIAL FOR HUMAN EXPOSURE

6.8.1 Identification of Data Needs

Physical and Chemical Properties. The physical and chemical properties of elemental selenium and most of the common environmental forms of selenium have been characterized (Budavari et al. 1996; Lide 2000) and no further data are needed (see Chapter 4).

Production, Import/Export, Use, Release, and Disposal. Knowledge of a chemical's production volume is important because it often correlates with possible environmental contamination and human exposure. Current data regarding the import (USGS 2002), export (USGS 2002), and use (Hoffmann and King 1997) of selenium are available. No statistics regarding the U.S. production of selenium have been reported since 1996 (USGS 2002). Current information on the U.S. production of selenium would assist in identifying potential exposures, particularly in regions of the country where environmental exposure to selenium through food and drinking water is already relatively high.

According to the Emergency Planning and Community Right-to-Know Act of 1986, 42 U.S.C. Section 11023, industries are required to submit substance release and off-site transfer information to EPA. The Toxics Release Inventory (TRI), which contains this information for 2000, became available in May of 2002. This database will be updated yearly and should provide a list of industrial production facilities and emissions.

Environmental Fate. Information is available to permit assessment of the environmental fate and transport of selenium in air (NAS 1976a), water (Chau and Riley 1965; NAS 1980b; Ohlendorf et al. 1986a; Rudd and Turner 1983a; Saiki and Lowe 1987), and soil (Kabatas-Pendias and Pendias 1984, NAS 1976b). Selenium released to the air will be removed by wet and dry deposition. The forms of selenium expected to be found in surface water and the water contained in soils are the salts of selenic and selenious acids. Selenic acid (H_2SeO_4) is a strong acid. The soluble selenate salts of this acid are expected to occur in alkaline waters. Sodium selenate is one of the most mobile selenium compounds in the environment because of its high solubility and inability to adsorb onto soil particles (NAS 1976a). Selenious acid (H_2SeO_3) is a weak acid, and the diselenite ion predominates in waters between pH 3.5 and 9. Most selenites are less soluble in water than the corresponding selenates (NAS 1980b).

It has been suggested that a biological cycle exists for selenium (Shrift 1964), but certain components of the cycle remain uncharacterized. The biological transformation of selenide to elemental selenium has not been well described in the literature (see Maier et al. 1988). Further research on the biological

6. POTENTIAL FOR HUMAN EXPOSURE

selenium cycle might help to identify "hot spots" of selenium in the environment. For example, further investigation of parameters that influence the tendency of selenium to move from one medium to another (e.g., from soil to water) would improve fate and transport modeling efforts.

Bioavailability from Environmental Media. The available monitoring data indicate that selenium is present in samples of air (Dams et al. 1970; Harrison et al. 1971; John et al. 1973; Peirson et al. 1973; Pillay et al. 1971), water (Besser et al. 1996; CRWQCB 1988; Cutter 1989; Glover et al. 1979; Lakin and Davidson 1967; Lewis 1988; Maier et al. 1988; NCDNR 1986; Oster et al. 1988a; Schutz and Turekiam 1965; Smith and Westfall 1937), soil/sediment (Glover et al. 1979; Lemly 1997; Sindeeva 1964), human tissues (Li et al. 1999; Orszczyn et al. 1996; Yang et al. 1989a, 1989b), fish (Besser et al. 1996; Lowe et al. 1985; May and McKinney 1981; Ohlendorf et al. 1986b), and food (Beale et al. 1990; FDA 2000; Schubert et al. 1987). Thus, it can be concluded that selenium is bioavailable from the environmental media.

Food Chain Bioaccumulation. Selenium in food contributed to the highest proportion of the daily selenium intake for human populations in the United States. Fruits, vegetables, milk, meat, and grains contain very low levels of selenium. However, selenium is bioaccumulated by aquatic organisms (Chau and Riley 1965; Ohlendorf et al. 1986a; Rudd and Turner 1983a). Based on reported BCFs and BAFs (Lemly 1982, 1985), selenium is expected to bioaccumulate in fish. Some evidence indicates that under natural conditions, selenium might also biomagnify in aquatic organisms (Lemly 1985; Maier et al. 1988; NCDNR 1986; Sandholm et al. 1973).

Exposure Levels in Environmental Media. Selenium has been detected in air (Dams et al. 1970; Harrison et al. 1971; John et al. 1973; Peirson et al. 1973; Pillay et al. 1971), water (CRWQCB 1988; Cutter 1989; Glover et al. 1979; Lakin and Davidson 1967; Lewis 1988; Maier et al. 1988; NCDNR 1986; Oster et al. 1988a; Schutz and Turekiam 1965; Smith and Westfall 1937), soil and sediment (Beath et al. 1946; Coleman and Delevaux 1957; Glooschenko and Arafat 1988; Glover et al. 1979; Lemly 1997; NAS 1976a; Rosenfeld and Beath 1964; Shamberger 1981; Sindeeva 1964), coal and oil (Hashimoto et al. 1970; Pillay et al. 1969), plants (Arthur et al. 1992; Cappon 1981; Horne 1991; Rosenfeld and Beath 1964; Shane et al. 1988), and food (Beale et al. 1990; FDA 2000; Schubert et al. 1987). Continued monitoring data of selenium levels in the environment are necessary to understand current exposure levels.

6. POTENTIAL FOR HUMAN EXPOSURE

Reliable monitoring data for the levels of selenium and selenium compounds in contaminated media at hazardous waste sites are needed. This information can be used in combination with the known body burden of selenium and selenium compounds to assess the potential risk of adverse health effects in populations living in the vicinity of hazardous waste sites.

Exposure Levels in Humans. Selenium has been detected in the blood (Barceloux 1999; Orszczyn et al. 1996), urine (Gromadzinska et al. 1996), hair (Raie 1996; Yang et al. 1989a, 1989b), and nails (Yang et al. 1989a, 1989b) of exposed individuals. Various estimates of selenium intake for the U.S. populations have been reported (FDA 1982a; Levander 1987; Pennington et al. 1989; Schrauzer and White 1978; Schubert et al. 1987; Welsh et al. 1981). The largest numbers of exposed workers were heavy equipment mechanics, painters, mechanics, and special trade contractors (NOHS 1976). Preliminary data from another workplace study indicate that workplace exposure decreased from 1976 to 1984 (NIOSH 1989). Continued monitoring data are necessary to understand and evaluate human exposures to selenium in both occupational and nonoccupational settings.

Exposures of Children. Data are available regarding the exposure and body burdens of children to selenium. Children, like adults, are primarily exposed to selenium through the diet. In areas containing low (0.42 mg/kg), medium (3.09 mg/kg), and high (9.54 mg/kg) seleniferous soils, the mean whole blood selenium levels of school children (7–14 years of age) were 0.13, 0.37, and 1.57 mg/L, respectively (Yang et al. 1989b). Selenium was detected in postmortem liver, lung, and spleen samples of infants in Glasgow, Scotland at mean concentrations of 2.24, 0.76, and 0.099 ppm, respectively (Raie 1996). Children can be exposed to selenium from breast feeding mothers. Selenium was identified in the postpartum breast milk of women at different lactation stages at concentrations of 6.1–53.4 µg/L (Li et al. 1999). Using these concentrations, the daily intake of selenium for fully breast fed infants was estimated to range from 5.2 to 17.9 µg/day. Others have reported the estimated daily dietary intake of selenium for infants as 20 µg/day, while the daily intake for adult males was estimated as 120 µg/day (Pennington 1989). Since selenium is found in soil surfaces and children ingest soil either intentionally through pica or unintentionally through hand-to-mouth activity, pica is a unique exposure pathway for children. While selenium is found in some home products like shampoos (IARC 1975a) and dietary supplements (Goodman et al. 1990), this exposure route should be low and will not disproportionately affect children. Continued monitoring data are necessary to understand potentially dangerous routes of childhood exposure.

6. POTENTIAL FOR HUMAN EXPOSURE

Child health data needs relating to susceptibility are discussed in 3.12.2 Identification of Data Needs: Children's Susceptibility.

Exposure Registries. No exposure registries for selenium or selenium compounds were located. This substance is not currently one of the compounds for which a subregistry has been established in the National Exposure Registry. The substance will be considered in the future when chemical selection is made for subregistries to be established. The information that is amassed in the National Exposure Registry facilitates the epidemiological research needed to assess adverse health outcomes that may be related to exposure to this substance.

The development of a registry of exposures would provide a useful reference tool in assessing exposure levels and frequencies. In addition, a registry developed on the basis of exposure sources would allow an assessment of the variations in exposure levels from one source to another and of the effect of geographical, seasonal, or regulatory actions on the level of exposure from a certain source. These assessments, in turn, would provide a better understanding of the needs for research or data acquisition based on the current exposure levels.

6.8.2 Ongoing Studies

A summary of some pertinent ongoing research related to selenium is reported. Federally sponsored research reported in the Federal Research in Progress (FEDRIP 2002) databases is shown in Table 6-7.

6. POTENTIAL FOR HUMAN EXPOSURE

Table 6-7. Ongoing Studies on the Environmental Effects of Selenium^a

Investigator	Affiliation	Study	Sponsor
Finley JW	University of North Dakota (Grand Forks, North Dakota)	Chemical forms of selenium in foods	USDA
Suarez DL, Amrhein C	University of California (Riverside, California)	Selenium and arsenic speciation and mobilization in irrigated soils and drainage waters	USDA
Baligar VC et al.	Virginia Polytechnical Institute and State University, (Blacksburg, Virginia)	Trace elements, chemistry, and plant uptake from soil applied coal by-products/organic amendments	USDA
Reddy KJ	University of Wyoming, (Laramie, Wyoming)	Biogeochemistry and management of salts and potentially toxic trace elements in arid-zone soils, sediments and waters	USDA
Kpombrekou- Ademawou K, Ankumah RO	Tuskegee University, (Tuskegee, Alabama)	Trace elements in broiler littered soils: fate and effects on nitrogen transformation	NRI Competitive Grant
Doner HE	University of California, (Berkeley, California)	Factors controlling the distribution of trace elements in the solid-phase of terrestrial ecosystems	USDA
Terry N	University of California, (Berkeley, California)	Use of constructed wetlands in the bioremediation of selenium contaminated waters	USDA
Basta N	Oklahoma State University (Stillwater, OK)	Chemistry and bioavailability of waste constituents in soils	USDA
Amrhein C	University of California (Riverside, California)	Biogeochemistry and management of salts and possible toxic trace elements in arid soils, sediments and waters	USDA
Doner H, Amundson R	University of California, (Berkeley, California)	Biogeochemistry and management of salts and potentially toxic trace elements in arid-zone soils, sediments and waters	USDA
Dudley LM et al.	Utah State University (Logan, Utah)	Biogeochemistry and Management of salts and potentially toxic elements in arid-zone soils sediments and water	USDA
Logan TJ, Traina, SJ	Ohio State University (Columbus, Ohio)	Chemistry and bioavailability of waste constituents in soils	USDA

^aSource: FEDRIP 2002

NRI = National Research Institute; USDA = United States Department of Agriculture

7. ANALYTICAL METHODS

The purpose of this chapter is to describe the analytical methods that are available for detecting, measuring, and/or monitoring selenium, its metabolites, and other biomarkers of exposure and effect to selenium. The intent is not to provide an exhaustive list of analytical methods. Rather, the intention is to identify well-established methods that are used as the standard methods of analysis. Many of the analytical methods used for environmental samples are the methods approved by federal agencies and organizations such as EPA and the National Institute for Occupational Safety and Health (NIOSH). Other methods presented in this chapter are those that are approved by groups such as the Association of Official Analytical Chemists (AOAC) and the American Public Health Association (APHA). Additionally, analytical methods are included that modify previously used methods to obtain lower detection limits and/or to improve accuracy and precision.

The analytical methods used to quantify selenium in biological and environmental samples are summarized below. Table 7-1 lists the applicable analytical methods used for determining selenium and selenium compounds in biological fluids and tissues, and Table 7-2 lists the methods used for determining selenium in environmental samples.

7.1 BIOLOGICAL MATERIALS

Sampling of biological material for determination of total selenium concentrations does not usually pose a problem unless specific selenium compounds are to be identified (Bem 1981). One exception is the collection and storage of urine samples without loss of volatile selenium compounds (Bem 1981). Unless special precautions are taken, most analyses of biological materials probably underestimate the concentration of these compounds. Ideally, selenium should be measured in 24-hour urine samples that have been stored in polyethylene containers in acid medium (Sanz Alaejos and Diaz Romero 1993). Blood samples should be separated into plasma or serum and cell fractions prior to freezing if the selenium levels in these components are to be measured separately. Freezing of biological samples immediately following collection is recommended to reduce enzymatic formation of volatile selenium compounds.

7. ANALYTICAL METHODS

Table 7-1. Analytical Methods for Determining Selenium in Biological Materials

Sample matrix	Preparation method	Analytical method	Sample detection limit	Percent recovery	Reference
Air (breath)	Calibrate personal sampling pump; sample at a known flow rate for a total sample size of 5–2,000 L; analyze at 190.6 nm	ICP/AES	21 ng/mL	97–105%	NIOSH 1994a (method 7300)
Blood	Mineralize using HNO ₃ -HClO ₄ mixture, generate hydride, and atomize	HGAAS	1x10 ⁻⁸ g/g	No data	Clinton 1977
	Digest blood sample with a nitric/perchloric acid mixture; fume mixture at 200 °C and measure 2,3-diaminonaphthalene	Fluorometric	1.2x10 ⁻⁹ g/g	98%	Rongpu et al. 1986
Blood, plasma, or tissue homogenate	Digest with Mg(NO ₃) ₂ or HNO ₃ at a solution temperature of 100 °C for 60–90 minutes; add HCl; and add hydroxylamine sulfate, EDTA, and urea	GC/ECD	1x10 ⁻⁸ g/g	95–105%	McCarthy et al. 1981
Serum	Dilute sample with matrix modifier containing Mg(NO ₃) ₂ and Ni(NO ₃) ₂ to thermally stabilize Se; heat, dry, atomize; use Zeeman background correction	ZAAS	No data	6.2% relative standard deviation	Lewis et al. 1986b
	Dilute sample with matrix modifier containing NiCl ₂ ; heat, dry, and atomize	GFAAS	No data	84–116%	Oster and Prellwitz 1982
	Nitric-perchloric acid digestion; HCl reduction; sodium borohydride reduction; measure selenium hydride	HGAAS	No data	33–73%	Oster and Prellwitz 1982
	On-line acid ashing of sample followed by hydride generation	ICP/AES	5.5 µg/L	98–106%	Recknagel et al. 1993

7. ANALYTICAL METHODS

Table 7-1. Analytical Methods for Determining Selenium in Biological Materials

Sample matrix	Preparation method	Analytical method	Sample detection limit	Percent recovery	Reference
Urine	24-hour samples analyzed to measure CT and selenium concentration in urine	Folin-Wu method for CT measurement; fluorimetric method to measure Se	No data	No data	Hojo 1981b, 1982
	Digest sample with HNO ₃ and HClO ₄	Fluorometric	No data	100±22%	Koh and Benson 1983
	Add nitric acid, platinum, and nickel	EAAS	No data	4–8% relative deviation	Saeed 1986
Human spermatozoa and protasomes	Digest with 25% tetramethylammonium hydroxide in methanol	GFAAS	1x10 ⁻⁸ g/g	95.1±5.2%	Suistomaa et al. 1987
Biological samples	Decompose sample with nitric acid; use 1,2-dibromobenzene as a reagent to measure piaszelenol	GC/ECD	1x10 ⁻⁹ g/g	No data	Shimoishi 1977
	Spike sample with ⁸² Se; digest; acidify with HCl; react with 4-nitro-o-phenylene-diamine; measure nitro-piazselenol	IDGC/MS	5x10 ⁻¹¹ g/g	No data	Lewis 1988
Liver	Lyophilize sample; irradiate the sample; digest with HNO ₃ , HClO ₄ , and the carrier source; distill sample, and use distillate for analysis	Radiochemical NAA	2.2x10 ⁻¹⁰ g/g	No data	Lievens et al. 1977
Protein (human liver)		INAA and gel filtration	No data	No data	Norheim and Steinnes 1975

CT = creatinine; EAAS = electrothermal atomic absorption spectroscopy; EDTA = ethylenediaminetetraacetic acid; GC/ECD = gas chromatography/electron capture detection; GFAAS = graphite furnace atomic absorption spectroscopy; HCl = hydrochloric acid; HClO₄ = perchloric acid; HGAAS = hydride generation atomic absorption spectroscopy; HNO₃ = nitric acid; ICP/AES = inductively coupled plasma/atomic emission spectroscopy; IDGC/MS = isotope dilution gas chromatography/mass spectrometry; INAA = instrumental neutron activation analysis; Mg(NO₃)₂ = magnesium nitrate; NAA = neutron activation analysis; NiCl₂ = nickel chloride; Se = selenium; ZAAS = graphite furnace atomic absorption spectroscopy with Zeeman background correction

7. ANALYTICAL METHODS

Table 7-2. Analytical Methods for Determining Selenium in Environmental Samples

Sample matrix	Preparation method	Analytical method	Sample detection limit	Percent recovery	Reference
Food	Reduce selenium in sample from SeVI to SeIV; add zinc to the acidified sample; pass gaseous selenium hydride to AA	AA, gaseous hydride	2×10^{-9} g/mL	100%	EPA 1979a (method 270.3)
	Microwave digestion; acidify with HNO ₃	ICP-MS	No data	156% (fine flour); 149% (milk powder)	Zhou and Liu (1997)
Water	Acidify sample with HCl, degas solution with N ₂ bubbling	HGGC with photo-ionization detection	1×10^{-12} g/mL (0.001 ppb)	No data	Vien and Fry 1988
	Reduce selenium to SeIV with HCl and KBr; coprecipitate with lanthanum hydroxide; centrifuge.	ICP/AES	0.06 µg/L	100% selenite; 88% selenate	Adkins et al. 1995
	Acid digestion	ICP/AES	21 ng/mL	97-105%	NIOSH (2001)
Water and waste water	Acid digestion	AA, furnace	2×10^{-9} g/mL	94–112%	EPA 1979a (method 270.2)
Water and wastes	Acid digestion	AA, furnace	5×10^{-9} g/mL	No data	EPA 1984b (method 200.7 CLP-M)
Solid/solid waste/sludge	Aqueous samples subject to acid digestion	AA, furnace	2×10^{-9} g/mL	No data	EPA 1984c (method 7740)
	Acid digestion; measure at 196 nm	ICP and GFAAS	7.5×10^{-8} g/mL	94–112%	EPA 1986c (methods 3050, 6010)
	Acid digestion with HNO ₃ /sulfuric acid; convert SeIV to volatile hydride	AA, gaseous hydride	2×10^{-9} g/mL	100%	EPA 1997a (method 7741a)
	Acid digestion	AA, furnace	2×10^{-9} g/mL	No data	EPA 1984b (method 270.2 CLP-M)

7. ANALYTICAL METHODS

Table 7-2. Analytical Methods for Determining Selenium in Environmental Samples

Sample matrix	Preparation method	Analytical method	Sample detection limit	Percent recovery	Reference
Wastes/soil/ groundwater	Nitric acid digestion or nitric/peroxide/hydrochloric acid digestion	AA, furnace	3×10^{-9} g/mL	100.5 %	EPA 1997b (method 7742)
Organic waste	Oxidize organic samples, absorb combustion products in NaOH; separate on an ion exchange column	Cathodic stripping	5×10^{-9} g/mL	No data	DOE 1987
Marine biological tissues	Digest aqueous sample with HNO ₃ and perchloric acid Decompose tissue sample with HNO ₃ under pressure; add sulfuric and perchloric acids; heat at 310 °C to evaporate excess acid; add HCl	HGAAS	2×10^{-7} g/g	No data	Welz and Melcher 1985
Marine samples	Digest sample with concentrated HNO ₃ at room temperature; add HNO ₃ , perchloric, and sulfuric acids to complete digestion; evaporate extra acids; dissolve residue in HCl	HGAES-ICP	5×10^{-9} g/mL	No data	DOE 1987
Avian eggs and liver	Digest sample with HNO ₃ ; and hydrogen peroxide to increase solubility	GFAAS	4×10^{-7} g/g	No data	Krynitsky 1987
Fat materials (butter)	Melt butter under an infrared lamp; digest with HNO ₃ , sulfuric, and perchloric acids	HGAAS	10 ppb	No data	Narasaski 1985

7. ANALYTICAL METHODS

Table 7-2. Analytical Methods for Determining Selenium in Environmental Samples

Sample matrix	Preparation method	Analytical method	Sample detection limit	Percent recovery	Reference
Plants		Gravimetric method	2×10^{-6} g/g	No data	AOAC 1984 (method 3.101)
	Grind air-dried or fresh samples; acid digest with HNO ₃ and HCl; add EDTA; neutralize with NH ₄ OH; add HCl; shake with decalin; centrifuge decalin layer; read decalin solution with fluorometer at 525 nm within 5 minutes	Fluorometric method	$<4 \times 10^{-6}$ g/g	No data	AOAC 1984 (method 3.102 to 3.107)
Food	Digest sample with HNO ₃ , perchloric, and sulfuric acids; heat; add H ₂ O ₂ ; mix with EDTA, NH ₄ OH, and DAN; boil; add cyclohexane and shake; read cyclohexane layer at 525 nm	Titrimetric method	No data	No data	AOAC 1984 (methods 25.154 and 25.158)
Air (particulate)	Filter particulate matter from air; irradiate and count sample	NAA, non-destructive	1×10^{-10} g/m ³	No data	Dams et al. 1984
Air	Calibrate sampling pump; sample at a known flow rate for a total sample size of 13–2,000 L; analyze at 190.6 nm	ICP/AES	21 ng/mL	97–105%	NIOSH 1994a (method 7300)

AA = atomic absorption; AES = atomic emission spectrometry; CFAAS = graphite furnace atomic absorption spectroscopy; DAN = 2,3-diaminonaphthalene; EDTA = ethylenediamine tetraacetate; HCl = hydrochloric acid; HGAAS = hydride generation atomic absorption spectroscopy; HGAES = hydride generation atomic emission spectroscopy; HGGC = hydride generation gas chromatography; HNO₃ = nitric acid; ICP = inductively coupled plasma; KBr = potassium bromide; N₂ = nitrogen; NAA = neutron activation analysis; NaOH = sodium hydroxide; NH₄OH = ammonium hydroxide

7. ANALYTICAL METHODS

A variety of analytical methods can be used to determine trace concentrations (ng/g) of selenium in biological tissues. These include fluorometry, neutron activation analysis (NAA), atomic absorption spectroscopy (AAS), inductively coupled plasma-atomic emission spectroscopy (ICP-AES), inductively coupled plasma-mass spectrometry (ICP-MS), gas chromatography (GC), spectrophotometry, x-ray fluorescence analysis, and others.

Classical flame AAS techniques do not have sufficiently low detection limits for selenium to be useful for determining its presence in biological samples (Koirtyohann and Morris 1986). Hydride generation atomic absorption spectroscopy (HGAAS) has been used instead for determination of selenium in biological samples such as blood and blood constituents and meat, fruits, and vegetables (Bem 1981).

Graphite furnace atomic absorption spectroscopy (GFAAS) offers high sensitivity (5×10^{-11} g selenium/g sample), but interference from the matrix can cause significant difficulties (Lewis 1988). GFAAS methods rely on the fact that numerous metal compounds react with selenium compounds to form relatively refractory metal selenides (Oster and Prellwitz 1982). Nickel, molybdenum, and platinum are commonly added to the sample to thermally stabilize the selenium. Organic materials are then destroyed by high temperature in the furnace prior to atomization of the sample at very high temperatures (e.g., 2,700 °C) (Oster and Prellwitz 1982). One advantage of GFAAS techniques is that the material in the graphite sample cell can be chemically treated *in situ* to reduce chemical interference. GFAAS techniques require correction for background absorption. Correction techniques include the deuterium continuum light source method (Hoenig and Van Hoeyweghen 1986) and the Zeeman splitting of the absorption line (Koirtyohann and Morris 1986). A Zeeman-effect system, which applies a magnetic field to the atomizer, allows the background correction to be performed at the exact analyte wavelength without the use of auxiliary light sources (Fernandez and Giddings 1982). The Zeeman-effect background correction is necessary for the determination of selenium in blood and blood products when GFAAS is used because a spectral interference from iron occurs at the selenium wavelength that cannot be corrected by a deuterium continuum source.

A modification of the GFAAS method for determining selenium levels in human urine was described by Saeed (1986). In this electrothermal atomic absorption spectrometry (EAAS) method, nitric acid, nickel, and platinum are added to the graphite cell. The addition of nickel helps to mask the spectral interference from phosphates in urine. EAAS has been used to determine selenium levels in human spermatozoa (Suistomaa et al. 1987). For human blood plasma and serum, the detection limit of the EAAS method

7. ANALYTICAL METHODS

was 0.8 µg/L (2 ng absolute), with recoveries of 87–96% for plasma and 94–104% for serum (Harrison et al. 1996).

HGAAS offers reduced chemical interference but requires larger sample volumes than GFAAS techniques (Koirtyohann and Morris 1986). HGAAS techniques have been used to measure selenium concentrations in food (Fiorino et al. 1976). These techniques use wet-sample digestion (e.g., nitric-perchloric acid) to destroy organic matter. Sample reduction to convert Se(VI) (+6 valence state) to Se(IV) (+4 valence state) is necessary prior to using sodium borohydride to reduce all selenium present to selenium hydride (Macpherson et al. 1988). The selenium hydride is thermally decomposed and atomized in the sample beam of the atomic absorption spectrophotometer. Nitric-perchloric acid is commonly used for the digestion step. Because perchloric acid is potentially explosive, use of phosphoric acid instead is also common. Following the International Union of Pure and Applied Chemists (IUPAC) interlaboratory trial for the determination of selenium in human body fluids, Welz and Verlinden (1986) reported that it was important to use a temperature of at least 200 °C for sample decomposition when using HGAAS. They attributed the severe imprecision and systematic errors in measuring selenium in multiple samples to improper sample decomposition. Norheim and Haugen (1986) demonstrated that a combined system of a wet digestion and an automated hydride generator could analyze approximately 80 samples per day.

ICP-AES with hydride vapor generation has been used to determine total selenium in biological samples (Tracy and Moller 1990). This technique is especially suited to the analysis of small samples. Samples are wet ashed with nitric, sulfuric, and perchloric acids at temperatures up to 310 °C. After treatment with hydrochloric acid, selenium is reduced by sodium borohydride to hydrogen selenide in a simplified continuous flow manifold. A standard pneumatic nebulizer affects the gas-liquid separation of H₂Se, which is quantified by ICP-AES at 196.090 nm. The instrument detection limit for this method has been determined to be 0.4 µg/L

Hydride generation atomic fluorescence spectrometry (HGAFS) has been used to measure selenium concentrations in urine (Sabé et al. 2001). Samples were completely mineralized using a focused microwave oven with a mixture of nitric acid and sulfuric acid for 14 minutes. Complete recovery was achieved from selenocystine (SeCys), selenomethionine (SeMet), and trimethyl selenium (TMeSe) species. The detection and limit of quantization for this method were 57 and 190 pg selenium/L.

Application of gas-liquid chromatography (GLC) to determine selenium in biological samples allows for the elimination of interference from the biological matrix. GLC requires prior decomposition of organic

7. ANALYTICAL METHODS

matter with nitric acid. GLC techniques are based on measurement of the amount of piaszelenol formed by the reaction of selenium (*IV*) with appropriate reagents in acidic media (Bem 1981). For gas chromatographic determination of selenium with an electron capture detector, 1,2-diaminoarenes can be used as reagents to produce piaszelenols (McCarthy et al. 1981; Poole et al. 1977; Shimoishi 1977; Young and Christian 1973). Using 1,2-diamino-3,5-dibromobenzene as a reagent, Shimoishi (1977) obtained a detection limit of 1×10^{-9} g selenium per gram of sample.

Isotope dilution gas chromatography/mass spectrometry (IDGC/MS) is a highly accurate technique that is more accessible than NAA techniques. IDGC/MS has been used to determine selenium in foods, plasma and serum, red blood cells, feces, urine, and human breast milk (Lewis 1988). The minimum sample size per determination is 0.5–10 g (0.5–10 mL). In the IDGC/MS method, a stable selenium isotope is added to the sample prior to digestion. This procedure eliminates the need for quantitative sample preparation and external standardization (Lewis 1988). However, a disadvantage of this technique is that enriched isotopic standards are expensive.

NAA techniques provide lower detection limits for selenium (between 10^{-8} and 10^{-9} g selenium per gram of sample), but there are few reactors at which NAA facilities and expertise are available (Koirtyohann and Morris 1986). The most common NAA procedure for selenium determination is to produce the long-lived ^{75}Se radionuclide (half-life of 119 days) and count the samples after a 50–100-hour irradiation period and a 2–10-week cooling period. A faster NAA technique utilizes metastable $^{77\text{m}}\text{Se}$, which has a much shorter half-life (17.4 seconds), so that counting can be initiated after an irradiation and cooling period of <1 minute (Koirtyohann and Morris 1986). The most common standard reference sample for NAA techniques is bovine liver tissue (Bem 1981). Biological tissues that can be analyzed for selenium using the NAA technique include bone, hair, liver, kidney, lung, serum, blood, feces, urine, brain, stomach, skin, aorta, heart, testis, pituitary gland, tooth enamel, tongue, muscle, spleen, and thyroid (Yukawa et al. 1980). For many NAA techniques, destructive sample pretreatment (involving radiochemical separation) is required to avoid interference from the biological matrix (Koirtyohann and Morris 1986). The advantages of NAA are its low detection limits and multielement capability (Molokhia et al. 1979). Because facilities at which NAA can be performed are extremely limited, NAA's most useful application is as a reference method against which other less expensive and more common methods can be compared for accuracy.

Spectrophotometric, fluorometric, voltammetric, and x-ray fluorescence analysis methods have also been successfully employed to determine selenium levels in blood, tissue, and human hair. Of these,

7. ANALYTICAL METHODS

fluorometric methods are most commonly used (Koh and Benson 1983). The reaction of selenium(VI) with 2,3-diaminonaphthalene (DAN) or with 3,3-diaminobenzidine (DAB) to form a fluorescent Se-DAN or Se-DAB heterocyclic compound is the basis of the fluorometric method of selenium determination (Allaway and Cary 1964; Chen et al. 1982; Lewis 1988). The piaszelenol formed with DAN as the reagent has greater fluorescence sensitivity than the piaszelenol formed with DAB as the reagent and is also extractable into organic solvents from acid solution (Chen et al. 1982). Fluorometric techniques require sample digestion to destroy organic matter and sample reduction to convert the selenium to the selenium(IV) oxidation state (Macpherson et al. 1988). Loss of volatile selenium compounds is possible during sample digestion and manipulation because several steps are required. Chen et al. (1982), Hasunuma et al. (1982), and Koh and Benson (1983) developed modifications of the digestion and treatment steps for selenium determination by fluorometric methods. Their methods allow small sample sizes, can be performed in a single flask, and measure submicrogram amounts of selenium.

Some of the methods for determining selenium in biological materials have been compared within the same laboratory for accuracy and precision. Macpherson et al. (1988) compared the accuracy of three methods for the determination of selenium in biological fluid samples from biological materials with certified selenium levels. Acid decomposition fluorometry, HGAAS, and EAAS gave equally accurate results. Lewis et al. (1986) compared the graphite furnace atomic absorption spectrometry with the Zeeman-effect background correction (ZAAS) to isotope dilution mass spectrometry (IDMS) for determination of selenium in plasma and concluded that the ZAAS method compared favorably (correlation coefficient 0.987), but was half as precise as the IDMS method. Oster and Prellwitz (1982) compared HGAAS and GFAAS for the determination of selenium in serum. They concluded that the two techniques exhibited approximately equal detection limits in their laboratory.

In three studies that compared analytical methods for the detection of selenium in biological samples, all found that fluorometry gave both accurate and reliable results (Burguera et al. 1990; Heydorn and Griepink 1990; Macpherson et al. 1988). Burguera et al. (1990) indicated the acceptance of HGAAS as yielding reliable results, whereas Heydorn and Griepink (1990) reported HGAAS had a high relative standard deviation of 11.4%.

Decomposition procedures have been improved and analytical methods have been modified in recent years to increase the accuracy and speed of determination of selenium concentrations in plasma, serum, and urine. Reamer and Veillon (1983) used phosphoric acid along with nitric acid and hydrogen peroxide in digestion of biological fluids instead of perchloric acid to prepare samples for fluorometry. They

7. ANALYTICAL METHODS

concluded that phosphoric acid digestion increases the safety and convenience of the determination. Krynitsky (1987) used a modified wet digestion method for the determination of selenium in biological samples such as eggs and liver of avian species. This method uses hydrogen peroxide to enhance the solubility of the sample. Digestion with HNO_3 and HClO_4 is essential for accurate analysis of the total selenium in urine to ensure complete oxidation of the trimethylselenonium ion (Koh and Benson 1983).

7.2 ENVIRONMENTAL SAMPLES

Many of the basic analytical methods used for determining selenium in biological media are also used for determining selenium levels in soil, water, and air. Precautions in the collection and storage of environmental samples, however, are necessary to prevent loss of the volatile selenium compounds to the air. The destruction of organic matter before selenium measurement is also often necessary.

Acidification of water samples to a pH of 1.5 is recommended to preserve selenium compounds (Muñoz Olivas et al. 1994). Nitric acid can be used, although it interferes with the hydride generation method of analysis. The best storage method for selenium compounds in water is in glass containers at 4 °C (Wiedmeyer and May 1993).

The analytic methods generally fall into two groups: (1) those that do not require the destruction of organic materials in the sample and (2) those that require the elimination of interfering matter before the selenium content can be measured. X-ray fluorescence and some of the neutron activation analysis techniques do not require sample destruction, whereas spectrophotometry, GC, atomic absorption spectrometry, polarography, titration, spark source, MS, fluorometry, and other neutron activation analysis techniques require some degree of sample destruction. Fluorometry, atomic absorption spectrometry, and neutron activation analysis are the most frequently used methods.

Inductively coupled plasma (ICP) emission techniques can be used to measure selenium concentrations. ICP techniques offer multielement capabilities, but instrumentation is costly and background interference can be a problem (Koirtzohann and Morris 1986). The NIOSH-recommended method for determining selenium in air is inductively coupled argon plasma atomic emission spectroscopy (NIOSH 1994a). Selenium may be measured in water following NIOSH Method 7300. The limit of detection for this method is 21 ng/mL using a selenium emission line at 190.6 nm (NIOSH 2001). ICP-MS has been used to determine the concentration of selenium in cloud water at detection limits of 100 and 25 pg/mL using pneumatic and ultrasonic nebulization, respectively (Richter et al. 1998).

7. ANALYTICAL METHODS

AAS techniques are commonly used for the determination of selenium in environmental samples. Hydride generation AAS is more sensitive than flame or graphite furnace AAS for the determination of selenium in materials of variable composition. Water samples, including freshwater, river water, sea water, and surface waters, and industrial wastes, muds, sediments, and soil samples have been analyzed by AAS techniques to detect selenium at parts-per-trillion levels (Bem 1981). Selenium(VI) and selenium(IV) can be distinguished in water samples with GFAAS by selective extraction procedures. HGAAS can also be used to distinguish between selenium(VI) and selenium(IV) in environmental samples because selenium(VI) does not readily form the hydride without reduction (Koirtyohann and Morris 1986). Selenium(VI) is calculated on the basis of the total selenium minus selenium(IV) (Bem 1981).

NAA has been used to determine selenium levels in environmental samples. Dams et al. (1970) reported a detection limit of 1×10^{-10} g/m³ selenium using nondestructive NAA for determining selenium in air particulate matter. For determining selenium levels in soil, radiochemical variants of NAA have been commonly employed (Bem 1981). Instrumental neutron activation analysis (INAA) is frequently used to determine selenium concentrations in water and can also be used to distinguish between selenium(IV) and selenium(VI) oxidation states (Bem 1981). INAA is also used to determine selenium concentrations in air (Bem 1981).

Gas liquid chromatography allows for elimination of interference from the matrix when analyzing environmental samples. When analyzing biological samples, a variety of reagents can be used to convert selenium to piasselenols for measurement with an electron capture detector. Spectrophotometric determinations of selenium are performed using organic reagents, whereas fluorometric analysis relies on piasselenol fluorescence to measure submicrogram levels of the element.

The hydride generation GC with photoionization detection (HGGC-PD) method for selenium determination was developed by Vien and Fry (1988). The combined usage of a photoionization detector and a cold trap provided at least two orders of magnitude improvement in detectability over the existing GC systems. The detection limit for the HGGC-PD method was 1×10^{-12} g selenium/mL (0.001 ppb) for 28 mL samples. An advantage of the HGGC-PD technique is the ability to perform simultaneous determinations of at least four different hydride-forming elements (Vien and Fry 1988).

7. ANALYTICAL METHODS

EPA's Contract Laboratory Program (EPA 1984b) requires the participating laboratories to meet the Contract Required Detection Level (CRDL) for selenium of 5×10^{-9} g selenium/mL (5 μ g selenium/L) using proven instruments and approved analytical techniques, including ICP and atomic absorption methods.

7.3 ADEQUACY OF THE DATABASE

Section 104(i)(5) of CERCLA, as amended, directs the Administrator of ATSDR (in consultation with the Administrator of EPA and agencies and programs of the Public Health Service) to assess whether adequate information on the health effects of selenium is available. Where adequate information is not available, ATSDR, in conjunction with the National Toxicology Program (NTP), is required to assure the initiation of a program of research designed to determine the health effects (and techniques for developing methods to determine such health effects) of selenium.

The following categories of possible data needs have been identified by a joint team of scientists from ATSDR, NTP, and EPA. They are defined as substance-specific informational needs that if met would reduce the uncertainties of human health assessment. This definition should not be interpreted to mean that all data needs discussed in this section must be filled. In the future, the identified data needs will be evaluated and prioritized, and a substance-specific research agenda will be proposed.

7.3.1 Identification of Data Needs

Methods for Determining Biomarkers of Exposure and Effect.

Exposure. Methods that distinguish among the various selenium compounds are not commonly used to estimate human exposure to selenium, but have been used in specialized metabolic studies. Analytical methods currently used to measure concentrations of selenium in biological fluids or human tissue samples as an indication of human exposure are described in Table 7-1. Attempts to use measures of whole blood GPX activity levels as indicators of human exposure to selenium have not been successful. Errors can result if the selenium-dependent GPX activity is not distinguished from the nonselenium-dependent GPX activity (Edwards and Blackburn 1986). In addition, whole blood selenium concentrations and GPX activity appear to correlate with one another only at low blood selenium levels (<0.100 mg selenium/L) (Allaway et al. 1968; Valentine et al. 1980). GPX activity levels measured in

7. ANALYTICAL METHODS

platelets have provided an indication of selenium exposure levels at low blood selenium levels (Nève et al. 1988). Whether platelet GPX activity levels would provide an indication of selenium status in populations with plasma selenium levels above 0.012 mg selenium/L is not known. There is great variability in the exposure data available for humans. Therefore, until larger databases of selenium concentrations in biological materials from affected and unaffected populations are available, no recommendations for analytical methods can be made.

Effect. There are no known sensitive and specific biomarkers of effect for selenium. Therefore, no analytical methods recommendations can be made for biomarkers of effect for selenium, at the present time.

Methods for Determining Parent Compounds and Degradation Products in Environmental

Media. Numerous analytical methods are available for the determination of selenium levels in environmental media (AOAC 1984; Bem 1981; Dams et al. 1970; DOE 1987; EPA 1984b, 1986c; Koirtiyohann and Morris 1986; NIOSH 1994a; Vien and Fry 1988). However, most of these do not distinguish among the various selenium compounds. Many of the available methods can be used to detect selenium at subnanogram levels. For the determination of selenium only, fluorometry, chromatography, or spectrometry are the preferred techniques. When conducting a multielemental analysis or when analyzing a complex matrix, more sophisticated methods are required.

It is possible to detect selenium levels as low as 1 ng/m³ of air using neutron activation analysis. Standardized methods for selenium determination in different environmental samples such as water, soil, sludge, and industrial waste are available in the above-mentioned literature.

There are fewer methods available for distinguishing among the inorganic forms of selenium in the environment. HGAAS, INAA, and GFAAS with selective extraction procedures can be used to distinguish between selenium(VI) and selenium(IV) in samples of soil and water. Methods for determining selenium sulfide levels in the environment are lacking, but would be useful for the identification and measurement of this potentially carcinogenic selenium compound.

Very limited information is available regarding the sensitivity, reliability, and specificity of the existing methods. Further studies to determine these factors would be useful.

7.3.2 Ongoing Studies

N.J. Miller-Ihli and coworkers at the Agricultural Research Service (Beltsville, Maryland) are conducting studies to develop single and multielement methods for the determination of trace elements of nutritional and health concern (e.g., selenium). Some techniques proposed in their studies include: GFAAS and electrothermal vaporization inductively coupled plasma-mass spectrometry (ICP-MS); inductively coupled plasma-atomic emission spectrometry (ICP-AES); electrothermal vaporization ICP-MS (USS-ETV-ICP-MS) and USS-GFAAS; and capillary zone electrophoresis (CZE) coupled with ICP-MS (FEDRIP 2002).

8. REGULATIONS AND ADVISORIES

Because of its potential to cause adverse health effects in exposed people, a number of regulations and guidelines have been established for selenium by various national and state agencies. These values are summarized in Table 8-1.

The current Recommended Dietary Allowances (RDAs) for selenium, established by the Food and Nutrition Board of the National Research Council (National Academy of Sciences) (NAS 2000), are listed below. The recommended Tolerable Upper Intake Level (UL) for selenium in adults is 0.4 mg/day (NAS 2000). The UL is defined as the highest level of daily nutrient intake that is likely to pose no risk of adverse health effects to almost all individuals in the general population.

Men: 0.055 mg/day

Women: 0.055 mg/day

Pregnant women: 0.060 mg/day

Lactating women: 0.070 mg/day

Infants (0–6 months): 0.015 mg/day

Infants (7–12 months): 0.020 mg/day

Children (1–3 years): 0.020 mg/day

Children (4–8 years): 0.030 mg/day

Children (9–18 years): 0.040 mg/day

A chronic oral MRL of 0.005 mg/kg/day was derived for selenium based on a NOAEL of 0.015 mg/kg/day for disappearance of symptoms of selenosis in recovering individuals (Yang and Zhou 1994), as discussed in Section 2.3. The NOAEL was divided by an uncertainty factor of three to account for sensitive individuals. The EPA used the same human NOAEL for clinical selenosis (0.015 mg/kg/day) (Yang et al. 1989a, 1989b) and an uncertainty factor of three to derive a chronic oral reference dose (RfD) of 0.005 mg/kg/day for selenium (EPA 2003).

8. REGULATIONS AND ADVISORIES

Table 8-1. Regulations and Guidelines Applicable to Selenium

Agency	Description	Information	References
INTERNATIONAL			
Guidelines:			
IARC	Carcinogenicity classification	Group 3 ^a	IARC 2001
WHO	Guideline for drinking water Recommended daily intake for adults	0.01 mg/L 0.9 µg/kg body weight	WHO 2001
NATIONAL			
Regulations and Guidelines:			
a. Air			
ACGIH	TLV (8-hour TWA) Selenium and compounds Selenium hexafluoride	0.2 mg/m ³ 0.16 mg/m ³	ACGIH 2000
EPA	Hazard rank under Section 112(g) of the Clean Air Act Amendments Reference air concentration	42 out of 1–100, with 100 being the most toxic 3.0 µg/m ³	EPA 2001a EPA 2001b 40CFR 266, Appendix IV
NIOSH	REL (TWA) Selenium and compounds, except selenium hexafluoride	0.2 mg/m ³	NIOSH 2001
OSHA	IDLH Selenium and compounds General industry PEL (TWA) Selenium and compounds Selenium hexafluoride Hydrogen selenide Construction industry PEL (TWA) Selenium and compounds Selenium hexafluoride	1.0 mg/m ³ 0.2 mg/m ³ 0.4 mg/m ³ 0.2 mg/m ³ 0.2 mg/m ³ 0.16 mg/m ³	OSHA 2001 29CFR1910.1000, Table Z OSHA 2001
b. Water			
EPA	MCLG	0.05 mg/L	EPA 2001c 40CFR141.51
	MCL	0.05 mg/L	EPA 2001d 40CFR141.62
	DWEL	0.2 mg/L	EPA 2000
	Health advisory—lifetime Groundwater monitoring (PQL)	0.05 mg/L 750 µg/L	EPA 2001e 40CFR264, Appendix IX
	Groundwater monitoring— concentration limits	0.01 mg/L	EPA 2001f 40CFR264.94

8. REGULATIONS AND ADVISORIES

Table 8-1. Regulations and Guidelines Applicable to Selenium

Agency	Description	Information	References
NATIONAL (cont.)			
EPA	Water quality standards		EPA 2001g
	Freshwater		40CFR131.36
	Maximum concentration	20 µg/L	
	Continuous concentration	5.0 µg/L	
	Saltwater		
	Maximum concentration	290 µg/L	
	Continuous concentration	71 µg/L	
c. Food			
FDA	Approved use of selenium as a food additive in animal feeds—added to feed for chickens, swine, turkeys, sheep, cattle, and ducks	≤0.3 ppm	FDA 2001a 21CFR573.920
	Bottled water—allowable level	0.05 mg/L	FDA 2001b 21CFR165.110
	RDA (mg/day)		NAS 2000
	Men	0.055	
	Women	0.055	
	Pregnant women	0.060	
	Lactating women	0.070	
	Infants (0–6 months)	0.015	
	Infants (7–12 months)	0.020	
	Children (1–3 years)	0.020	
	Children (4–8 years)	0.030	
	Children (9–18 years)	0.040	
	d. Other		
EPA	Carcinogenicity classification		IRIS 2001
	Selenium and compounds	Group D ^b	
	Selenium sulfide	Group B2 ^c	
	Designation of hazardous substances		EPA 2001h 40CFR116.4
	Selenium oxide		
	Sodium selenite		
	Determination of reportable quantities		EPA 2001i 40CFR117.3
	Selenium oxide	10 pounds	
	Sodium selenite	100 pounds	
	Extremely hazardous substance		EPA 2001j 40CFR355, Appendix B
	Reportable quantity		
	Hydrogen selenide	10 pounds	
	Selenious acid	10 pounds	
	Selenium oxychloride	500 pounds	
Threshold planning quantity			
Hydrogen selenide	10 pounds		
Selenious acid	1,000/10,000 pounds		
Selenium oxychloride	500 pounds		

8. REGULATIONS AND ADVISORIES

Table 8-1. Regulations and Guidelines Applicable to Selenium

Agency	Description	Information	References
NATIONAL (cont.)			
EPA	Identification and listing of hazardous waste		EPA 2001k 40CFR261, Appendix VIII
	Selenium		
	Selenium and compounds		
	Selenium dioxide		
	Selenium sulfide		
	Selenium tetrakis, (dimethyl-dithiocarbamate)		
	Selenious acid		
	Selenourea		
	Thallium selenite		
	Protection standards at inactive uranium processing sites—listed constituents		
	Selenium and compounds		
	Selenium dioxide		
	Selenium sulfide		
	Recommended daily allowances		EPA 2001m
	Selenium and compounds		
	Men	0.7x10 ⁻¹ mg/kg/day	
	Women	0.55x10 ⁻¹ mg/kg/day	
	Infants	8.7x10 ⁻⁴ mg/kg/day	
	Reportable quantity		EPA 2001n 40CFR302.4, Appendix A
	Selenium and compounds	1 pound	
Selenium dioxide	1,000 pounds		
Selenium sulfide	1 pound		
Selenious acid	1 pound		
Selenourea	1 pound		
Sodium selenite	1,000 pounds		
Thallium selenite	1 pound		
Reportable quantity		EPA 2001o 40CFR117.3	
Selenium oxide	10 pounds		
Sewer sludge—disposal or use standards		EPA 2001p 40CFR503.13	
Ceiling concentration	100 mg/kg		
Cumulative pollutant loading rate	100 kg/hectare		
Pollutant concentration ^d	100 mg/kg		
Annual pollutant loading rate	5.0 kg/hectare per 365-day period		
Toxic chemical release reporting; Community Right-to-Know; effective date	01/01/87	EPA 2001q 40CFR372.65	
STATE			
Regulations and Guidelines:			
a. Air			
Hawaii	HAP		BNA 2001

8. REGULATIONS AND ADVISORIES

Table 8-1. Regulations and Guidelines Applicable to Selenium

Agency	Description	Information	References
<i>STATE (cont.)</i>			
Illinois	Toxic air contaminant		BNA 2001
Kansas	HAP		BNA 2001
Kentucky	HAP		BNA 2001
Maryland	Toxic air pollutant Selenium sulfide		BNA 2001
Minnesota	HAP threshold—de minimis level Selenium compounds Selenium sulfide	0.1 ton/year 0.1 ton/year	BNA 2001
Nebraska	HAP—effective date	12/15/98	BNA 2001
New Hampshire	Regulated toxic air pollutant		BNA 2001
New Mexico	Toxic air pollutant OEL Emissions	0.2 mg/m ³ 0.0133 mg/m ³	BNA 2001
New York	HAP—selenium compounds		BNA 2001
Rhode Island	HAP		BNA 2001
South Carolina	Toxic air emissions—maximum allowable concentration Selenium compounds	1 µg/m ³	BNA 2001
Vermont	Hazardous ambient air standards Annual average Action level	4.80 µg/m ³ 0.40 pounds/8-hours	BNA 2001
Washington	HAP—threshold levels Selenium and compounds Selenium hexafluoride Selenium sulfides	0.5 tons/year 0.5 tons/year 0.5 tons/year	BNA 2001
b. Water			
Alabama	Aquatic life criteria Freshwater Acute Chronic Marine Acute Chronic MCL Primary drinking water standard	20 µg/L 5.0 µg/L 300 µg/L 71 µg/L 0.05 mg/L 0.01 mg/L	BNA 2001 BNA 2001
Alaska	Groundwater cleanup level MCL	0.05 mg/L 0.05 mg/L	BNA 2001 BNA 2001
Arizona	Aquifer water quality standards Drinking water guideline MCL Water quality standards Conversion factor ^e for saltwater—acute criteria Conversion factor ^e for saltwater—chronic criteria	0.05 mg/L 45 µg/L 0.05 mg/L 0.998 0.998	BNA 2001 HSDB 2001 BNA 2001 EPA 2001r 40CFR131.38

8. REGULATIONS AND ADVISORIES

Table 8-1. Regulations and Guidelines Applicable to Selenium

Agency	Description	Information	References
<u>STATE (cont.)</u>			
Colorado	Groundwater protection—MCL	0.01 mg/L	BNA 2001
	MCL	0.05 mg/L	BNA 2001
	Primary drinking water standard	0.01 mg/L	BNA 2001
Connecticut	MCL	0.05 mg/L	BNA 2001
Delaware	Groundwater protection—MCL	0.01 mg/L	BNA 2001
	Primary drinking water standard	0.01 mg/L	BNA 2001
Florida	MCL	0.05 mg/L	BNA 2001
Georgia	MCL	0.05 mg/L	BNA 2001
Hawaii	MCL	0.05 mg/L	BNA 2001
	Water quality criteria applicable to all waters		BNA 2001
	Freshwater		
	Acute	20 µg/L	
	Chronic	5.0 µg/L	
	Saltwater		
	Acute	300 µg/L	
Chronic	71 µg/L		
Illinois	Concentration shall not be exceeded in water	1.0 mg/L	BNA 2001
	Groundwater quality standard	0.01 mg/L	BNA 2001
	MCL	0.05 mg/L	BNA 2001
Indiana	MCLG	0.05 mg/L	BNA 2001
	MCL	0.05 mg/L	BNA 2001
Iowa	MCL	0.05 mg/L	BNA 2001
Kansas	Surface water quality standard		BNA 2001
	Aquatic life		
	Acute	20 µg/L	
	Chronic	5.0 µg/L	
	Agriculture		
	Livestock	50 µg/L	
	Irrigation	20 µg/L	
	Public health food		
Procurement	6,800 µg/L		
Domestic water supply	50 µg/L		
Kentucky	Domestic water supply use—maximum allowable instream concentration	0.05 mg/L	BNA 2001
	MCL	0.05 mg/L	BNA 2001
	Maximum groundwater contaminant level	0.01 mg/L	BNA 2001
Kentucky	Primary drinking water standard	0.01 mg/L	BNA 2001
	Warm water aquatic habitat criteria		BNA 2001
	Acute		
Chronic	20 µg/L 5.0 µg/L		

8. REGULATIONS AND ADVISORIES

Table 8-1. Regulations and Guidelines Applicable to Selenium

Agency	Description	Information	References
<u>STATE (cont.)</u>			
Louisiana	Groundwater protection—MCL	0.01 mg/L	BNA 2001
Maine	Drinking water guideline	10 µg/L	HSDB 2001
Maryland	Criteria for toxic substances in surface waters		BNA 2001
	Freshwater		
	Acute	20 µg/L	
	Chronic	5.0 µg/L	
	Saltwater		
	Acute	300 µg/L	
	Chronic	71 µg/L	
	Drinking water	50 µg/L	
	MCL	0.05 mg/L	BNA 2001
	Primary drinking water standard	0.01 mg/L	BNA 2001
Massachusetts	Environmental toxicity values		BNA 2001
	Freshwater		
	Acute	20 µg/L	
	Chronic	5.0 µg/L	
	Marine		
	Acute	300 µg/L	
	Chronic	71 µg/L	
	Groundwater protection—MCL	0.01 mg/L	BNA 2001
	MCL	0.05 mg/L	BNA 2001
Michigan	MCL	0.05 mg/L	BNA 2001
	Effective date	07/30/92	
Minnesota	Drinking water guideline	30 µg/L	HSDB 2001
Mississippi	Groundwater standard	50 ppb	BNA 2001
	Water quality criteria—concentration shall not exceed	0.01 mg/L	BNA 2001
Montana	MCL	0.05 mg/L	BNA 2001
North Carolina	Fresh surface water quality standard for Class C waters	5.0 µg/L	BNA 2001
	Groundwater quality standard	0.05 mg/L	BNA 2001
Nebraska	Aquatic life		BNA 2001
	Acute	20 µg/L	
	Chronic	5.0 µg/L	
	Water supply	0.05 mg/L	BNA 2001
	MCL	0.05 mg/L	BNA 2001
New Hampshire	Groundwater quality standard	0.05 mg/L	
	MCLG	0.05 mg/L	BNA 2001
	MCL	0.05 mg/L	

8. REGULATIONS AND ADVISORIES

Table 8-1. Regulations and Guidelines Applicable to Selenium

Agency	Description	Information	References
<u>STATE (cont.)</u>			
New Hampshire	Water quality criteria		BNA 2001
	Protection of aquatic life		
	Fresh		
	acute	5.0 µg/L	
	chronic	290µg/L	
	Marine		
	acute	71 µg/L	
chronic	170 µg/L		
	Protection of human health		
	Water and fish ingestion	11,000 µg/L	
New Mexico	MCL	0.05 mg/L	BNA 2001
Nevada	Domestic water supply		BNA 2001
	Dissolved selenium	0.05 mg/L	
New York	MCL	0.05 mg/L	BNA 2001
North Dakota	MCL	0.05 mg/L	BNA 2001
Ohio	Groundwater concentration limit	0.01 mg/L	BNA 2001
Oklahoma	Public and private water supplies	0.01 mg/L	BNA 2001
	Fish and wildlife propagation		BNA 2001
	Acute	20 µg/L	
	Chronic	5.0 µg/L	
Rhode Island	Groundwater quality standard	0.05 mg/L	BNA 2001
	Preventive action limit	0.025 mg/L	
South Carolina	MCL	0.05 mg/L	BNA 2001
South Dakota	Groundwater maximum allowable concentration	0.05 mg/L	BNA 2001
	Aquatic life value		
	Acute	20 µg/L	
	Chronic	5.0 µg/L	
Tennessee	Groundwater criteria concentration	0.05 mg/L	BNA 2001
	MCL	0.05 mg/L	
Texas	MCL	0.05 mg/L	BNA 2001
Utah	MCL	0.05 mg/L	BNA 2001
	Water quality		
	Domestic	0.01 mg/L	
	Agriculture	0.05 mg/L	
Vermont	Groundwater quality standards		BNA 2001
	Enforcement standard	50 µg/L	
	Preventive action level	25 µg/L	
	MCLG	0.05 mg/L	
	MCL	0.05 mg/L	BNA 2001

8. REGULATIONS AND ADVISORIES

Table 8-1. Regulations and Guidelines Applicable to Selenium

Agency	Description	Information	References
<i>STATE (cont.)</i>			
Vermont	Water quality criteria for protection of aquatic organisms Maximum allowable concentration Acute Average allowable concentration Chronic	20 µg/L 5.0 µg/L	BNA 2001
Virginia	Groundwater protection levels Protection level Monitoring level MCL Surface water criteria Freshwater Acute Chronic Saltwater Acute Chronic Human health Public water supplies All other surface waters	10 µg/L 5.0 µg/L 0.01 mg/L 20 µg/L 5.0 µg/L 300 µg/L 71 µg/L 170 µg/L 11,000 µg/L	BNA 2001 BNA 2001 BNA 2001 BNA 2001
Washington	MCL	0.05 mg/L	BNA 2001
Wisconsin	Groundwater quality standards Enforcement standard Preventive action limit MCL	50 µg/L 10 µg/L 0.05 mg/L	BNA 2001 BNA 2001 BNA 2001
Wyoming	Water quality Aquatic life Acute Chronic Human health	20 µg/L 5.0 µg/L 10 µg/L	BNA 2001
c. Food			
New York	Bottled water sampling requirements—MCL	0.01 mg/L	BNA 2001
d. Other			
Alabama	Identification and listing of hazardous waste		BNA 2001
Arizona	Soil remediation levels Residential Non-residential	380 mg/kg 8,500 mg/kg	BNA 2001
California	Hazardous waste injection restrictions—waste specific prohibitions Selenium and/or compounds	100 mg/L	EPA 2001s 40CFR148.12 (b)(2)

8. REGULATIONS AND ADVISORIES

Table 8-1. Regulations and Guidelines Applicable to Selenium

Agency	Description	Information	References
<i>STATE (cont.)</i>			
California	Known to cause cancer or reproductive toxicity—initial appearance of chemical on list Selenium sulfide	10/01/89	BNA 2001
	Total threshold limit concentration	10,000 mg/kg	BNA 2001
Delaware	Regulated toxic substance—sufficient quantity Selenium hexafluoride	900 pounds/hour	BNA 2001
Florida	Toxic substance in the workplace Hydrogen selenium Selenium Selenium hexafluoride Selenium oxychloride Selenium sulfide		BNA 2001
Hawaii	Restricted use pesticides Selenium compounds	All concentrations	BNA 2001
Kentucky	Threshold planning quantity Hydrogen selenide Selenious acid Selenium oxychloride	10 pounds 1,000/10,000 pounds 500 pounds	BNA 2001
Massachusetts	Oil and hazardous material Selenious acid Selenium and compounds Selenium dioxide Selenium disulfide Selenium oxide Selenium oxychloride Selenium sulfide Selenourea		BNA 2001
Minnesota	RfD Health risk limit	0.005 mg/kg/day 30 µg/L	BNA 2001
New Hampshire	Restricted use pesticide	All concentrations	BNA 2001
New Jersey	Extraordinary hazardous substance—threshold quantity Selenium hexafluoride	700 pounds	BNA 2001

8. REGULATIONS AND ADVISORIES

Table 8-1. Regulations and Guidelines Applicable to Selenium

Agency	Description	Information	References
<i>STATE (cont.)</i>			
Oregon	Toxic substance—de minimis concentration	1.0 percent	BNA 2001
Vermont	Restricted use pesticide Selenium and compounds	All concentrations	BNA 2001

^aGroup 3: not classifiable as to its carcinogenicity to humans

^bGroup D: not classifiable as to its carcinogenicity to humans

^cGroup B2: probable human carcinogen

^dMonthly average concentrations

^eConversion factors are based on a hardness of 100 mg/L as calcium carbonate

ACGIH = American Conference of Governmental Industrial Hygienists; BNA = Bureau of National Affairs; CFR = Code of Federal Regulations; DWEL = drinking water equivalent level; EPA = Environmental Protection Agency; FDA = Food and Drug Administration; HAP = hazardous air pollutant; IARC = International Agency for Research on Cancer; IDLH = immediately dangerous to life and health; IRIS = Integrated Risk Information System; MCL = maximum contaminant level; MCLG = maximum contaminant level goal; NIOSH = National Institute for Occupational Safety and Health; OEL = occupational exposure limit; OSHA = Occupational Safety and Health Administration; PEL = permissible exposure limit; PQL = practical quantitation limit; RDA = recommended daily allowance; REL = recommended exposure limit; RfD = reference dose; TLV = threshold limit value; TWA = time-weighted average; WHO = World Health Organization

9. REFERENCES

- *Aaseth J, Frey H, Glattre E. 1990. Selenium concentrations in the human thyroid gland. *Biol Trace Elem Res* 24(2):147-152.
- Abdel-Azeem EA. 1996. Selenium cytotoxicity in root meristems of vicia faba l. *Al-Azhar Bull Sci* 7(1):401-409.
- *Abdelrahman MM, Kincaid RL. 1995. Effect of selenium supplementation of cows on maternal transfer of selenium to fetal and newborn calves. *J Dairy Sci* 78:625-630.
- Abo-Elkhier ZA, El-Shafy EA. 2000. Chromosomal alterations in mitotic division induced by selenium pollutants. *Egypt J Biotechnol* 7:1-11.
- ACGIH. 1994. Documentation of the threshold limit values and biological exposure indices. American Conference of Governmental Industrial Hygienists, Cincinnati, OH.
- *ACGIH. 2000. 2000 TLVs and BEIs. Threshold limit values and biological exposure indices. American Conference of Governmental Industrial Hygienists, Cincinnati, OH.
- *Adams WJ. 1976. The toxicity and residue dynamics of selenium in fish and aquatic invertebrates. Dissertation submitted to Michigan State University, Department of Fisheries and Wildlife.
- Adeloju SB, Bond AM, Briggs MH. 1984. Critical evaluation of some wet digestion methods for the stripping voltammetric determination of selenium in biological materials. *Anal Chem* 56:2397-2401.
- *Adinolfi M. 1985. The development of the human blood-CSF-brain barrier. *Dev Med Child Neurol* 27:532-537.
- *Adkins RL, Walsh N, Edmunds M, et al. 1995. Inductively coupled plasma atomic emission spectrometric analysis of low levels of selenium in natural waters. *Analyst* 120:1433-1436.
- *Adlercreutz H. 1995. Phytoestrogens: Epidemiology and a possible role in cancer protection. *Environ Health Perspect Suppl* 103(7):103-112.
- *Agency for Toxic Substances and Disease Registry. 1989. Decision guide for identifying substance-specific data needs related to toxicological profiles; Notice. Agency for Toxic Substances and Disease Registry. *Federal Register* 54(174):37618-37634.
- *Agency for Toxic Substances and Disease Registry. 1990. Biomarkers of organ damage or dysfunction for the renal, hepatobiliary, and immune systems. Atlanta, GA: Subcommittee on Biomarkers of Organ Damage and Dysfunction, Agency for Toxic Substances and Disease Registry.
- Aggarwal SK, Kinter M, Herold DA. 1992. Determination of selenium in urine by isotope dilution gas chromatography-mass spectrometry using 4-nitro-o-phenylenediamine, 3,5-dibromo-o-phenylenediamine, and 4-trifluoromethyl-o-phenylenediamine as derivatizing reagents. *Anal Biochem* 202(2):367-374.

* Cited in text

9. REFERENCES

- *Alabdula'aly AI, Khan MA. 2000. Chemistry of rain water in Riyadh, Saudi Arabia. *Arch Environ Contam Toxicol* 39:66-73.
- Al-Awadi FM, Srikumar TS. 2001. Determination of selenium concentration and its chemical forms in the milk of Kuwaiti and non-Kuwaiti lactating mothers. *J Trace Elem Exp Med* 14(1):57-67.
- Albrecht F. 1998. Selenium, building nutritional defenses. *Nat Pharm* 2:22-23.
- *Al-Bayati MA, Raabe OG, Teague SV. 1992. Effect of inhaled dimethylselenide in Fisher 344 male rat. *J Toxicol Environ Health* 37(4):549-557.
- *Alfthan G. 1985. Can externally deposited selenium be removed from hair? [Letter]. *Clin Chem* 31:500.
- Alfthan G, Penttila A. 1988. Effect of fat on human liver selenium concentration. *Biol Trace Elem Res* 18:137-143.
- Alfthan G, Aro A, Arvilommi H, et al. 1991. Selenium metabolism and platelet glutathione peroxidase activity in healthy Finnish men: Effects of selenium yeast, selenite, and selenate. *Am J Clin Nutr* 53(1):120-125.
- Alfthan G, Bogye G, Aro A, et al. 1992. The human selenium status in Hungary. *J Trace Elem Electrolytes Health Dis* 6(4):233-238.
- *Al-Kunani AS, Knight R, Haswell SJ, et al. 2001. The selenium status of women with a history of recurrent miscarriage. *Br J Obstet Gynaecol* 108(10):1094-1097.
- *Allaway WH, Cary EE. 1964. Determination of submicrogram amounts of selenium in biological materials. *Anal Chem* 36:1359-1362.
- *Allaway WH, Kubota J, Losee F, et al. 1968. Selenium, molybdenum, and vanadium in human blood. *Arch Environ Health* 16:342-348.
- Allen GT, Balckford SH, Tabot VM, et al. 2001. Metals, boron, and selenium in Neosho Madtom habitats in the Neosho River in Kansas, U.S.A. *Environ Monit Assess* 66(1):1-21.
- Al-Saleh I, Al-Doush I, Ibrahim M, et al. 1998. Serum selenium levels in Saudi new-borns. *Int J Environ Health Res* 8:269-275.
- *Altman PL, Dittmer DS. 1974. In: *Biological handbooks: Biology data book*. Vol. III. 2nd ed. Bethesda, MD: Federation of American Societies for Experimental Biology, 1987-2008, 2041.
- Alvarez GH, Capar SG. 1991. Continuous hydride generation-atomic absorption method for the determination of selenium and arsenic in foods. *Analytical Letters* 24(9):1695-1710.
- Ames M, Gullu G, Olmez I. 1998. Atmospheric mercury in the vapor phase, and in fine and coarse particulate matter at Perch River, New York. *Atmos Environ* 32(5):865-872.
- *Amor AJ, Pringle P. 1945. A review of selenium as an industrial hazard. *Bulletin of Hygiene* 20(5):239-241.

9. REFERENCES

- *Andersen ME, Krishnan K. 1994. Relating *in vitro* to *in vivo* exposures with physiologically based tissue dosimetry and tissue response models. In: Salem H, ed. Animal test alternatives: Refinement, reduction, replacement. New York, NY: Marcel Dekker, Inc., 9-25.
- *Andersen ME, Clewell HJ III, Gargas ML, et al. 1987. Physiologically based pharmacokinetics and the risk assessment process for methylene chloride. Toxicol Appl Pharmacol 87:185-205.
- Anderson RS, Trune DR, Shearer TR. 1988. Histologic changes in selenite cortical cataract. Invest Ophthalmol Vis Sci 29(9):1418-1427.
- *Andren AW, Klein DH. 1975. Selenium in coal-fired steam plant emissions. Environ Sci Technol 9:856-858.
- Anema SM, Walker SW, Howie AF, et al. 1999. Thioredoxin reductase is the major selenoprotein expressed in human umbilical-vein endothelial cells and is regulated by protein kinase C. Biochem J 342:111-117.
- Anjaria KB, Madhvanath U. 1988. Genotoxicity of selenite in diploid yeast. Mutat Res 204(4):605-614.
- *AOAC. 1984. Official methods of analysis of the Association of Official Analytical Chemists. Methods 3.101, 3.102-3.107, 25.154, and 25.158. Arlington, VA: Association of Official Analytical Chemists.
- Aono T, Nakaguchi Y, Hiraki K, et al. 1990. Determination of seleno-amino acid in natural water samples. Geochem J 24(4):255-261.
- *Archimbaud Y, Grillon G, Poncy JL, et al. 1992. ⁷⁵Se transfer via placenta and milk, distribution and retention in fetal, young and adult rat. Rad Protect Dos 41(2-4):147-151.
- *Arteel GE, Sies H. 2001. The biochemistry of selenium and glutathion system. Environ Toxicol Pharmacol 10:153-158.
- Arthur JR. 2000. The glutathione peroxidases. Cell Mol Life Sci 57(13/14):1825-1835.
- *Arthur JR, Beckett GJ. 1989. Selenium deficiency and thyroid hormone metabolism. In: Wendel A, ed. Selenium in biology and medicine. New York, NY: Springer-Verlag.
- *Arthur JR, Beckett GF. 1994a. Roles of selenium in Type I iodothyronine 5'-deiodinase and in thyroid hormone and iodine metabolism. In: Burk RF, ed. Selenium in biology and human health. New York, NY: Springer-Verlag, 94-115.
- *Arthur JR, Beckett GJ. 1994b. Symposium 2. Newer aspects of micronutrients in at risk groups. New metabolic roles for Selenium. Proc Nutr Soc 53:615-624.
- Arthur JR, Beckett GJ. 1999. Thyroid function. Br Med Bull 55(3):658-668.
- *Arthur MA, Rubin G, Woodbury PB, et al. 1992. Uptake and accumulation of selenium by terrestrial plants growing on a coal fly ash landfill: Part 2. Forage and root crops. Environ Toxicol Chem 11(9):1289-1299.

9. REFERENCES

- *Arvilommi H, Poikonen K, Jokinen I, et al. 1983. Selenium and immune functions in humans. *Infect Immun* 41(1):185-189.
- Atsuya I, Itoh K, Ariu K. 1991. Preconcentration by coprecipitation of lead and selenium with nickel-pyrrolidine dithiocarbamate complex and their simultaneous determination by internal standard atomic absorption spectrometry with the solid sampling technique. *Pure Appl Chem* 63(9):1221-1226.
- Awadeh FT, Kincaid RL, Johnson KA. 1998. Effect of level and source of dietary selenium on concentrations of thyroid hormones and immunoglobulins in beef cows and calves. *J Anim Sci* 76:1204-1215.
- *Azaizeh HA, Gowthaman S, Terry N. 1997. Microbial selenium volatilization in rhizosphere and bulk soils from a constructed wetland. *J Environ Qual* 26:666-672.
- *Azin F, Raie RM, Mahmoudi MM. 1998. Correlation between the levels of certain carcinogenic and anticarcinogenic trace elements and esophageal cancer in Northern Iran. *Ecotoxicol Environ Saf* 39:179-184.
- *Baglan RJ, Brill AB, Schubert A, et al. 1974. Utility of placenta tissue as an indicator of trace element exposure to adult and fetus. *Environ Res* 8:64-70.
- *Baird RB, Pourian BS, Gabrielian SM. 1972. Determination of trace amounts of selenium in wastewaters by carbon rod atomization. *Anal Chem* 44:1887-1889.
- *Baker DC, James LF, Hartley WJ, et al. 1989. Toxicosis in pigs fed selenium-accumulating *Astragalus* plant species or sodium selenate. *Am J Vet Res* 50(8):1396-1399.
- *Balansky RM. 1991. Comutagenic and coclastogenic effects of selenium *in vitro* and *in vivo*. *Mutat Res* 263(4):231-236.
- Banerjee CK, Sani BP. 1982. Selenium binding proteins in rat tissues. *Biochem Biophys Res Commun* 109:210-216.
- Banholzer E, Heinritzi K. 1998. Selenium toxicosis in fattening pigs. *J Anim Physiol Anim Nutr* 80:158-162.
- *Bansal MP, Cook RG, Danielson KG, et al. 1989. A 14-kilodalton selenium-binding protein in mouse liver is fatty acid-binding protein. *J Biol Chem* 264(23):13780-13784.
- *Bansal MP, Mukhopadhyay T, Scott J, et al. 1990. DNA sequencing of a mouse liver protein that binds selenium: implications for selenium's mechanism of action in cancer prevention. *Carcinogenesis* 11(11):2071-2073.
- *Bañuelos GS, Mayland HF. 2000. Absorption and distribution of selenium in animals consuming canola grown for selenium phytoremediation. *Ecotoxicol Environ Saf* 46:322-328.
- *Banuelos GS, Meek DW. 1990. Accumulation of selenium in plants grown on selenium-treated soil. *J Environ Qual* 19(4):772-777.

9. REFERENCES

- Barbosa NBV, Rocha JBT, Zeni G, et al. 1998. Effect of organic forms of selenium on δ -aminolevulinic acid dehydratase from liver, kidney, and brain of adult rats. *Toxicol Appl Pharmacol* 149:243-253.
- *Barceloux DG. 1999. Selenium. *Clin Toxicol* 37(2):145-172.
- Barceloux DG. 2001. Selenium. *J Toxicol Clin Toxicol* 37:1-39.
- Barlow SM, Sullivan FM, eds. 1982. Reproductive hazards of industrial chemicals. An evaluation of animal and human data. London, UK: Academic Press, 483-500.
- *Barnes DG, Dourson M. 1988. Reference dose (RfD): Description and use in health risk assessments. *Regul Toxicol Pharmacol* 8:471-486.
- *Barrington JW, Lindsay P, James D, et al. 1996. Selenium deficiency and miscarriage: A possible link? *Br J Obstet Gynaecol* 103:130-132.
- *Barrington JW, Taylor M, Bowen-Simpkins P. 1997. Selenium and recurrent miscarriage. *J Obstet Gynaecol* 17(2):199-200.
- Basket CK, Spata VL, Mason MM, et al. 2001. Long-term selenium status in humans. *J Radioanal Nucl Chem* 249(2):429-435.
- Bastug M, Ayhan S, Turan B. 1998. The effect of altered selenium and vitamin E nutritional status on learning and memory of third-generation rats. *Biol Trace Elem Res* 64:151-160.
- *Baum MK, Shor-Posner G, Lai S, et al. 1997. High risk of HIV-related mortality associated with selenium deficiency. *J Acquir Immune Defic Syndr Hum Retrovirol* 15(5):370-374.
- Bauman AT, Barofsky DF, Butler JA, et al. 2000. Evidence of a biomarker for selenium toxicity [Abstract]. *FASEB J* 14(1):513.
- *Bayliss PA, Buchanan BE, Hancock RGV, et al. 1985. Tissue selenium accretion in premature and full-term human infants and children. *Biol Trace Elem Res* 7:55-61.
- *Beale AM, Fasulo DA, Craigmill AL. 1990. Effects of oral and parenteral selenium supplements on residues in meat, milk and eggs. *Rev Environ Contam Toxicol* 115:125-150.
- Beath OA, Draize JH, Gilberg CS. 1934. Plants poisonous to livestock. *Wyoming Agr Expt Sta Bull No* 200:1-84.
- *Beath OA, Hagner AF, Gilbert CS. 1946. Some rocks of high selenium content. *Wyoming Geological Survey Bulletin No.* 36:1-23.
- *Beck MA, Shi Q, Morris VC, et al. 1995. Rapid genomic evolution of a non-virulent coxsackievirus B3 in selenium deficient mice in selection of identical isolates. *Nat Med* 1:433-436.
- *Beems RB. 1986. Dietary selenium and benzo[a]pyrene-induced respiratory tract tumours in hamsters. *Carcinogenesis* 7:485-489.

9. REFERENCES

- Beguin Y, Bours V, Delbrouck JM, et al. 1989. Relationship of serum selenium levels to tumor activity in acute non-lymphocytic leukemia. *Carcinogenesis* 10(11):2089-2091.
- *Behne D, Kyriakopoulos A. 1993. Effects of dietary selenium on the tissue concentrations of type I iodothyronine 5'-deiodinase and other selenoproteins. *Am J Clin Nutr* 57(Suppl.):310S-312S.
- *Behne D, Kyriakopoulos A, Scheid S, et al. 1991. Effects of chemical form and dosage on the incorporation of selenium into tissue proteins in rats. *J Nutr* 121(6):806-814.
- *Behne S, Kyriakopoulos A, Gessner H, et al. 1992. Type I iodothyronine deiodinase activity after high selenium intake, and relations between selenium and iodine metabolism in rats. *J Nutr* 122:1542-1546.
- Beilstein MA, Whanger PD. 1983. Distribution of selenium and glutathione peroxidase in blood fractions from humans, rhesus and squirrel monkeys, rats and sheep. *J Nutr* 113:2138-2146.
- Beilstein MA, Whanger PD. 1986a. Chemical forms of selenium in rat tissues after administration of selenite for selenomethionine. *J Nutr* 116:1711-1719.
- Beilstein MA, Whanger PD. 1986b. Deposition of dietary organic and inorganic selenium in rat erythrocyte proteins. *J Nutr* 116:1701-1710.
- *Beilstein MA, Whanger PD. 1992. Selenium metabolism and glutathione peroxidase activity in cultured human lymphocytes. *Biol Trace Elem Res* 35:105-118.
- *Bell RR, Nonavinakere VK, Soliman MRI. 2000. Intratracheal exposure of the guinea pig lung to cadmium and/or selenium: A histological evaluation. *Toxicol Lett* 114:101-109.
- *Bell RR, Soliman MMRI, Nonavinakere VK, et al. 1997. Selenium and cadmium induced pulmonary functional impairment and cytotoxicity. *Toxicol Lett* 90:107-114.
- Bellisola G, Brätter P, Cinque G, et al. 1998. The TSH-dependent variation of the essential elements iodine, selenium, and zinc within human thyroid tissues. *J Trace Elem Med Biol* 12:177-182.
- *Bem EM. 1981. Determination of selenium in the environment and in biological material. *Environ Health Perspect* 37:183-200.
- *Bender J, Gould JP, Vatcharapijarn Y, et al. 1991. Uptake, transformation and fixation of selenium (VI) by a mixed selenium-tolerant ecosystem. *Water Air Soil Pollut* 59(3-4):359-368.
- *Ben-Porath M, Kaplan E. 1969. The distribution and concentration of ⁷⁵Se-selenomethionine in man. *J Nucl Med* 10:709-710.
- Benton D, Cook R. 1991. The impact of selenium supplementation on mood. *Biol Psychiatry* 29:1092-1098.
- Berg V, Ugland KI, Hareide NR, et al. 2000. Mercury, cadmium, lead, and selenium in fish from a Norwegian fjord and off the coast, the importance of sampling locality. *J Environ Monitor* 2(4):375-377.
- *Berger GS. 1994. Epidemiology of endometriosis. In: Berger GS, ed. *Endometriosis: Advanced management and surgical techniques*. New York, NY: Springer-Verlag.

9. REFERENCES

- Berggren M, Gallegos A, Gasdaska J, et al. 1997. Cellular thioredoxin reductase activity is regulated by selenium. *Anticancer Res* 17:3377-3380.
- *Bergman K, Cekan E, Slanina P, et al. 1990. Effects of dietary sodium selenite supplementation on salicylate-induced embryo- and fetotoxicity in the rat. *Toxicology* 61(2):135-146.
- *Bermejo Barrera PB, Lorenzo Alonso MJL, Bermejo Barrera AB, et al. 2000. Selenium determination in mother and child's hair by electrothermal atomic absorption spectrometry. *Forensic Sci Int* 107:149-156.
- Berry M, Bove F. 1997. Birth weight reduction associated with residence near a hazardous waste landfill. *Environ Health Perspect* 105(8):856-861.
- *Berry MJ, Banu L, Chen Y, et al. 1991. Recognition of UGA as a selenocysteine codon in Type I deiodinase requires sequences in the 3' untranslated region. *Nature* 353:273-276.
- *Besser JM, Canfield TJ, La Point TW. 1993. Bioaccumulation of organic and inorganic selenium in a laboratory food chain. *Environ Toxicol Chem* 12(1):57-72.
- *Besser JM, Giesy JP, Brown RW, et al. 1996. Selenium bioaccumulation and hazards in a fish community affected by coal fly ash effluent. *Ecotoxicol Environ Saf* 35:7-15.
- *Besser JM, Huckins JN, Little EE, et al. 1989. Distribution and bioaccumulation of selenium in aquatic microcosms. *Environ Pollut* 62(1):1-12.
- Biggar JW, Jayaweera GR. 1993. Measurement of selenium volatilization in the field. *Soil Science* 155(1):31-36.
- Bilski JJ, Alva AK. 1995. Transport of heavy metals and cations in a fly ash amended soil. *Bull Environ Contam Toxicol* 55:502-509.
- *Bioulac-Sage P, Dubuisson L, Bedin C, et al. 1992. Nodular regenerative hyperplasia in the rat induced by a selenium-enriched diet: Study of a model. *Hepatology* 16(2):418-425.
- *Birt DF, Julius AD, Runice CE. 1986. Tolerance of low and high dietary selenium throughout the life span of Syrian hamsters. *Ann Nutr Metab* 30:233-240.
- Birt DF, Julius AD, Runice CE, et al. 1988. Enhancement of BOP-induced pancreatic carcinogenesis in selenium-fed Syrian golden hamsters under specific dietary conditions. *Nutr Cancer* 11:21-34.
- *Birt DF, Lawson TA, Julius AD, et al. 1982. Inhibition by dietary selenium of colon cancer induced in the rat by bis(2-oxopropyl) nitrosamine. *Cancer Res* 42:4455-4459.
- Bischoff K, Pichner J, Brasselton WE, et al. 2002. Mercury and selenium concentrations in livers and eggs of common loons (*Gavia immer*) from Minnesota. *Arch Environ Contam Toxicol* 42(1):71-76.
- *Biswas S. 1997. Clastogenic effects of an inorganic selenium salt in human peripheral lymphocytes *in vitro*. *Cell Chromosome Res* 20(2):67-72.

9. REFERENCES

- *Biswas S, Talukder G, Sharma A. 1997. Selenium salts and chromosome damage. *Mutat Res* 390:201-205.
- *Biswas S, Talukder G, Sharma A. 1999a. Comparison of clastogenic effects of inorganic selenium salts in mice *in vivo* as related to concentrations and duration of exposure. *Biotechnology Techniques* 12:361-368.
- *Biswas S, Talukder G, Sharma A. 1999b. Prevention of cytotoxic effects of arsenic by short-term dietary supplementation with selenium in mice *in vivo*. *Mutat Res* 441:155-160.
- *Biswas S, Talukder G, Sharma A. 2000. Chromosome damage induced by selenium salts in human peripheral lymphocytes. *Toxicol in Vitro* 14:405-408.
- Blakley B. 1987. Alterations in urethan-induced adenoma formation in mice exposed to selenium and nickel. *J Appl Toxicol* 7:387-390.
- *Bleau G, Lemarbre J, Faucher G, et al. 1984. Semen selenium and human fertility. *Fertil Steril* 42:890-894.
- *Blincoe C. 1960. Whole-body turnover of selenium in the rat. *Nature* 186:398.
- Blodgett DJ, Bevill RF. 1987a. Acute selenium toxicosis in sheep. *Vet Hum Toxicol* 29:233-236.
- *Blodgett DJ, Bevill RF. 1987b. Pharmacokinetics of selenium administered parenterally at toxic doses in sheep. *Am J Vet Res* 48:530-534.
- *Blot WJ, Li J-Y, Taylor PR, et al. 1993. Nutrition intervention trials in Linxian, China. Supplementation with specific vitamin/mineral combinations, cancer incidence and disease-specific mortality in the general population. *J Natl Cancer Inst* 85(18):1483-1491.
- *Blotcky M, Jetton M, and Sullivan JF. 1979. Organ content of selenium, zinc, magnesium, calcium and copper in alcoholic cirrhotic patients and controls. In: D. Hemphill ed. *Proc. Trace Substances in Environmental Health*. Columbia, MO: University of Missouri.
- *BNA. 2001. Washington, D.C. Environment and Safety Library on the Web States and Territories. Bureau of National Affairs, Inc. <http://www.esweb.bna.com>. February 23, 2001.
- Bonomini M, Forster S, De Risio F, et al. 1995. Effects of selenium supplementation on immune parameters in chronic uraemic patients on haemodialysis. *Nephrol Dial Transplant* 10:1654-1661.
- *Bopp BA, Sonders RC, Kesterson JW. 1982. Metabolic fate of selected selenium compounds in laboratory animals and man. *Drug Metab Rev* 13:271-318.
- Borella P, Bargellini A, Medici CI. 1996. Chemical form of selenium greatly affects metal uptake and responses by cultured human lymphocytes. *Biol Trace Elem Res* 51:43-54.
- Bortoli A, Dell'Andrea E, Gerotto M, et al. 1991. The analytical techniques for total mercury (Hg), methyl mercury (MeHg), and selenium (Se) determination in a fisherman and fishing families group of north Adriatic coast. *Acta Chimica Hungarica* 128(4-5):573-580.

9. REFERENCES

- Bowen WH. 1972. The effect of selenium and vanadium on caries activity in monkeys (*M. irus*). *J Ir Dent Assoc* 18:83-89.
- *Boylan LM, Cogan D, Huffmam N, et al. 1990. Behavioral characteristics in open field testing of mice fed selenium-deficient and selenium-supplemented diets. *J Trace Elem Exp Med* 3:157-165.
- *Bratakos MS, Kanaki HC, Vasiliou-Waite A, et al. 1990. The nutritional selenium status of healthy Greeks [published erratum appears in *Sci Total Environ* 1990 June 95:297]. *Sci Total Environ* 91:161-176.
- *Brätter P, Negretti De Brätter VE. 1996. Influence of high dietary selenium intake on the thyroid hormone level in human serum. *J Trace Elem Med Biol* 10:163-166.
- *Brätter P, Negretti De Brätter VE, Jaffé WG, et al. 1991a. Selenium status of children living in seleniferous areas of Venezuela. *J Trace Elem Electrolytes Health Dis* 5:269-270.
- Brätter P, Negretti De Brätter VE, Recknagel S, et al. 1997. Maternal selenium status influences the concentration and binding pattern of zinc in human milk. *J Trace Elem Med Biol* 11:203-209.
- *Brätter P, Negretti De Brätter VE, Rösick U, et al. 1991b. Selenium in the nutrition of infants: Influence of the maternal selenium status. In: Chandra RK, ed. *Trace elements in nutrition of children-II*. New York, NY: Raven Press, 79-90.
- Brawley OW, Parnes H. 2000. Prostate cancer prevention trials in the USA. *Eur J Cancer* 36:1312-1315.
- *Brigelius-Flohe R. 1999. Tissue-specific functions of individual glutathione peroxidases. *Free Radic Biol Med* 27(9/10):951-965.
- Broghamer WLJ, McConnell KP, Grimaldi M, et al. 1978. Serum selenium and reticuloendothelial tumors. *Cancer* 41:1462-1466.
- Brown MM, Watskinson JH. 1977. An automated fluorimetric method for the determination of nanogram quantities of selenium. *Anal Chim Acta* 89:29.
- Bruce A. 1990. Recommended dietary allowances: The Nordic experience. *Eur J Clin Nutr* 44(Suppl)2:27-29.
- Brumbaugh WG, Walther MJ. 1989. Determination of arsenic and selenium in whole fish by continuous-flow hydride generation atomic absorption spectrophotometry. *J Assoc Off Anal Chem* 72(3):484-486.
- Buchan RF. 1947. Industrial selenosis. *Occup Med* 3:439-456.
- Buchholz BA, Landsberger S. 1995. Leaching dynamics studies of municipal solid waste incinerator ash. *J Air Waste Manage Assoc* 45:579-590.
- Buckley WT, Budac JJ, Godfrey DV, et al. 1992. Determination of selenium by inductively coupled plasma mass spectrometry utilizing a new hydride generation sample introduction system. *Anal Chem* 64(7):724-729.

9. REFERENCES

- *Budavari S, O'Neil MJ, Smith A, et al., eds. 1996. The Merck index: An encyclopedia of chemicals, drugs, and biologicals. 12th ed. Whitehouse Station, NJ: Merck & Co., Inc.
- Burger J, Gaines KF, Boring CS, et al. 2001. Mercury and selenium in fish from the Savannah River: species, trophic level, and locational difference. *Environ Res* 87(2):108-118.
- Burger J, Gochfeld M. 1999. Heavy metals in Franklin's gull tissues: Age and tissue differences. *Environ Toxicol Chem* 18(4):673-678.
- Burger J, Cooper K, Gochfeld M. 1992. Exposure assessment for heavy metal ingestion from a sport fish in Puerto Rico: Estimating risk for local fishermen. *J Toxicol Environ Health* 36(4):355-365.
- Burger J, Woolfenden GE, Gochfeld M. 1999. Metal concentrations in the eggs of endangered Florida scrub-jays from central Florida. *Arch Environ Contam Toxicol* 37:385-388.
- *Burguera JL, Burguera M, Galignani M, et al. 1990. A comparative study of methods for determining selenium in biological materials. *Acta Cient Venez* 41(1):5-10.
- *Burk RF. 1974. *In vivo* ⁷⁵Se binding to human plasma proteins after administration of ⁷⁵SeO₃₋₂. *Biochim Biophys Acta* 372:255-265.
- Burk RF. 1989. Recent developments in trace element metabolism and function: Newer roles of selenium in nutrition. *J Nutr* 119(7):1051-1054.
- Burk RF. 1991. Molecular biology of selenium with implications for its metabolism. *FASEB J* 5(9):2274-2279.
- Burk RF. 1993. Clinical effects of selenium deficiency. *Prog Clin Biol Res* 380:181-190.
- *Burk RF, Hill KE. 2000. Characteristics and function of selenoprotein P. *Trace Elements in Man and Animals*. New York, NY: Plenum Press, 837-842.
- *Burk RF, Brown DG, Seely RJ, et al. 1972. Influence of dietary and injected selenium on whole-body retention, route of excretion, and tissue retention of (⁷⁵SeO₃)-2 in the rat. *J Nutr* 102:1049-1055.
- *Burk RT, Hill K, Motley AK. 2001. Plasma selenium in specific and non specific forms. *Biofactors* 14:107-114.
- Burke KE. 1992. L-selenomethionine on pigmentation and skin damage. *Cosmetics & Toiletries* 107 (Jul):51-52, 54-58, 60-61.
- *Burke KE, Burford RG, Combs Jr. GF, et al. 1992a. The effect of topical L-selenomethionine on minimal erythema dose of ultraviolet irradiation in humans. *Photodermatol Photoimmunol Photomed* 9(2):52-57.
- *Burke KE, Combs Jr. GF, Gross EG, et al. 1992b. The effects of topical and oral L-selenomethionine on pigmentation and skin cancer induced by ultraviolet irradiation. *Nutr Cancer* 17(2):123-137.
- Butler JA, Beilstein MA, Whanger PD. 1989. Influence of dietary methionine on the metabolism of selenomethionine in rats. *J Nutr* 119:1001-1009.

9. REFERENCES

- *Butler JA, Whanger PD, Kaneps AJ, et al. 1990. Metabolism of selenite and selenomethionine in the rhesus monkey. *J Nutr* 120(7):751-759.
- *Byard JL. 1969. Trimethyl selenide. A urinary metabolite of selenite. *Arch Biochem Biophys* 130:556-560.
- *Cahill TM, Anderson DW, Elbert RA, et al. 1998. Elemental profiles in feather samples from a mercury-contaminated lake in central California. *Arch Environ Contam Toxicol* 35:75-81.
- Calomme M, Vanderpas J, Francois B, et al. 1995. Effects of selenium supplementation on thyroid hormone metabolism in phenylketonuria subjects on a phenylalanine restricted diet. *Biol Trace Elem Res* 47:349-353.
- Campbell MB, Kanert GA. 1992. High-pressure microwave digestion for the determination of arsenic, antimony, selenium and mercury in oily wastes. *Analyst* 117(2):121-124.
- Cann SA, van Netten JP, van Netten C. 2000. Hypothesis: Iodine, selenium and the development of breast cancer. *Cancer Causes Control* 11:121-127.
- *Cantor AH, Langerin ML, Noguchi T, et al. 1975. Efficacy of selenium in selenium compounds and feedstuffs for prevention of pancreatic fibrosis in chicks. *J Nutr* 105:106-111.
- Cao ZH, Wang XC, Yao DH, et al. 2001. Selenium geochemistry of paddy-soils in Yangtze River Delta. *Env Int* 26(5-6):335-339.
- Capar SG, Cunningham WC. 2000. Element and radionuclide concentrations in food: FDA total diet study 1991-1996. *J AOAC Int* 83(1):157-177.
- *Capon CJ. 1981. Mercury and selenium content and chemical form in vegetable crops grown on sludge amended soil. *Arch Environ Contam Toxicol* 10:673-690.
- Capon CJ. 1991. Sewage sludge as a source of environmental selenium. *Sci Total Environ* 100(SpecNo):177-205.
- Caravaggi C, Clark FL, Jackson ARB. 1970a. Acute selenium toxicity in lambs following intramuscular injection of sodium selenite. *Res Vet Sci* 11:146-149.
- Caravaggi C, Clark FL, Jackson ARB. 1970b. Experimental acute toxicity of orally administered sodium selenite in lambs. *Res Vet Sci* 11:501-502.
- Cardellicchio N, Decataldo A, Di La Misino A. 2002. Accumulation and tissue distribution of mercury and selenium in striped dolphins (*Stenella coeruleoalba*) from the Mediterranean Sea (Southern Italy). *Environ Pollut* 116(2):265-271.
- Carlo PL, Owens LP, Hanna Jr. GP, et al. 1992. The removal of selenium from water by slow sand filtration. *Proceedings of the Sixteenth Biennial Conference of the International Association of Water Pollution Research and Control. Water Sci Technol* 26(1-11):2137-2140.
- *Carter RF. 1966. Acute selenium poisoning. *Med J Aust* 1:525-528.

9. REFERENCES

- *Casey CE, Guthrie BE, McKenzie JM. 1983. Dunedin, New Zealand, personal communication. (As cited in Iyengar 1987).
- *Cavalieri RR, Scott KG, Sairenji E. 1966. Selenite (^{75}Se) as a tumor-localizing agent in man. *J Nucl Med* 7:197-208.
- CELDS. 1993. Corps of Engineers Construction Engineering Research Laboratory and University of Illinois, Department of Urban and Regional Planning. Computer-aided environmental legislative data systems [Database].
- Cenac A, Simonoff M, Moretto P, et al. 1992. A low plasma selenium is a risk factor for peripartum cardiomyopathy. A comparative study in Sahelian Africa. *Int J Cardiol* 36(1):57-59.
- Cenedella RJ. 1989. Cell cycle specific effects of selenium on the lens epithelium studied *in vivo* by the direct chemical approach. *Curr Eye Res* 8(4):429-433.
- *Černá M, Spěváčková V, Čejchanová M, et al. 1997. Population-based biomonitoring in the Czech Republic-the system and selected results. *Sci Total Environ* 204:263-270.
- Chakraborty S, Ghosh R, Chatterjee M. 1995. Relation between human selenium levels and epidemiology of cancer in different districts of West Bengal, India [Abstract]. *Anticancer Res* 15(5A):1651-1652.
- Chan CC, Sadana RS. 1992. Determination of arsenic and selenium in environmental samples by flow-injection hydride generation atomic absorption spectrometry. *Anal Chim Acta* 270(1):231-238.
- *Chang LW. 1983. Protective effects of selenium against methylmercury neurotoxicity: A morphological and biochemical study. *Exp Pathol* 23:143-156.
- Chang PWG, Tsui SKW, Liew C, et al. 1997. Isolation, characterization, and chromosomal mapping of a novel cDNA clone encoding human selenium binding protein. *J Cell Biochem* 64:217-224.
- Chapman PM. 1999. Invited debate/commentary: Selenium - A potential time bomb or just another contaminant? *Hum Ecol Risk Assess* 5(6):1123-1138.
- Chatt A, Holzbecher J, Katz SA. 1990. Metabolic deposition of selenium and cadmium into the hair and other tissues of the guinea pig. *Biol Trace Elem Res* 26-27:513-519.
- *Chaudiere J, Courtin O, Leclaire J. 1992. Glutathione oxidase activity of selenocystamine: A mechanistic study. *Arch Biochem Biophys* 296(1):328-336.
- *Chau YK, Riley JP. 1965. The determination of selenium in sea water, silicates and marine organisms. *Anal Chim Acta* 33:36-49.
- *Chau YK, Wong PTS, Silverberg BA, et al. 1976. Methylation of selenium in the aquatic environment. *Science* 192:1130-1131.
- *ChemIDplus. 2003. Division of Specialized Information Services, NLM. <http://chem.sis.nlm.nih.gov/chemidplus/cmplxqry.html>.

9. REFERENCES

Chen CL, Whanger PD. 1993. Effect of vitamin B12 status on selenium methylation and toxicity in rats: *In vivo* and *in vitro* studies. *Toxicol Appl Pharmacol* 118(1):65-72.

*Chen C, Hedstrom O, Whanger PD. 1993. Effect of vitamin B₁₂ on performance and tissue selenium content in rats fed sub-toxic levels of selenite. *Toxicology* 85:101-115.

*Chen M, Ma LQ, Harris WG. 1999. Baseline concentrations of 15 trace elements in Florida surface soils. *J Environ Qual* 28:1173-1181.

*Chen RW, Whanger PD, Weswig PH. 1975. Selenium-induced redistribution of cadmium binding to tissue proteins: A possible mechanism of protection against cadmium toxicity. *Bioinorg Chem* 4:125-133.

*Chen SY, Collipp PJ, Boasi LH, et al. 1982. Fluorometry of selenium in human hair, urine, and blood. A single-tube process for submicrogram determination of selenium. *Ann Nutr Metab* 26:186-190.

*Chen X, Mikhail SS, Ding YW, et al. 2000. Effects of vitamin E and selenium supplementation on esophageal adenocarcinogenesis in a surgical model with rats. *Carcinogenesis* 21(8):1531-1536.

*Chen XS, Yang GQ, Chen JS, et al. 1980. Studies on the relations of selenium and Keshan disease. *Biol Trace Elem Res* 2:91-107.

Cheng W-H, Ho Y-S, Valentine BA, et al. 1998. Cellular glutathione peroxidase is the mediator of body selenium to protect against paraquat lethality in transgenic mice. *J Nutr* 128:1070-1076.

*Chhabra SK, Rao AR. 1994. Translactational exposure of F₁ mouse pups to selenium. *Food Chem Toxicol* 32(6):527-531.

*Chiachun T, Hong C, Haifun R. 1991. The effects of selenium on gestation, fertility, and offspring in mice. *Biol Trace Elem Res* 30(3):227-231.

Chidambaram N, Baradarajan A. 1996. Influence of selenium on glutathione and some associated enzymes in rats with mammary tumor induced by 7,12-Dimethylbenz(a)anthracene. *Mol Cell Biochem* 156:101-107.

Chmielnicka J, Hajdukiewica Z, Komstra-Szumaska E, et al. 1978. Whole-body retention of mercury and selenium and histopathological and morphological studies of kidneys and liver of rats exposed repeatedly to mercuric chloride and sodium selenite. *Arch Toxicol* 40:189-199.

Chou C, Holler J, De Rosa CT. 1998. Minimal risk levels (MRLs) for hazardous substances. *J Clean Technol Environ Toxicol Occup Med* 7(1):1-24.

Chowdhury AR. 1996. A short review on chemically induced injury to the testicular tissue. *Indian J Physiol Allied Sci* 50(3):136-144.

*Chowdhury AR, Venkatakrishna-Bhatt H. 1983. Effect of selenium dioxide on the testes of rat. *Indian J Physiol Pharmacol* 27:237-240.

*Choy WN, Henika PR, Willhite CC, et al. 1993. Incorporation of a micronucleus study into a developmental toxicology and pharmacokinetic study of L-selenomethionine in nonhuman primates. *Environ Mol Mutagen* 21(1):73-80.

9. REFERENCES

- *Choy WN, Willhite CC, Cukierski MJ, et al. 1989. Primate micronucleus study of L-selenomethionine. *Environ Mol Mutagen* 14(2):123-125.
- Ciappellano S, Testolin G, Allegrini M, et al. 1990. Availability of selenium in dough and biscuit in comparison to wheat meal. *Ann Nutr Metab* 34(6):343-349.
- Ciappellano S, Testolin G, Porrini M. 1989. Effects of durum wheat dietary selenium on glutathione peroxidase activity and Se content in long-term-fed rats. *Ann Nutr Metab* 33(1):22-30.
- Cikrt M, Mravcova A, Malatova I, et al. 1988. Distribution and excretion of ⁷⁴As and ⁷⁵Se in rats after their simultaneous administration: The effect of arsenic, selenium and combined pretreatment. *J Hyg Epidemiol Microbiol Immunol* 32(1):17-29.
- *Civil IES, McDonald MJA. 1978. Acute selenium poisoning: Case report. *N Z Med J* 87:354-356.
- Clark DR. 1987. Selenium accumulation in mammals exposed to contaminated California irrigation drainwater. *Sci Total Environ* 66:147-168.
- Clark LC. 1985. The epidemiology of selenium and cancer. *Federation Proceedings* 44:2584-2589.
- Clark LC, Jacobs ET. 1998. Environmental selenium and cancer: Risk or protection? *Cancer Epidemiol Biomarkers Prev* 7:847-848.
- *Clark LC, Combs GF, Turnbull BW, et al. 1996a. Effects of selenium supplementation for cancer prevention in patients with carcinoma of the skin. *JAMA* 276(24):1957-1963.
- *Clark LC, Dalkin B, Krongrad A, et al. 1999. Decreased incidence of prostate cancer with selenium supplementation: Results of a double-blind cancer prevention trial. *J Am Nutraceut Assoc* 2(1):14-18.
- *Clark LC, Graham GF, Crounse RG, et al. 1984. Plasma selenium and skin neoplasms: A case-control study. *Nutr Cancer* 6:12-21.
- *Clark RF, Strukle E, Williams SR, et al. 1996b. Selenium poisoning from a nutritional supplement. *JAMA* 275(14):1087-1088.
- Clarkson PM. 1991. Minerals: Exercise performance and supplementation in athletes. *J Sports Sci* 9(SpecNo):91-116.
- Clausen J. 1991. Uptake and distribution in rat brain of organic and inorganic selenium. *Biol Trace Elem Res* 28(1):39-45.
- Clausen J, Nielsen SA. 1988. Comparison of whole blood selenium values and erythrocyte glutathione peroxidase activities of normal individuals on supplementation with selenate, selenite, L-selenomethionine, and high selenium yeast. *Biol Trace Elem Res* 15:125-138.
- *Clausen J, Nielsen SA, Kristensen M. 1989. Biochemical and clinical effects of an antioxidative supplementation of geriatric patients. A double blind study. *Biol Trace Elem Res* 20(1-2):135-151.
- *Clewell HJ III, Andersen ME. 1985. Risk assessment extrapolations and physiological modeling. *Toxicol Ind Health* 1(4):111-131.

9. REFERENCES

- *Clinton M Jr. 1947. Selenium fume exposure. *J Indust Hyg Toxicol* 29:225-226.
- *Clinton OE. 1977. Determination of selenium in blood and plant material by hydride generation and atomic absorption spectroscopy. *Analyst* 102:187-192.
- *Coates RJ, Weiss NS, Daling JR, et al. 1988. Serum levels of selenium and retinol and the subsequent risk of cancer. *Am J Epidemiol* 128:515-523.
- Cohen HJ, Avissar N. 1993. Molecular and biochemical aspects of selenium metabolism and deficiency. *Prog Clin Biol Res* 380:191-202.
- Colditz GA. 1996. Selenium and cancer prevention: Promising results indicate further trials required. *JAMA* 276(24):1984-1985.
- *Coleman RA, Delevaux M. 1957. Occurrence of selenium in sulfides from some sedimentary rocks of western United States. *Econ Geol* 52:499-527.
- Combs GF. 1988. Selenium in foods. *Adv Food Res* 32:85-113.
- Combs GF. 1993. Essentiality and toxicity of selenium with respect to recommended daily allowances and reference doses. *Scand J Work Environ Health* 19(suppl 1):119-121.
- Combs GF. 1997. Dietary selenium allowances and new threshold intakes with respect to toxicity. *Biomed Environ Sci* 10:356-358.
- Combs GF. 1999. Chemopreventive mechanisms of selenium. *Med Klin* 94(Suppl. 3):18-24.
- Combs GF. 2001. Impact of selenium and cancer-prevention findings on the nutrition-health paradigm. *Nutr Cancer* 40(1):6-11.
- Combs GF, Gray WP. 1998. Chemopreventive agents: Selenium. *Pharmacol Ther* 79(3):179-192.
- Combs GF, Clark LC, Turnbull BW. 1998. Evidence of cancer prevention by selenium in a randomized, placebo-controlled, clinical trial. In: Collery P, Brätter PN de B V, Negretti de Brätter V, et al., eds. *Metal ions in biology and medicine*. Paris, France: John Libbey Eurotext, 566-571.
- *Combs JGF, Combs SB. 1987. Selenium effect on drug and foreign compound toxicity. *Pharmacol Ther* 33:303-315.
- *Contempre B, Deneff JF, Dumont JE, et al. 1993. Selenium deficiency aggravates the necrotizing effects of a high iodide dose in iodine deficient rats. *Endocrinology* 132(4):1866-1868.
- *Contempré B, Duale NL, Dumont JE, et al. 1992. Effect of selenium supplementation on thyroid hormone metabolism in an iodine and selenium deficient population. *Clin Endocrinol* 36:579-583.
- *Contempré B, Dumont JE, Deneff J-F. 1995. Effects of selenium deficiency on thyroid necrosis, fibrosis and proliferation: A possible role in myxoedematous cretinism. *Euro J Epidemiol* 133:99-109.

9. REFERENCES

- *Contempré B, Dumont JE, Ngo B, et al. 1991a. Effect of selenium supplementation in hypothyroid subjects of an iodine and selenium deficient area: The possible danger of indiscriminate supplementation of iodine-deficient subjects with selenium. *J Clin Endocrinol Metab* 73(1):213-215.
- *Contempré B, Vanderpas J, Dumont JE. 1991b. At the cutting edge. Cretinism, thyroid hormones and selenium. *Mol Cell Endocrinol* 81(1-3):C193-195.
- Coquery M, Carvalho FP, Azemard S, et al. 1999. The IAEA worldwide intercomparison exercises (1990-1997): Determination of trace elements in marine sediments and biological samples. *Sci Total Environ* 237-238(0):501-508.
- *Corden FL, Alexiou NG, Martin DF. 1989. Blood selenium in select mid-income Florida employees. *J Environ Sci Health A24(5):535-542.*
- Corrigan FM, Besson JA, Ward NI. 1991. Red cell caesium, lithium and selenium in abstinent alcoholics. *Alcohol* 26(3):309-314.
- *Cortez E. 1984. Santiago, Chile, personal communication. (As cited in Iyengar 1987).
- Corvilain B, Contempre B, Longombe AO, et al. 1993. Selenium and the thyroid: How the relationship was established. *Am J Clin Nutr* 57(2 Suppl):244S-248S.
- Costello A. 2001. A randomized, controlled chemopreventative trial of selenium in familial prostate cancer: Rationale, recruitment, and design. *Urology* 57:182-184.
- Crespo AM, Neve J, Pinto RE. 1993. Plasma and liver selenium levels in the rat during supplementation with 0.5, 2, 6, and 15 ppm selenium in drinking water. *Biol Trace Elem Res* 38:139-146.
- *CRISP. 1995. Computer Retrieval of Information on Science Projects. Subfile of Toxline Database, National Library of Medicine, National Institutes of Health, Bethesda, MD.
- *CRISP. 1999. Computer Retrieval of Information on Science Projects. Subfile of Toxline Database Bethesda, MD: National Library of Medicine, National Institutes of Health.
- *CRISP. 2001. Computer Retrieval of Information on Science Projects. Subfile of Toxline Database Bethesda, MD: National Library of Medicine, National Institutes of Health.
- *CRISP. 2002. Computer Retrieval of Information on Science Projects. Subfile of Toxline Database Bethesda, MD: National Library of Medicine, National Institutes of Health.
- *CRIS/USDA. 1995. Current Research Information System. Washington DC: U.S. Department of Agriculture.
- *CRIS/USDA. 1999. Current Research Information System. Washington DC: U.S. Department of Agriculture.
- *CRIS/USDA. 2001. Current Research Information System. Washington DC: U.S. Department of Agriculture.
- *CRIS/USDA. 2002. Current Research Information System. Washington DC: U.S. Department of Agriculture.

9. REFERENCES

- *CRWQCB. 1988. Water and sediment quality in evaporation basins used for the disposal of agricultural subsurface drainage water in the San Joaquin Valley, California. Sacramento, CA: California Regional Water Quality Control Board.
- *Cukierski MJ, Willhite CC, Lasley BL, et al. 1989. 30-Day oral toxicity study of L-selenomethionine in female long-tailed macaques (*Macaca fascicularis*). *Fundam Appl Toxicol* 13(1):26-39.
- *Cummins LM, Kimura ET. 1971. Safety evaluation of selenium sulfide antidandruff shampoos. *Toxicol Appl Pharmacol* 20:89-96.
- *Cutter GA. 1982. Selenium in reducing waters. *Science* 217:829-831.
- *Cutter GA. 1989. The estuarine behavior of selenium in San Francisco Bay. *Estuarine, Coastal Shelf Sci* 28(1):13-34.
- *Daher R, Van Lente F. 1992. Characterization of selenocysteine lyase in human tissues and its relationship to tissue selenium concentrations. *J Trace Elem Electrolytes Health and Dis* 6:189-194.
- *Dams R, Robbins JA, Rhan KA, et al. 1970. Nondestructive neutron activation analysis of air pollution particulates. *Anal Chem* 42:861-867.
- *Damyanova A. 1983. Sofia, Bulgaria, personal communication. (As cited in Iyengar 1987).
- Daniels LA. 1996. Selenium metabolism and bioavailability. *Biol Trace Elem Res* 54:185-199.
- Danielsson BR, Danielson M, Khayat A, et al. 1990. Comparative embryotoxicity of selenite and selenate: Uptake in murine embryonal and fetal tissues and effects on blastocysts and embryonic cells *in vitro*. *Toxicology* 63(2):123-136.
- Darlow BA, Inder TE, Graham PJ, et al. 1995. The relationship of selenium status to respiratory outcome in the very low birth weight infant. *Pediatrics* 96:314-319.
- Das PM, Sadana JR, Gupta RK, et al. 1989a. Experimental selenium toxicity in guinea pigs: Biochemical studies. *Ann Nutr Metab* 33(1):57-63.
- *Das PM, Sadana JR, Gupta RK, et al. 1989b. Experimental selenium toxicity in guinea pigs: Haematological studies. *Ann Nutr Metab* 33(6):347-353.
- Datnow MM. 1928. An experimental investigation concerning toxic abortion produced by chemical agents. *J Obstet Gynaecol Br Emp* 35:693-724.
- *Davidson-York D, Galey FD, Blanchard P, et al. 1999. Selenium elimination in pigs after an outbreak of selenium toxicosis. *J Vet Diagn Invest* 11:352-357.
- Davis CD, Feng Y, Hein DW, et al. 1999. The chemical form of selenium influences 3,2'-Dimethyl-4-aminobiphenyl-DNA adduct formation in rat colon. *J Nutr* 129:63-69.
- *Dawson SW, Mercer BW. 1986. Hazardous waste management. New York, NY: John Wiley and Sons, 55.

9. REFERENCES

- Deagen JT, Beilstein MA, Whanger PD. 1990. Chemical forms of selenium in selenium containing proteins from human plasma. *J Inorg Biochem* 41(4):261-268.
- Deagan JT, Butler JA, Beilstein MA, et al. 1987. Effects of dietary selenite, selenocystine and selenomethionine on selenocysteine lyase and glutathione peroxidase activities and on selenium levels in rat tissues. *J Nutr* 117:91-98.
- Deagen JT, Butler JA, Zachara BA, et al. 1993. Determination of the distribution of selenium between glutathione peroxidase, selenoprotein P, and albumin in plasma. *Anal Biochem* 208(1):176-181.
- *Deguchi Y. 1985. Relationships between blood selenium concentrations and grasping power, blood pressure, hematocrit, and hemoglobin concentrations in Japanese rural residents. *Japanese Journal of Hygiene* 39:924-929.
- Del Debbio JA. 1991. Sorption of strontium, selenium, and mercury in soil. *Radiochimica Acta* 52-53(pt1):181-186.
- Del Debbio JA, Thomas TR. 1991. Determination of technetium and selenium transport properties in laboratory soil columns. *Mater Res Soc Symp Proc VOL 127. ISS Sci Basis Nucl Waste Manage* 12:957-964.
- *Delange F, Lecomte P. 2000. Iodine supplementation. Benefits outweigh risks. *Drug Saf* 22(2):89-95.
- de Oliveira E, McLaren JW, Berman SS. 1983. Simultaneous determination of arsenic, antimony, and selenium in marine samples by inductively coupled plasma atomic emission spectrometry. *Anal Chem* 55:2047-2050.
- Deshchekina MF, Demin VF, Kliuchnikov SO, et al. 1989. Contents of bioelements in blood of newborn infants with a history of chronic intrauterine hypoxia. *Pediatrics* (10):19-24.
- Devamanoharan PS, Henein M, Morris S, et al. 1991. Prevention of selenite cataract by vitamin C. *Exp Eye Res* 52(5):563-568.
- Deverel SJ, Fio JL. 1991. Groundwater flow and solute movement to drain laterals, western San Joaquin Valley, California. *Water Resources Research* 27(9):2233-2246.
- Deverel SJ, Millard SP. 1988. Distribution and mobility of selenium and other trace elements in shallow groundwater of the western San Joaquin Valley, California. *Environ Sci Technol* 22:697-702.
- Deverel SJ, Fio JL, Dubrovsky NM. 1994. Distribution and mobility of selenium in groundwater in the western San Joaquin Valley of California. In: Frankenberger WT, Benson S, eds. *Selenium Environment*. New York, NY: Dekker, 157-183.
- DeYoung DJ, Bantle JA, Fort DJ. 1991. Assessment of the developmental toxicity of ascorbic acid, sodium selenate, coumarin, serotonin, and 13-*cis* retinoic acid using FETAX. *Drug Chem Toxicol* 14(1-2):127-141.
- *DHHS. 1997. National Health and Nutrition Examination Survey (NHANES), III 1988-1994. CD-ROM Series 11, No. 1. (July 1997). U.S. Department of Health and Human Services, Public Health Service, Centers for Disease Control and Prevention (CDC).

9. REFERENCES

- *DHHS. 2002. Dietary intake of macronutrients, micronutrients, and other dietary constituents: United States, 1988-94. Data from the National Health Examination Survey, the National Health and Nutrition Examination Surveys, and the Hispanic Health and Nutrition Examination Survey. Haysville, Maryland: Department of Health and Human Services.
- Dhur A, Galan P, Hercberg S. 1990. Relationship between selenium, immunity and resistance against infection. *Comp Biochem Physiol [C]* 96(2):271-280.
- Diamond AM, Dale P, Murray JL, et al. 1996. The inhibition of radiation-induced mutagenesis by the combined effects of selenium and the aminothiols WR-1065. *Mutat Res* 356:146-154.
- Dias MF, Sousa E, Cabrita S, et al. 2000. Chemoprevention of DMBA-induced mammary tumors in rats by a combined regimen of alpha-tocopherol, selenium, and ascorbic acid. *Breast J* 6(1):14-19.
- Dietz R, Riget F, Born EW. 2000. An assessment of selenium to mercury in Greenland marine animals. *Sci Total Environ* 245:15-24.
- Di Ilio C, Del Bocceo G, Casaccia R, et al. 1987. Selenium level and glutathione-dependent enzyme activities in normal and neoplastic human lung tissues. *Carcinogenesis* 8:281-284.
- *Dickson RC, Tomlinson RH. 1967. Selenium in blood and human tissues. *Clinica Chimica Acta* 16:311-321.
- *Dilworth GL, Bandurski RS. 1977. Activation of selenate by adenosine 5'-triphosphate sulphurylase from *Saccharomyces cerevisiae*. *Biochem J* 163:521-529.
- *Dimes L, Rendig VV, Besgu G, et al. 1988. Selenium uptake by subclover, ryegrass, and some *Astragalus* spp. In: Tanji KK, Valoppi L, Woodring RC, eds. Selenium contents in animal and human food crops grown in California. CA: Cooperative Extension University of California, Division of Agriculture and Natural Resources. Publication 3330, 19-24.
- *Dini G, Franconi F, Martini F. 1981. Mitochondrial alterations induced by selenium in guinea pig myocardium. *Exp Mol Pathol* 34:226-235.
- *Dinkel CA, Minyard JA, Ray DE. 1963. Effects of season of breeding on reproductive and weaning performance of beef cattle grazing on seleniferous range. *J Anim Sci* 22:1043-1045.
- Diplock AT. 1993. Indexes of selenium status in human populations. *Am J Clin Nutr* 57(2 Suppl):256S-258S.
- *Diplock AT, Green J, Bunyan J, et al. 1967. Vitamin E and stress. 3. The metabolism of D-alpha-tocopherol in the rat under dietary stress with silver. *Br J Nutr* 21:115-125.
- *DOE. 1987. A cathodic stripping technique for the determination of trace levels of arsenic and selenium in waste, organic, and environmental samples. Report to U.S. Department of Energy by Martin Marietta Energy Systems, Inc., Oak Ridge, TN. DOE K/PS-5078. DE88-002257.
- DOE. 1993. Selenium in Oklahoma ground water and soil. Quarterly report No. 6 to the U.S. Department of Energy. DOE/PC/89782--T6. DE92-018300.

9. REFERENCES

- DOE. 1996. Mercury-selenium interactions in the environment. Upton, NY: U.S. Department of Energy, Office of Fossil Energy. NTIS DE 96 006 148.
- *Donaldson WE, McGowan C. 1989. Lead toxicity in chickens. Interaction with toxic dietary levels of selenium. *Biol Trace Elem Res* 20(1-2):127-133.
- *Doran JW. 1982. Microorganisms and the biological cycling of selenium. *Adv Microbiol Ecol* 6:1-32.
- *Doran, JW, Alexander M. 1976. Microbial formation of volatile selenium compounds in soil. *Soil Science Society of America Journal* 40:687-690.
- Downs TJ, Cifuentes-García E, Suffet IM. 1999. Risk screening for exposure to groundwater pollution in a wastewater irrigation district of the Mexico City region. *Environ Health Perspect* 107(7):553-561.
- *Draize JH, Beath OA. 1935. Observations on the pathology of blind staggers and alkali disease. *J Am Vet Med Assoc* 86:753-763.
- *Dreher GB, Finkelman RB. 1992. Selenium mobilization in a surface coal mine, Powder River Basin, Wyoming, USA. *Environ Geol Water Sci* 19(3):155-169.
- Duckart EC, Waldron LJ, Donner HE. 1992. Selenium uptake and volatilization from plants growing in soil. *Soil Science* 153(2):94-99.
- Ducros V, Favier A. 1992. Gas chromatographic-mass spectrometric method for the determination of selenium in biological samples. *J Chromatogr B: Biomed Appl* 583(1):35-44.
- *Ducros V, Laporte F, Belin N, et al. 2000. Selenium determination in human plasma lipoprotein fractions by mass spectrometry analysis. *J Inorg Biochem* 81:105-109.
- *Dudley HC. 1938. Toxicology of selenium. V. Toxic and vesicant properties of selenium oxychloride. *Public Health Rep* 53:94-98.
- *Dudley HC, Miller JW. 1937. Toxicology of selenium. IV. Effects of exposure to hydrogen selenide. *Public Health Rep* 52:1217-1231.
- *Dudley HC, Miller JW. 1941. Toxicology of selenium. VI. Effects of subacute exposure to hydrogen selenide. *Journal of Industrial Hygiene and Toxicology* 23:470-477.
- *Duffield AJ, Thomson CD, Hill KE, et al. 1999. An estimation of selenium requirements for New Zealanders. *Am J Clin Nutr* 70:896-903.
- *Duffield-Lillico et al. 2002. Baseline characteristics and the effect of selenium supplementation on cancer incidence in a randomized clinical trial: a summary report of the Nutritional Prevention of Cancer Trial. *Cancer Epidemiol Biomarkers Prev* 11(7):630-639.
- *Dulka JJ, Risby TH. 1976. Ultratrace metals in some environmental and biological systems. *Anal Chem* 48:640A-653A.
- Dutkiewicz VA, Husain L. 1988. Spatial pattern on non-urban selenium concentrations in the northeastern USA and its pollution source implications. *Atmos Environ* 22(10):2223-2228.

9. REFERENCES

- *Dworkin BM, Rosenthal WS, Wormser GP, et al. 1986. Selenium deficiency in the acquired immunodeficiency syndrome. *JPEN* 10:405-407.
- Dybing E, Sanner T, Roelfzema H, et al. 1997. T25: A simplified carcinogenic potency index: Description of the system and study of correlations between carcinogenic potency and species/site specificity and mutagenicity. *Pharmacol Toxicol* 80:272-279.
- Dyer SD, White-Hull CE, Shephard BK. 2000. Assessments of chemical mixtures via toxicity reference values overpredict hazard to Ohio fish communities. *Environ Sci Technol* 34:2518-2524.
- Early JL, Schnell RC. 1982. Effect of glutathione depletion on selenium lethality and hepatic drug metabolism in male rats. *Toxicol Lett* 11:253-257.
- Early II JL, Nonavinakere VK, Weaver A. 1992. Effect of cadmium and/or selenium on liver mitochondria and rough endoplasmic reticulum in the rat. *Toxicol Lett* 62(1):73-83.
- Eckhert CD, Lockwood MK, Shen B. 1993. Influence of selenium on the microvasculature of the retina. *Microvasc Res* 45(1):74-82.
- *Eder K, Kralik A, Kirchgebner M. 1995. [Influence of deficient to subtoxic selenium intake on metabolism of thyroid hormones]. *Z Ernahrungswiss* 34:277-283. (German)
- *Edwards WC, Blackburn TA. 1986. Selenium determination by Zeeman atomic absorption spectrophotometry. *Vet Hum Toxicol* 28:12-13.
- *Eisenmann CJ, Miller RK. 1994. The placental transfer and toxicity of selenite relative to cadmium in the human term perfused placenta. *Placenta* 15:883-985.
- Eisenmann CJ, Miller RK. 1995. The effect of selenium compounds (selenite, selenate, ebselen) on the production of thromboxane and prostacyclin by the human term placenta *in vitro*. *Toxicol Appl Pharmacol* 135:18-24.
- Ejima A, Watanabe C, Koyama H, et al. 1996. Determination of selenium in the human brain by graphite furnace atomic absorption spectrometry. *Biol Trace Elem Res* 54:9-21.
- *El-Bayoumy K. 1991. The role of selenium in cancer prevention. In: DeVita J, Hellman S, Rosenberg SA, eds. *Cancer Prevention*. Philadelphia, PA: J.B. Lippincott Company, 1-15.
- *El-Bayoumy K. 1997. Organoselenium compounds: A novel class of cancer chemopreventive agents. *Drugs Future* 22(5):539-545.
- *El-Bayoumy K. 2001. The protective role of selenium on genetic damage and on cancer. *Mutat Res* 475:123-139.
- *El-Bayoumy K, Upadhyaya P, Chae Y-H, et al. 1995. Chemoprevention of cancer by organoselenium compounds. *J Cell Biochem Suppl* 22:92-100.
- El-Bayoumy K, Upadhyaya P, Sohn O-S, et al. 1998. Synthesis and excretion profile of 1,4-^[14C]phenylenebis(methylene)selenocyanate in the rat. *Carcinogenesis* 19(9):1603-1607.

9. REFERENCES

- *Ellingsen DG, Nordhagen HP, Thomassen Y. 1995. Urinary selenium excretion in workers with low exposure to mercury vapour. *J Appl Toxicol* 15(1):33-36.
- Ellingsen DG, Thomassen Y, Aaseth J, et al. 1997. Cadmium and selenium in blood and urine related to smoking habits and previous exposure to mercury vapour. *J Appl Toxicol* 17(5):337-343.
- *Ellis L, Piccano MF, Smith AM, et al. 1990. The impact of gestational length on human milk selenium concentration and glutathione peroxidase activity. *Pediatr Res* 27:32-35.
- *El-Zarkouny SA, Ayoub MA, Ishak MHG, et al. 1999. Effect of carbosulfan pesticide and selenium on some semen characteristics and serum testosterone in male rabbits. *Int J Environ Health Res* 9:117-124.
- Emsley CL, Gao S, Li Y, et al. 2000. Trace element levels in drinking water and cognitive function among elderly Chinese. *Am J Epidemiol* 151(9):913-920.
- EPA. 1972. National inventory of sources and emissions. Boron, copper, selenium, and zinc. Section IV. Selenium. U.S. Environmental Protection Agency, Office of Air Programs. NTIS PB 219679.
- *EPA. 1974. Development of predictions of future pollution problems. Washington, DC: U.S. Environmental Protection Agency. EPA600/5-74-005.
- EPA. 1975. U.S. Environmental Protection Agency. Code of Federal Regulations. 40 CFR 141.
- *EPA. 1979a. Methods for chemical analysis of water and wastes. 1978. Methods 270.2 and 270.3 for selenium. Cincinnati, OH: U.S. Environmental Protection Agency, Environmental Monitoring and Support Laboratory. EPA 600/4-79-020.
- EPA. 1979b. U.S. Environmental Protection Agency. Code of Federal Regulations. 40 CFR 125.
- *EPA. 1979c. Water-related environmental fate of 129 priority pollutants. Washington, DC: U.S. Environmental Protection Agency, Office of Water Planning and Standards. EPA 440/4-29-029.
- *EPA. 1980a. U.S. Environmental Protection Agency. Code of Federal Regulations. 40 CFR 261.33(e).
- *EPA. 1980b. U.S. Environmental Protection Agency. Code of Federal Regulations. 40 CFR 261.33(f).
- EPA. 1980c. U.S. Environmental Protection Agency. Code of Federal Regulations. 40 CFR 261 Appendix VIII.
- EPA. 1980d. U.S. Environmental Protection Agency. Code of Federal Regulations. 40 CFR 261.24.
- EPA. 1980e. Ambient water quality criteria for selenium. Washington, DC: U.S. Environmental Protection Agency, Office of Water Regulations and Standards, Criteria and Standards Division. EPA 400/5-80-070.
- EPA. 1980f. U.S. Environmental Protection Agency. Federal Register 45:79347-79357.
- EPA. 1980g. U.S. Environmental Protection Agency. Code of Federal Regulations. 40 CFR 125.

9. REFERENCES

- EPA. 1982. Compilation of and commentary on existing methodologies and guidelines relating to "Risk assessments for complex mixtures." Cincinnati, OH: U.S. Environmental Protection Agency, Environmental Criteria and Assessment Office. Document number SRC TR-82-544., VIII-7.
- *EPA. 1983. U.S. Environmental Protection Agency. Code of Federal Regulations. 40 CFR 122.28.
- *EPA. 1984a. Health effects assessment for selenium. Cincinnati, OH: U.S. Environmental Protection Agency, Environmental Criteria and Assessment Office. EPA 540/1-86-058.
- *EPA. 1984b. Contract Laboratory Program Statement of Work. Inorganic analysis, multi-media, multi-concentration. U.S. Environmental Protection Agency, Contract Laboratory Program. SOW No. 784.
- *EPA 1984c. Occurrence of selenium in drinking water, food, and air. McLean, VA: U.S. Environmental Protection Agency, Office of Drinking Water.
- EPA. 1985a. Drinking water criteria document for selenium (Final draft). Cleveland, OH: U.S. Environmental Protection Agency, Office of Drinking Water. NTIS Publication No. PB86-118098.
- EPA. 1985b. U.S. Environmental Protection Agency. Federal Register 50:46936-47025.
- *EPA. 1985c. U.S. Environmental Protection Agency. Code of Federal Regulations. 40 CFR 302.4.
- EPA. 1985d. Speciation of selenium in groundwater. Cincinnati, OH: Environmental Protection Agency, Office of Research and Development. EPA 600/S2-84-190.
- EPA. 1986a. Health effects assessment for selenium (and compounds). Cincinnati, OH: U.S. Environmental Protection Agency, Office of Health and Environmental Assessment, Environmental Criteria and Assessment Office. EPA/540/1-86-058.
- EPA. 1986b. Verified reference doses (RfDs) of the U.S. EPA. ADI Work Group of the Risk Assessment Forum. U.S. Environmental Protection Agency. ECAO-CIN-475.
- *EPA. 1986c. Test methods for evaluating solid waste. Volume 1A. Laboratory manual physical/chemical methods. Washington, DC: U.S. Environmental Protection Agency, Office of Solid Waste and Emergency Response. SW-846 3rd Edition.
- EPA. 1986d. U.S. Environmental Protection Agency. Code of Federal Regulations. 40 CFR 403.
- EPA. 1986e. U.S. Environmental Protection Agency. Code of Federal Regulations. 40 CFR 302.4.
- EPA. 1986f. U.S. Environmental Protection Agency. Code of Federal Regulations. 40 CFR 710.
- EPA. 1987a. U.S. Environmental Protection Agency. Federal Register 52:21152-21208.
- EPA. 1987b. U.S. Environmental Protection Agency. Federal Register 52:8156.
- EPA. 1987c. U.S. Environmental Protection Agency. Code of Federal Regulations. 40 CFR 355, Appendix A.

9. REFERENCES

- EPA. 1987d. Reference dose (RfD): Description and use in health risk assessments. Volume I, Appendix A: Integrated risk information system supportive documentation. Washington, DC: U.S. Environmental Protection Agency, Office of Health and Environmental Assessment. EPA/600/8-86/032a.
- EPA. 1990a. Drinking water criteria document of selenium. Criteria and Standards Division, Office of Drinking Water (WH-550) U.S. Environmental Protection Agency. Washington, DC. PB 91-142828, TR-1242-65.
- *EPA. 1990b. Interim methods for development of inhalation reference concentrations. Washington, DC: U.S. Environmental Protection Agency, Office of Health and Environmental Assessment, Office of Research and Development, Environmental Criteria and Assessment Office. EPA 600/8-90/066A.
- EPA. 1991a. U.S. Environmental Protection Agency. Code of Federal Regulations. 40 CFR 141.
- EPA. 1991b. U.S. Environmental Protection Agency. Code of Federal Regulations. 40 CFR 261, Appendix VIII.
- EPA. 1991c. Standards for the management of specific hazardous wastes and specific types of hazardous waste management facilities. U.S. Environmental Protection Agency. Code of Federal Regulations. 40 CFR 266, Appendix IX.
- EPA. 1991d. Toxic chemical release reporting: community right-to-know. U.S. Environmental Protection Agency. Code of Federal Regulations. 40 CFR 372.
- EPA. 1991e. Ambient water quality criteria. Washington, DC: U.S. Environmental Protection Agency, Office of Science and Technology, Health and Ecological Criteria Division, Ecological Risk Assessment Branch, Human Risk Assessment Branch.
- EPA. 1992a. U.S. Environmental Protection Agency. Code of Federal Regulations. 40 CFR 117.
- EPA. 1992b. U.S. Environmental Protection Agency. Code of Federal Regulations. 40 CFR 141.
- EPA. 1992c. Hazardous materials table, special provisions, hazardous materials communications, emergency response information, and training requirements. U.S. Environmental Protection Agency. Code of Federal Regulations. 40 CFR 172.
- *EPA. 1993. Drinking Water Regulations and Health Advisories. U.S. Environmental Protection Agency, Office of Water, 9. May 1993.
- EPA. 1995a. U.S. Environmental Protection Agency. Washington, DC: Drinking water regulations and health advisories, Office of Water.
- EPA. 1995b. U.S. Environmental Protection Agency. Code of Federal Regulations. 40 CFR 122.28.
- EPA. 1995c. U.S. Environmental Protection Agency. Code of Federal Regulations. 40 CFR 125.
- EPA. 1995d. U.S. Environmental Protection Agency. Code of Federal Regulations. 40 CFR 116.4.
- EPA. 1995e. U.S. Environmental Protection Agency. Code of Federal Regulations. 40 CFR 117.3.

9. REFERENCES

- EPA. 1995f. U.S. Environmental Protection Agency. Code of Federal Regulations. 40 CFR 302.4.
- EPA. 1995g. U.S. Environmental Protection Agency. Code of Federal Regulations. 40 CFR 355 (Appendix A).
- EPA. 1995h. U.S. Environmental Protection Agency. Code of Federal Regulations. 40 CFR 261.33.
- EPA. 1995i. U.S. Environmental Protection Agency. Code of Federal Regulations. 40 CFR 261 (Appendix VII).
- EPA. 1995j. U.S. Environmental Protection Agency. Code of Federal Regulations. 40 CFR 261.24.
- *EPA. 1997a. Method 7741A: Selenium (Atomic absorption, gaseous hydride). In: Status tables for SW-846, third edition. U.S. Environmental Protection Agency.
- *EPA. 1997b. Method 7742: Selenium (Atomic absorption, borohydride reduction). In: Status tables for SW-846, third edition. U.S. Environmental Protection Agency.
- *EPA. 1997c. Special report on environmental endocrine disruption: An effects assessment and analysis. Washington, DC: U.S. Environmental Protection Agency, Risk Assessment Forum. EPA/630/R-96/012.
- *EPA. 2000. Drinking water standards and health advisories. U.S. Environmental Protection Agency, Office of Water. EPA 822-B-00-001.
- *EPA. 2001a. Concentration limits. U.S. Environmental Protection Agency. Code of Federal Regulations. 40 CFR 264.94. <http://esweb.bna.com>. February 22, 2001.
- *EPA. 2001b. Designation of hazardous substances. U.S. Environmental Protection Agency. Code of Federal Regulations. 40 CFR 116.4. <http://esweb.bna.com>. February 22, 2001.
- *EPA. 2001c. Determination of reportable quantities. U.S. Environmental Protection Agency. Code of Federal Regulations. 40 CFR 117.3. <http://esweb.bna.com>. February 22, 2001.
- *EPA. 2001d. Establishment of numeric criteria for priority toxic pollutants for the state of California. U.S. Environmental Protection Agency. Code of Federal Regulations. 40 CFR 131.38. <http://esweb.bna.com>. February 22, 2001.
- *EPA. 2001e. Ground-water monitoring list. U.S. Environmental Protection Agency. Code of Federal Regulations. 40 CFR 264, Appendix IX. <http://esweb.bna.com>. February 22, 2001.
- *EPA. 2001f. Hazardous constituents. U.S. Environmental Protection Agency. Code of Federal Regulations. 40 CFR 261, Appendix VIII. <http://esweb.bna.com>. February 22, 2001.
- *EPA. 2001g. Listed constituents. U.S. Environmental Protection Agency. Code of Federal Regulations. 40 CFR 192, Appendix I. <http://esweb.bna.com>. February 22, 2001.
- *EPA. 2001h. Maximum concentration of constituents for ground-water protection. U.S. Environmental Protection Agency. Code of Federal Regulations. 40 CFR 131.36, (Table 1). <http://esweb.bna.com>. February 22, 2001.

9. REFERENCES

- *EPA. 2001i. Maximum contaminant level goals for inorganic contaminants. U.S. Environmental Protection Agency. Code of Federal Regulations. 40 CFR 141.51. <http://esweb.bna.com>. February 22, 2001.
- *EPA.. 2001j. Maximum contaminant levels for inorganic contaminants. U.S. Environmental Protection Agency. Code of Federal Regulations. 40 CFR 141.62. <http://esweb.bna.com>. February 22, 2001.
- *EPA. 2001k. Pollutant limits. U.S. Environmental Protection Agency. Code of Federal Regulations. 40 CFR 503.13. <http://esweb.bna.com>. February 22, 2001.
- *EPA. 2001l. Selenious acid. U.S. Environmental Protection Agency. Code of Federal Regulations. 40 CFR 266, Appendix IV. <http://esweb.bna.com>. February 23, 2001.
- *EPA. 2001m. Selenium and compounds: Hazard summary. U.S. Environmental Protection Agency. <http://www.epa.gov/ttn/uatw/hlthef/selenium.html>. February 22, 2001.
- *EPA. 2001n. Sequential CAS registry number list of CERCLA hazardous substances. U.S. Environmental Protection Agency. Code of Federal Regulations. 40 CFR 302.4, Appendix A. <http://esweb.bna.com>. February 22, 2001.
- *EPA. 2001o. Specific toxic chemical listings. U.S. Environmental Protection Agency. Code of Federal Regulations. 40 CFR 372.65. <http://esweb.bna.com>. February 22, 2001.
- *EPA. 2001p. The list of extremely hazardous substances and their threshold planning quantities. U.S. Environmental Protection Agency. Code of Federal Regulations. 40 CFR 355, Appendix B. <http://esweb.bna.com>. February 22, 2001.
- *EPA. 2001q. Waste specific prohibitions - California list wastes. U.S. Environmental Protection Agency. Code of Federal Regulations. 40 CFR 148.12. <http://esweb.bna.com>. February 23, 2001.
- Erbas D, Soncul H, Türkozkcan N, et al. 1995. Effect of selenium on ischemic and reperfusion injury in isolated guinea pig lungs. *Gen Pharmacol* 26(8):1669-1672.
- Esterbauer H, Zollner H, Schaur RJ. 1989. Aldehydes formed by lipid peroxidation. Membrane lipid oxidation. Boca Raton, FL: CRC Press, 239-268.
- *Evans CS, Asher CJ, Johnson CM. 1968. Isolation of dimethyl diselenide and other volatile selenium compounds from *Astragalus racemosus* (Pursh.). *Aust J Biol Sci* 21:13-20.
- *Ewan RC, Pope AL, Baumann CA. 1967. Elimination of fixed selenium by the rat. *J Nutr* 91:547-554.
- *Eybl V, Koutenska M, Koutensky J, et al. 1992. Selenium-silver interaction in mice. *Arch Toxicol Suppl* 15:160-163.
- Fairey R, Taberski K, Lamerdin S, et al. 1997. Organochlorines and other environmental contaminants in muscle tissues of sportfish collected from San Francisco Bay. *Mar Pollut Bull* 34(12):1058-1071.
- Fan AM, Book SA, Neutra RR, et al. 1988. Selenium and human health implications in California's San Joaquin Valley. *J Toxicol Environ Health* 23(4):539-559.

9. REFERENCES

- Fant ML, Nyman M, Helle E, et al. 2000. Mercury, cadmium, lead and selenium in ringed seals. *Environ Pollut* 111(3):493-501.
- Fardy JJ, McOrist GD, Farrar YJ. 1989. The determination of selenium status in the Australian diet using neutron activation analysis. *Journal of Radioanalytical and Nuclear Chemistry* 133(2):397-405.
- *FDA. 1982a. FDA compliance program report of findings. FY 79 total diet studies--adult (7305.002). Washington, DC: U.S. Department of Health and Human Services, U.S. Food and Drug Administration. PB83-112722.
- FDA. 1982b. FDA compliance program report of findings. FY 79 total diet studies--infants and toddlers (7305.002). Washington, DC: U.S. Department of Health and Human Services, Food and Drug Administration. PB82-260213.
- *FDA. 1993. Food and Drugs. Washington, DC: U.S. Food and Drug Administration. 21 CFR 103-35.
- *FDA. 2000. Total diet study statistics on element results. Washington, DC: U.S. Food and Drug Administration.
- *FDA. 2001a. Food additives permitted in feed and drinking water of animals. U.S. Department of Health and Human Services, U.S. Food and Drug Administration. Code of Federal Regulations. 21 CFR 573.920. <http://www4.law.cornell.edu/cfr/21p165.htm>. March 19, 2001.
- *FDA. 2001b. Requirements for specific standardized beverages. U.S. Department of Health and Human Services, U.S. Food and Drug Administration. Code of Federal Regulations. 21 CFR 165.110. <http://www4.law.cornell.edu/cfr/21p165.htm>. March 19, 2001.
- FEDRIP. 1994. Federal Research in Progress [Database]. Dialog Information Retrieval System, CA.
- FEDRIP. 2001. Federal Research in Progress [Database]. Dialog Information Retrieval System, CA.
- *FEDRIP. 2002. Federal Research in Progress [Database]. Dialog Information Retrieval System, CA.
- *Ferm VH, Hanlon DP, Willhite CC, et al. 1990. Embryotoxicity and dose response relationships of selenium in hamsters. *Reprod Toxicol* 4(3):183-190.
- *Fernandez FJ, Giddings R. 1982. Elimination of spectral interference using Zeeman effect background correction. *Atomic Spectroscopy* 3:61-65.
- *Finley JW. 1998. The absorption and tissue distribution of selenium from high-selenium broccoli are different from selenium from sodium selenite, sodium selenate, and selenomethionine as determined in selenium-deficient rats. *J Agric Food Chem* 46:3702-3707.
- *Finley JW, Davis CD, Feng Y. 2000. Selenium from high selenium broccoli protects rats from colon cancer. *J Nutr* 130:2384-2389.
- Fio JL, Deverel SJ. 1991. Groundwater flow and solute movement to drain laterals, western San Joaquin Valley, California. 2. Quantitative hydrologic assessment. *Water Resources Research* 27(9):2247-2257.

9. REFERENCES

- *Fiorino JA, Jones JW, Capar SG. 1976. Sequential determination of arsenic, selenium, antimony and tellurium in foods via rapid hydride evolution and atomic absorption spectrometry. *Anal Chem* 48:120-125.
- *Fishbein L. 1983. Environmental selenium and its significance. *Fundam Appl Toxicol* 3:411-419.
- Fishbein L. 1986. Perspectives on selenium anticarcinogenicity. *Toxicol Environ Chem* 12:1-30.
- *Fitzhugh OG, Nelson AA, Bliss C. 1944. The chronic oral toxicity of selenium. *J Pharmacol Exp Ther* 80:289-299.
- *Flohe L, Wingender E, Brigelius-Flohe R. 1997. Regulation of glutathione peroxidases. In: Forman HJ, Cadenas E, eds. *Oxidative stress and signal transduction*. New York, NY: Chapman & Hall, 415-440.
- *Flora SJS, Behari JR, Asquin M, et al. 1982. Time depending protective effect of selenium against cadmium-induced nephrotoxicity and hepatotoxicity. *Chem Biol Interact* 42:345-351.
- Flynn A. 1992. Minerals and trace elements in milk. *Adv Food Nutr Res* 36:209-252.
- Foiles PG, Fujiki H, Suganuma M, et al. 1995. Inhibition of PKC and PKA by chemopreventive organoselenium compounds. *Int J Oncol* 7:685-690.
- Foster HD. 1993. The iodine-selenium connection: Its possible roles in intelligence, cretinism, sudden infant death syndrome, breast cancer and multiple sclerosis. *Med Hypotheses* 40(1):61-65.
- Foster HD. 1997. Landscapes of longevity: The calcium-selenium-mercury connection in cancer and heart disease. *Med Hypotheses* 48:355-360.
- Foster LH, Sumar S. 1997. Selenium in health and disease: A review. *Crit Rev Food Sci Nutr* 37(3):211-228.
- Franke KW, Potter VR. 1936. The effect of selenium containing foodstuffs on growth and reproduction of rats at various ages. *J Nutr* 12:205-214.
- *Franke KW, Tully WE. 1935. A new toxicant occurring naturally in certain samples of food stuffs. *Poult Sci* 14:273-279.
- *Franke K, Moxon AL, Poley WE, et al. 1936. Monstrosities produced by injection of selenium salt into hen's eggs. *Anat Rec* 65:15-22.
- Frenkel GD, Falvey D, MacVicar C. 1991. Products of the reaction of selenite with intracellular sulfhydryl compounds. *Biol Trace Elem Res* 30(1):9-18.
- *Frost DV. 1972. The two faces of selenium - Can selenophobia be cured? *CRC Crit Rev Toxicol* 1:467-514.
- Frost RR, Griffin RA. 1977. Effect of pH on adsorption of arsenic and selenium from landfill leachate by clay minerals. *Soil Science Society of America Journal* 41:53-57.

9. REFERENCES

- FSTRAC. 1990. Summary of state and federal drinking water standards and guidelines. Washington, DC: Chemical Communication Subcommittee Federal-State Toxicology and Regulatory Alliance Committee. U.S. Environmental Protection Agency.
- Fujii R, Deverel SJ, Hatfield DB. 1988. Distribution of selenium in soils of agricultural fields, western San Joaquin Valley California USA. *Soil Science Society of America Journal* 52(5):1274-1283.
- *Funk MA, Hamlin L, Picciano MF, et al. 1990. Milk selenium of rural African women: Influence of maternal nutrition, parity, and length of lactation. *Am J Clin Nutr* 51(2):220-224.
- *Furchner JE, London JE, Wilson JS. 1975. Comparative metabolism of radionuclides in mammals. IX. Retention of ⁷⁵Se in the mouse, rat, monkey and dog. *Health Phys* 29:641-648.
- Fürnsinn C, Englisch R, Ebner K, et al. 1996. Insulin-like vs. non-insulin-like stimulation of glucose metabolism by vanadium, tungsten, and selenium compounds in rat muscle. *Life Sci* 59(23):1989-2000.
- Furr AK, Parkinson TF, Bache CA, et al. 1980. Multielement absorption by crops grown on soils amended with municipal sludge ashes. *J Agric Food Chem* 28:660-662.
- Furuta N, Shinofuji T. 1996. Determination of different oxidation states of arsenic and selenium by inductively coupled plasma-atomic emission spectrometry with ion chromatography. *Fresenius J Anal Chem* 355(5-6):457-460.
- Gabrielsen BO, Opstvedt J. 1980. Availability of selenium in fish meal in comparison with soybean meal, corn gluten meal and selenomethionine relative to selenium in sodium selenite for restoring glutathione peroxidase activity in selenium-depleted chicks. *J Nutr* 110:1096-110.
- Gailer J, George GN, Pickering IJ, et al. 2000a. A metabolic link between arsenite and selenite: The seleno-bis(S-glutathionyl) arsinium ion. *J Am Chem Soc* 122:4637-4639.
- *Gailer J, George GN, Pickering IJ, et al. 2000b. Structural basis of the antagonism between inorganic mercury and selenium in mammals. *Chem Res Toxicol* 13:1135-1142.
- *Gairola C, Chow CK. 1982. Dietary selenium, hepatic arylhydrocarbon hydroxylase and mutagenic activation of benzo[a]pyrene, 2-aminoanthracene and 2-aminofluorene. *Toxicol Lett* 11:281-287.
- *Galgan V, Frank A. 1995. Survey of bioavailable selenium in Sweden with the moose (*Alces alces* L.) as monitoring animal. *Sci Total Environ* 172:37-45.
- Gallegos A, Berggren M, Gasdaska JR, et al. 1997. Mechanisms of the regulation of thioredoxin reductase activity in cancer cells by the chemopreventive agent selenium. *Cancer Res* 57:4965-4970.
- Galloway SM. 1996. The micronucleus test and NTP rodent carcinogens: Not so many false negatives. *Mutat Res* 352:185-188.
- *Ganther HE. 1971. Reduction of the selenotrisulfide derivative of glutathione to a persulfide analog by glutathione reductase. *Biochemistry* 10:4089-4098.
- *Ganther HE. 1979. Metabolism of hydrogen selenide and methylated selenides. *Adv Nutr Res* 2:107-128.

9. REFERENCES

- Ganther HE. 1980. Interactions of vitamin E and selenium with mercury and silver. *Ann NY Acad Sci* 355:212-225.
- *Ganther HE. 1999. Selenium metabolism, selenoproteins and mechanisms of cancer prevention: Complexities with thioredoxin reductase. *Carcinogenesis* 20(9):1657-1666.
- Ganther HE, Baumann CA. 1962. Selenium metabolism. I. Effects of diet, arsenic and cadmium. *J Nutr* 77:210-216.
- *Ganther HE, Lawrence JR. 1997. Chemical transformations of selenium in living organisms: Improved forms of selenium for cancer prevention. *Tetrahedron* 53(36):12299-12310.
- *Ganther HE, Levander OA, Baumann CA. 1966. Dietary control of selenium volatilization in the rat. *J Nutr* 88:55-60.
- *Ganther HS, Goudie C, Sunde ML, et al. 1972. Selenium: Relation to decreased toxicity of methylmercury added to diets containing tuna. *Science* 175:1122-1124.
- Gao N, Hopke PK, Reid NW. 1996. Possible sources for some trace elements found in airborne particles and precipitation in Dorset, Ontario. *J Air Waste Manage Assoc* 46:1035-1047.
- Gao S, Tanji KK. 1995. Model for biomethylation and volatilization of selenium from agricultural evaporation ponds. *J Environ Qual* 24:191-197.
- Gao X, Zhang J, Zhang L. 2000. [Acute toxicity and bioavailability of nano red elemental selenium]. *29(1):57-58. (Chinese).*
- Garberg P, Thullberg M. 1996. Decreased glutathione peroxidase activity in mice in response to nafenopin is caused by changes in selenium metabolism. *Chem Biol Interact* 99:165-177.
- *Garland M, Willett WC, Manson JE, et al. 1993. Antioxidant micronutrients and breast cancer. *J Am Coll Nutr* 12(4):400-411.
- *Gasiewicz TA, Smith JC. 1978. The metabolism of selenite by intact rat erythrocytes *in vitro*. *Chem Biol Interact* 21:299-313.
- *Gasmi A, Garnier R, Galliot-Guilley M, et al. 1997. Acute selenium poisoning. *Vet Hum Toxicol* 39(5):304-308.
- *Gathwala G, Yadav OP. 2002. Selenium in neonate. *Indian J Pediatr* 69:443-446.
- *Gebre-Medhin M, Ewald U, Tuverno T. 1988. Serum selenium is related to low density lipoproteins in healthy children but not in children with diabetes. *Upsala Journal of Medical Sciences* 93:57-62.
- *Geering HR, Cary EE, Jones LHP, et al. 1968. Solubility and redox criteria for the possible forms of selenium in soils. *Soil Science Society of America Proceedings* 32:35-40.
- *Gerhardsson L, Brune D, Nordberg G, et al. 1986. Selenium and other trace elements in lung tissue in smelter workers relationship to the occurrence of lung cancer. *Acta Pharmacol Toxicol* 59 (Suppl7):256-259.

9. REFERENCES

- Germani MS, Zoller WH. 1988. Vapor-phase concentrations of arsenic selenium bromine iodine and mercury in the stack of a coal-fired power plant. *Environ Sci Technol* 22(9):1079-1085.
- *Gerritse RG, Vriesema R, Dalenberg JW, et al. 1982. Effect of sewage sludge on trace element mobility in soils. *J Environ Qual* 11:359-364.
- Gervais JA, Rosenberg DK, Fry DM, et al. 2000. Burrowing owls and agricultural pesticides: Evaluation of residues and risks for three populations in California, USA. *Environ Toxicol Chem* 19(2):337-343.
- Ghosh R, Chakraborty S, Chatterjee M. 1995. Epidemiology of cancer in relation to environmental selenium status in different districts of West Bengal, India [Abstract]. *Anticancer Res* 15(5A):1654.
- *Gillum RF. 1996. Hyperpigmentation associated with selenium sulfide lotion. *J Natl Med Assoc* 88(9):551.
- Giovannucci E. 1998. Selenium and risk of prostate cancer. *Lancet* 352:755-756.
- *Giwercman A, Carlsen E, Keiding N, et al. 1993. Evidence for increasing incidence of abnormalities of the human testis: A review. *Environ Health Perspect Suppl* 101(2):65-71.
- *Gladyshev VN, Kryukov GV. 2001. Evolution of selenocysteine-containing proteins: Significance of identification and functional characterization of selenoproteins. *Biofactors* 14:87-92.
- *Glenn MW, Jensen R, Griner LA. 1964a. Sodium selenate toxicosis: Pathology and pathogenesis of sodium selenate toxicosis in sheep. *Am J Vet Res* 25:1486-1494.
- *Glenn MW, Jensen R, Griner LA. 1964b. Sodium selenate toxicosis: The effects of extended oral administration of sodium selenate on mortality, clinical signs, fertility, and early embryonic development in sheep. *Am J Vet Res* 25:1479-1485.
- Glenn MW, Jensen R, Griner LA. 1964c. Sodium selenate toxicosis: The distribution of selenium within the body after prolonged feeding of toxic quantities of sodium selenate to sheep. *Am J Vet Res* 25:1495-1499.
- Glinska S, Gabara B. 1999. Comparative analysis of selenium effects on *Allium sativum* and *Pisum sativum* roots. *Acta Physiol Plant* 21(Suppl. 3):20.
- *Glooschenko WA, Arafat N. 1988. Atmospheric deposition of arsenic and selenium across Canada using *Sphagnum* moss as a biomonitor. *Sci Total Environ* 73(3):269-275.
- *Glover JR. 1967. Selenium in human urine: A tentative maximum allowable concentration for industrial and rural populations. *Ann Occup Hyg* 10:3-10.
- *Glover JR. 1970. Selenium and its industrial toxicology. *Indust Med* 39(1):50-53.
- *Glover J, Levander O, Parizek J, et al. 1979. Selenium. In: Friberg L, Norberg GF, Vouk VB, eds. *Handbook on the toxicology of metals*. Amsterdam: Elsevier/North Holland Biomedical Press, 555-557.
- Göçmen C, Kumcu EK, Seçilmis A, et al. 2000. Restorative effects of zinc and selenium on nitrenergic relaxations impaired by cadmium in the mouse corpus cavernosum. *Toxicol Lett* 111:229-234.

9. REFERENCES

- *Goehring RB, Palmer IS, Olson OE, et al. 1984. Toxic effects of selenium growing swine fed corn-soybean meal diets. *J Anim Sci* 59:733-737.
- Goehring TB, Johnson DD, Libal GW, et al. 1983. Toxicity of added selenite and the effects of its excess on performance and blood composition of growing swine fed a corn-soybean meal diet. *J Anim Sci* 57:246-247.
- Goldfrank LR, Flomenbaum NE, Lewin NA, et al., eds. 1994. Goldfrank's toxicologic emergencies. 6th ed. Stamford, CT: Appleton and Lange, 1342-1343.
- Golstein J, Corvilain B, Lamy F, et al. 1988. Effects of a selenium deficient diet on thyroid function of normal and perchlorate treated rats. *Acta Endocrinol (Copenh)* 118(4):495-502.
- Gomez-Ariza JL, Sanchez-Rodas D, Morales E, et al. 1999. Inorganic and organic selenium speciation with coupled HPLC-MW-HG-AFS. *Appl Organomet Chem* 13(10):738-787.
- Gonzalez MJ, Rodriguez JR. 1988. Inhibition of sarcoma tumorigenesis in Balb/C mice by supplemented selenium. *Nutrition Reports International* 37(1):41-46.
- *Goodman MA, Jonas E, Kaddimir JJ. 1990. The internist's compendium of drug therapy. Hoboken, NJ: Core Publishing Division Excerpta Medica, 17.
- Goodwin-Jones R. 1997. Controlling the male to female offspring ratio in ruminants using selenium. United Kingdom Patent. GB 23123845 A. Issued 12 Nov 1997.
- Gopalakrishna R, Chen Z-H, Gundimeda U. 1997a. Selenocompounds induce a redox modulation of protein kinase C in the cell, compartmentally independent from cytosolic glutathione: Its role in inhibition of tumor promotion. *Arch Biochem Biophys* 348(1):37-48.
- Gopalakrishna R, Gundimeda U, Chen Z-H. 1997b. Cancer-preventive selenocompounds induce a specific redox modification of cysteine-rich regions in Ca²⁺-dependent isoenzymes of protein kinase C. *Arch Biochem Biophys* 348(1):25-36.
- Gordon GE, Zoller H, Gladney ES. 1973. Abnormally enriched trace elements in the atmosphere. In: Hemphill DD, ed. Trace substances in environmental health. Vol. 7. Columbia, MO: University of Missouri, 167-174.
- *Gortner RA, Lewis HB. 1939. The retention and excretion of selenium after the administration of sodium selenite to white rats. *J Pharmacol Exp Ther* 67:358-364.
- *Gosselin RE, Smith RP, Hodge HC. 1984. Clinical toxicology of commercial products. 5th ed. Baltimore, MD: Williams and Wilkins, MDII-64, II-129.
- *Goyens P, Golstein J, Nsombola B, et al. 1987. Selenium deficiency as a possible factor in the pathogenesis of myxoedematous endemic cretinism. *Acta Endocrinol* 114:497-502
- Goyer RA. 1997. Toxic and essential metal interactions. *Annu Rev Nutr* 17:37-50.
- Graham RV, Blaylock BG, Hoffman FO, et al. 1992. Comparison of selenomethionine and selenite cycling in freshwater experimental ponds. *Water Air Soil Pollut* 62(1-2):25-42.

9. REFERENCES

- Grandjean P, Weihe P, Joergensen PJ, et al. 1992. Impact of maternal seafood diet on fetal exposure to mercury, selenium, and lead. *Arch Environ Health* 47(3):185-195.
- Greenman E, Phillipich MJ, Meyer CJ, et al. 1988. The effect of selenium on phagocytosis in humans. *Anticancer Res* 8(4):825-828.
- Gregus Z, Klaassen CD. 1986. Disposition of metals in rats: A comparative study of fecal, urinary, and biliary excretion and tissue distribution of eighteen metals. *Toxicol Appl Pharmacol* 85:24-38.
- Gregus Z, Perjési P, Gyurasics A. 1998. Enhancement of selenium excretion in bile by sulfobromophthalein: Elucidation of the mechanism. *Biochem Pharmacol* 56:1391-1402.
- Griffin AC, Jacobs MM. 1977. Effects of selenium on azo dye hepatocarcinogenesis. *Cancer Letters* 3:177-181.
- *Griffiths NM, Stewart RDH, Robinson MF. 1976. The metabolism of [⁷⁵Se]selenomethionine in four women. *Br J Nutr* 35:373-382.
- Gromadzinska J, Wasowicz W, Krasomski G, et al. 1998. Selenium levels, thiobarbituric acid-reactive substance concentrations and glutathione peroxidase activity in the blood of women with gestosis and imminent premature labour. *Analyst* 123:35-40.
- *Gromadzinska J, Wasowicz W, Sklodowska M, et al. 1996. The influence of atmospheric chromium on selenium content and glutathione peroxidase activity in blood of tannery workers. *Environ Health Perspect* 104(12):1312-1316.
- *Grønbæk H, Thorlacius-Ussing O. 1989. Selenium in the central nervous system of the rat after exposure to 75-Se-L-Selenomethionine. In: Wendel A, ed. *Selenium in biology and medicine*. New York, NY: Springer-Verlag.
- *Grønbæk H, Thorlacius-Ussing O. 1990. Selenium complexes in the anterior pituitary of rats exposed to L-selenomethionine. *Virchows Arch B Cell Pathol* 59(5):291-296.
- *Grønbæk Thorlacius-Ussing O. 1992. Selenium in the central nervous system of rats exposed to 75-Se L-selenomethionine and sodium selenite. *Biol Trace Elem Res* 35(2):119-127.
- *Grønbæk H, Frystyk J, Ørskov H, et al. 1995. Effect of sodium selenite on growth, insulin-like growth factor-binding proteins and insulin-like growth factor-I in rats. *J Endocrinol* 145:105-112.
- *Gruenwald P. 1958. Malformation caused by necrosis in the embryo illustrated by the effects of selenium compounds on chick embryo. *Am J Pathol* 34:77-95.
- Gu J, Su T, Chen Y, et al. 1999. Expression of biotransformation enzymes in human fetal nasal mucosa. *Toxicologist* 48(1-S):403.
- Guidi GC, Bellisola G, Bonadonna G, et al. 1990. Selenium supplementation increases renal glomerular filtration rate. *J Trace Elem Electrolytes Health Dis* 4(3):157-161.

9. REFERENCES

Guilmette RA, Muggenburg BA. 1988. Reducing the radiation dose from inhaled americium-241 using continuously administered DTPA therapy. *Int J Radiat Biol* 53(2):261-271.

Guimarães MJ, Peterson D, Vicari A, et al. 1996. Identification of a novel *selD* homolog from Eukaryotes, Bacteria, and Archaea: Is there an autoregulatory mechanism in selenocysteine metabolism? *Proc Natl Acad Sci U S A* 93:15086-15091.

Gutenmann WH, Bache CA, Youngs WD, et al. 1976. Selenium in fly ash. *Science* 191:966-967.

*Guvenc M, Guvenc H, Karatas F et al. 2002. Low levels of selenium in miscarriage. *J Trace Elem Exp Med* 15:97-101.

*Guzelian PS, Henry CJ, Olin SS, eds. 1992. Similarities and differences between children and adults: Implications for risk assessment. Washington, DC: International Life Sciences Institute Press.

Hac E, Krechniak J, Szyszko M, et al. 2001. Selenium in human renal cortex, liver, and hair in Poland. *Toxicol Lett* 123:70.

Hac E, Krechniak J, Szyszko M. 2002. Selenium levels in human plasma and hair in northern Poland. *Biol Trace Elem Res* 85(3):277-285.

*Hadjimarkos DM. 1963. Selenium content of human milk: Possible effect on dental caries. *J Pediatr* 63:273-275.

*Hadjimarkos DM. 1969a. Selenium toxicity: Effect of fluoride. *Experientia* 25:485-486.

*Hadjimarkos DM. 1969b. Selenium: A caries enhancing trace element. *Caries Res* 3:14-22.

Hadjimarkos DM, Bonhorst CW. 1961. The selenium content of eggs, milk, and water in relation to dental caries. *J Pediatr* 59:256-259.

*Hadjimarkos DM, Bonhorst CW, Mattice JJ. 1959. The selenium concentration in placental tissue and fetal cord blood. *J Pediatr* 54:296-298.

*Haga P, Lunde G. 1978. Selenium and vitamin E in cord blood from preterm and full term infants. *Acat Paediatr Scand* 67:135-139.

*Hagmar L, Persson-Moschos M, Åkesson B, et al. 1998. Plasma levels of selenium, selenoprotein P and glutathione peroxidase and their correlations to fish intake and serum levels of thyrotropin and thyroid hormones: A study on Latvian fish consumers. *Eur J Clin Nutr* 52:796-800.

Hahn MH, Kuennen RW, Caruso JA, et al. 1981. Determination of trace amounts of selenium in corn, lettuce, potatoes, soybeans, and wheat by hydride generation/condensation and flame atomic absorption spectrometry. *J Agric Food Chem* 29:792-796.

*Hall RH, Laskin S, Frank P, et al. 1951. Preliminary observations on toxicity of elemental selenium. *AMA Arch Ind Hyg Assoc* 4:458-464.

Halverson AW. 1974. Growth and reproduction with rats fed selenite-Se. *Proc S Dakota Acad Sci* 53:167-177.

9. REFERENCES

- *Halverson AW, Monty KJ. 1960. An effect of dietary sulfate on selenium poisoning in the rat. *J Nutr* 70:100-102.
- *Halverson AW, Ding-Tsay D, Triebwasser KC, et al. 1970. Development of hemolytic anemia in rats fed selenite. *Toxicol Appl Pharmacol* 17:151-159.
- *Halverson AW, Guss PL, Olson OE. 1962. Effect of sulfur salts on selenium poisoning in the rat. *J Nutr* 77:459-464.
- *Halverson AW, Palmer IS, Guss PL. 1966. Toxicity of selenium to post-weanling rats. *Toxicol Appl Pharmacol* 9:477-484.
- Hamada R, Arimura K, Osame M. 1997. Maternal-fetal mercury transport and fetal methylmercury poisoning. In: Sigel A, Sigel H, eds. *Metal ions in biological systems: Mercury and its effects on environment and biology*. New York, NY: Marcel Dekker, Inc., 406-420.
- *Hamilton A, Hardy HL. 1949. *Selenium in industrial toxicology*. New York, NY: Hoeber, Inc., 188-192.
- Han C, Li Y, Li L, et al. 1996. [Influence of selenium and lead on sperm abnormalities in mice]. *Yanbian Yixueyuan Xuebao* 19(4):208-209. (Chinese).
- Handel ML, Watts CK, DeFazio a, et al. 1995. Inhibition of AP-1 binding and transcription by gold and selenium involving conserved cysteine residues in Jun and Fos. *Proc Natl Acad Sci U S A* 92:4497-4501.
- Handelman GJ, Kosted P, Short S, et al. 1989. Determination of selenium in human blood by high-performance liquid chromatography with fluorescence detection. *Anal Chem* 61(20):2244-2249.
- *Hansen JC. 1988. Has selenium a beneficial role in human exposure to inorganic mercury? *Med Hypotheses* 25(1):45-53.
- *Hansen JC, Deguchi Y. 1996. Selenium and fertility in animals and man – a review. *Acta Vet Scan* 37(1):19-30.
- Hansen JC, Kristensen P. 1979. The kinetics of ⁷⁵Se-selenium in relation to dose and mode of administration in mice. *J Nutr* 109:1223-1233.
- Hansson L, Pettersson J, Eriksson L, et al. 1989. Atomic absorption spectrometric determination of selenium in human blood components. *Clin Chem* 35(4):537-540.
- Hansson L, Pettersson J, Olin A. 1989. Determination of selenium in fish flesh by hydride generation atomic absorption spectrometry. *Analyst* 114(4):527-528.
- Haraldsson C, Pollak M, Oehman P. 1992. Simultaneous determination of antimony, arsenic and selenium in natural waters by means of hydride generation coupled to plasma source mass spectrometry. *J Anal Atomic Spectr* 7(8):1183-1186.
- *Hardell L, Danell M, Angqvist CA, et al. 1993. Levels of selenium in plasma and glutathione peroxidase in erythrocytes and the risk of breast cancer. A case control study. *Biol Trace Elem Res* 36(2):99-108.

9. REFERENCES

- *Harr JR. 1978. Biological effects of selenium. In: Oehme FW, ed. Toxicity of heavy metals in the environment, Part I. New York, NY: Marcel Dekker, 393-426.
- *Harr JR, Muth OH. 1972. Selenium poisoning in domestic animals and its relationship to man. Clin Toxicol 5:175-186.
- *Harr JR, Bone JF, Tinsley IJ, et al. 1967. Selenium toxicity in rats. II. Histopathology. In: Muth OH, Oldfield JE, Weswig PH, eds. Selenium Biomed Proc 1st Int Symp, Oregon State Univ, 1966. Westport, CT: AVI Publishing Co, 153-178.
- *Harrison I, Littlejohn D, Fell GS. 1996. Distribution of selenium in human blood plasma and serum. Analyst 121:189-194.
- *Harrison LH, Colvin BM, Stuart BP, et al. 1983. Paralysis in swine due to focal symmetrical poliomalacia: Possible selenium toxicosis. Vet Pathol 20:265-273.
- Harrison PR, Lanfear J, Wu L, et al. 1997. Chemopreventive and growth inhibitory effects of selenium. Biomed Environ Sci 10:235-245.
- *Harrison PR, Rahn KA, Dams R, et al. 1971. Area wide trace metal concentrations measured by multielement neutron activation analysis - one day study in north-west Indiana. J Air Pollut Control Assoc 21:563-570.
- *Hasegawa T, Mihara M, Okuno T. 1995. Chemical form of selenium-containing metabolite in small intestine and liver of mice following orally administered selenocystine. Arch Toxicol 69:312-317.
- Hasegawa T, Mihara M, Nakamuro K, et al. 1996a. Mechanisms of selenium methylation and toxicity in mice treated with selenocystine. Arch Toxicol 71:31-38.
- *Hasegawa T, Okuno T, Nakamuro K, et al. 1996b. Identification and metabolism of selenocysteine-glutathione selenenyl sulfide (CySeSG) in small intestine of mice orally exposed to selenocystine. Arch Toxicol 71:39-44.
- Hasegawa T, Okuno T, Sayato Y, et al. 1996c. [Mechanisms of liver toxicity in mice repeated oral administration of selenocystine]. Biomed Res Trace Elements 7(3):211-212. (Japanese).
- *Hasegawa T, Taniguchi S, Mihara M, et al. 1994. Toxicity and chemical form of selenium in the liver of mice orally administered selenocystine for 90 days. Arch Toxicol 68:91-95.
- *Hashimoto Y, Winchester JW. 1967. Selenium in the atmosphere. Environ Sci Technol 1:338-340.
- *Hashimoto Y, Hwang JT, Yanagisawa S. 1970. Possible source of atmospheric pollution of selenium. Environ Sci Technol 4:157-158.
- Hasunuma R, Ogawa T, Fujise Y, et al. 1993. Analysis of selenium metabolites in urine samples of minke whale (*Balaenoptera acutorostrata*) using ion exchange chromatography. Comp Biochem Physiol [C] 104(1):87-89.
- *Hasunuma R, Ogawa T, Kawanishi Y. 1982. Fluorometric determination of selenium in nanogram amounts in biological materials using 2,3-diaminonaphthalene. Anal Biochem 126:242-245.

9. REFERENCES

- Hasunuma R, Ogawa T, Kawanishi Y. 1993. Analysis of selenium metabolites in human urine using ion exchange chromatography. *Bull Environ Contam Toxicol* 50(1):19-23.
- Hasunuma R, Tsuda M, Ogawa T, et al. 1993. Selenium metabolite levels in human urine after dosing selenium in different chemical forms. *Bull Environ Contam Toxicol* 51:756-763.
- Hasunuma R, Tsuda M, Ogawa T, et al. 1990. Urinary selenium levels in Japanese males and females. *Bull Environ Contam Toxicol* 44(4):501-507.
- *WC, Hornbostel L. 1996. Effects of dietary selenium on mood in healthy men living in a metabolic research unit. *Biol Psychiatry* 39:121-128.
- *Hawkes WC, Keim NL. 1995. The effect of selenium (Se) on triiodothyronine (T₃) and weight changes in healthy men in a metabolic research unit. *FASEB J* 9(5):A160.
- *Hawkes WC, Turek P. 2001. Effect of dietary selenium on sperm motility in healthy men. *J Androl* 22(5):764-772.
- *Hawkes WC, Kelley DS, Taylor PC. 2001. The effects of dietary selenium on the immune system in healthy men. *Biol Trace Elem Res* 81:189-213.
- *Hawkes WC, Willhite CC, Craig KA, et al. 1992. Effects of excess selenomethionine on selenium status indicators in pregnant long-tailed macaques (*Macaca fascicularis*). *Biol Trace Elem Res* 35(3):281-297.
- *Hawkes WC, Willhite CC, Omaye ST, et al. 1994. Selenium kinetics, placenta transfer, and neonatal exposure in cynomolgus macaques (*Macaca fascicularis*). *Teratology* 50:148-159.
- HazDat. 1996. Agency for Toxic Substances and Disease Registry (ATSDR), Atlanta, GA.
- HazDat. 2001. Agency for Toxic Substances and Disease Registry (ATSDR), Atlanta, GA.
- *HazDat. 2003. Agency for Toxic Substances and Disease Registry (ATSDR), Atlanta, GA.
- *Heese HD, Lawrence MA, Dempster WS, et al. 1988. Reference concentrations of serum selenium and manganese in healthy nulliparas. *S Afr Med J* 73(3):163-165.
- *Heinrich MJ, Kelsey FE. 1955. Studies on selenium metabolism: The distribution of selenium in the tissues of the mouse. *J Pharmacol Exp Ther* 114:28-32.
- *Heiny JS, Tate CM. 1997. Concentration, distribution, and comparison of selected trace elements in bed sediment and fish tissue in the South Platte River Basin, USA, 1992-1993. *Arch Environ Contam Toxicol* 32:246-259.
- Hélie P, Sauvageau RA. 1998. Chronic selenium toxicosis in growing-finishing pigs in southwestern Québec. *Can Vet J* 39:591-592.
- *Helzlsouer K, Jacobs R, Morris S. 1985. Acute selenium poisoning in the United States. *Federation Proceedings* 44:1670.

9. REFERENCES

- *Hendler SS. 1990. The doctor's vitamin and mineral encyclopedia. New York, NY: Simon & Shuster, 183-193.
- *Henschler D, Kershner U. 1969. Short report on the absorption and toxicity of selenium sulfide. *Arch Toxicol* 24:341-344. (German).
- Herigstad RR, Whitehair CK, Olson OE. 1973. Inorganic and organic selenium toxicosis in young swine: Comparison of pathologic changes with those in swine with vitamin E-selenium deficiency. *Am J Vet Res* 34:1227-1238.
- *Heydorn K, Griepink B. 1990. Selection of reference methods for the determination of selenium in biological materials. *F J Anal Chem* 338(3):287-292.
- *Higashi A, Tamari H, Kuroki Y. 1983. Longitudinal changes in selenium content of breast milk. *Acta Pediatr Scand* 72:433-436.
- Hightower KR, McCready JP. 1991. Effect of selenite on epithelium of cultured rabbit lens. *Invest Ophthalmol Vis Sci* 32(2):406-409.
- Hill J, Allison F, Halpin C. 1985. An episode of acute selenium toxicity in a commercial piggery. *Aust Vet J* 62:207-209.
- *Hill KE, Burk RF. 1989. Glutathione metabolism as affected by selenium deficiency. In: Wendel A, ed. *Selenium in biology and medicine*. Springer-Verlag, 97-100.
- *Hirooka T, Galambos JT. 1966a. Selenium metabolism. III. Serum proteins, lipoproteins and liver injury. *Biochim Biophys Acta* 130:321-328.
- *Hirooka T, Galambos JT. 1966b. Selenium metabolism. I. Respiratory excretion. *Biochim Biophys Acta* 130:313-320.
- Ho MH, Dillon HK. 1986. Biological monitoring. *Environ Sci Technol* 20:124-127.
- Hocman G. 1988. Chemoprevention of cancer: selenium. *Int J Biochem* 20(2):123-132.
- Hodson PV. 1990. Indicators of ecosystem health at the species level and example of selenium effects on fish. *Environmental Monitor Assessment* 15(3):241-254.
- *Hoel DG, Davis DL, Miller AB, et al. 1992. Trends in cancer mortality in 15 industrialized countries, 1969-1986. *J Natl Cancer Inst* 84(5):313-320.
- *Hoening M, Van Hoeyweghen P. 1986. Determination of selenium and arsenic in animal tissues with platform furnace atomic absorption spectrometry and deuterium background correction. *Int J Environ Anal Chem* 24:193-202.
- *Hofbauer LC, Spitzweg C, Magerstädt RA, et al. 1997. Selenium-induced thyroid dysfunction. *Postgrad Med J* 73(856):103-104.
- Hoffman DJ, Heinz GH, Krynitsky AJ. 1989. Hepatic glutathione metabolism and lipid peroxidation in response to excess dietary selenomethionine and selenite in mallard ducklings. *J Toxicol Environ Health* 27(2):263-271.

9. REFERENCES

- Hoffman DJ, Sanderson CJ, LeCaptain LJ, et al. 1991. Interactive effects of boron, selenium, and dietary protein on survival, growth, and physiology in mallard ducklings. *Arch Environ Contam Toxicol* 20(2):288-294.
- Hoffman DJ, Sanderson CJ, LeCaptain LJ, et al. 1992. Interactive effects of arsenate, selenium, and dietary protein on survival, growth, and physiology in mallard ducklings. *Arch Environ Contam Toxicol* 22(1):55-62.
- *Hoffman JE, King MG. 1997. Selenium and selenium compounds. In: Kroschwitz JJ, Howe-Grant MH, ed. *Encyclopedia of chemical technology*. New York, NY: John Wiley & Sons, 686-719.
- Hoffmann P, Dedik AN, Deutsch F, et al. 1997. Solubility of single chemical compounds from an atmosphere aerosol in pure water. *Atmos Environ* 31(17):2777-2785.
- Hogan GR, Pendleton RE. 1996. Comparative split dose effects of selenate and selenomethionine on erythropoiesis of mice. *Bull Environ Contam Toxicol* 56:622-629.
- *Hojo Y. 1981a. Subject groups high and low in urinary selenium levels: Workers exposed to heavy metals and patients with cancer and epilepsy. *Bull Environ Contam Toxicol* 26:466-471.
- *Hojo Y. 1981b. Evaluation of the expression of urinary selenium levels as ng Se/mg creatinine and the use of single-void urine as a sample for urinary selenium determination. *Bull Environ Contam Toxicol* 27:213-220.
- *Hojo Y. 1982. Single-void urine selenium level expressed in terms of creatinine content as an effective and convenient indicator of human selenium status. *Bull Environ Contam Toxicol* 29:37-42.
- *Hojo Y. 1987. Selenium and glutathione peroxidase in human saliva and other human body fluids. *Sci Total Environ* 65:85-94.
- *Holmberg RE, Ferm VH. 1969. Interrelationships of selenium, cadmium, and arsenic in mammalian teratogenesis. *Arch Environ Health* 18:873-877.
- *Holmgren A, Kumar S. 1989. Reactions of the thioredoxin system with selenium. In: Wendel A, ed. *Selenium in biology and medicine*. New York, NY: Springer-Verlag, 47-51.
- *Holness DL, Taraschuk IG, Nethercott JR. 1989. Health status of copper refinery workers with specific reference to selenium exposure. *Arch Environ Health* 44(5):291-297.
- Holsbeek L, Joiris CR, Debacker V, et al. 1999. Heavy metals, organochlorines and polycyclic aromatic hydrocarbons in sperm whales stranded in the southern North Sea during the 1994/1995 winter. *Mar Pollut Bull* 38(4):304-313.
- Hopkins WA, Mendonca MT, Rowe CL, et al. 1998. Elevated trace element concentrations in southern toads, *Bufo terrestris*, exposed to coal combustion waste. *Arch Environ Contam Toxicol* 35:325-329.
- *Hopper SA, Greig A, McMurray CH. 1985. Selenium poisoning in lambs. *Vet Rec* 116:569-571.

9. REFERENCES

- *Horne AJ. 1991. Selenium detoxification in wetlands by permanent flooding: I. Effects on a macroalga, an epiphytic herbivore, and an invertebrate predator in the long-term mesocosm experimental at Kesterson Reservoir, California. *Water Air Soil Pollut* 57-58:43-52.
- Hornstein VO, Czöndör J, Rang H. 1998. [Selenium intoxication in postweaning piglets]. *Tieraewztliche Umschau* 53:547-554. (German).
- Hossner LR, Woodard HJ, Bush J. 1992. Growth and selenium uptake of range plants propagated in uranium mine soils. *J Plant Nutr* 15(12):2743-2761.
- *Hotz CS, Fitzpatrick DW, Trick KD, et al. 1997. Dietary iodine and selenium interact to affect thyroid hormone metabolism of rats. *J Nutr* 127:1214-1218.
- House WA, Welch RM. 1989. Bioavailability of and interactions between zinc and selenium in rats fed wheat grain intrinsically labeled with ⁶⁵Zn and ⁷⁵Se. *J Nutr* 119(6):916-921.
- *Howe M. 1979. Selenium in the blood of South Dakotans. *Arch Environ Health* 34:444-448.
- HSDB. 1995. Hazardous Substances Data Bank. National Library of Medicine, Bethesda, MD.
- *HSDB. 2001. Hazardous Substances Data Bank. National Library of Medicine, Bethesda, MD. March 2, 2001.
- *Hsieh HS, Ganther HE. 1975. Acid-volatile selenium formation catalyzed by glutathione reductase. *Biochemistry* 14:1632-1636.
- Hu Q, Chen L, Xu J, et al. 2002. Determination of selenium concentration in rice and the effect of foliar application of Se-enriched fertiliser or sodium selenite on the selenium content of rice. *J Sci Food Agric* 82(8):869-872.
- Huang LL, Hess JL, Bunce GE. 1990. DNA damage, repair, and replication in selenite-induced cataract in rat lens. *Curr Eye Res* 9(11):1041-1050.
- Huang LL, Zhang CY, Hess JL, et al. 1992. Biochemical changes and cataract formation in lenses from rats receiving multiple, low doses of sodium selenite. *Exp Eye Res* 55(5):671-678.
- *Huang W, Akesson B, Svensson BG. 1995. Selenoprotein P and glutathione peroxidase (EC 1.11.1.9) in plasma as indices of selenium status in relation to the intake of fish. *Br J Nutr* 73:455-461.
- *Hunter DJ, Manson JE, Colditz GA, et al. 1993. A prospective study of the intake of vitamins C, E, and A and the risk of breast cancer. *N Engl J Med* 329(4):234-240.
- *Hunter DJ, Morris JS, Chute CG, et al. 1990a. Predictors of selenium concentration in human toenails. *Am J Epidemiol* 132(1):114-122.
- *Hunter DJ, Morris JS, Stampfer MJ, et al. 1990b. A prospective study of selenium status and breast cancer risk [see comments]. *JAMA* 264(9):1128-1131.
- Hunter ES. 1998. Selenite prevents the dysmorphology and early phase cell cycle changes produced by arsenite in mouse embryos in culture [Abstract]. *Teratology* 57(4/5):215-216.

9. REFERENCES

- *IARC. 1975a. IARC monographs on the evaluation of carcinogenic risk of chemicals to man: Some aziridines, N-, S-, & O-mustards and selenium. Vol. 9. Lyon, France: World Health Organization, International Agency for Research on Cancer.
- IARC. 1975b. IARC monographs on the evaluation of the carcinogenic risk of chemicals to humans: Selenium. World Health Organization, International Agency for Research on Cancer. *Eval Carcinog Risk Chem Hum* 9:245-260.
- *IARC. 1987. IARC monographs on the evaluation of the carcinogenic risk of chemicals to humans: Summary table. Lyon, France: World Health Organization, International Agency for Research on Cancer *Supp* 7:71.
- *IARC. 1994. IARC monographs on the evaluation of carcinogenic risk of chemicals to humans: Lists of IARC evaluations. Lyon, France: World Health Organization, International Agency for Research on Cancer.
- *IARC. 2001. Selenium and selenium compounds: Summary of data reported and evaluation. Lyon, France: World Health Organization, International Agency for Research on Cancer. <http://193.51.164.11/htdocs/Monographs/Vol09/Selenium.html>. February 22, 2001.
- *Imahori A, Fukushima J, Shiobara S, et al. 1979. Multielement neutron activation analysis of human scalp hair: a local population survey in the Tokyo metropolitan area. *J Radioanal Chem* 52(1):167-180.
- *Imbach A, Sternberg J. 1967. Metabolic studies with seleniated compounds. I. Kinetic studies with $^{75}\text{SeO}_3$ in rats. *Int J Appl Radiat Isot* 18:545-556.
- *Innes JRM, Ulland BM, Valerio MG, et al. 1969. Bioassay of pesticides and industrial chemicals for tumorigenicity in Mice: A preliminary note. *J Natl Cancer Inst* 42:1101-1114.
- *Ip C. 1981. Prophylaxis of mammary neoplasia by selenium supplementation in the initiation and promotion phases of chemical carcinogenesis. *Cancer Res* 41:4386-4390.
- *Ip C. 1983. Selenium-mediated inhibition of mammary carcinogenesis. *Biol Trace Elem Res* 5:317-330.
- Ip C. 1986. Interaction of vitamin C and selenium supplementation in the modification of mammary carcinogenesis in rats. *J Natl Cancer Inst* 77:299-303.
- Ip C, Ganther H. 1992. Biological activities of trimethylselenium as influenced by arsenite. *J Inorg Biochem* 46(3):215-222.
- *Ip C, Hayes C. 1989. Tissue selenium levels in selenium-supplemented rats and their relevance in mammary cancer protection. *Carcinogenesis* 10(5):921-925.
- *Ip C, Lisk DJ. 1995. Efficacy of cancer prevention by high-selenium garlic is primarily dependent on the action of selenium. *Carcinogenesis* 16(11):2649-2652.
- *Ip C, Lisk DJ. 1996. The attributes of selenium-enriched garlic in cancer prevention. In: American Institute for Cancer Research, eds. *Dietary phytochemicals in cancer prevention and treatment*. New York, NY: Plenum Press, 179-187.

9. REFERENCES

- *Ip C, Birringer M, Block E, et al. 2000a. Chemical speciation influences comparative activity of selenium-enriched garlic and yeast in mammary cancer prevention. *J Agric Food Chem* 48:2062-2070.
- Ip C, Hayes C, Budnick RM, et al. 1991. Chemical form of selenium, critical metabolites, and cancer prevention. *Cancer Res* 51(2):595-600.
- *Ip C, Lisk DJ, Ganther H, et al. 1997. Triphenylselenonium and diphenylselenide in cancer chemoprevention: Comparative studies of anticarcinogenic efficacy, tissue selenium levels and excretion profile. *Anticancer Res* 17:3195-3200.
- *Ip C, Lisk DJ, Ganther HE. 1998. Activities of structurally-related lipophilic selenium compounds as cancer chemopreventive agents. *Anticancer Res* 18:4019-4026.
- Ip C, Lisk DJ, Thompson HJ. 1996. Selenium-enriched garlic inhibits the early stage but not the late stage of mammary carcinogenesis. *Carcinogenesis* 17(9):1979-1982.
- *Ip C, Thompson HJ, Zhu Z, et al. 2000b. *In vitro* and *in vivo* studies of methylseleninic acid: Evidence that a monomethylated selenium metabolite is critical for cancer chemoprevention. *Cancer Res* 60:2882-2886.
- *IRIS. 1996. Integrated Risk Information System. Washington, DC: U.S. Environmental Protection Agency.
- *IRIS. 2001. Integrated Risk Information System. Washington, DC: U.S. Environmental Protection Agency. February 22, 2001.
- *IRIS. 2003. Integrated Risk Information System. Washington, DC: U.S. Environmental Protection Agency.
- Ishikawa M, Sasaki M, Koiwai K, et al. 1992. Inhibition of hepatic mixed-function oxidase enzymes in mice by acute and chronic treatment with selenium. *J Pharmacobiodyn* 15(8):377-385.
- *ITII. 1976. Toxic and hazardous industrial chemicals safety manual. Tokyo, Japan: The International Technical Information Institute, 460-461.
- *Itoh S, Shimada H. 1996. Micronucleus induction by chromium and selenium, and suppression by metallothionein inducer. *Mutat Res* 367:233-236.
- Iwai N, Watanabe C, Suzuki T, et al. 1988. Metallothionein induction by sodium selenite at two different ambient temperatures in mice. *Arch Toxicol* 62(6):447-451.
- *Iyengar GV. 1987. Reference values for the concentrations of As, Cd, Co, Cr, Cu, Fe, I, Hg, Mn, Mo, Ni, Pb, Se, and Zn in selected human tissues and body fluids. *Biol Trace Elem Res* 12:263-295.
- *Jaakkola K, Tummavuori J, Pirinen A, et al. 1983. Selenium levels in whole blood of Finnish volunteers before and during organic and inorganic selenium supplementation. *Scand J Clin Lab Invest* 1983:473-476.
- *Jacobs MM. 1983. Selenium inhibition of 1,2-Dimethylhydrazine-induced colon carcinogenesis. *Cancer Res* 43:1646-1649.

9. REFERENCES

- *Jacobs M, Forst C. 1981a. Toxicological effects of sodium selenite in Sprague-Dawley rats. *J Toxicol Environ Health* 8:575-585.
- Jacobs MM, Forst C. 1981b. Toxicological effects of sodium selenite in Swiss Mice. *J Toxicol Environ Health* 8:587-598.
- *Jacobs MM, Griffin AC. 1979. Effects of selenium on chemical carcinogenesis, comparative effects of antioxidants. *Biol Trace Elem Res* 1:1-13.
- *Jacobs MM, Forst CF, Beams FA. 1981. Biochemical and clinical effects of selenium on dimethylhydrazine-induced colon cancer in rats. *Cancer Res* 41:4458-4465.
- *Jacobs MM, Jansson B, Griffin AC. 1977a. Inhibitory effects of selenium on 1,2-dimethylhydrazine and methylazoxymethanol acetate induction of colon tumors. *Cancer Lett* 2:133-138.
- Jacobs MM, Matney TS, Griffin AC. 1977b. Inhibitory effects of selenium on the mutagenicity of 2-acetyl aminofluorene (AAF) and AAF derivatives. *Cancer Lett* 2:319-322.
- Jacobsson SO. 1966. Uptake of Se⁷⁵ in tissues of sheep after administration of a single dose of Se⁷⁵-sodium selenite, Se⁷⁵-selenomethionine, or Se⁷⁵-selenocystine. *Acta Vet Scand* 7:303-320.
- *Jaffe WG, Mondragon MC. 1969. Adaptation of rats to selenium intake. *J Nutr* 97:431-436.
- *Jaffe WG, Mondragon C. 1975. Effects of ingestion of organic selenium in adapted and non-adapted rats. *Br J Nutr* 33:387-397.
- *Jaffe WG, Ruphael MD, Mondragon MC, et al. 1972. [Clinical and biochemical study in children from a seleniferous zone.] *Arch Latinoam Nutr* 22:579-611. (Spanish).
- Jamall IS, Haldar D, Wadewitz AG. 1987. Effects of dietary selenium on lipid peroxidation, mitochondrial function and protein profiles in the heart of the myopathic Syrian golden hamster (BIO 14.6). *Biochem Biophys Res Commun* 144:815-820.
- *Jamall IS, Naik M, Sprowls JJ, et al. 1989. A comparison of the effects of dietary cadmium on heart and kidney antioxidant enzymes: Evidence for the greater vulnerability of the heart to cadmium toxicity. *J Appl Toxicol* 9(5):339-345.
- *Jamba L, Nehru B, Bansal MP. 1997. Redox modulation of selenium binding proteins by cadmium exposures in mice. *Mol Cell Biochem* 177:169-175.
- James LF, Hartley WJ, Van Kampen KR. 1981. Syndromes of Astragalus poisoning in livestock. *J Am Vet Med Assoc* 178:146-150.
- James LF, Molyneux RJ, Panter KE. 1990. The potential for the toxic principles of Astragalus and related plants to appear in meat and milk. *Vet Hum Toxicol* 32Suppl:104-109.
- *James LF, Van Kampen KV, Hartley WJ. 1983. Astragalus bisulcatus - A cause of selenium or locoweed poisoning? *Vet Hum Toxicol* 25:86-89.
- *Jandial V, Handerson P, MacGillivray I. 1976. Placental transfer of radioactive selenomethionine in late pregnancy. *Eur J Obstet Gynecol Reprod Biol* 6:295-300.

9. REFERENCES

- Janghorbani M, Christensen MJ, Nahapetian A, et al. 1982. Selenium metabolism in health adults: Quantitative aspects using the stable isotope $^{74}\text{SeO}_3(2-)$. *Am J Clin Nutr* 35:647-654.
- Janghorbani M, Lynch NE, Mooers CS, et al. 1990a. Comparison of the magnitude of the selenite-exchangeable metabolic pool and whole body endogenous selenium in adult rats. *J Nutr* 120(2):190-199.
- Janghorbani M, Rockway S, Mooers CS, et al. 1990b. Effect of chronic selenite supplementation on selenium excretion and organ accumulation in rats. *J Nutr* 120(3):274-279.
- Janghorbani M, Martin RF, Kasper LJ, et al. 1990c. The selenite-exchangeable metabolic pool in humans: A new concept for the assessment of selenium status. *Am J Clin Nutr* 51(4):670-677.
- Janke BH. 1989. Acute selenium toxicosis in a dog. *J Am Vet Med Assoc* 195(8):1114-1115.
- Jansson B, Jacobs MM, Griffin AC. 1978. Gastrointestinal cancer: Epidemiology and experimental studies. *Adv Exp Med Biol* 91:305-321.
- Jastrzebski Z, Czyzewska-Szafran H, Fijatek Z, et al. 1995. Toxicity studies of a new selenium compound, Selol, in rats. *Drugs Exp Clin Res* 21(6):217-220.
- Jastrzebski Z, Czyzewska-Szafran H, Remiszewska M, et al. 1997. Pharmacokinetics of Selol, a new agent containing selenium, in rats. *Drugs Exp Clin Res* 23(1):7-11.
- *Jensen R, Closson W, Rothenberg R. 1984. Selenium intoxication - New York. *JAMA* 251:1938.
- *Jereb M, Falk R, Jereb B, et al. 1975. Radiation dose to the human body from intravenously administered ^{75}Se -sodium selenite. *J Nucl Med* 16:846-850.
- Ji Q, Chen Y. 1996. *Vicia faba* root tip micronucleus test on the mutagenicity of water-soluble contents of cigarette smoke. *Mutat Res* 359:1-6.
- *Jiang C, Jiang W, Ip C, et al. 1999. Selenium-induced inhibition of angiogenesis in mammary cancer at chemopreventive levels of intake. *Mol Carcinog* 26:213-225.
- *Jiang S, Robberect H, Vanden Berghe D. 1983. Elimination of selenium compounds by mice through formation of different volatile selenides. *Experientia* 39:293-294.
- *Johanson CE. 1980. Permeability and vascularity of the developing brain: Cerebellum vs cerebral cortex. *Brain Res* 190:3-16.
- Johansson E, Plantin L-O, Galgan V, et al. 1989. Comparison of human response to low doses of inorganic and organic selenium. In: Wendel A, ed. *Selenium in biology and medicine*. New York, NY: Springer-Verlag, 258-262.
- *John W, Kaifer JW, Rahm K, et al. 1973. Trace element concentrations in aerosols from the San Francisco Bay area. *Atmos Environ* 7:107-118.
- *Johnson H. 1970. Determination of selenium in solid waste. *Environ Sci Technol* 4:850-853.

9. REFERENCES

- *Johnson RA, Baker SS, Fallon JT, et al. 1981. An occidental case of carcinogenicity and selenium deficiency. *N Engl J Med* 304:1210-1212.
- *Johnson VJ, Tsunoda M, Sharma RP. 2000. Increased production of proinflammatory cytokines by murine macrophages following oral exposure to sodium selenite but not to seleno-L-methionine. *Arch Environ Contam Toxicol* 39:243-250.
- Jones GB, Godwin KO. 1962. Distribution of radioactive selenium in mice. *Nature* 196:1294-1296.
- *Jones MM, Xu C, Ladd PA. 1997. Selenite suppression of cadmium-induced testicular apoptosis. *Toxicology* 116:169-175.
- *Kabatas-Pendias A, Pendias H. 1984. Trace elements in soils and plants. Boca Raton, FL: CRC Press, p.135-136.
- Kaech M, Lu J, Strange R, et al. 1997. Differential induction of growth arrest inducible genes by selenium compounds. *Biochem Pharmacol* 53:921-926.
- *Kalivas J. 1993. Lack of serum selenium rise after overnight application of selenium sulfide. *Arch Dermatol* 129:646-648.
- Kallistratos G, Evangelou A, Seferiadis K, et al. 1985. Selenium and haemodialysis: Serum selenium levels in healthy persons, non-cancer and cancer patients with chronic renal failure. *Nephron* 41:217-222.
- Kallistratos GI, Fasske EE, Karkabounas S, et al. 1988. Prolongation of the survival time of tumor bearing Wistar rats through a simultaneous oral administration of vitamins C + E and selenium with glutathione. In: Tryfiates GP, Prasad KN, eds. Nutrition, growth, and cancer. Proceedings of the First International Symposium on Nutrition, Growth, and Cancer, Athens, Greece, April 26-30, 1987. New York, NY: Alan R Liss, 377-389.
- *Kamstra LD, Bonhorst CW. 1953. Effect of arsenic on the expiration of volatile selenium compounds by rats. *Proc S D Acad Sci* 32:72-74.
- *Kaneko M, Natsuhori M, Ito N. 1999. Tissue concentration-time profile of selenium after sodium selenite administration to rats. *Int J PIXE* 9(3 & 4):315-323.
- *Kanematsu N, Hara M, Kada T. 1980. Reassay and mutagenicity studies on metal compounds. *Mutat Res* 77:109-116.
- Kardos J, Zimmer K, Coni E, et al. 1989. Determination of selenium in foods by inductively-coupled plasma atomic emission spectrometry and hydride generation. *Ann Ist Super Sanita* 25(3):505-509.
- Karlson U, Frankenberger WT, Jr. 1990. Volatilization of selenium from agricultural evaporation pond sediments. *Sci Total Environ* 92:41-54.
- Kasseroller R. 1998. Sodium selenite as prophylaxis against erysipelas in secondary lymphedema. *Anticancer Res* 18:2227-2230.
- Kato T, Read R, Rozga J, et al. 1992. Evidence for intestinal release of absorbed selenium in a form with high hepatic extraction. *Am J Physiol* 262(5Pt1):G854-858.

9. REFERENCES

- Kauf E, Dawczynski H, Jahreis G, et al. 1994. Sodium selenite therapy and thyroid-hormone status in cystic fibrosis and congenital hypothyroidism. *Biol Trace Elem Res* 40:247-253.
- *Kaur R, Parshad VR. 1994. Effects of dietary selenium on differentiation, morphology and functions of spermatozoa of the house rat, *Rattus rattus* L. *Mutat Res* 309:29-35.
- *Kautiainen A, Tornqvist M, Olsson U. 2000. Effects of selenium deficiency on the formation and detoxification of endogenous electrophiles in rats. *J Nutr Biochem* 11:425-430.
- *KDRG. 1979a. Observations on the effect of sodium selenite in the prevention of Keshan disease. Keshan Disease Research Group of the Chinese Academy of Medical Sciences. *Chin Med J [Engl]* 92:471-476.
- *KDRG. 1979b. Epidemiological studies on the etiological relationship of selenium and Keshan disease. Keshan Disease Research Group of the Chinese Academy of Medical Sciences. *Chin Med J [Engl]* 92:477-482.
- *Khalil AM. 1989. The induction of chromosome aberrations in human purified peripheral blood lymphocytes following *in vitro* exposure to selenium. *Mutat Res* 224(4):503-506.
- *Khalil AM. 1994. Genotoxicity of two pharmacologically important selenium compounds (selenocystine and selenopuridine) in cultured human blood lymphocytes. *Toxicol Environ Chem* 41:147-154.
- *Khan MY, Gilani SH. 1980. Selenium poisoning and embryogenesis: Light and electron microscopic studies of the heart. *Environ Res* 23:98-109.
- Kilburn KH, Warshaw RH. 1995. Neurotoxic effects from residential exposure to chemicals from and oil reprocessing facility and superfund site. *Neurotoxicol Teratol* 17(2):89-102.
- Kilness AW, Hochberg FH. 1977. Amyotrophic lateral sclerosis in a high selenium environment. *JAMA* 237:2843-2844.
- Kim BS, Margolin BH. 1999. Prediction of rodent carcinogenicity utilizing a battery of *in vitro* and *in vivo* genotoxicity tests. *Environ Mol Mutagen* 34:297-304.
- Kim HY, Picciano MF, Wallig MA, et al. 1991. The role of selenium nutrition in the development of neonatal rat lung. *Pediatr Res* 29(5):440-445.
- Kim IY, Stadtman TC. 1997. Inhibition of NF- κ B DNA binding and nitric oxide induction in human T cells and lung adenocarcinoma cells by selenite treatment. *Proc Natl Acad Sci USA* 94:12904-12907.
- Kinder DS, Colestock CN, Razniak SL, et al. 1988. Time-dependent distribution of sodium selenite in the female ICR mouse. *Bull Environ Contam Toxicol* 40(3):425-432.
- *Kinnigkeit G. 1962. [Investigation of workers exposed to selenium, in a factory producing rectifiers [Abstract]]. *Bull Hyg (London)* 37:1029-1030. (German).
- *Kiremidjian-Schumacher L, Roy M, Wishe HI, et al. 1992. Regulation of cellular immune responses by selenium. *Biol Trace Elem Res* 33:23-35.

9. REFERENCES

- *Kiremidjian-Schumacher L, Roy M, Wishe HI, et al. 1994. Supplementation with selenium and human immune cell functions. II. Effect of cytotoxic lymphocytes and natural killer cells. *Biol Trace Elem Res* 41:115-127.
- Kitahara J, Seko Y, Imura N. 1993. Possible involvement of active oxygen species in selenite toxicity in isolated rat hepatocytes. *Arch Toxicol* 67(7):497-501.
- Kivela SL, Maenpaa P, Nissinen A, et al. 1989. Vitamin A, vitamin E and selenium status in an aged Finnish male population. *Int J Vitam Nutr Res* 59(4):373-380.
- *Klaassen CD, Amdur MO, Doull JE, eds. 1986. Casarett and Doull's toxicology, the basic science of poisons. 3rd ed. New York, NY: Macmillan Publishing Company.
- *Knekt P, Heliovaara M, Rissanen A, et al. 1992. Serum antioxidant vitamins and risk of cataract. *Br Med J* 305(6866):1392-1394.
- Kobayashi R, Ohno H, Jindo T, et al. 1997a. Fifty-two-week oral repeated dose toxicity study in rats with ebselen. *Yakuri to Chiryō* 25(Suppl.):41-58.
- Kobayashi R, Ohno H, Tsuchihya T, et al. 1997b. Fifty-two-week oral repeated dose toxicity study in miniature pigs with ebselen. *Yakuri to Chiryō* 25(Suppl.):59-70.
- *Kobayashi Y, Ogra Y, Ishiwata K, et al. 2002. Selenosugars are key and urinary metabolites for selenium excretion within the required to low-toxic range. *Proc Natl Acad Sci U S A* 99(25):15932-15936.
- *Koh TS, Benson TH. 1983. Critical re-appraisal of fluorometric method for determination of selenium in biological materials. *J Assoc Off Anal Chem* 66:918-926.
- *Köhrle J. 1994. Thyroid hormone deiodination in target tissues - a regulatory role for the trace element selenium? *Exp Clin Endocrinol* 102:63-89.
- *Koirtyohann SR, Morris JS. 1986. General review of analytical methods. Some metals: As, Be, Cd, Cr, Ni, Pb, Se, Zn. Vol. 8. *IARC Sci Publ* 71:159-190.
- Kok FJ, Hofman A. 1989. Selenium status and cardiovascular disease: Dutch epidemiologica data. In: Wendel A, ed. *Selenium in biology and medicine*. New York, NY: Springer-Verlag, 214-218.
- Kok FJ, DeBruijn AM, Hofman A, et al. 1987a. Selenium status and chronic disease mortality: Dutch epidemiological findings. *Int J Epidemiol* 16:329-332.
- Kok FJ, DeBruijn AM, Hofman A, et al. 1987b. Is serum selenium a risk factor for cancer in men only? *Am J Epidemiol* 125:12-16.
- Kok FJ, DeBruijn AM, Hofman A, et al. 1987c. Serum selenium vitamin antioxidants, and cardiovascular mortality: A 9-year follow-up study in the Netherlands. *Am J Clin Nutr* 45:462-468.
- Koller LD, Exon JH. 1986. The two faces of selenium--deficiency and toxicity--are similar in animals and man. *Can J Vet Res* 50:297-306.

9. REFERENCES

- *Koller LD, Exon JH, Talcott PA, et al. 1986. Immune responses in rats supplemented with selenium. *Clin Exp Immunol* 63:570-576.
- *Kolodziejczyk L, Put A, Grzela P. 2000. Liver morphology and histochemistry in rats resulting from ingestion of sodium selenite and sodium fluoride. *Fluoride* 33(1):6-16.
- *Komori M, Nishio K, Kitada M, et al. 1990. Fetus-specific expression of a form of cytochrome P-450 in human livers. *Biochemistry* 29:4430-4433.
- Komsta-Szumaska E, Reuhl KR, Miller DR. 1983. The effect of methylmercury on the distribution and excretion of selenium by the guinea pig. *Arch Toxicol* 54:303-310.
- *Koppel C, Baudisch H, Beyer K-H, et al. 1986. Fatal poisoning with selenium dioxide. *Clin Toxicol* 24:21-35.
- *Korpela H, Lovenia R, Yrjanheikki, et al. 1984. Selenium concentration in maternal and umbilical cord blood, placenta, and amniotic membranes. *Intl J Vitam Nutr Res* 54:257-261.
- Korte NE, Skopp J, Fuller WH, et al. 1976. Trace element movement in soils: Influence of soil physical and chemical properties. *Soil Science* 122:350-359.
- Kosta L, Byrne AR, Zelenko V. 1975. Correlation between selenium and mercury in man following exposure to inorganic mercury. *Nature* 254:238-239.
- *Kramer GF, Ames BN. 1988. Mechanisms of mutagenicity and toxicity of sodium selenite (Na_2SeO_3) in *Salmonella typhimurium*. *Mutat Res* 201(1):169-180.
- Kraus T, Quidenus G, Schaller KH. 2000. Normal values for arsenic and selenium concentrations in human lung tissue. *Arch Environ Contam Toxicol* 38:384-389.
- *Kretz-Remy C, Arrigo A-P. 2001. Selenium: A key element that controls NF- κ B activation and IkB α half life. *Biofactors* 14:117-125.
- Krishnaja AP, Rege MS. 1982. Induction of chromosomal aberrations in fish *Boleophthalmus dussumieri* after exposure *in vivo* to mitomycin C and heavy metals mercury, selenium, and chromium. *Mutat Res* 102:71-82.
- Krishnamurti CR, Ramberg CF, Jr, Shariff MA. 1989. Kinetic modeling of selenium metabolism in nonpregnant ewes. *J Nutr* 119(8):1146-1155.
- *Krishnan K, Andersen ME. 1994. Physiologically based pharmacokinetic modeling in toxicology. In: Hayes AW, ed. *Principles and methods of toxicology*. 3rd ed. New York, NY: Raven Press, Ltd., 149-188.
- *Krishnan K, Andersen ME, Clewell HJ III, et al. 1994. Physiologically based pharmacokinetic modeling of chemical mixtures. In: Yang RSH, ed. *Toxicology of chemical mixtures: Case studies, mechanisms, and novel approaches*. San Diego, CA: Academic Press, 399-437.
- *Krynitsky AJ. 1987. Preparation of biological tissue for determination of arsenic and selenium. *Anal Chem* 59:1884-1886.

9. REFERENCES

- Kubota J, Allaway WH, Carter DL, et al. 1967. Selenium in crops in the United States in relation to selenium responsive diseases of animals. *J Agric Food Chem* 15:448-453.
- *Kubota J, Cary EE, Gissel-Nielsen G. 1975. Selenium in rainwater of the United States and Denmark. *Trace Subst Environ Health* 9:123-130.
- *Kuikka J, Nordman E. 1978. Measurement of ⁷⁵Se-sodium selenite in the human body. *Int J Nucl Med Biol* 5:30-34.
- *Kumar KSD, Kumar Shiva Prakash A, Swamy K, et al. 2002. Role of red blood cell selenium in recurrent pregnancy loss. *J Obstet Gynaecol* 22:181-183.
- *Kumpulainen J. 1983. Helsinki, Finland, personal communication. (As cited in Iyengar 1987).
- Kumpulainen J, Saarela KE. 1992. Determination of selenium in staple foods and total diets by electrothermal atomic absorption spectrometry without solvent extraction. *J Anal Atomic Spectr* 7(2):165-170.
- *Kumpusalo E, Karinpaa A, Jauhiainen M, et al. 1990. Multivitamin supplementation of adult omnivores and lactovegetarians: Circulating levels of vitamin A, D and E, lipids, apolipoproteins and selenium. *Int J Vitam Nutr Res* 60(1):58-66.
- Kyle R, Allen WM. 1990. Accidental selenium poisoning of a flock of sheep. *Vet Rec* 126(24):601.
- L'Abbe MR, Fischer PW, Chavez ER. 1989. Changes in selenium and antioxidant status during DMBA-induced mammary carcinogenesis in rats. *J Nutr* 119(5):766-771.
- Lacetera N, Bernabucci U, Ronchi B, et al. 1996. Effects of selenium and vitamin E administration during a late stage of pregnancy on colostrum and milk production in dairy cows, and on passive immunity and growth of their offspring. *Am J Vet Res* 57(12):1776-1780.
- Ladenstein R, Wendel A. 1983. The refined structure of the selenoenzyme glutathione peroxidase at 0.2-nm resolution. *Eur J Biochem* 133:51-69.
- Lafroth G, Ames BN. 1978. Mutagenicity of inorganic compounds in *Salmonella typhimurium*: Arsenic, chromium, and selenium. *Mutat Res* 53:65-66.
- Lakin HW. 1972. Selenium accumulation in soils and its absorption by plants and animals. *Geological Society of America Bulletin* 83:181-190.
- *Lakin HW, Davidson DF. 1967. The relation of the geochemistry of selenium to its occurrence in soils. In: Muth OH, ed. *Symposium: Selenium in biomedicine*. First International Symposium, Oregon State University. Westport, CT: AVI Publishing Co, 27-56.
- *Lalonde L, Jean Y, Roberts D, et al. 1982. Fluorometry of selenium in serum or urine. *Clin Chem* 28:172-174.

9. REFERENCES

- Lam RHF, Brown JP, Fan AM. 1994. Chemicals in California drinking water: Source of contamination, risk assessment, and drinking water standards. In: Wang RGM, ed. Water contamination and health: Integration of exposure assessment, toxicology, and risk assessment. New York, NY: Marcel Dekker, Inc., 15-44.
- Lamleung SY, Cheng VK, Lam YW. 1991. Application of a microwave oven for drying and nitric acid extraction of mercury and selenium from fish tissue. *Analyst* 116(9):957-959.
- Lane HW, Strength R, Johnson J, et al. 1991. Effect of chemical form of selenium on tissue glutathione peroxidase activity in developing rats. *J Nutr* 121(1):80-86.
- Lange JH. 1991. Reanalysis of epidemiological data for selenium anti-cancer activity. *Toxicol Ind Health* 7(4):319-325.
- Langenauer M, Kraehenbuehl U. 1991. Determination of selenium in food and minerals by neutron activation analysis. *Chimia* 45(1/2):8-10.
- Larner AJ. 1996. Alzheimer's disease, Kuf's disease, tellurium and selenium. *Med Hypotheses* 47:73-75.
- *Larsen NA, Pakkenberg H, Damsgaard E, et al. 1979. Topographical distribution of arsenic, manganese, and selenium in the normal human brain. *J Neurol Sci* 42:407-416.
- *Larsen PR, Davies TF, Hay ID. 1998. The thyroid gland. In: Wilson JD, Foster DW, Kronenberg HM, et al., eds. *Williams textbook of endocrinology*. Philadelphia, PA: W.B. Saunders Company, 390-515.
- Laszczyca P, Kawka-Serwecinska E, Dolezych B, et al. 1996. [The effects of cadmium poisoning and selenite gavage on amino acid metabolism in rats]. *Bromatol Chem Toksykol* 29(1):41-45. (Polish).
- *Lathrop KA, Johnston RE, Blau M, et al. 1972. Radiation dose to humans from ⁷⁵Se-L-selenomethionine. *J Nucl Med* 13:7-17.
- Lavi N, Alfassi ZB. 1990. Determination of trace amounts of cadmium, cobalt, chromium, iron, molybdenum, nickel, selenium, titanium, vanadium and zinc in blood and milk by neutron activation analysis. *Analyst* 115(6):817-822.
- Lavi N, Mantel M, Alfassi ZB. 1988. Determination of selenium in biological materials by neutron activation analysis. *Analyst* 113(12):1855-1859.
- LeBoeuf R, Laishes B, Hoekstra W. 1985. Effects of dietary selenium concentration on the development of enzyme-altered liver foci and hepatocellular carcinoma by diethylnitrosamine. *Cancer Res* 45:5489-5495.
- *Lee DS, Garland JA, Fox AA. 1994. Atmospheric concentrations of trace elements in urban areas of the United Kingdom. *Atmos Environ* 28(16):2691-2713.
- Lee M, Chan KK-S, Sairenji E, et al. 1979. Effect of sodium selenite on methylmercury-induced cleft palate in the mouse. *Environ Res* 19:39-48.
- *Lee M, Dong A, Yano J. 1969. Metabolism of ⁷⁵Se-selenite by human whole blood *in vitro*. *Can J Biochem* 47:791-797.

9. REFERENCES

- *Lee RE Jr, Duffield FV. 1979. Sources of environmentally important metals in the atmosphere. *Adv Chem Ser* 172:146-171.
- *Leeder JS, Kearns GL. 1997. Pharmacogenetics in pediatrics: Implications for practice. *Pediatr Clin North Am* 44(1):55-77.
- *Lemley AD. 1982. Response of juvenile centrachids to sublethal concentrations of waterborne selenium. I. Uptake, tissue distribution, and retention. *Aquatic Toxicology* 2:235-252.
- *Lemly AD. 1985. Toxicology of selenium in a freshwater reservoir: Implications for environmental hazard evaluation and safety. *Ecotoxicol Environ Safety* 10:314-338.
- Lemly AD. 1996. Evaluation of the hazard quotient method for risk assessment of selenium. *Ecotoxicol Environ Saf* 35:156-162.
- *Lemly AD. 1997. Ecosystem recovery following selenium contamination in a freshwater reservoir. *Ecotoxicol Environ Saf* 36:275-281.
- *Leung H-W. 1993. Physiologically-based pharmacokinetic modelling. In: Ballentine B, Marro T, Turner P, eds. *General and applied toxicology*. Vol. 1. New York, NY: Stockton Press, 153-164.
- *Levander OA. 1972. Metabolic interrelationships and adaptations in selenium toxicity. *Ann NY Acad Sci* 192:181-192.
- Levander OA. 1976. Selenium in foods. *Proceedings of the Symposium on Selenium-Tellurium in the Environment*. Pittsburgh, PA: Industrial Health Foundation, Inc., 26-53.
- *Levander OA. 1977. Metabolic interrelationships between arsenic and selenium. *Environ Health Perspect* 19:159-164.
- *Levander OA. 1982. Selenium: Biochemical actions, interactions, and some human health implications. In: *Clinical, biochemical, and nutritional aspects of trace elements*. New York, NY: Alan R. Liss, Inc., 345-368.
- *Levander OA. 1986. Selenium. In: Mertz W, ed. *Trace elements in human and animal nutrition*. Orlando, FL: Academic Press, Inc., 209-279.
- *Levander OA. 1987. A global view of human selenium nutrition. *Annu Rev Nutr* 7:227-250.
- Levander OA. 1989. Progress in establishing human nutritional requirements and dietary recommendations for selenium. In: Wendel A, ed. *Selenium in biology and medicine*. New York, NY: Springer-Verlag, 205-209.
- Levander OA. 1989. Upper limit of selenium in infant formulas. *J Nutr* 119: 1869-1873.
- Levander OA. 1991. Scientific rationale for the 1989 recommended dietary allowance for selenium. *J Am Diet Assoc* 91(12):1572-1576.
- *Levander OA, Baumann CA. 1966a. Selenium metabolism. V. Studies on the distribution of selenium in rats given arsenic. *Toxicol Appl Pharmacol* 9:98-105.

9. REFERENCES

- *Levander OA, Baumann CA. 1966b. Selenium metabolism. VI. Effect of arsenic on the excretion of selenium. *Toxicol Appl Pharmacol* 9:106-115.
- *Levander OA, Morris VC. 1970. Interactions of methionine, vitamin E, and antioxidants in selenium toxicity in the rat. *J Nutr* 100:1111-1118.
- Levander OA, Morris VC. 1984. Dietary selenium levels needed to maintain balance in North American adults consuming self-selected diets. *Am J Clin Nutr* 39:809-815.
- *Levander OA, Morris VC. 1985. What can balance studies tell us about human dietary selenium requirements? In: Mills CF, Bremner I, Chesters JK, eds. Trace elements in man and animals - TEMA - 5. Proceedings of the fifth international symposium on trace elements in man and animals. Commonwealth Agricultural Bureaux, 498-502.
- Levander OA, Whanger PD. 1996. Deliberations and evaluations of the approaches, endpoints and paradigms for selenium and iodine dietary recommendations. *J Nutr* 126(Suppl.):2427-2434.
- Levander OA, Bell JD, Morris VC, et al. 1991. Changes in urinary metabolite profiles in selenium intoxicated rats as revealed by proton nuclear magnetic resonance PNMR. *Am J Clin Nutr* 51(3):517.
- *Levander OA, Moser PB, Morris VC. 1987. Dietary selenium intake and selenium concentrations of plasma, erythrocytes, and breast milk in pregnant and postpartum lactating and nonlactating women. *Am J Clin Nutr* 46:694-698.
- Lewis LN. 1989. Preface. In: Tanji KK, Valoppi L, Woodring RC, eds. Selenium contents in animal and human food crops grown in California. CA: Cooperative Extension University of California, Division of Agriculture and Natural Resources. Publication 3330.
- *Lewis BG, Johnson CM, Broyer TC. 1971. Cleavage of Se-methylselenomethionine selenonium salt by cabbage leaf enzyme fraction. *Biochim Biophys Acta* 237:603-605.
- *Lewis SA. 1988. Determination of selenium in biological matrices. *Methods Enzymol* 158:391-402.
- *Lewis SA, Hardison NW, Veillon C. 1986. Comparison of isotope dilution mass spectrometry and graphite furnace atomic absorption spectrometry with Zeeman background correction for determination of plasma selenium. *Anal Chem* 58:1272-1273.
- *Li F, Rossipal E, Irgolic KJ. 1999. Determination of selenium in human milk by hydride cold-trapping atomic absorption spectrometry and calculation of daily selenium intake. *J Agric Food Chem* 47:3265-3268.
- *Li H, Shi-mei Z. 1994. Selenium supplementation in the prevention of pregnancy induced hypertension. *Chi Med J* 107(11):870-871.
- Li Y, Sun M, Wu D, et al. 1996. [Effects of single and combined action of selenium and arsenic on rat yolk-sac structure and function: An *in vitro* study]. *Wei Sheng Xen Chiu* 25(1):15-19. (Chinese).
- Li Y, Sun M, Wu D. 1997. [Effects of combined teratogenic action of selenium and arsenic on rat whole culture *in vitro*]. *Wei Sheng Xen Chiu* 16(2):32-34. (Chinese).

9. REFERENCES

- *Li Y, Sun W, Wu D, et al. 1999. [The toxicity of combination of selenium, fluoride and arsenic on rat embryos]. *Wei Sheng Xen Chiu* 28(2):74-75. (Chinese).
- *Lide DR. 1993. *CRC Handbook of chemistry and physics*. 74th ed. Boca Raton, FL: CRC Press Incorporated, 4-36.
- *Lide DR. 2000. *CRC handbook of chemistry and physics*. 81st ed. New York, NY: CRC Press, 4-27.
- *Lievens P, Versieck J, Cornelis R, et al. 1977. The distribution of trace elements in normal human liver determined by semi-automated radiochemical neutron activation analysis. *J Radioanal Chem* 37:483-496.
- *Lim JM, Hansel W. 1999. Exogenous substances affecting development of *in vitro*-derived bovine embryos before and after embryonic genome activation. *Theriogenology* 53(5):1081-1091.
- Lin WS, Scrimshaw C, Kapoor M. 1984. Selenium suppresses the metabolism of benzo[a]pyrene by rat-liver extracts, and exerts a dual effect on its mutagenicity. *Xenobiotica* 14:893-902.
- *Lindh U, Danersund A, Lindvall A. 1996. Selenium protection against toxicity from cadmium and mercury studied at the cellular level. *Cell Mol Biol* 42(1):39-48.
- Lisk DJ, Bache CA, Essick LA, et al. 1988. Absorption and excretion of selenium and barium in humans from consumption of brazil nuts. *Nutrition Reports International* 38(1):183-192.
- Litov RE, Combs GF, Jr. 1991. Selenium in pediatric nutrition. *Pediatrics* 87:339-351.
- Liu JZ, Milner JA. 1992. Age, dietary selenium and quantity of 7,12-dimethylbenz(a)anthracene influence the *in vivo* occurrence of rat mammary DNA adducts. *J Nutr* 122(7):1361-1368.
- Liu JZ, Gilbert K, Parker HM, et al. 1991. Inhibition of 7,12-dimethylbenz(a)anthracene-induced mammary tumors and DNA adducts by dietary selenite. *Cancer Res* 51(17):4613-4617.
- *Livingston AL. 1978. Forage plant estrogens. *J Toxicol Environ Health* 4:301-324.
- Llorente I, Gomez M, Camara C. 1997. Improvement of selenium determination in water by inductively coupled plasma mass spectrometry through use of organic compounds as matrix modifiers. *Spectrochimica Acta Part B* 52:1825-1838.
- *Lo LW, Koropatnick J, Stick HF. 1978. The mutagenicity and cytotoxicity of selenite, 'activated' selenite, and selenate for normal and DNA repair-deficient human fibroblasts. *Mutat Res* 49:305-312.
- Lo MT, Sandi E. 1980. Selenium: Occurrence in foods and its toxicological significance--a review. *J Environ Pathol Toxicol* 4(1):193-218.
- *Lobinski R, Edmonds JS, Suzuki KT, et al. 2000. Species-selective determination of selenium compounds in biological materials. *Pure Appl Chem* 72(3):447-461.
- *Lockitch G. 1989. Selenium: Clinical significance and analytical concepts. *Crit Rev Clin Lab Sci* 27(6):483-541.
- *Lofroth G, Ames BN. 1978. Mutagenicity of inorganic compounds in *Salmonella typhimurium*: Arsenic, chromium, and selenium. *Mutat Res* 53:65-66.

9. REFERENCES

- *Lombeck I, Menzel H, Frosch D. 1987. Acute selenium poisoning of a 2-year-old child. *Eur J Pediatr* 146(3):308-312.
- Long RH, Benson SM, Tokunaga TK, et al. 1990. Selenium immobilization in a pond sediment at Kesterson Reservoir. *J Environ Qual* 19(2):302-311.
- *Longnecker MP, Stampfer MJ, Morris JS, et al. 1993. A 1-y trial of the effect of high-selenium bread on selenium concentrations in blood and toenails. *Am J Clin Nutr* 57:408-413.
- *Longnecker MP, Taylor PR, Levander OA, et al. 1991. Selenium in diet, blood, and toenails in relation to human health in a seleniferous area. *Am J Clin Nutr* 53(5):1288-1294.
- Lopez-Molinero A, Gimenez R, Otal P, et al. 2002. New sensitive determination of selenium by bromide volatilization inductively coupled plasma atomic emission spectrometry. *J Anal Atom Spectrom* 17(4):352-357.
- *Lowe TP, May TW, Brumbaugh WG, et al. 1985. National contaminant biomonitoring program: Concentrations of seven elements in freshwater fish, 1978-1981. *Arch Environ Contam Toxicol* 14:363-388.
- Lowenthal DH, Rahn KA. 1989. Spatial patterns of non-urban selenium concentrations in the northeastern U.S. and its pollution source implications. *Comments. Atmos Environ* 23(7):1613-1614.
- Lowry KR, Baker DH. 1989. Amelioration of selenium toxicity by arsenicals and cysteine. *J Anim Sci* 67(4):959-965.
- Lu FC. 1998. Recent advances in studies on selenium: An overview of a symposium held in China. *Regul Toxicol Pharmacol* 27:204-206.
- Lu J, Jiang C, Kaeck M, et al. 1995a. Cellular and metabolic effects of triphenylselenonium chloride in a mammary cell culture model. *Carcinogenesis* 16(3):513-517.
- *Lu J, Jiang C, Kaeck M, et al. 1995b. Dissociation of the genotoxic and growth inhibitory effects of selenium. *Biochem Pharmacol* 50(2):213-219.
- *Luoma PV, Nayha S, Pyy L, et al. 1992. Blood mercury and serum selenium concentrations in reindeer herders in the arctic area of northern Finland. *Arch Toxicol Suppl* 15:172-175.
- *Ma J, Stampfer MJ, Morris JS, et al. 1995. Toenail selenium level and lung cancer among men and women in a high seleniferous region of the USA [Abstract]. *Am J Epidemiol* 141(10):S68.
- *Maag DD, Orsborn JS, Clopton JR. 1960. The effect of sodium selenite on cattle. *Am J Vet Res* 21:1049-1053.
- MacDonald DW, Christian RG, Strausz KI, et al. 1981. Acute selenium toxicity in neonatal calves. *Can Vet J* 22:279-281.
- Machat J, Kanicky V, Otruba V. 2002. Determination of selenium in blood serum by inductively coupled plasma atomic emission spectrometry with pneumatic nebulization. *Anal Bioanal Chem* 372(4):576-581.

9. REFERENCES

- *Mack RB. 1990. The fat lady enters stage left. Acute selenium poisoning. *N C Med J* 51(12):636-638.
- *Macpherson AK, Sampson B, Diplock AT. 1988. Comparison of methods for the determination of selenium in biological fluids. *Analyst* 113(2):281-283.
- Magos L. 1991. Overview on the protection given by selenium against mercurials. *Prov Rochester Int Conf Environ Toxic 2 Adv Mercury Toxicol.*, 289-298.
- *Magos L, Webb M. 1980. The interactions of selenium with cadmium and mercury. *CRC Crit Rev Toxicol* (Nov) 1980:1-42.
- *Magos L, Clarkson TW, Sparrow S, et al. 1987. Comparison of the protection given by selenite, selenomethionine and biological selenium against the neurotoxicity of mercury. *Arch Toxicol* 60:422-426.
- *Mahan DC, Kim YY. 1996. Effect of inorganic or organic selenium at two dietary levels on reproductive performance and tissue selenium concentrations in first-parity gilts and their progeny. *J Anim Sci* 74:2711-2718.
- *Mahan DC, Magee PL. 1991. Efficacy of dietary sodium selenite and calcium selenite provided in the diet at approved, marginally toxic, and toxic levels to growing swine. *J Anim Sci* 69(12):4722-4725.
- *Maier KJ, Foe C, Ogle RS, et al. 1988. The dynamics of selenium in aquatic ecosystems. In: Hemphill DD, ed. *Trace substances in environmental health. XXI Proceedings.* Columbia, MO: University of Missouri, 361-408.
- Maier KJ, Nelson CR, Bailey FC, et al. 1998. Accumulation of selenium by the aquatic biota of a watershed treated with seleniferous fertilizer. *Bull Environ Contam Toxicol* 60:409-416.
- Maier KJ, Ogle RS, Maier KR, et al. 1989. Determination of the toxicity, water quality interactions and biomagnification of selenium in aquatic food chains. U.S. Geological Survey Report. ISS USGS/G-1495. 128 NTIS/PB90-132648.
- Maquat LE. 2001. Evidence that selenium deficiency results in the cytoplasmic decay of GPx1 mRNA dependent on pre-mRNA splicing proteins bound to the mRNA exon-exon junction. *Biofactors* 14:37-52.
- *Mannan S, Picciano MF. 1987. Influence of maternal selenium status on human milk selenium concentration and glutathione peroxidase activity. *Am J Clin Nutr* 46:95-100.
- Marano G, Spagnolo A, Morisi G, et al. 1991. Changes of serum selenium and serum cholesterol in children during sexual maturation. *J Trace Elem Electrolytes Health Dis* 5(1):59-61.
- Marin-Guzman J, Mahan DC, Pate JL. 2000. Effect of dietary selenium and vitamin E on spermatogenic development in boars. *J Anim Sci* 78:1537-1543.
- Marin-Guzman J, Mahan DC, Whitmoyer R. 2000. Effect of dietary selenium and vitamin E on the ultrastructure and ATP concentration of boar spermatozoa, and the efficacy of added sodium selenite in extended semen on sperm motility. *J Anim Sci* 78:1544-1550.
- Marsh DO, Turner MD, Smith JC, et al. 1995. Fetal methylmercury study in a Peruvian fish-eating population. *Neurotoxicology* 16(4):717-726.

9. REFERENCES

Marshall MV, Arnott MS, Jacobs MM, et al. 1979. Selenium effects on the carcinogenicity and metabolism of 2-acetyl aminofluorene. *Cancer Letters* 7:331-338.

*Martin BJ, Lyon TD, Fell GS. 1991. Comparison of inorganic elements from autopsy tissue of young and elderly subjects. *J Trace Elem Electrolytes Health Dis* 5(3):203-211.

Martin RF, Janghorbani M, Young VR. 1988. Kinetics of a single administration of ⁷⁴Se-selenite by oral and intravenous routes in adult humans. *JPEN J Parenter Enteral Nutr* 12(4):351-355.

*Martin RF, Janghorbani M, Young VR. 1989a. Experimental selenium restriction in healthy adult humans: Changes in selenium metabolism studied with stable-isotope methodology. *Am J Clin Nutr* 49(5):854-861.

*Martin RF, Young VR, Blumberg J, et al. 1989b. Ascorbic acid-selenite interactions in humans studied with an oral dose of ⁷⁴SeO₃(2-). *Am J Clin Nutr* 49(5):862-869.

Maryland HF. 1994. Selenium in plant and animal nutrition. In: Frankenburger WT, Benson S, eds. *Selenium in the Environment*. New York, NY: Marcel Dekker Inc., 29-45.

*Mas A, Sarkar B. 1989. Role of glutathione in selenite binding by human plasma. *Biol Trace Elem Res* 20(1-2):95-104.

Mas A, Jiang JY, Sarkar B. 1988. Selenite metabolism in rat and human blood. *Biol Trace Elem Res* 15:97-110.

*Mason KE, Young JO. 1967. Effectiveness of selenium and zinc in protecting against cadmium-induced injury of the rat testis. In: O.H. Muth, ed. *Symposium: Selenium in biomedicine*. Westport, CT: AVI Publishing Co., Inc., 383-394.

Massacheleyn PH, Delaune RD, Patrick JW. 1991. Selenium speciation in aqueous solutions using a hydride generation atomic absorption spectrophotometry technique. *Spectr Lett* 24:307-322.

Masumoto H, Nakaoka M, Tsutsumi S, et al. 1997. [Pharmacokinetics of ebselen in rats: Absorption, distribution and excretion after administration of ⁷⁵Se-labelled compound]. *Yakubutsu Dotai* 12(6):619-629. (Japanese).

Matoba R, Kimura H, Uchima E, et al. 1986. An autopsy case of acute selenium (selenious acid) poisoning and selenium levels in human tissues. *Forensic Sci Int* 31:87-92.

Matsumura H, Takahata R, Hayaishi O. 1991. Inhibition of sleep in rats by inorganic selenium compounds, inhibitors of prostaglandins D synthase. *Proc Natl Acad Sci USA* 88(20):9046-9050.

Maxuitenko YY, Libby AH, Joyner HH, et al. 1998. Identification of dithiolethiones with better chemopreventive properties than oltipraz. *Carcinogenesis* 19(9):1609-1615.

May SW. 1999. Selenium-based drug design: Rationale and therapeutic potential. *Exp Opin Invest Drugs* 8(7):1017-1030.

May SW, Pollock SH. 1998. Selenium-based antihypertensives: Rationale and potential. *Drugs* 56(6):959-964.

9. REFERENCES

- May SW, Wang L, Gill-Woznichak MM, et al. 1997. An orally active selenium-based antihypertensive agent with restricted CNS permeability. *J Pharmacol Exp Ther* 283(2):470-477.
- *May TW, McKinney GL. 1981. Cadmium, lead, mercury, arsenic, and selenium concentrations in freshwater fish, 1976-1977 National Pesticide Monitoring Program. *Pestic Monit J* 15:14-38.
- Mayer D, Haubenwallner S, Kosmus W, et al. 1992. Modified electrical heating system for hydride generation atomic absorption spectrometry and elaboration of a digestion method for the determination of arsenic and selenium in biological materials. *Anal Chim Acta* 268(2):315-321.
- *Mayr U, Butsch A, Schneider S. 1992. Validation of two *in vitro* test systems for estrogenic activities with zearalenone, phytoestrogens and cereal extracts. *Toxicology* 74:135-149.
- *McCarthy TP, Brodie B, Milner JA, et al. 1981. Improved method for selenium determination in biological samples by gas chromatography. *J Chromatogr* 225:9-16.
- *McConnell KP, Broghamer WL, Jr., Blotcky AJ, et al. 1975. Selenium levels in human blood and tissues in health and disease. *J Nutr* 105:1026-1031.
- *McConnell KP, Roth DM. 1966. Respiratory excretion of selenium. *Proc Soc Exp Biol Med* 123:919-921.
- McConnell KP, Jager RM, Bland KI, et al. 1980. The relationship of dietary selenium and breast cancer. *J Surg Oncol* 15:67-70.
- McGahan MC, Grimes AM. 1991. Selenium concentration in ocular tissues and fluids. *Ophthalmic Res* 23(1):45-50.
- McLaughlin K, Dadgar D, Smyth MR, et al. 1990. Determination of selenium in blood plasma and serum by flow injection hydride generation atomic absorption spectrometry. *Analyst* 115(3):275-278.
- McMaster D, Bell N, Anderson P, et al. 1990. Automated measurement of two indicators of human selenium status, and applicability to population studies. *Clin Chem* 36(2):211-216.
- *McNeill JH, Delgatty HL, Battell ML. 1991. Insulinlike effects of sodium selenate in streptozocin-induced diabetic rats. *Diabetes* 40(12):1675-1678.
- Meador JP, Ernest D, Hohn AA, et al. 1999. Comparison of elements in bottlenose dolphins stranded on the beaches of Texas and Florida in the Gulf of Mexico over a one-year period. *Arch Environ Contam Toxicol* 36:87-98.
- Medina D. 1986. Mechanisms of selenium inhibition of tumorigenesis. *Adv Exp Med Biol* 206:465-472.
- *Medina D, Shepherd F. 1981. Selenium-mediated inhibition of 7,12-dimethylbenz[a]anthracene-induced mouse mammary tumorigenesis. *Carcinogenesis* 2:451-455.
- *Medinsky MA, Cuddihy RG, Griffith WC, et al. 1981a. A simulation model describing the metabolism of inhaled and ingested selenium compounds. *Toxicol Appl Pharmacol* 59:54-63.

9. REFERENCES

- *Medinsky MA, Cuddihy RG, McClellan RO. 1981b. Systemic absorption of selenious acid and elemental selenium aerosols in rats. *J Toxicol Environ Health* 8:917-928.
- Medinsky MA, Cuddihy RG, Hill JO, et al. 1981c. Toxicity of selenium compounds to alveolar macrophages. *Toxicol Lett* 8:298-293.
- *Meltzer HM, Norheim G, Bibow K, et al. 1990. The form of selenium determines the response to supplementation in a selenium replete population. *Eur J Clin Nutr* 44(6):435-446.
- *Meltzer HM, Norheim G, Loken EB, et al. 1992. Supplementation with wheat selenium induces a dose-dependent response in serum and urine of a Se-replete population. *Br J Nutr* 67(2):287-294.
- *Menkes M, Comstock G, Vuilleumier J, et al. 1986. Serum beta-carotene, vitamins A and E, selenium, and the risk of lung cancer. *N Engl J Med* 315:1250-1254.
- Menter DG, Sabichi AL, Lippman SM. 2000. Selenium effects on prostate cell growth. *Cancer Epidemiol Biomarkers Prev* 9:1171-1182.
- Merrick BA, Johnson KL, Kester KA, et al. 1983. Species and sex differences in selenium inhibition of hepatic drug metabolism in rodents. *Drug Chem Toxicol* 6:329-340.
- Methenitou G, Maravelias C, Koutsogeorgopoulou L, et al. 1996. Immunomodulative effects of aflatoxins and selenium on human peripheral blood lymphocytes. *Vet Hum Toxicol* 38(4):274-277.
- Meydani M, Maccauley JB, Blumberg JB. 1986. Influence of dietary vitamin E, selenium and age on regional distribution. *Lipids* 21:786-791.
- *Meyer F, Vereault R. 1987. Erythrocyte selenium and breast cancer risk. *Am J Epidemiol* 125:376-383.
- *Michalke B, Schramel P. 1998. Selenium speciation in human milk with special respect to quality control. *Biol Trace Elem Res* 59:45-56.
- Michelot D, Poirier F, Melendez-Howell LM. 1999. Metal content profiles in mushrooms collected in primary forests of Latin America. *Arch Environ Contam Toxicol* 36:256-263.
- Michelson AM. 1998. Selenium glutathione peroxidase: Some aspects in man. *J Environ Pathol Toxicol Oncol* 17(3&4):233-239.
- *Michot TC, Custer TW, Nault AJ, et al. 1994. Environmental contaminants in redheads wintering in coastal Louisiana and Texas. *Arch Environ Contam Toxicol* 26:425-434.
- *Middleton JM. 1947. Selenium burn of the eye. Review of a case with review of the literature. *Arch Ophthalmol* 38:806-811.
- *Mihailovic M, Matic G, Lindberg P, et al. 1992. Accidental selenium poisoning of growing pigs. *Biol Trace Elem Res* 33:63-69.
- *Miller WT, Williams KT. 1940. Minimum lethal dose of selenium as sodium selenite for horses, mules, cattle and swine. *Journal of Agricultural Research* 60:163-173.

9. REFERENCES

- Milner JA. 1995. Selenium: Do we dare neglect it? In: Bronner F, ed. Nutrition and health: Topics and controversies. New York, NY: CRC Press, 200-227.
- *Minoia C, Sabbioni E, Apostoli P, et al. 1990. Trace element reference values in tissue from inhabitants of the European community I. A study of 46 elements in urine, blood, and serum of Italian subjects. *Sci Total Environ* 95:89-105.
- Mirsalis JC, Tyson CK, Steinmetz KL, et al. 1989. Measurement of unscheduled DNA synthesis and S-phase synthesis in rodent hepatocytes following *in vivo* treatment: Testing of 24 compounds. *Environ Mol Mutagen* 14(3):155-164.
- *Mofenson HC, Caraccio TR. 1998. Toxicity of household products. In: Viccellio P, ed. Emergency toxicology. 2nd ed. Philadelphia, PA: Lippincott-Raven, 519.
- *Mohammed HO, White ME, Guard CL, et al. 1991. A case control study of the association between blood selenium and cystic ovaries in lactating dairy cattle. *J Dairy Sci* 74(7):2180-2185.
- *Molokhia A, Portnoy B, Dyer A. 1979. Neutron activation analysis of trace elements in skin. *Br J Dermatol* 101:567-572.
- Money DFL. 1970. Vitamin E and selenium deficiencies and their possible etiological role in the sudden death in infants syndrome. *N Z Med J* 71:32-34.
- Moore FR, Samoy J, Montieth D, et al. 1996a. Selective acute toxicity and DNA strand breakage of selenium sulfide to rat liver [Abstract]. *Environ Mol Mutagen* 27(Suppl. 27):49.
- Moore FR, Urda GA, Krishna G, et al. 1995. Genotoxicity evaluation of selenium sulfide in rats. *Environ Mol Mutagen* 25(Suppl. 25):36.
- *Moore FR, Urda GA, Krishna G, et al. 1996b. Genotoxicity evaluation of selenium sulfide *in vivo* and *in vivo/in vitro* micronucleus and chromosome aberration assays. *Mutat Res* 367:33-41.
- Mora MA. 1996. Organochlorines and trace elements in four colonial waterbird species nesting in the lower Laguna Madre, Texas. *Arch Environ Contam Toxicol* 31:533-537.
- Mora MA, Wainwright SE. 1998. DDE, mercury, and selenium in biota, sediments, and water of the Rio Grande-Rio Bravo Basin, 1965-1995. *Rev Environ Contam Toxicol* 158:1-52.
- Moreno MA, Marin C, Vinagre F, et al. 1999. Trace element levels in whole blood samples from residents of the city Badajoz, Spain. *Sci Total Environ* 229:209-215.
- Morgan DL, Shines CJ, Jeter SP, et al. 1995. Acute pulmonary toxicity of copper gallium diselenide, copper indium diselenide, and cadmium telluride intratracheally instilled into rats. *Environ Res* 71:16-24.
- Morgan DL, Shines CJ, Jeter SP, et al. 1997. Comparative pulmonary absorption, distribution, and toxicity of copper gallium diselenide, copper indium diselenide, and cadmium telluride in Sprague-Dawley rats. *Toxicol Appl Pharmacol* 147:399-410.
- *Morisi G, Patriarca M, Marano G, et al. 1989. Age and sex specific reference serum selenium levels estimated for the Italian population. *Ann Ist Super Sanita* 25(3):393-403.

9. REFERENCES

- Morris JG. 1988. The bioavailability of selenium in animal foods. In: Tanji KK, Valoppi L, Woodring RC, eds. Selenium contents in animal and human food crops grown in California. Cooperative Extension University of California, Division of Agriculture and Natural Resources. Publication 3330, 89-96.
- *Morris VC, Levander OA. 1970. Selenium content of foods. *J Nutr* 100:1383.
- Morrow DA. 1968. Acute selenite toxicosis in lambs. *J Am Vet Med Assoc* 152:1625-1629.
- *Morselli PL, Franco-Morselli R, Bossi L. 1980. Clinical pharmacokinetics in newborns and infants: Age-related differences and therapeutic implications. *Clin Pharmacokin* 5:485-527.
- *Moser-Veillon PB, Mangels AR, Patterson KY, et al. 1992. Utilization of two different chemical forms of selenium during lactation using stable isotope tracers: An example of speciation in nutrition. *Analyst* 117(3):559-562.
- Moxon AL. 1938. The effect of arsenic on the toxicity of seleniferous grains. *Science* 88:81.
- *Moxon AL, DuBois KP. 1939. The influence of arsenic and certain other elements on the toxicity of seleniferous grains. *J Nutr* 18:447-457.
- Moxon AL, Rhian M. 1943. Selenium poisoning. *Physiol Rev* 23:305-337.
- Moxon AL, Olson OE, Searight WV. 1939. Selenium in rocks, soils, and plants. South Dakota Agricultural Experimental Station Technical Bulletin No. 2:94.
- *Moxon AL, Paynter CR, Halverson AW. 1945. Effect of route of administration on detoxication of selenium by arsenic. *J Pharmacol Exp Ther* 84:115-119.
- *Moyad MA. 2002. Selenium and vitamin E supplements for prostate cancer: Evidence or embellishment? *Urology* 59:9-19.
- Mozier NM, McConnell KP, Hoffman JL. 1988. S-Adenosyl-L-methionine: thioether S-methyltransferase, a new enzyme in sulfur and selenium metabolism. *J Biol Chem* 263:4527-4531.
- *Muñoz Olivas R, Donard OFX, Cámara C, et al. 1994. Analytical techniques applied to the speciation of selenium in environmental matrices. *Analytic Chimica Acta* 286:357-370.
- Muntau AC, Streiter M, Kappler M, et al. 2002. Age-related reference values for serum selenium concentrations in infants and children. *Clin Chem* 48(3):555-560.
- *Muramatsu Y, Parr RM. 1988. Concentrations of some trace elements in hair, liver and kidney from autopsy subjects: relationship between hair and internal organs. *Sci Total Environ* 76:29-40.
- Mussalo-Rauhamaa H, Vuori E, Lehto JJ. 1993. Increase in serum levels in Finnish children and young adults during 1980-1986: A correlation between the serum levels and the estimated intake. *Eur J Clin Nutr* 47:711-717.
- Mutanen M, Aspila P, Mykkanen HM. 1986. Bioavailability to rats of selenium in milk of cows fed sodium selenite or selenited barley. *Ann Nutr Metab* 30:183-188.

9. REFERENCES

- Mutanen M, Koivistoinen P, Morris VC, et al. 1987. Relative nutritional availability to rats of selenium in Finnish spring wheat (*Triticum aestivum* L.) fertilized or sprayed with sodium selenate and in an American winter bread wheat naturally high in Se. *Br J Nutr* 57:319-329.
- Mutanen M, Viita L, Mykkanen HM. 1989. Selenium supplementation does not alter platelet activation in subjects with normal selenium status. *Int J Vitam Nutr Res* 59(3):309-313.
- Muth OH, Oldfield JE, Remmert LF, et al. 1958. Effects of selenium and vitamin E on white muscle disease. *Science* 128:1090.
- Muth OH, Oldfield JE, Schubert JR, et al. 1959. White muscle disease (myopathy) in lambs and calves. VI. Effects of selenium and vitamin E on lambs. *Am J Vet Res* 20:231-234.
- *Nadig RJ. 1994. Cadmium and other metals and metalloids. In: Goldfrank LR, Weisman RS, Flomenbaum N, et al. Eds. *Goldfrank's toxicological emergencies*. 6th ed. Norwalk, CT: Apleton and Lange, 1342-1343.
- Naganuma A, Imura N. 1981. Properties of mercury and selenium in a high molecular weight substance in rabbit tissues formed by simultaneous administration. *Pharmacol Biochem Behav* 15:449-454.
- *Naganuma A, Tanaka T, Kyoko M, et al. 1983. The interaction of selenium with various metals *in vitro* and *in vivo*. *Toxicology* 29:77-86.
- Nakamuro K, Jyotatsu Y, Okuno T, et al. 1996. [Behavior of methylated metabolites of selenium in rats orally administered with various dose levels of sodium selenite]. *Jpn J Toxicol Environ Health (Eisei Kagaku)* 42(4):340-347. (Japanese).
- Nakamuro K, Nakanishi K, Okuno T, et al. 1997. [Comparison of methylated selenium metabolites in rats after oral administration of various selenium compounds]. *Jpn J Toxicol Environ Health (Eisei Kagaku)* 43(3):182-189. (Japanese).
- *Nakamuro K, Okuno T, Hasegawa T. 2000. Metabolism of selenoamino acids and contribution of selenium methylation to their toxicity. *J Health Sci* 46(6):418-421.
- *Nakamuro K, Sayato Y, Ose Y. 1977. Studies on selenium-related compounds. VI. Biosynthesis of dimethylselenide in rat liver after oral administration of sodium selenate. *Toxicol Appl Pharmacol* 39:521-529.
- *Nakamuro K, Yoshikawa Y, Sayato Y, et al. 1976. Studies on selenium-related compounds. V. Cytogenetic effect and reactivity with DNA. *Mutat Res* 40:177-184.
- *Narasaski H. 1985. Determination of arsenic and selenium in fat materials and petroleum products by oxygen bomb combustion and automated atomic absorption spectrometry with hydride generation. *Anal Chem* 57:2481-2486.
- *NAS. 1976a. Selenium. *Comm Med Biol Effects Environ Pollut Subcomm - Selenium*. Washington, DC: National Academy of Sciences.
- *NAS. 1976b. Drinking water and health. Washington, DC: National Academy of Sciences.
- NAS. 1977. Drinking water and health. Washington, DC: National Academy of Sciences, 344-368.

9. REFERENCES

- NAS. 1980a. Recommended dietary allowances. 9th Rev. Natl. Res. Council. Washington, DC: Food and Nutrition Board, National Academy of Science, 162-164.
- *NAS. 1980b. Drinking water and health. Washington, DC: National Academy of Sciences, 326-344.
- NAS. 1983. Nutrient requirements of laboratory animals. 15th ed. Washington, DC: National Academy of Sciences.
- *NAS. 2000. Selenium. In: Dietary reference intakes for vitamin C, vitamin E, selenium, and carotenoids. Washington, DC: National Academy of Sciences, National Academy Press, 284-324.
- *NAS/NRC. 1989. Report of the oversight committee. In: Biologic markers in reproductive toxicology. Washington, DC: National Academy of Sciences, National Research Council, National Academy Press.
- NATICH. 1992. Report of Federal, State and Local Air Toxics Activities. Research Triangle Park, NC: National Air Toxics Information Clearinghouse, U.S. Environmental Protection Agency.
- Navarro M, López H, Pérez V, et al. 1996. Serum selenium levels during normal pregnancy in healthy Spanish women. *Sci Total Environ* 186:237-242.
- Navarro-Alarcón M, López-Martínez MC. 2000. Essentiality of selenium in the human body: Relationship with different diseases. *Sci Total Environ* 249:347-371.
- Navarro-Alarcón M, López-G de la Serrana H, Pérez-Valero V, et al. 1999. Serum and urine selenium concentrations as indicators of body status in patients with diabetes mellitus. *Sci Total Environ* 228:79-85.
- *NCDNR. 1986. North Carolina water quality standards documentation: The freshwater chemistry and toxicity of selenium with an emphasis on its effects in North Carolina. North Carolina Department of Natural Resources and Community Development Division of Environmental Management, Water Quality Section. Water Quality Technical Reports. Report No. 86-02.
- *NCI. 1968. Evaluation of carcinogenic, teratogenic, and mutagenic activities of selected pesticides and industrial chemicals. Volume I. Carcinogenic study. Bethesda, Maryland: National Cancer Institute. PB 233 159.
- Neal RH, Sposito G. 1991. Selenium mobility in irrigated soil columns as affected by organic carbon amendment. *J Environ Qual* 20:808-814.
- Nebbia C, Gremmels JF, Soffiatti MG. 1990. Pathogenesis of sodium selenite and dimethylselenide acute toxicosis in swine: Tissue and blood biochemical changes. *Res Commun Chem Pathol Pharmacol* 67(1):117-130.
- Nebbia C, Soffiatti MG, Zittlau E, et al. 1991. Pathogenesis of sodium selenite and dimethylselenide acute toxicosis in pigs: Cardiovascular changes. *Res Vet Sci* 50(3):269-272.
- Negretti de Bratter VE, Bratter P, Tomiak A. 1990. An automated microtechnique for selenium determination in human body fluids by flow injection hydride atomic absorption spectrometry (FI-HAAS). *J Trace Elem Electrolytes Health Dis* 4(1):41-48.

9. REFERENCES

- *Nehru LB, Bansal MP. 1996. Effect of selenium supplementation on the glutathione redox system in the kidney of mice after chronic cadmium exposures. *J Appl Toxicol* 17(1):81-84.
- *Nelp WB, Blumberg F. 1965. A comparison of the selenate and sulfate ions in man and dog. *J Nucl Med* 6:822-830.
- *Nelson AA, Fitzhugh OG, Calvery HO. 1943. Liver tumors following cirrhosis caused by selenium in rats. *Cancer Res* 3:230-236.
- *Neumann PB, Coffindaffer TW, Cothran PE, et al. 1996. Clinical investigation comparing 1% selenium sulfide and 2% ketoconazole shampoos for dandruff control. *Cosmet Dermatol* 9(12):20-26.
- Nève J. 1996. Selenium as a risk factor for cardiovascular diseases. *J Cardiovasc Risk* 3:42-47.
- Nève J. 2000. New approaches to assess selenium status and requirement. *Nutr Rev* 58(12):363-369.
- *Nève J, Vertongen F, Capel P. 1988. Selenium supplementation in healthy Belgian adults: Response in platelet glutathione peroxidase activity and other blood indices. *Am J Clin Nutr* 48:139-143.
- Nève J, Vertongen F, Thonnart N, et al. 1986. Selenium supplementation during parenteral and enteral nutrition, short- and long-term effects of two derivatives. *Acta Pharmacol Toxicol (Copenh)* 59:142-145.
- Newton MF, Lilly IJ. 1984. The clastogenicity of chromium and selenium compounds to rat tissues. *Heredity (Edinburgh)* 53:564-565.
- *Newton MF, Lilly LL. 1986. Tissue-specific clastogenic effects of chromium and selenium salts *in vivo*. *Mutat Res* 169:61-69.
- Nielson JB, Anderson O. 1991. A comparison of the effects of sodium selenite and seleno-L-methionine on disposition of orally administered mercuric chloride. *J Trace Elem Electrolytes Health Dis* 5(4):245-250.
- *Nielsen J, Andersen O. 1995. A comparison of the lactational and transplacental deposition of mercury in offspring from methylmercury-exposed mice. Effect of seleno-L-methionine. *Toxicol Lett* 76:165-171.
- *NIOSH. 1983. National occupational exposure survey (NOES). Cincinnati, OH: National Occupational Safety and Health.
- *NIOSH. 1989. National occupational exposure survey. Cincinnati, OH: National Occupational Safety and Health.
- NIOSH. 1992a. NIOSH/OSHA Pocket Guide To Chemical Hazards. National Institute for Occupational Safety and Health, Department of Health and Human Services, 206.
- NIOSH. 1992b. Recommendations for occupational safety and health. National Institute for Occupational Safety and Health, Department of Health and Human Services.
- *NIOSH. 1994a. NIOSH manual of analytical methods. Method 7300. Cincinnati, OH: National Institute for Occupational Safety and Health, Department of Health and Human Services, Division of Physical Sciences and Engineering.

9. REFERENCES

- NIOSH. 1994b. Documentation for immediately dangerous to life or health concentrations (IDLHS). Cincinnati, OH: National Institute for Occupational Safety and Health. PB94195047.
- *NIOSH. 2001. International chemical safety cards. National Institute for Occupational Safety and Health. <http://www.cdc.gov/niosh/nioshsrch.html>. February 22, 2001.
- Nishikido N, Suzuki T. 1985. Effects of gestational stage and injection route on the corporeal distribution and placental transfer of selenium in pregnant mice. *Ind Health* 23:95-106.
- *Nishikido N, Furuyashiki K, Naganuma A, et al. 1987. Maternal selenium deficiency enhances the fetolethal toxicity of methyl mercury. *Toxicol Appl Pharmacol* 88:322-328.
- NLFCA. 1995. National Listing of Fish Consumption Advisories. U.S. EPA database.
- Noack-Fuller G, DeBeer C, Seibert H. 1993. Cadmium, lead, selenium, and zinc in semen of occupationally unexposed men. *Andrologia* 25(1):7-12.
- *Nobunaga T, Satoh H, Suzuki T. 1979. Effects of sodium selenite on methylmercury embryotoxicity and teratogenicity in mice. *Toxicol Appl Pharmacol* 47:79-88.
- *Noda M, Takano T, Sakurai H. 1979. Mutagenic activity of selenium compounds. *Mutat Res* 66:175-179.
- NOES. 1984. National occupational exposure survey (1980-1983). Cincinnati, OH: National Institute for Occupational Safety and Health, Department of Health and Human Services.
- *NOHS. 1976. National occupational hazard survey (1970). Cincinnati, OH: National Institute for Occupational Safety and Health, Department of Health and Human Services.
- Nomura A, Heilbrun LK, Morris JS, et al. 1987. Serum selenium and the risk of cancer, by specific sites: Case-control analysis of prospective data. *J Natl Cancer Inst* 79:103-108.
- *Nonavinakere VK, Proctor AS, Bell RR, et al. 1999. An acute intratracheal selenium study: Immediate effects on respiration in guinea pigs. *Toxicol Lett* 104:231-237.
- Norheim C, Steinnes E. 1975. Determination of protein-bound trace elements in biological materials by gel filtration and neutron activation analysis. *Anal Chem* 47:1688.
- *Norheim G, Haugen A. 1986. Precise determination of selenium in tissue using automated wet digestion and an automated hydride generator - Atomic absorption spectroscopy system. *Acta Pharmacol Toxicol* 59 (Suppl 7):606-609.
- *Norppa H, Westermarck T, Knuutila S. 1980a. Chromosomal effects of sodium selenite *in vivo*. III. Aberrations and sister chromatid exchanges in Chinese hamster bone marrow. *Hereditas* 91:101-105.
- Norppa H, Westermarck T, Oksanen A, et al. 1980b. Chromosomal effects of sodium selenite *in vivo*. *Hereditas* 93:97-99.
- NRC. 1983. Selenium in nutrition. Revised edition. Washington, DC: Subcommittee on Selenium, Committee on Animal Nutrition, Board of Agriculture, National Research Council.

9. REFERENCES

- *NRC. 1989. Recommended dietary allowances. 10th ed. Washington, DC: Subcommittee on the Tenth Edition of the RDAs Food and Nutrition Board, Commission on Life Sciences, National Research Council. National Academy Press 6:217-224.
- *NTP. 1980a. Bioassay of selenium sulfide (dermal study) for possible carcinogenicity. Bethesda, MD: National Toxicology Program, National Cancer Institute, National Institutes of Health. NCI Technical Report Series No. 197. NTP No. 80-18.
- *NTP. 1980b. Bioassay of selsun for possible carcinogenicity. Bethesda, MD: National Toxicology Program, National Cancer Institute, National Institutes of Health. NCI Technical Report Series No. 199. NTP No. 80-19.
- *NTP. 1980c. Bioassay of selenium sulfide (gavage) for possible carcinogenicity. Bethesda, MD: National Toxicology Program, National Cancer Institute, National Institutes of Health. NCI Technical Report Series No. 194. NTP No. 80-17.
- *NTP. 1994. NTP technical report on toxicity studies of sodium selenate and sodium selenite administered in drinking water to F344/N rats and B6C3F₁ mice. Bethesda, MD: National Toxicology Program, Toxicity Report Series Number 38. NIH Publication 94-3387.
- *NTP. 1996. Sodium selenate: Short term reproductive and developmental toxicity study when administered to Sprague-Dawley rats in the drinking water. Research Triangle Park, NC: National Toxicology Program, Department of Health and Human Services. NTIS PB 96 190 616.
- Nyberg-Swenson BE. 1999. The selenium link: The missing link in our understanding of biochemical trigger reactions? *Med Hypotheses* 52(2):125-131.
- Nylander M, Weiner J. 1991. Mercury and selenium concentrations and their interrelations in organs from dental staff and the general population. *Br J Ind Med* 48(11):729-734.
- *Obermeyer BD, Palmer IS, Olson OE, et al. 1971. Toxicity of trimethylselenonium chloride in the rat with and without arsenite. *Toxicol Appl Pharmacol* 20:135-146.
- Oehm GJ, Crisp PT, Ellis J. 1991. The recovery of selenious acid aerosols on glass fiber filters. *J Air Waste Manage Assoc* 41(2):190-194.
- *Ohi G, Nishigaki HS, Tamura Y, et al. 1980. The protective potency of marine animal meat against the neurotoxicity of methylmercury: Its relationship with the organ distribution of mercury and selenium in the rat. *Food Cosmet Toxicol* 18:139-145.
- *Ohlendorf HM, Hoffman DJ, Saiki MK, et al. 1986a. Embryonic mortality and abnormalities of aquatic birds: Apparent impacts. *Sci Total Environ* 52:49-63.
- *Ohlendorf HM, Kilness AW, Simmons JL, et al. 1988. Selenium toxicosis in wild aquatic birds. *J Toxicol Environ Health* 24:67-92.
- *Ohlendorf HM, Lowe RW, Kelly PR, et al. 1986b. Selenium and heavy metals in San Francisco Bay diving ducks. *J Wildl Manage* 50:64-71.

9. REFERENCES

- *Ohta H, Imamiya S. 1986. Selenium protection against the acute cadmium toxicity in testis. *Kitasato Arch Exp Med* 59:27-36.
- Oldfield J. 1987. The two faces of selenium. *J Nutr* 117:2002-2008.
- *Olson OE. 1986. Selenium toxicity in animals with emphasis on man. *J Am Coll Toxicol* 5:45-70.
- *Olson OE, Schulte BH, Whitehead EI, et al. 1963. Effect of arsenic on selenium metabolism in rats. *J Agric Food Chem* 11:531-534.
- Orhan H, Marol S, Hepşen İ, et al. 1999. Effects of some probable antioxidants on selenite-induced cataract formation and oxidative stress-related parameters in rats. *Toxicology* 139:219-232.
- *Oryszczyn MP, Godin J, Frette C, et al. 1996. Decrease in selenium status in relation to coal dust exposure. *Am J Ind Med* 30:281-284.
- OSHA. 1995a. Occupational Safety and Health Administration. Code of Federal Regulations. 29 CFR 1910.1000.
- OSHA. 1995b. Occupational Safety and Health Administration. Code of Federal Regulations. 29 CFR 1910.119 Appendix A.
- *OSHA. 2001. Limits for air contaminants. Occupational Safety and Health Administration. Code of Federal Regulations. 29 CFR 1910.1000.
http://www.osha-slc.gov/OshStd_data/1910_1000_TABLE_Z-1.html. February 22, 2001.
- Osman K, Åkesson a, Berglund M, et al. 2000. Toxic and essential elements in placentas of Swedish women. *Clin Biochem* 33(2):131-138.
- Osman K, Schütz A, Åkesson B, et al. 1998. Interactions between essential and toxic elements in lead exposed children in Katowice, Poland. *Clin Biochem* 31(8):657-665.
- *Ostadalova I, Babicky A. 1980. Toxic effect of various selenium compounds on the rat in the early postnatal period. *Arch Toxicol* 45:207-211.
- *Ostadalova I, Babicky A, Kopoldova J. 1988. Selenium metabolism in rats after administration of toxic doses of selenite. *Physiol Bohemoslov* 37(2):159-164.
- *Oster JD, Tracy JE, Meyer JL, et al. 1988a. Selenium in or near the southern coast range: Well waters and vegetable crops. In: Tanji KK, Valoppi L, Woodring RC, eds. *Selenium contents in animal and human food crops grown in California*. Cooperative Extension University of California, Division of Agriculture and Natural Resources. Publication 3330, 51-55.
- *Oster O, Prellwitz W. 1982. A methodological comparison of hydride and carbon furnace atomic absorption spectroscopy for the determination of selenium in serum. *Clin Chim Acta* 124:277-291.
- *Oster O, Prellwitz W. 1990. The renal excretion of selenium. *Biol Trace Elem Res* 24(2):119-146.
- *Oster O, Prellwitz W, Kasper W, et al. 1983. Congestive cardiomyopathy and the selenium content of serum. *Clin Chim Acta* 128:125-132.

9. REFERENCES

- *Oster O, Schmiedel G, Prellwitz W. 1988b. Correlations of blood selenium with hematological parameters in West German adults. *Biol Trace Elem Res* 15:47-81.
- *Oster O, Schmiedel G, Prellwitz W. 1988c. The organ distribution of selenium in German adults. *Biol Trace Elem Res* 15:23-45.
- *OTA. 1990. Neurotoxicity. Identifying and controlling poisons of the nervous system. Washington, DC: Office of Technology Assessment, U.S. Congress. OTA-BA-436.
- Othman AI, El Missiry MA. 1998. Role of selenium against lead toxicity in male rats. *J Biochem Mol Toxicol* 12(6):345-349.
- *O'Toole D, Raisbeck MF. 1995. Pathology of experimentally induced chronic selenosis (alkali disease) in yearling cattle. *J Vet Diagn Invest* 7:364-373.
- Ovaskainen ML, Virtamo J, Alfthan G, et al. 1993. Toenail selenium as an indicator of selenium intake among middle-aged men in an area with low soil selenium. *Am J Clin Nutr* 57(5):662-665.
- Overvad K. 1998. Selenium and cancer. In: Sandström B, Walter P, eds. *Role of trace elements for health promotion and disease prevention*. New York, NY: Kargar, 141-149.
- *Overvad K, Thorling E, Bjerring PEP. 1985. Selenium inhibits UV-light-induced skin carcinogenesis in hairless mice. *Cancer Lett* 27:163-170.
- *Owen GM, Brozek J. 1966. Influence of age, sex and nutrition on body composition during childhood and adolescence. In: Falkner F, ed. *Human development*. Philadelphia, PA: WB Saunders, 222-238.
- Pacyna JM. 1995. The origin of Arctic air pollutants: Lessons learned and future research. *Sci Total Environ* 160/161:39-53.
- *Palmer IS, Olson OE. 1974. Relative toxicities of selenite and selenate in the drinking water of rats. *J Nutr* 104:306-314.
- *Palmer IS, Arnold RC, Carlson CW. 1973. Toxicity of various selenium derivatives to chick embryos. *Poult Sci* 52:1841-1846.
- *Palmer IS, Gunsalus RP, Halveson AW, et al. 1970. Trimethylselenonium ion as a general excretory product from selenium in the rat. *Biochim Biophys Acta* 208:260-266.
- Palmquist B-M, Fagerholm P, Landau I. 1986. Selenium-induced cataract - A correlation of dry mass content and light scattering. *Eye Research* 42:35-42.
- Panter KE, James LF. 1990. Natural plant toxicants in milk: A review. *J Anim Sci* 68(3):892-904.
- *Panter KE, Hartley WJ, James LF. 1996. Comparative toxicity of selenium from seleno-DL-methionine, sodium selenate, and *Astragalus bisulcatus* in pigs. *Fund Appl Toxicol* 32:217-223.
- *Panter KE, James LF, Mayland HF. 1995. Reproductive response of ewes fed alfalfa pellets containing sodium selenate or *Astragalus bisulcatus* as a selenium source. *Vet Hum Toxicol* 37(1):30-32.

9. REFERENCES

- Parizek J. 1978. Interactions between selenium compounds and those of mercury or cadmium. *Environ Health Perspect* 25:53-55.
- *Parizek J, Ostadalova I. 1967. The protective effect of small amounts of selenite in sublimate intoxication. *Experientia* 23:142-143.
- Parizek J, Kalouskova J, Pavlik L, et al. 1992. Sex-linked, androgen-dependent differences in renal retention of trimethylselenonium ions. *Biol Trace Elem Res* 34(3):257-263.
- *Parizek J, Ostadalova I, Kalouskova J, et al. 1971a. Effect of mercuric compounds on the maternal transmission of selenium in the pregnant and lactating rat. *J Reprod Fertil* 25:157-170.
- Parizek J, Ostadalova I, Kalouskova J, et al. 1971b. The detoxifying effects of selenium. Interrelations between compounds of selenium and certain metals. In: Mertz W, Cornatzer WE, eds. *Newer trace elements in nutrition*. New York, NY: Marcel Dekker, 85-122.
- Park H-S, Park E, Kim M-S, et al. 2000. Selenite inhibits the c-Jun N-terminal kinase/stress-activated protein kinase (JNK/SAPK) through a thiol redox mechanism. *J Biol Chem* 275(4):2527-2531.
- Park Y-C, Whanger PD. 1995. Toxicity, metabolism and absorption of selenite by isolated rat hepatocytes. *Toxicology* 100:151-162.
- Parnham MJ. 1996a. The pharmaceutical potential of selenium chemistry. 3(5):7-10.
- Parnham MJ. 1996b. Pulmonary-allergy, dermatological, gastrointestinal & arthritis: The pharmaceutical potential of seleno-organic compounds. 5(7):861-870.
- Parnham M, Sies H. 2000. Ebselen: Prospective therapy for cerebral ischaemia. 9(3):607-619.
- Parshad RK. 1999. Effects of selenium toxicity on oestrous cyclicity, ovarian follicles, ovulation and foetal survival in rats. *Indian J Exp Biol* 37:615-617.
- Paton GR, Allison AC. 1972. Chromosome damage in human cell cultures induced by metal salts. *Mutat Res* 16:332-336.
- *Patterson BH, Zech LA. 1992. Development of a model for selenite metabolism in humans. *J Nutr* 122(3Suppl):709-714.
- *Patterson BH, Levander OA, Helzlsouer K, et al. 1989. Human selenite metabolism: A kinetic model. *Am J Physiol* 257(3Pt2):R556-567.
- *Patterson BH, Zech LA, Swanson CA, et al. 1993. Kinetic modeling of selenium in humans using stable isotope tracers. *J Trace Elem Electrolytes Health Dis* 7(2):117-120.
- *Paul M, Mason R, Edwards R. 1989. Effect of potential antidotes on the acute toxicity, tissue disposition and elimination of selenium in rats. *Res Commun Chem Pathol Pharmacol* 66(3):441-450.
- *Peirson DH, Cawse PA, Salmon L, et al. 1973. Trace elements in the atmospheric environment. *Nature* 241:252-256.

9. REFERENCES

- Pelton R. 1999. Selenium's got the power: This wonder supplement can play a key role in the prevention and treatment of cancer, AIDS and cardiovascular disease. *Am Drug* 216:48-49.
- Pennington JA, Young BE. 1991. Total diet study nutritional elements, 1982-1989. *J Am Diet Assoc* 91(2):179-183.
- Pennington JA, Wilson DB, Young BE, et al. 1987. Mineral content of market samples of fluid whole milk. *J Am Diet Assoc* 87:1036-1042.
- Pennington JA, Young BE, Wilson DB, et al. 1986. Mineral content of foods and total diets: The selected minerals in foods survey, 1982 to 1984. *J Am Diet Assoc* 86:876-891.
- *Pennington JA, Young BE, Wilson DB. 1989. Nutritional elements in U.S. diets: Results from the Total Diet Study, 1982 to 1986. *J Am Diet Assoc* 89:659-644.
- Penrith M-L. 1995. Acute selenium toxicosis as a cause of paralysis in pigs. *J S Afr Vet Assoc* 66(2):47-48.
- *Penrith M-L, Robinson JTR. 1996. Selenium toxicosis with focal symmetrical poliomyelomalacia in postweaning pigs in South Africa. *Onderstepoort J Vet Res* 63:171-179.
- *Peretz A, Neve J, Desmedt J, et al. 1991. Lymphocyte response is enhanced by supplementation of elderly subjects with selenium-enriched yeast. *Am J Clin Nutr* 53(5):1323-1328.
- *Perona G, Cellerino R, Guidi GC, et al. 1977. Erythrocytic glutathione peroxidase: Its relationship to plasma selenium in man. *Scand J Haematol* 19:116-120.
- *Pillay KKS, Thomas CCJ, Kaminski JW. 1969. Neutron activation analysis of selenium content of fossil fuels. *Nucl Appl Technol* 7:478-483.
- *Pillay KKS, Thomas Jr. CC, Sondel JA. 1971. Activation analysis of airborne selenium as a possible indicator of atmospheric sulfur pollutants. *Environ Sci Technol* 5:74-77.
- Pillay TS, Makgoba MW. 1992. Enhancement of epidermal growth factor (EGF) and insulin-stimulated tyrosine phosphorylation of endogenous substrates by sodium selenate. *FEBS Lett* 308(1):38-42.
- Pinochet H, De Gregori I, Lobos MG, et al. 1999. Selenium and copper in vegetables and fruits grown on long-term impacted soils from Valparaiso region, Chile. *Bull Environ Contam Toxicol* 63:327-334.
- *Pletnikova IP. 1970. Biological effect and safe concentration of selenium in drinking water. *Hyg Sanit* 35:176-180.
- Podoll KL, Bernard JB, Ullrey DE, et al. 1992. Dietary selenate versus selenite for cattle, sheep, and horses. *J Anim Sci* 70(6):1965-1970.
- *Poole CF, Evans NJ, Wibberley DG. 1977. Determination of selenium in biological samples by gas-liquid chromatography with electron-capture detection. *J Chromatogr* 136:73-83.
- Portal B, Richard MJ, Ducros V, et al. 1993. Effect of double-blind crossover selenium supplementation on biological indices of selenium status in cystic fibrosis patients. *Clin Chem* 39(6):1023-1028.

9. REFERENCES

- *Poulsen HD, Danielsen V, Nielsen TK, et al. 1989. Excessive dietary selenium to primiparous sows and their offspring. I. Influence on reproduction and growth. *Acta Vet Scand* 30(4):371-378.
- Presser TS, Ohlendorf HM. 1987. Biogeochemical cycling of selenium in the San Joaquin Valley, California. *Environmental Management* 11:805-821.
- Presser TS, Swain WC, Tidball RR, et al. 1991. Geologic sources, mobilization, and transport of selenium from the California coast ranges to the Western San Joaquin Valley: A reconnaissance study. *Govt Reports Announcements & Index (GRA&I)*, Issue 14, San Joaquin Valley Drainage Program, Sacramento, CA. NTIS/PB91-176727.
- Pretorius L, Kempster PL, van Vliet HR, et al. 1992. Simultaneous determination of arsenic, selenium and antimony in water by inductively coupled plasma hydride method. *F J Anal Chem* 342(4-5):391-393.
- *Pringle P. 1942. Occupational dermatitis following exposure to inorganic selenium compounds. *The British Journal of Dermatology and Syphilis* 54:54-58.
- Qian S, Yang P. 1990. Direct determination of selenium in flours by slurry sample introduction and platform graphite furnace atomic absorption spectrometry. *Fenxi Huaxue* 18(11):1064-1066.
- *Raie RM. 1996. Regional variation in As, Cu, Hg, and Se and interaction between them. *Ecotoxicol Environ Saf* 35:248-252.
- *Raisbeck MF. 2000. Selenosis. *Toxicology* 16(3):465-479.
- Raisbeck MF, Dahl ER, Sanchez DA, et al. 1993. Naturally occurring selenosis in Wyoming. *J Vet Diagn Invest* 5(1):84-87.
- *Raisbeck MF, O'Toole D, Schamber RA, et al. 1996. Toxicologic evaluation of a high-selenium hay diet in captive pronghorn antelope (*Antilocapra americana*). *J Wildl Dis* 32(1):9-16.
- *Raisbeck MF, Schamber RA, Belden EL. 1998. Immunotoxic effects of selenium in mammals. In: Garland T, Barr AC, eds. *Toxic plants and other natural toxicants*. New York, NY: CABI Publishing, 260-266.
- *Rajotte BJP, P'an AYS, Malick A, et al. 1996. Evaluation of selenium exposure in copper refinery workers. *J Toxicol Environ Health* 48:239-251.
- Ramakrishnan U, Manjrekar R, Rivera J, et al. 1999. Micronutrients and pregnancy outcome: A review of the literature. *Nutr Res* 19(1):103-159.
- Ramana A, Sengupta AK. 1992. Removing selenium (IV) and arsenic (V) oxyanions with tailored chelating polymers. *Journal of Environmental Engineering* 118(5):755-775.
- Rannem T, Hylander E, Ladefoged K, et al. 1996. The metabolism of [⁷⁵Se]selenite in patients with short bowel syndrome. *JPEN, J Parenter Enteral Nutr* 20(6):412-416.
- *Rao MV, Patil GR, Borole LV. 1998. Effect of mercury and selenite interaction on the mouse vital organs. *J Environ Biol* 19(3):215-220.

9. REFERENCES

- Rascati RJ. 1983. Induction of retrovirus gene expression by selenium compounds. *Mutat Res* 117:67-78.
- Rasco MA, Jacobs MM, Griffin AC. 1977. Effects of selenium on aryl hydrocarbon hydroxylase activity in cultured human lymphocytes. *Cancer Letters* 3:295-301.
- Rasekh HR, Soliman KFA. 1995. Effect of selenium on brain dopaminergic system. *FASEB J* 9(4):711.
- *Rasekh HR, Davis MD, Cooke LW, et al. 1997. The effect of selenium on the central dopaminergic system: A microdialysis study. *Life Sci* 61(11):1029-1035.
- *Ratnasinghe D, Tangrea JA, Forman MR, et al. 2000. Serum tocopherols, selenium and lung cancer risk among tin miners in China. *Cancer Causes Control* 11:129-135.
- *Rattner BA, Hoffman DJ, Melancon MJ, et al. 2000. Organochlorine and metal contaminant exposure and effects in hatching black-crowned night herons (*Nycticorax nycticorax*) in Delaware Bay. *Arch Environ Contam Toxicol* 39:38-45.
- *Ray JH, Altenburg JL. 1978. Sister-chromatid exchange induction by sodium selenite: Dependence on the presence of red blood cells or red blood cell lysate. *Mutat Res* 54:343-354.
- Ray JH, Altenburg LC. 1980. Dependence of the sister-chromatid exchange-inducing abilities of inorganic selenium compounds on the valence state of selenium. *Mutat Res* 78:261-266.
- Ray JH, Altenburg LC. 1982. Sister-chromatid exchange induction by sodium selenite: Plasma protein-bound selenium is not the active SCE-inducing metabolite of Na₂SeO₃. *Mutat Res* 102:285-296.
- *Ray JH, Altenburg JL, Jacobs MM. 1978. Effects of sodium selenite and methyl methanesulphonate or N-hydroxy-2-acetyl-amino-fluorescence co-exposure on sister chromatid exchange production in human blood cultures. *Mutat Res* 57:359-368.
- Ray NR, Ray AK. 1973. Studies on some blood pictures in relation to hemorrhagic tendency during selenium toxicity. *Ind J Physiol Allied Sci* 27:152-154.
- *Razagui IBA, Haswell SJ. 1997. The determination of mercury and selenium in maternal and neonatal scalp hair by inductively coupled plasma-mass spectrometry. *J Anal Toxicol* 21:149-153.
- *Rea HM, Thomson CD, Campbell DR, et al. 1979. Relation between erythrocyte selenium concentrations and glutathione peroxidase (EC 1.11.1.9) activities of New Zealand residents and visitors to New Zealand. *Br J Nutr* 42: 201-208.
- *Reamer DC, Veillon C. 1983. Elimination of perchloric acid in digestion of biological fluids for fluorometric determination of selenium. *Anal Chem* 55:1605-1606.
- *Reamer DC, Zoller WH. 1980. Selenium biomethylation products from soil and sewage sludge. *Science* 208:500-502.
- *Recknagel S, Brätter P, Tomiak A, et al. 1993. Determination of selenium in blood serum by ICP-OES including an on-line wet digestion and Se-hydride formation procedure. *F J Anal Chem* 346:833-836.

9. REFERENCES

- Reddy BS, Sugie S, Maruyama H, et al. 1988. Effect of dietary excess of inorganic selenium during initiation and postinitiation phases of colon carcinogenesis in F344 rats. *Cancer Res* 48:1777-1780.
- Reddy CC, Massaro EJ. 1983. Biochemistry of selenium: A brief overview. *Fundam Appl Toxicol* 3:431-443.
- Redman C, Xu MJ, Peng YM, et al. 1997. Involvement of polyamines in selenomethionine induced apoptosis and mitotic alterations in human tumor cells. *Carcinogenesis* 18(6):1195-1202.
- *Reid ME, Duffield-Lillico AJ, Garland L et al. 2002. Selenium supplementation and lung cancer incidence: an update of the nutritional prevention of cancer trial. *Cancer Epidemiol Biomarkers Prev* 11(11):1285-1291.
- Reis MF, Holzbecher J, Martinho E, et al. 1990. Determination of selenium in duplicate diets of residents of Pinhel, Portugal, by neutron activation. *Biol Trace Elem Res* 26-27:629-635.
- *Richter RC, Swami K, Chace S, et al. 1998. Determination of arsenic, selenium, and antimony in cloud water by inductively coupled plasma mass spectrometry. *Fresenius J Anal Chem* 361(2):168-173.
- Ridlington JW, Whanger PD. 1981. Interactions of selenium and antioxidants with mercury, cadmium and silver. *Fundam Appl Toxicol* 1:368-375.
- Ringstad J, Jacobsen BK, Tretli S, et al. 1988. Serum selenium concentration associated with risk of cancer. *J Clin Pathol* 41:454-457.
- Robberecht HJ, Deelsta HA. 1984. Selenium in human urine: Concentration levels and medical implications. *Clin Chim Acta* 136:107-120.
- *Robberecht H, Van Grieken R. 1982. Selenium in environmental waters: Determination, speciation and concentration levels. *Talanta* 29:823-844.
- *Robberecht H, Deelstra H, Van Grieken R. 1990. Determination of selenium in blood components by x-ray emission spectrometry. Procedures, concentration levels, and health implications. *Biol Trace Elem Res* 25(3):149-185.
- *Robberecht H, Vanden Berghe D, Deelstra H, et al. 1982. Selenium in Belgian soils and its uptake by rye-grass. *Sci Total Environ* 25:61-69.
- *Robertson DSF. 1970. Selenium, a possible teratogen? *Lancet* 1:518-519.
- *Robinson JR, Robinson MF, Levander OA, et al. 1985. Urinary excretion of selenium by New Zealand and North American human subjects on differing intakes. *Am J Clin Nutr* 41(5):1023-1031.
- Robinson JTR. 1995. Acute selenium toxicosis as a cause of paralysis in pigs. *S Afr Vet Assoc* 66(2):47-48.
- *Robinson MF, Rea HM, Friend GM, et al. 1978. On supplementing the selenium intake of New Zealanders. 2. Prolonged metabolic experiments with daily supplements of selenomethionine, selenite, and fish. *Br J Nutr* 39:589-600.

9. REFERENCES

- *Robkin MA, Swanson DR, Shepard TE. 1973. Trace metal concentrations in human fetal livers. *Trans Am Nucl Soc* 17:97-98.
- Roden M, Prskavec M, Fürsinn C, et al. 1995. Metabolic effect of sodium selenite: Insulin-like inhibition of glucagon-stimulated glycogenolysis in the isolated perfused rat liver. *Hepatology* 22(1):169-174.
- *Rodríguez Rodríguez EM, Alaejos MS, Romero CD. 1999. Chemometric studies of several minerals in milk. *J Agric Food Chem* 47:1520-1524.
- Rogers MA, Thomas DB, Davis S, et al. 1991. A case control study of oral cancer and pre-diagnostic concentrations of selenium and zinc in nail tissue. *Int J Cancer* 48(2):182-188.
- Romera-Alvira D, Roche E, Placer L. 1996. Cardiomyopathies and oxidative stress. *Med Hypotheses* 47:137-144.
- Ronai Z, Tillotson JK, Traganos F, et al. 1995. Effects of organic and inorganic selenium compounds on rat mammary tumor cells. *Int J Cancer* 63:428-434.
- *Rongpu Y, Jiachen H, Gongkan F, et al. 1986. Fluorometric determination of micro-amounts of selenium in human blood, using 2,3-diaminonaphthalene. *Med Lab Sci* 43:331-334.
- Rose J, Hutcheson S, West CR, et al. 1999. Fish mercury distribution in Massachusetts, USA lakes. *Environ Toxicol Chem* 18(7):1370-1379.
- Rosenfeld I, Beath OA. 1946a. The influence of protein diets on selenium poisoning. *Am J Vet Res* 7:52-56.
- Rosenfeld I, Beath OA. 1946b. The influence of protein diets on selenium poisoning. II. The influence of protein selenium administration. *Am J Vet Res* 7:57-61.
- *Rosenfeld I, Beath OA. 1947. Congenital malformations of eyes of sheep. *J Agri Res* 75:93-103.
- *Rosenfeld I, Beath OA. 1954. Effect of selenium on reproduction in rats. *Proc Soc Exp Biol Med* 87:295-297.
- *Rosenfeld I, Beath OA. 1964a. Selenium in relation to public health. In: *Selenium: Geobotany, biochemistry, toxicity, and nutrition*. New York, NY: Academic Press, 279-289.
- *Rosenfeld I, Beath OA. 1964b. Selenium poisoning in animals. In: *Selenium: Geobotany, biochemistry, toxicity, and nutrition*. New York, NY: Academic Press, 141-226.
- Ross HB. 1990. Biogeochemical cycling of atmospheric selenium. *Met Speciation Environ NATO ASI Ser., Ser G* Vol 23:523-543.
- Rotruck JT, Ganther H., Swanson A., et al. 1973. Selenium: Biochemical role as a component of glutathione peroxidase. *Science* 179:588-590.
- *Roy AC, Karunanithy R, Ratnam SS. 1990. Lack of correlation of selenium level in human semen with sperm count/motility. *Arch Androl* 25(1):59-62.

9. REFERENCES

- Roy WR. 1994. Groundwater contamination from municipal landfills in the USA. In: Adriano DC, Iskandar AK, Murarka IP, eds. Contamination in groundwaters. Northwood, England: Science Reviews, 411-446.
- *RTECS. 2001. Selenious acid. Registry of Toxic Effects of Chemical Substances. National Institute for Occupational Safety and Health. February, 2001.
- *RTI. 1993. Research Triangle Institute. National Listing of State Fish and Shellfish Consumption Advisories and Bans. Prepared for U.S. Environmental Protection Agency, Office of Water.
- *Rudd JWM, Turner MA. 1983a. The English-Wabigoon River system: II. Suppression of mercury and selenium bioaccumulation by suspended and bottom sediments. *Can J Fish Aquat Sci* 40:2218-2227.
- Rudd JWM, Turner MA. 1983b. The English-Wabigoon River system: V. Mercury and selenium bioaccumulation as a function of aquatic primary productivity. *Can J Fish Aquat Sci* 40:2251-2259.
- *Rudolph N, Wong SL. 1978. Selenium and glutathione peroxidase activity in maternal and cord plasma and cells. *Pediatr Res* 12:789-792.
- *Rusov C, Zivkovic R, Soldatovic B, et al. 1996. A study of selenium genotoxicity in the micronucleus test on mice. *Acta Vet (Belgrade)* 45(2-3):161-166.
- Ruta DA, Haider S. 1989. Attempted murder by selenium poisoning. *Br Med J* 299(6694):316-317
- *Sabé R, Rubio R, Garcia-Beltran L. 2001. Selenium determination in urine with atomic fluorescence detection. *Anal Chim Acta* 436(2):215-221.
- *Saeed K. 1986. Direct electrothermal atomic absorption spectrometric determination of selenium in biological fluids. Part 1 - Human Urine. *Acta Pharmacol Toxicol* 59(Suppl 7):593-597.
- Saiki MK. 1986a. A field example of selenium contamination in an aquatic food chain. Proceedings from the first annual symposium on selenium in the environment. Fresno, CA: California State University. California Agricultural Technology Institute Publication, CATI/860201, 67-75.
- Saiki MK. 1986b. Concentrations of selenium in aquatic food-chain organisms and fish exposed. In: Howard AQ, ed. Selenium and Agricultural Drainage: Implications for San Francisco Bay and the California Environment. Proc. Second Selenium Symp. Tiburon, CA: The Bay Institute of San Francisco, 25-33.
- *Saiki MK, Lowe TP. 1987. Selenium in aquatic organisms from subsurface agricultural drainage water, San Joaquin Valley, California. *Arch Environ Contam Toxicol* 16:657-670.
- Saiki MK, Jennings MR, Brumbaugh WG. 1993. Boron, molybdenum, and selenium in aquatic food chains from the lower San Joaquin River and its tributaries, California. *Arch Environ Contam Toxicol* 24(3):307-319.
- Saiki MK, Jennings MR, May TW. 1992. Selenium and other elements in freshwater fishes from the irrigated San Joaquin Valley, California. *Sci Total Environ* 126(1-2):109-137.
- Sakurai H, Tsuchiya K. 1975. A tentative recommendation for the maximum daily intake of selenium. *Environ Physiol Biochem* 5:107-118.

9. REFERENCES

Salamone JD. 1994. The involvement of nucleus accumbens dopamine in appetitive and aversive motivation. *Behav Brain Res* 61:117-133.

*Salbe AD, Levander OA. 1989. Effect of growth phase on deposition of selenium (Se) in tissues of rats fed elevated dietary levels of Se as either L - Selenomethionine or sodium selenate. In: Wendel A, eds. *Selenium in biology and medicine*. Springer-Verlag, 122-125.

*Salbe AD, Levander OA. 1990a. Comparative toxicity and tissue retention of selenium in methionine-deficient rats fed sodium selenate or L-selenomethionine. *J Nutr* 120(2):207-212.

*Salbe AD, Levander OA. 1990b. Effect of various dietary factors on the deposition of selenium in the hair and nails of rats. *J Nutr* 120(2):200-206.

*Salbe AD, Hill CH, Veillon C, et al. 1993. Relationship between serum somatomedin C levels and tissues selenium content among adults living in a seleniferous area. *Nutr Res* 13:399-405.

*Salonen J, Alfthan G, Huttunen J, et al. 1984. Association between serum selenium and the risk of cancer. *Am J Epidemiol* 120:342-349.

*Salonen J, Salonen R, Lappetelainen R, et al. 1985. Risk of cancer in relation to serum concentrations of selenium and vitamins A and E: Matched case-control analysis of prospective data. *Br Med J* 290:417-420.

*Salonen JT, Alfthan G, Huttunen JK, et al. 1982. Association between cardiovascular death and myocardial infarction and serum selenium in matched pair longitudinal study. *Lancet* 2:175-179.

*Sánchez-Ocampo A, Torres-Pérez J, Jiménez-Reyes M. 1996. Selenium levels in the serum of workers at a rubber tire repair shop. *Am Ind Hyg Assoc J* 57:72-75.

*Sandholm M. 1973. The initial fate of a trace amount of intravenously administered selenite. *Acta Pharmacol Toxicol* 33:1-5.

Sandholm M. 1975. Function of erythrocytes in attaching selenite-Se onto specific plasma proteins. *Acta Pharmacol Toxicol* 36:321-327.

*Sandholm M, Oksanen HE, Pesonen L. 1973. Uptake of selenium by aquatic organisms. *Limnology and Oceanography* 18:496-499.

Sanpera C, Morera M, Crespo S, et al. 1997. Trace elements in clutches of Yellow-legged Gulls, *Larus cachinnans*, from the Medes Islands, Spain. *Bull Environ Contam Toxicol* 59:757-762.

Sanpera C, Morera M, Ruiz X, et al. 2000. Variability of mercury and selenium levels in clutches of Audouin's gulls (*Larus audouinii*) breeding at the Chafarinas Islands, southwest Mediterranean. *Arch Environ Contam Toxicol* 39:119-123.

*Sani BP, Woodward JL, Pierson MC, et al. 1988. Specific binding proteins for selenium in rat tissues. *Carcinogenesis* 9(2):277-284.

9. REFERENCES

- Santolo GM, Yamamoto JT. 1999. Selenium in blood of predatory birds from Kesterson Reservior and other areas in California. *J Wildl Manage* 63(4):1273-1281.
- *Sanz Alaejos M, Diaz Romero C. 1993. Urinary selenium concentrations. *Clin Chem* 39(10):2040-2052.
- *Sayato Y, Hasegawa T, Taniguchi S, et al. 1993. Acute and subacute oral toxicity of selenocystine in mice. *Jap J Toxicol Environ Health* 39(4):289-296.
- Schafer L, Thorling EB. 1990. Lipid peroxidation and antioxidant supplementation in old age. *Scand J Clin Lab Invest* 50(1):69-75.
- Schauer JJ, Kleeman MJ, Cass GR, et al. 1999. Measurement of emissions from air pollution sources. 2. C₁ through C₃₀ organic compounds from medium diesel trucks. *Environ Sci Technol* 33:1578-1587.
- Schieke SM, Briviba K, Klotz L-O, et al. 1999. Activation pattern of mitogen-activated protein kinases elicited by peroxynitrite: Attenuation by selenite supplementation. *FEBS Lett* 448:301-303.
- *Schillaci M, Martin SE, Milner JA. 1982. The effects of dietary selenium on the biotransformation of 7,12-dimethyl-benzanthracene. *Mutat Res* 101:31-37.
- Schiønning JD, Eide R, Ernst E, et al. 1997. The effect of selenium on the localization of autometallographic mercury in dorsal root ganglia of rats. *Histochem J* 29:183-191.
- *Schmitt CJ, Brumbaugh WG. 1990. National contaminant biomonitoring program: Concentrations of arsenic, cadmium, copper, lead, mercury, selenium, and zinc in U.S freshwater fish, 1976-1984. *Arch Environ Contam Toxicol* 19(5):731-747.
- Schoental R. 1968. Selenium-75 in the Harderian glands and brown fat of rats given sodium selenite labelled with selenium-75. *Nature* 218:294-295.
- Schrauzer GN. 1992. Selenium. Mechanistic aspects of anticarcinogenic action. *Biol Trace Elem Res* 33:51-62.
- *Schrauzer GN. 2000. Selenomethionine: A review of its nutritional significance, metabolism and toxicity. *J Nutr* 130:1653-1656.
- Schrauzer GN. 2001. Nutritional selenium supplements: Product types, quality, and safety. *J Am Coll Nutr* 20(1):1-4.
- *Schrauzer GN, White DA. 1978. Selenium in human nutrition: Dietary intakes and effects of supplementation. *Bioinorg Chem* 8:303-318.
- *Schrauzer G, White D, Schneider C. 1976. Inhibition of the genesis of spontaneous mammary tumors in C3H mice: Effects of selenium and of selenium-antagonistic elements and their possible role in human breast cancer. *Bioinorg Chem* 6:265-270.
- *Schrauzer G, White D, Schneider C. 1977. Cancer mortality correlation studies. III. Statistical associations with dietary selenium intakes. *Bioinorg Chem* 7:23-24.

9. REFERENCES

- *Schroeder HA. 1967. Effects of selenate, selenite and tellurite on the growth and early survival of mice and rats. *J Nutr* 92:334-338.
- *Schroeder HA, Mitchener M. 1971a. Selenium and tellurium in rats: Effects on growth, survival, and tumors. *J Nutr* 101:1531-1540.
- *Schroeder HA, Mitchener M. 1971b. Toxic effects of trace elements on reproduction of mice and rats. *Arch Environ Health* 23:102-106.
- *Schroeder HA, Mitchener M. 1972. Selenium and tellurium in mice: Effects on growth, survival and tumors. *Arch Environ Health* 24:66-71.
- Schroeder RA, Orem WH, Kharaka YK. 2002. Chemical evolution of the Salton Sea, California: Nutrient and selenium dynamics. *Hydrobiologia* 473:32-45.
- *Schubert A, Holden MM, Wolf WR. 1987. Selenium content of a core group of foods based on a critical evaluation of published analytical data. *J Am Diet Assoc* 87:285-299.
- *Schultz J, Lewis HE. 1940. The excretion of volatile selenium compounds after the administration of sodium selenite to white rats. *J Biol Chem* 133:199-207.
- *Schutz DF, Turekian KK. 1965. The investigation of geographical and vertical distribution of several trace elements in seawater using neutron activation analysis. *Geochim Cosmochim Acta* 29:259-313.
- *Scudlark JR, Conko KM, Church TM. 1994. Atmospheric wet deposition of trace elements to Chesapeake Bay: CBAD study year 1 results. *Atmos Environ* 28(8):1487-1498.
- *Secor CL, Lisk DJ. 1989. Variation in the selenium content of individual Brazil nuts. *Journal of Food Safety* 9:279-281.
- Segerson EC, Johnson BH. 1979. Selenium/vitamin E and reproductive function in Angus bulls. *J Anim Sci* 48(Suppl 1):336.
- *Seko Y, Imura N. 1997. Active oxygen generation as a possible mechanism of selenium toxicity. *Biomed Environ Sci* 10:333-339.
- *Seko Y, Saito Y, Kitahara J, et al. 1989. Active oxygen generation by the reaction of selenite with reduced glutathione *in vitro*. In: Wendel A, ed. *Selenium in biology and medicine*. New York, NY: Springer-Verlag, 71-73.
- *Senff H, Kuhlwein A, Bothe C, et al. 1988. Allergic contact dermatitis from selenite. *Contact Dermatitis* 19(1):73-74.
- *Sesana G, Baj A, Toffoletto F, et al. 1992. Plasma selenium levels of the general population of an area in northern Italy. *Sci Total Environ* 120(1-2):97-102.
- *Setchell BP, Waites GMH. 1975. The blood-testis barrier. In: Creep RO, Astwood EB, Geiger SR, eds. *Handbook of physiology: Endocrinology V*. Washington, DC: American Physiological Society.

9. REFERENCES

- *Shamberger RJ. 1970. Relationship of selenium to cancer. I. Inhibitory effect of selenium on carcinogenesis. *J Natl Cancer Inst* 44:931-936.
- Shamberger RJ. 1980a. Evidence for the antimutagenicity and the mutagenicity of selenium. *Biol Trace Elem Res* 2:81-87.
- Shamberger RJ. 1980b. Selenium in the drinking water and cardiovascular disease. *J Environ Pathol Toxicol* 4:305-308.
- *Shamberger RJ. 1981. Selenium in the environment. *Sci Total Environ* 17:59-74.
- *Shamberger RJ. 1983. Cleveland, Ohio, personal communication. (As cited in Iyengar 1987).
- *Shamberger RJ. 1986. Selenium metabolism and function. *Clin Physiol Biochem* 4:42-49.
- Shamberger R, Willis CE. 1971. Selenium distribution and human cancer mortality. *CRC Crit Rev Clin Lab Sci* 2:211-221.
- Shamberger RJ, Tytko SA, Willis CE. 1974. Antioxidants and cancer. II. Selenium distribution and human cancer mortality in the United States, Canada and New Zealand. *Trace Substances in Environmental Health*:31-34.
- Shamberger RJ, Tytko SA, Willis CE. 1975. Selenium and heart disease. In: Hemphill DD, ed. *Trace substances in environmental health - IX*. Columbia, MO: University of Missouri, 15-22.
- *Shamberger RJ, Tytko SA, Willis CE. 1976. Antioxidants and cancer: Part VI. Selenium and age-adjusted human cancer mortality. *Arch Environ Health* 31:231-235.
- *Shane BS, Littman CB, Essick LA, et al. 1988. Uptake of selenium and mutagens by vegetables grown in fly ash containing greenhouse media. *J Agric Food Chem* 36(2):328-333.
- Shang F, Zhang J, Chang C. 1991. The aggression of rat soluble lens proteins caused by sodium selenite. *Shengwa Huaxue Zazhi* 7(4):476-481.
- Shani J, Livshitz T, Robberecht H, et al. 1985. Increased erythrocyte glutathione peroxidase activity in psoriatics consuming high-selenium drinking water at the Dead-Sea Psoriasis Treatment Center. *Pharmacol Res Commun* 17:479-488.
- Shearer TR, David LL. 1982. Role of calcium in selenium cataract. *Curr Eye Res* 2:777-784.
- *Shearer TR, Hadjimarkos DM. 1975. Geographic distribution of selenium in human milk. *Arch Environ Health* 30:230-233.
- Shearer TR, Anderson RS, Britton JL, et al. 1983a. Early development of selenium-induced cataract: Slit lamp evaluation. *Exp Eye Res* 1983:781-788.
- Shearer TR, Anderson RS, Britton JL. 1983b. Uptake and distribution of radioactive selenium in cataractous rat. *Curr Eye Res* 2:561-564.
- Shearer TR, David LL, Anderson RS, et al. 1992. Review of selenite cataract. *Curr Eye Res* 11(4):357-369.

9. REFERENCES

- Shearer TR, McCormack DW, DeSort DJ, et al. 1980. Histological evaluation of selenium induced cataracts. *Exp Eye Res* 31:321-333.
- Sheehan TM, Gao M. 1990. Simplified fluorometric assay of total selenium in plasma and urine. *Clin Chem* 36(12):2124-2126.
- Shen H-M, Yang C-F, Ong C-N. 1999. Sodium selenite-induced oxidative stress and apoptosis in human hepatoma HepG₂ cells. *Indian J Cancer* 81:820-828.
- Shenberg C, Mantel M, Izak-Biran T, et al. 1988. Rapid and simple determination of selenium and other trace elements in very small blood samples by XRF. *Biol Trace Elem Res* 16(1):87-95.
- Shendriker AD, West PW. 1973. Determination of selenium in the smoke from trash burning. *Environ Lett* 5:29-35.
- Shennan DB. 1988. Selenium (selenate) transport by human placental brush border membrane vesicles. *Br J Nutr* 59(1):13-19.
- Shimada T, El-Bayoumy K, Upadhyaya P, et al. 1997. Inhibition of human cytochrome P450-catalyzed oxidations of xenobiotics and procarcinogens by synthetic organoselenium compounds. *Cancer Res* 57:4757-4764.
- *Shimoishi Y. 1977. Some 1,2-diaminobenzene derivatives as reagents for gas chromatographic determination of selenium with an electron capture detector. *J Chromatogr* 13:85-93.
- Shimojo N, Homma S, Nakai I, et al. 1991. Nondestructive synchrotron radiation X-ray fluorescence imaging of trace elements on methylmercury and selenium administered guinea pigs. *Anal Lett* 24(10):1767-1778.
- *Shiobara Y, Yoshida T, Suzuki KT. 1998. Effects of dietary selenium species on Se concentrations in hair, blood, and urine. *Toxicol Appl Pharmacol* 152:309-314.
- Shisler JL, Senkevich TG, Berry ML, et al. 1998. Ultraviolet-induced cell death blocked by a selenoprotein from a human dermatropic poxvirus. *Science* 279:102-105.
- *Shrift A. 1964. A selenium cycle in nature? *Nature* 201:1304-1305.
- *Sindeeva. 1964. Mineralogy and types of deposits of selenium and tellurium. New York, NY: Interscience Publishers.
- *Singh PP, Junnarkar AY. 1991. Behavioral and toxic profile of some essential trace metal salts in mice and rats. *Indian Journal of Pharmacology* 23(3):153-159.
- Singh YN, Adam TJ, Lulf LA, et al. 1996. Acute effects of sodium selenite on the isolated mouse diaphragm and in the anesthetized rat. *J Nat Toxins* 5(3):351-360.
- Sinha R, Medina S. 1997. Inhibition of cdk2 kinase activity by methylselenocysteine in synchronized mouse mammary epithelial tumor cells. *Carcinogenesis* 18(8):1541-1547.

9. REFERENCES

- Sinha R, Said TK, Medina D. 1996. Organic and inorganic selenium compounds inhibit mouse mammary cell growth *in vitro* by different cellular pathways. *Cancer Lett* 107:277-284.
- Sinha R, Kiley SC, Lu JX, et al. 1999. Effects of methylselenocysteine on PKC activity, cdk2 phosphorylation and *gadd* gene expression in synchronized mouse mammary epithelial tumor cells. *Cancer Lett* 146:135-145.
- *Sioris LJ, Guthrie K, Pentel PR. 1980. Acute selenium poisoning [Abstract]. *Vet Hum Toxicol* 22:364.
- *Sirianni SR, Huang CC. 1983. Induction of sister chromatid exchange by various selenium compounds in Chinese hamster cells in the presence and absence of S9 mixture. *Cancer Lett* 18:109-116.
- *Skeaff JM, Dubreuil AA. 1997. Calculated 1993 emission factors of trace metals for Canadian non-ferrous smelters. *Atmos Environ* 31(10):1449-1457.
- *Skerfving S. 1978. Interaction between selenium and methylmercury. *Environ Health Perspect* 25:57-65.
- *Skowerski M, Czechowicz K, Konecki J, et al. 1997a. Effects of interaction between cadmium and selenium on hepatic metabolism in mice. Part II: Enzymatic activity and ultrastructure. *Med Sci Monit* 3(5):648-653.
- *Skowerski M, Konecki J, Czechowicz K, et al. 1997b. Effects of interaction between cadmium and selenium on hepatic metabolism in mice. Part I: The study on DNA, RNA and protein synthesis activities in mouse hepatocytes. *Med Sci Monit* 3(5):642-647.
- Skowerski M, Jasik K, Konecki J. 2000. Effects of interaction between cadmium and selenium on heart metabolism in mice: The study of RNA, protein, ANP synthesis activities and ultrastructure in mouse heart. *Med Sci Monit* 6(2):258-265.
- *Smith AM, Picciano MF, Milner JA. 1982. Selenium intakes and status of human milk and formula fed infants. *Am J Clin Nutr* 35:521-526.
- Smith BI, Donovan GA, Rae DO. 1999. Selenium toxicosis in a flock of Katahdin hair sheep. *Can Vet J* 40:192-194.
- *Smith MI, Westfall BB. 1937. Further field studies on the selenium problem in relation to public health. *Public Health Rep* 52:1375-1384.
- *Smith MI, Franke KW, Westfall BB. 1936. The selenium problem in relation to public health. A preliminary survey to determine the possibility of selenium intoxication in the rural population living on seleniferous soil. *Pub Health Rep* 51:1496-1505.
- *Smith MI, Westfall BB, Stohlman Jr. EF. 1937. The elimination of selenium and its distribution in the tissues. *Public Health Rep* 52:1171-1177.
- *Smyth JB, Wang JH, Barlow RM, et al. 1990. Experimental acute selenium intoxication in lambs. *J Comp Pathol* 102(2):197-209.
- Snook JT. 1991. Effect of ethanol use and other lifestyle variables on measures of selenium status. *Alcohol* 8(1):13-16.

9. REFERENCES

Söderberg A, Sahaf B, Rosén A. 2000. Thioredoxin reductase, a redox-active selenoprotein, is secreted by normal and neoplastic cells: Presence in human plasma. *Cancer Res* 60:2281-2289.

*Sohn OS, Blackwell L, Mathis J, et al. 1991. Excretion and tissue distribution of selenium following treatment of male F344 rats with benzylselenocyanate or sodium selenite. *Drug Metab Dispos* 19(5):865-870.

Sohn OS, Li H, Surface A, et al. 1995. Contrasting patterns of selenium excretion by female CD rats treated with chemically related chemopreventive organic selenocyanate compounds. *Anticancer Res* 15:1849-1856.

Solomons NW, Torun B, Janghorbani M, et al. 1986. Absorption of selenium from milk protein and isolated soy protein formulas. *J Pediatr Gastroenterol Nutr* 5:122-126.

Sonoyama E, Zaima K, Naora H, et al. 2001. Selenium deficiency causes abnormal mitochondria elongation in the mouse spermatid. *Teratology* 63(4):37A.

*Soullier B, Wilson P, Nigro N. 1981. Effect of selenium on azoxymethane-induced intestinal cancer in rats fed high fat diet. *Cancer Lett* 12:343-348.

*Spallholz JE. 1994. On the nature of selenium toxicity and carcinostatic activity. *Free Radic Res* 17(1):45-64.

Spallholz JE. 1997. Free radical generation by selenium compounds and their prooxidant toxicity. *Biomed Environ Sci* 10:260-270.

Spallholz JE, Boylan LM, Larsen HS. 1990. Advances in understanding selenium's role in the immune system. *Ann N Y Acad Sci* 587:123-139.

*Spallholz JE. 2001. Selenium and the prevention of cancer. Part II: Mechanisms for the carcinostatic activity of Se compounds. *The Bulletin of Selenium – Tellurium Development Association*, 1-12.

*Spencer RP, Blau M. 1962. Intestinal transport of selenium-75 selenomethionine. *Science* 136:155-156.

*SRI. 2000. Directory of chemical producers. Menlo Park, CA: SRI International.

Stadtman TC. 1974. Selenium biochemistry. Proteins containing selenium are essential components of certain bacterial and mammalian enzyme systems. *Science* 183:915-921.

*Stadtman TC. 1977. Biological function of selenium. *Nutr Rev* 35:161-166.

*Stadtman TC. 1980. Selenium-dependent enzymes. *Annu Rev Biochem* 49:93-110.

*Stadtman TC. 1983. New biological functions--Selenium-dependent nucleic acids and proteins. *Fundam Appl Toxicol* 3:420-423.

*Stadtman TC. 1987. Specific occurrence of selenium in enzymes and amino acid tRNAs. *FASEB J* 1:375-379.

9. REFERENCES

- *Stadtman TC. 1990. Selenium biochemistry. *Annu Rev Biochem* 59:111-127.
- Stadtman TC. 2000. Some functions of the essential trace element, selenium. In: Roussel et al, eds. *Trace elements in man and animals*. New York, NY: Plenum Publishers, 831-836.
- *Stajn A, Zikic RV, Ognjanovic B, et al. 1997. Effect of cadmium and selenium on the antioxidant defense system in rat kidneys. *Comp Biochem Physiol* 117C(2):167-172.
- Stampfer MJ, Morris JS, Willett WC. 1995. Toenail selenium level and lung cancer among men and women in a high seleniferous region of the USA [Abstract]. *Am J Epidemiol* 141(10):S68.
- Stapleton SR. 2000. Introduction: The selenium conundrum. *Cell Mol Life Sci* 57(13/14):1823-1824.
- St'Astna M, Nemcova I, Zyka J. 1999. ICP-MS for the determination of trace elements in clinical samples. *Anal Lett* 32(13):2531-2543.
- *Sternberg J, Brodeur J, Imbach A, et al. 1968. Metabolic studies with seleniated compounds. III. Lung excretion of selenium 75 and liver function. *Int J Appl Radiat Isot* 19:669-684.
- *Sternberg J, Imbach A. 1967. Metabolic studies with seleniated compounds. II. Turnover studies with Se75-methionine in rats. *Int J Appl Radiat Isot* 18:557.
- Stewart MS, Davis RL, Walsh LP, et al. 1997. Induction of differentiation and apoptosis by sodium selenite in human colonic carcinoma cells (HT29). *Cancer Lett* 117:35-40.
- *Stewart RD, Griffiths NM, Thompson CD, et al. 1978. Quantitative selenium metabolism in normal New Zealand women. *Br J Nutr* 40:45-54.
- *St. Germain DL, Galton VA. 1997. The deiodinase family of selenoproteins. *Thyroid* 7(4):655-668.
- *Stockigt JR. 2000. Serum thyrotropin and thyroid hormone measurements and assessment of thyroid hormone transport. In: Braverman LE, Utiger RD, eds. *Werner and Ingbar's the thyroid: A fundamental and clinical text*. Philadelphia, PA: Lippincott Williams & Wilkins
- Storelli MM, Marcotrigiano GO. 2000. Environmental contamination in Bottlenose dolphin (*Tursiops truncatus*): Relationship between levels of metals, methylmercury, and organochlorine compounds in an adult female, her neonate, and a calf. *Bull Environ Contam Toxicol* 64:333-340.
- Storelli MM, Zizzo N, Marcotrigiano GO. 1999. Heavy metals and methylmercury in tissues of Risso's dolphin (*Grampus griseus*) and Cuvier's Beaked whale (*Ziphius cavirostris*) stranded in Italy (South Adriatic Sea). *Bull Environ Contam Toxicol* 63:703-710.
- Storm DL. 1994. Chemical monitoring of California's public drinking water sources: Public exposures and health impacts. In: Wang RGM, ed. *Water contamination and health: Integration of exposure assessment, toxicology, and risk assessment*. New York, NY: Marcel Dekker, Inc., 67-124.
- *Stowe HD, Eavey AJ, Granger L, et al. 1992. Selenium toxicosis in feeder pigs. *J Am Vet Med Assoc* 201(2):292-295.

9. REFERENCES

- *Sturges WT, Shaw GE. 1993. Halogens in aerosols in central Alaska. *Atmos Environ* 27A(17/18):2969-2977.
- Styblo M, Kalouskova J, Klas J. 1991. Comparison of the kinetics of a trace and a sublethal dose of selenite in rats, with particular attention being given to blood selenium distribution. *J Trace Elem Electrolytes Health Dis* 5(3):155-164.
- *Suistomaa U, Saaranen M, Vanha-Perttula T. 1987. Determination of selenium in human spermatozoa and prostasomes using base digestion and electrothermal atomic absorption spectrophotometry. *Clin Chim Acta* 168:323-328.
- Sundberg J, Oskarsson A, Bergman K. 1991. Milk transfer of inorganic mercury to suckling rats. Interaction with selenite. *Biol Trace Elem Res* 28(1):27-38.
- *Sunde RA. 1990. Molecular biology of selenoproteins. *Annu Rev Nutr* 10:451-474.
- Sunde RA, Hoekstra WG. 1980. Incorporation of selenium from selenite and selenocystine into glutathione peroxidase in the isolated perfused rat liver. *Biochem Biophys Res Commun* 29:1181-1188.
- *Suzuki KT, Ogra Y. 2002. Metabolic pathway for selenium in the body: speciation by HPLC-ICP MS with enriched Se. *Food Addit Contam* 10(19):974-983.
- Suzuki KT, Itoh M, Ohmichi M. 1995. Detection of selenium-containing biological constituents by high-performance liquid chromatography source mass spectrometry. *J Chromatogr B Biomed Appl* 666(1):13-19.
- Svensson B-G, Mikoczy Z, Strömberg U, et al. 1995. Mortality and cancer incidence among Swedish fishermen with a high dietary intake of persistent organochlorine compounds. *Scand J Work Environ Health* 21:106-115.
- Svensson BG, Schutz A, Nilsson A, et al. 1992. Fish as a source of exposure to mercury and selenium. *Sci Total Environ* 126(1-2):61-74.
- Swaini DJ. 1955. The trace-element content of soils. Harpenden, England. *Comm Bur Soil Sci Tech Commun* 48:91.
- *Swanson CA, Patterson BH, Levander OA, et al. 1991. Human [⁷⁵Se]selenomethionine metabolism: A kinetic model. *Am J Clin Nutr* 54(5):917-926.
- Symonds HW, Sanson BF, Mather DL, et al. 1981. Selenium metabolism in the dairy cow: The influence of the liver and the effect of the form of Se salt. *Br J Nutr* 45:117-125.
- Szarek J, Fabczak J, Zasadowski A, et al. 1995. Pathomorphological pattern of the liver and kidney in rats exposed to mixed intoxication with selenium and diazinon. *Pathol Res Pract* 191(7-8):790.
- Takasago T, Peters EE, Graham DI, et al. 1997. Neuroprotective efficacy of ebselen, an anti-oxidant with anti-inflammatory actions, in a rodent model of permanent middle cerebral artery occlusion. *Br J Pharmacol* 122:1251-1256.
- Tandon SK, Magos L, Webb M. 1986. The stimulation and inhibition of the exhalation of volatile selenium. *Biochem Pharmacol* 35:2763-2766.

9. REFERENCES

- Tanzer D, Heumann KG. 1991. Determination of dissolved selenium species in environmental water samples using isotope dilution mass spectrometry. *Anal Chem* 63(18):1984-1989.
- Tappel A. 1984. Selenium-glutathione peroxidase: Properties and synthesis. *Curr Top Cell Regul* 24:87-97.
- *Tarantal AF, Willhite CC, Lasley BL, et al. 1991. Developmental toxicity of L-selenomethionine in *Macaca fascicularis*. *Fundam Appl Toxicol* 16(1):147-160.
- Terry N, Carlson C, Raab TK, et al. 1992. Rates of selenium volatilization among crop species. *J Environ Qual* 21(3):341-344.
- Tessier F, Margaritis I, Richard M-J, et al. 1995. Selenium and training effects on the glutathione system and aerobic performance. *Med Sci Sports Exer* 27(3):390-396.
- Thérond P, Malvy D, Favier A. 1997. [Toxicity of oral pharmacological doses of selenium]. *Nutr Clin Metals* 11:91-101. (French).
- *Thimaya S, SN Ganapathy. 1982. Selenium in human hair in relation to age, diet, pathological condition and serum levels. *Sci Total Environ* 23:41-49.
- Thomas BV, Knight AW, Maier KJ. 1999. Selenium bioaccumulation by the water boatman *Trichocorixa reticulata* (Guerin-Meneville). *Arch Environ Contam Toxicol* 36:295-300.
- Thompson B, Anderson B, Hunt J, et al. 1999. Relationship between sediment contamination and toxicity in San Francisco Bay. *Mar Environ Res* 48(4-5):285-309.
- *Thompson HJ, Becci PJ. 1979. Effect of graded dietary levels of selenium on tracheal carcinomas induced by 1-methyl-1-nitrosourea. *Cancer Lett* 7:215-219.
- *Thompson HJ, Becci PJ. 1980. Selenium inhibition of n-methyl-n-nitrosourea-induced mammary carcinogenesis. *J Natl Cancer Inst* 65:1299-1301.
- Thompson HJ, Herbst EJ, Meeker LD. 1986. Chemoprevention of mammary carcinogenesis: A comparative review of the efficacy of a polyamine antimetabolite, retinoids, and selenium. *J Natl Cancer Inst* 77:595-598.
- Thompson HJ, Ip C, Ganther HE. 1991. Changes in ornithine decarboxylase activity and polyamine levels in response to eight different forms of selenium. *J Inorg Biochem* 44(4):283-292.
- Thompson HJ, Meeker L, Becci P. 1981. Effect of combined selenium and retinyl acetate treatment on mammary carcinogenesis. *Cancer Res* 41:1413-1416.
- Thompson-Eagle ET, Frankenburger WT Jr. 1991. Selenium biomethylation in an alkaline, saline environment. *Water Research* 25(2):231-240.
- *Thomson CD. 1974. Recovery of large doses of selenium given as sodium selenite with or without vitamin E. *N Z Med J* 80:163-168.

9. REFERENCES

- *Thomson CD. 1977. Selenium in human health and disease: A review. Trace elements in human and animal health and disease in New Zealand. Hamilton, New Zealand: Waikato University Press, 72-83.
- *Thomson CD. 1991. Clinical consequences and assessment of low selenium status. New Zealand Medical Journal 104(919):376-377.
- *Thomson CD, Robinson MF. 1980. Selenium in human health and disease with emphasis on those aspects peculiar to New Zealand. Am J Clin Nutr 33:303-323.
- Thomson CD, Robinson MF. 1990. Selenium content of foods consumed in Otago, New Zealand. N Z Med J 103(886):130-135.
- *Thomson CD, Stewart RDH. 1973. Metabolic studies of [⁷⁵Se]selenomethionine and [⁷⁵Se]selenite in the rat. Br J Nutr 30:139-147.
- *Thomson CD, Stewart RDH. 1974. The metabolism of [⁷⁵Se]selenite in young women. Br J Nutr 32:47-57.
- *Thomson CD, Burton CE, Robinson MF. 1977. On supplementing the selenium intake of new Zealanders. 1. Short experiments with large doses of selenite or selenomethionine. Br J Nutr 39:579-587.
- *Thomson CD, Rea HM, Doesburg VM, et al. 1977. Selenium concentrations and glutathione peroxidase activities in whole blood of New Zealand residents. Br J Nutr 37:457-460.
- Thomson CD, Robinson BA, Stewart RDH, et al. 1975. Metabolic studies of [⁷⁵Se] selenocystine and [⁷⁵Se] selenomethionine in the rat. Br J Nutr 34:501-509.
- *Thorlacius-Ussing O. 1990. Selenium-induced growth retardation. Histochemical and endocrinological studies on the anterior pituitaries of selenium treated rats. Dan Med Bull 37(4):347-358.
- Thorlacius-Ussing O, Jensen FT. 1988. Selenium in the anterior pituitary of the rat after a single injection of ⁷⁵Se sodium selenite. Biol Trace Elem Res 15:277-287.
- *Thorlacius-Ussing O, Flyvbjerg A, Orskov H. 1988. Growth in young rats after termination of sodium selenite exposure: Studies of growth hormone and somatomedin C. Toxicology 48(2):167-176.
- Thorling EB, Overrad K, Geboers J. 1986. Selenium status in Europe--Human data. A multicenter study. Clin Res 18:3-7.
- Tilbury KL, Stein JE, Meador JP, et al. 1997. Chemical contaminants in harbor porpoise (*Phocoena phocoena*) from the north Atlantic coast: Tissue concentrations and intra- and inter- organ distribution. Chemosphere 34(9/10):2159-2181.
- Ting BT, Mooers CS, Janghorbani M. 1989. Isotopic determination of selenium in biological materials with inductively coupled plasma mass spectrometry. Analyst 114(6):667-674.
- *Tinsley IJ, Harr JR, Bone JF, et al. 1967. Selenium toxicity in rats. I. Growth and longevity. In: Selenium in biomedicine. Proceedings of the first annual symposium, Oregon State University, Oregon. 141-152.

9. REFERENCES

- Tkeshelashvili LK, Shearman CW, Zakour RA, et al. 1980. Effects of arsenic, selenium, and chromium on the fidelity of DNA synthesis. *Cancer Res* 40:2455-2460.
- Torres MA, Verdoy J, Alegrí A, et al. 1999. Selenium contents of human milk and infant formulas in Spain. *Sci Total Environ* 228:185-192.
- *Tracy ML, Möller G. 1990. Continuous flow vapor generation for inductively coupled argon plasma spectrometric analysis: Part. 1. Selenium. *J Assoc Anal Chem* 73(3):457-462.
- TRI93. 1995. Toxic Release Inventory. Washington, DC: U.S. Environmental Protection Agency, Office of Toxic Substances.
- TRI98. 2001. Toxic Chemical Release Inventory. Bethesda, MD: National Library of Medicine, National Toxicology Information Program.
- *TRI00. 2002. TRI explorer: Providing access to EPA's toxics release inventory data. Washington, DC: Office of Information Analysis and Access. Offices of Environmental Information. U.S. Environmental Protection Agency. Toxic Release Inventory. <http://www.epa.gov/triexplorer/>. April 27, 2001.
- *Tsunoda M, Johnson VJ, Sharma RP. 2000. Increase in dopamine metabolites in murine striatum after oral exposure to inorganic but not organic form of selenium. *Arch Environ Contam Toxicol* 39:32-37.
- *Tsunami H, Okawa K, Hosoya T. 1960. Experimental selenium poisoning. Part 1. The influence of absorbed selenium on the physical activities of young animals (mice). *Yokohama Med Bull* 11:368-396.
- Turan B, Fliss H, Désilets M. 1997. Oxidants increase intracellular free Zn²⁺ concentration in rabbit ventricular myocytes. *Am J Physiol* 272(5 Pt 20):H2095-2106.
- *Turan B, Hotomaroğlu Ö, Kilic M, et al. 1999a. Cardiac dysfunction induced by low and high diet antioxidant levels comparing selenium and vitamin E in rats. *Regul Toxicol Pharmacol* 29:142-150.
- *Turan B, Saran Y, Can B, et al. 1999b. Effect of high dietary selenium on the ultrastructure of cardiac muscle cells in the rabbit. *Med Sci Res* 27:795-799.
- Turner JC, Osborn PJ, McVeagh SM. 1990. Studies on selenate and selenite absorption by sheep ileum using an everted sac method and an isolated, vascularly perfused system. *Comp Biochem Physiol [A]* 95(2):297-301.
- *Ueda H, Kuroda K, Endo G. 1997. The inhibitory effect of selenium on induction of tetraploidy by dimethylarsinic acid in Chinese hamster cells. *Anticancer Res* 17:1939-1944.
- Ullrey DE. 1987. Biochemical and physiological indicators of selenium status in animals. *J Anim Sci* 65:1712-1726.
- Ullrey DE. 1992. Basis for regulation of selenium supplements in animal diets. *J Anim Sci* 70(12):3922-3927.
- *Underwood EJE. 1977. Trace elements in human and animal nutrition. 4th ed. New York, NY: Academic Press, 302-346.

9. REFERENCES

- *Urano T, Imura N, Naganuma A. 1997. Inhibitory effect of selenium on biliary secretion of methyl mercury in rats. *Biochem Biophys Res Commun* 238:862-867.
- Uria O, Estela JM, Cerda V, et al. 1990. A comparative study of a number of methods for sensitive selenium determination in waters and fodder correctors. *J Environ Sci Health. Part A - Environ Sci Eng* 25(4).
- Ursini F, Bindoli A. 1987. The role selenium peroxidases in the protection against oxidative damage of membranes. *Chem Phys Lipids* 44:255-276.
- Usami M, Ohno Y. 1996. Teratogenic effects of selenium compounds on cultured postimplantation rat embryos. *Teratog Carcinog Mutagen* 16:27-36.
- Usami M, Tabata H, Ohno Y. 1999a. Effects of ascorbic acid on selenium teratogenicity in cultured rat embryos. *Toxicol Lett* 105:123-128.
- Usami M, Tabata H, Ohno Y. 1999b. Effects of glutathione depletion on selenite- and selenate-induced embryotoxicity in cultured rat embryos. *Teratog Carcinog Mutagen* 19:257-266.
- USBM. 1988. Minerals yearbook. Vol. 1. United States Bureau of Mines, 29-49.
- USBR. 1986. Final Environmental Impact Statement: Kesterson Program. Sacramento, CA: U.S. Bureau of Reclamation, Mid-Pacific Region, in cooperation with U.S. Fish and Wildlife Service and U.S. Army Corps of Engineers.
- USDA. 1936. Toxicity of food containing selenium as shown by its effect on the rat. U.S. Department of Agriculture Technical Bulletin 534:1-25.
- USDA. 1938. Selenium occurrence in certain soils in the United States with a discussion. U.S. Department of Agriculture Technical Bulletin No. 601:74.
- USDA. 1941. Selenium occurrence in certain soils in the United States with a discussion. U.S. Department of Agriculture Technical Bulletin No. 783:26.
- USDA. 1961. Selenium content in soils. *Agriculture Handbook* 200. Washington, DC: U.S. Department of Agriculture, 27-34.
- USGS. 2001. Selenium. U.S. Geological Survey, Mineral Commodity Summaries.
- *USGS. 2002. Selenium. U.S. Geological Survey, Mineral Commodity Summaries. <http://minerals.usgs.gov/minerals/pubs/commodity/selenium/830400.pdf>.
- Vadgama JV, Wu Y, Shen D, et al. 2000. Effect of selenium in combination with adriamycin or taxol on several different cancer cells. *Anticancer Res* 20:1391-1414.
- Vaessen HA, Van Ooik A. 1987. Collaborative test of the fluorimetric determination of selenium in a test solution, milk powder, and bovine liver. *Z Lebensm Unters Forsch* 185:468-471.
- *Valentine JL, Faraji B, Kang HK. 1988. Human glutathione peroxidase activity in cases of high selenium exposures. *Environ Res* 45:16-27.

9. REFERENCES

- *Valentine JL, Kang HK, Dang P-M, et al. 1980. Selenium concentrations and glutathione peroxidase activities in a population exposed to selenium via drinking water. *J Toxicol Environ Health* 6:731-736.
- *Valentine JL, Kang MK, Spivey GH. 1978. Selenium in human blood, urine, and hair in response to exposure via drinking water. *Environ Res* 17:347-355.
- van den Brandt PA, Goldbohm RA, van't Veer P, et al. 1993a. A prospective cohort study on toenail selenium levels and risk of gastrointestinal cancer. *J Natl Cancer Inst* 85(3):224-229.
- van den Brandt PA, Goldbohm RA, van't Veer P, et al. 1993b. Predictors of toenail selenium levels in men and women. *Cancer Epidemiol Biomarkers Prev* 2(2):107-112.
- *van der Lelie D, Regniers L, Borremans B, et al. 1997. The VITOTOX test, an SOS bioluminescence *Salmonella typhimurium* test to measure genotoxicity kinetics. *Mutat Res* 389:279-290.
- *Vanderpas JB, Contempre B, Duale NL, et al. 1990. Iodine and selenium deficiency associated with cretinism in Northern Zaire. *Am J Clin Nutr* 53:1087-1093.
- Van Gossum A, Closset P, Noel E, et al. 1996. Deficiency in antioxidant factors in patients with alcohol-related chronic pancreatitis. *Dig Dis Sci* 41(6):1225-1231.
- van Niekerk FE, Cloete SWP, Heine EWP, et al. 1996. The effect of selenium supplementation during the early post-mating period on embryonic survival in sheep. *J SAfr Vet Assoc* 67(4):209-213.
- *Van Noord PAH, Maas MJ, De Bruin M. 1992. Nail keratin as monitor-tissue for selenium exposure. *Trace Elements in Medicine* 9(4):203-208.
- Van Rij AM, Thomson CD, McKenzie JM, et al. 1979. Selenium deficiency in total parenteral nutrition. *Am J Clin Nutr* 32:2076-2085.
- *Van Vleet JF, Meyer KB, Olander HJ. 1974. Acute selenium toxicosis induced in baby pigs by parenteral administration of selenium-vitamin E preparations. *J Am Vet Med Assoc* 165:543-547.
- *van't Veer P, van der Wielen RP, Kok FJ, et al. 1990. Selenium in diet, blood, and toenails in relation to breast cancer: A case control study. *Am J Epidemiol* 131(6):987-994.
- Vasconcellos MBA, Bode P, Ammerlaan AK, et al. 2001. Multielemental hair composition of Brazilian Indian populational groups by instrumental neutron activation analysis. *J Radioanal Nucl Chem* 249(2):491-494.
- Vendeland SC, Beilstein MA, Yeh J-Y, et al. 1995. Rat skeletal muscle selenoprotein W: cDNA clone and mRNA modulation by dietary selenium. *Proc Natl Acad Sci U S A* 92:8749-8753.
- *Vendeland SC, Deagen JT, Whanger PD. 1992. Uptake of selenotrisulfides of glutathione and cysteine by brush border membranes from rat intestines. *J Inorg Biochem* 47:131-140.
- *Vendeland SC, Deagan JT, Butler JA, et al. 1994. Uptake of selenite, selenomethionine and selenate by brush border membrane vesicles isolated from rat small intestine. *BioMetals* 7:305-312.

9. REFERENCES

- Vermeulen NP, Baldew GS, Los G, et al. 1993. Reduction of cisplatin nephrotoxicity by sodium selenite. Lack of interaction at the pharmacokinetic level of both compounds. *Drug Metab Dispos Biol Fate Chem* 21(1):30-36.
- Vernie LN. 1984. Selenium in carcinogenesis. *Biochim Biophys Acta* 738:203-217.
- Vezina D, Bleau G. 1988. High-performance liquid chromatography of selenium in biological samples. *J Chromatogr* 426(2):385-391.
- Vezina D, Belanger R, Bleau G. 1990. Microdetermination of selenium in protein fractions isolated by analytical methods. *Biol Trace Elem Res* 24(2):153-162.
- Vézina D, Mauffette F, Roberts KD, et al. 1996. Selenium-vitamin E supplementation in infertile men. *Biol Trace Elem Res* 53:65-83.
- Viccellio P, Bania T, Brent J, et al., eds. 1998. *Emergency toxicology*. 2nd ed. New York, NY: Lippincott-Raven, 519.
- *Vieira I, Sonnier M, Cresteil T. 1996. Developmental expression of *CYP2E1* in the human liver: Hypermethylation control of gene expression during the neonatal period. *Eur J Biochem* 238:476-483.
- *Vien SH, Fry RC. 1988. Ultrasensitive, simultaneous determination of arsenic, selenium, tin, and antimony in aqueous solution by hydride generation gas chromatography with photoionization detection. *Anal Chem* 60:465-472.
- *Vinceti M, Cann CA, Calzolari E, et al. 2000a. Reproductive outcomes in a population exposed long-term to inorganic selenium via drinking water. *Sci Total Environ* 250:1-7.
- *Vinceti M, Guidetti D, Pinotti M, et al. 1996. Amyotrophic lateral sclerosis after long-term exposure to drinking water with high selenium content. *Epidemiology* 7(5):529-532.
- *Vinceti M, Rothman KJ, Bergomi M, et al. 1998. Excess melanoma incidence in a cohort exposed to high levels of environmental selenium. *Cancer Epidemiol Biomarkers Prev* 7:853-856.
- Vinceti M, Rovesti S, Bergomi M, et al. 2000b. The epidemiology of selenium and human cancer. *Tumori* 86:105-118.
- *Vinceti M, Rovesti S, Gabrielli C, et al. 1995. Cancer mortality in a residential cohort exposed to environmental selenium through drinking water. *J Clin Epidemiol* 48(9):1091-1097.
- *Virtamo J, Valkeila E, Alfthan G, et al. 1987. Serum selenium and risk of cancer. A prospective follow-up of nine years. *Cancer* 60:145-148.
- *Viitak A, Hödrejärvi H, Treumann M. 1995. Concentration of microelements in the biomedica between the mother and the newborn. *44(2/3):212-217*.
- *Volgarev MN, Tscherkes LA. 1967. Further studies in tissue changes associated with sodium selenate. In: Muth OH, ed. *Selenium in biomedicine*. Proceedings of the First International Symposium, Oregon State University. Westport, CT: AVI Publishing Co., 179-184.

9. REFERENCES

- Wahba ZZ, Coogan TP, Rhodes SW, et al. 1993. Protective effects of selenium on cadmium toxicity in rats: Role of altered toxicokinetics and metallothionein. *J Toxicol Environ Health* 38(2):171-182.
- *Wahlstrom RC, Olson OE. 1959a. The relation of pre-natal and pre-weaning treatment to the effect of arsanilic acid on selenium poisoning in weanling pigs. *J Anim Sci* 18:579-582.
- *Wahlstrom RC, Olson OE. 1959b. The effect of selenium on reproduction in swine. *J Anim Sci* 18:141-145.
- Wang D, Alfthan G, Aro A, et al. 1992a. Selenium in precipitation and its effect on infiltration water and groundwater. *J Trace Elem Exp Med* 5(2):144.
- Wang GA, Zhou RH, Sun SZ, et al. 1979. Differences between blood selenium concentrations of residents in Keshan disease-affected and non-affected areas. Correlation between selenium content. *Chin Prev Med J* 13:204-206.
- Wang RD, Wang CS, Feng ZH, et al. 1992b. Investigation on the effect of selenium on T lymphocyte proliferation and its mechanisms. *J Tongji Med Univ* 12(1):33-38.
- Wang Z, Hess JL, Bunce GE. 1992. Deferoxamine effect on selenite-induced cataract formation in rats. *Invest Ophthalmol Vis Sci* 33(8):2511-2519.
- Wasowicz W, Gromadzinska J, Szram K, et al. 2001. Selenium, zinc, and copper concentrations in the blood and milk of lactating women. *Biol Trace Elem Res* 79(3):221-233.
- Watanabe C, Ohba T, Nakahara H, et al. 1988. Modification of lethal, hypothermic and hyperphagic effects of sodium selenite by reduced glutathione in mice. *Toxicology* 51(2-3):167-176.
- Watanabe C, Yin K, Kasanuma Y, et al. 1999a. *In utero* exposure to methylmercury and Se deficiency converge on the neurobehavioral outcome in mice. *Neurotoxicol Teratol* 21(1):83-88.
- Watanabe C, Yoshida K, Kasanuma Y, et al. 1999b. *In utero* methylmercury exposure differentially affects the activities of selenoenzymes in the fetal mouse brain. *Environ Res* 80:208-214.
- Waterlow JC, Garrow JS, Millward OH. 1969. The turnover of [⁷⁵Se] selenomethionine in infants and rats measured in a whole body counter. *Clin Sci* 36:489-504.
- *Watkinson JH. 1981. Changes of blood selenium in New Zealand adults with time and importation of Australian wheat. *Am J Clin Nutr* 34:936-942.
- *Weast RC, ed. 1988. *CRC handbook of chemistry and physics*. 69th ed. Boca Raton, FL: CRC Press Incorporated, B-124, B-126, B-132.
- Weisberg SB, Wilson HT, Heimbuch DG, et al. 2000. Comparison of sediment metal: Aluminum relationships between the eastern and Gulf coasts of the United States. *Environ Monit Assess* 61:373-385.
- *Weiss G, ed. 1986. *Hazardous chemicals data book*. 2nd ed. New Jersey: Noyes Data Corporation, 884-923.

9. REFERENCES

- Weiss SL, Sunde RA. 1998. *Cis*-acting elements are required for selenium regulation of glutathione peroxidase-1 mRNA levels. *RNA* 4:816-827.
- *Weissman SH, Cuddihy RG, Medinsky MA. 1983. Absorption, distribution, and retention of inhaled selenious acid and selenium metal aerosols in beagle dogs. *Toxicol Appl Pharmacol* 67:331-337.
- Welch WH, Howell WH. 1995. Toenail selenium level and lung cancer among men and women in a high seleniferous region of the USA. *Am J Epidemiol* 141:270.
- *Welsh EA, Holden JM, Wolf WR, et al. 1981. Selenium in self-selected diets of Maryland residents. *J Am Diet Assoc* 79:277-285.
- *Welz B, Melcher M. 1985. Decomposition of marine biological tissues for determination of arsenic, selenium, and mercury using hydride-generation and cold-vapor atomic absorption spectrometries. *Anal Chem* 57:427-431.
- *Welz B, Verlinden M. 1986. IUPAC interlaboratory trial - selenium determination in human body fluids using hydride-generation atomic absorption spectrometry. *Acta Pharmacol Toxicol* 59:577-580.
- Wendel A. 1997. Future trends of selenium in clinical applications. *Biomed Environ Sci* 10:359-362.
- Wendel A, Otter R. 1987. Alterations in the intermediary metabolism of selenium-deficient mice. *Biochim Biophys Acta* 925:94-100.
- Weres O, Bowman HR, Goldstein A, et al. 1990. The effect of nitrate and organic matter upon mobility of selenium in groundwater and in a water treatment process. *Water Air Soil Pollut* 49(3-4):251-272.
- Wesley RE, Collins JW. 1982. Pseudopterygium from exposure to selenium dioxide. *Ann Ophthalmol* 14:588-589.
- *West DW. 1967. Selenium containing inorganics in paper may play cancer role. *Chem Eng News* 45:12.
- West DW, Slattery ML, Robison LM, et al. 1991. Adult dietary intake and prostate cancer risk in Utah: A case control study with special emphasis on aggressive tumors. *Cancer Causes Control* 2(2):85-94.
- *West JR, Smith HW, Chasis H. 1948. Glomerular filtration rate, effective renal blood flow, and maximal tubular excretory capacity in infancy. *J Pediatr* 32:10-18.
- *Wester P, Brune D, Nordberg G. 1981. Arsenic and selenium in lung, liver, and kidney tissue from dead smelter workers. *Br J Ind Med* 38:179-184.
- *Whanger P. 1981. Selenium and heavy metal toxicity. *Selenium Biol Med [Proc Int Symp]* 2:230-255.
- Whanger PD. 1985. Metabolic interactions of selenium with cadmium, mercury, and silver. *Adv Nutr Res* 7:221-250.
- *Whanger PD. 1989. China, a country with both selenium deficiency and toxicity: Some thoughts and impressions. *J Nutr* 119(9):1236-1239.

9. REFERENCES

- *Whanger PD, Pedersen ND, Hatfield J, et al. 1976. Absorption of selenite and selenomethionine from ligated digestive tract segments in rats (39531). *Proc Soc Exp Biol Med* 153:295-297.
- *Whanger P, Vendeland S, Park Y-C, et al. 1996. Metabolism of subtoxic levels of selenium in animals and humans. *Ann Clin Lab Sci* 26(2):99-113.
- *White AF, Benson SM, Yee AW, et al. 1991. Groundwater contamination at the Kesterson Reservoir, California. 2. Geochemical parameters influencing selenium mobility. *Water Res Research* 27(6):1085-1098.
- *Whiting FF, Wei L, Stich HF. 1980. Unscheduled DNA synthesis and chromosome aberrations induced by organic selenium compounds in the presence of glutathione. *Mutat Res* 78:159-169.
- *WHO. 1987. Environmental Health Criteria 58. Selenium. Geneva, Switzerland: World Health Organization.
- WHO. 1996. Selenium. In: Trace elements in human nutrition and health. Geneva, Switzerland: World Health Organization.
- *WHO. 2001. Water, sanitation and health: Guidelines for drinking water quality. Geneva, Switzerland: World Health Organization.
http://www.who.int/water_sanitation...1th/GDWQ/Chemicals/seleniumfull.htm. February 22, 2001.
- Wichtel JJ, Craigie AL, Freeman DA, et al. 1996. Effect of selenium and iodine supplementation on growth rate and on thyroid and somatotrophic function in dairy calves at pasture. *J Dairy Sci* 79:1865-1872.
- *Widdowson EM, Dickerson JWT. 1964. Chemical composition of the body. In: Comar CL, Bronner F, eds. Mineral metabolism: An advanced treatise. Volume II: The elements Part A. New York, NY: Academic Press.
- *Wiedmeyer RH, May TW. 1993. Storage characteristics of three selenium species in water. *Arch Environ Contam Toxicol* 25:67-71.
- *Wilber CG. 1980. Toxicology of selenium: A review. *Clin Toxicol* 17:171-230.
- Willett WC. 1986. Selenium, vitamin E, fiber, and the incidence of human cancer: An epidemiological perspective. *Adv Exp Med Biol* 206:27-34.
- *Willett W, Polk B, Morris S, et al. 1983. Prediagnostic serum selenium and risk of cancer. *Lancet* 2:130-134.
- Willhite CC. 1993. Selenium teratogenesis. Species-dependent response and influence on reproduction. *Ann N Y Acad Sci* 678:169-177.
- *Willhite CC, Ferm VH, Zeise L. 1990. Route-dependent pharmacokinetics, distribution, and placental permeability of organic and inorganic selenium in hamsters. *Teratology* 42(4):359-371.
- *Willhite CC, Hawkes WC, Omaye ST, et al. 1992. Absorption, distribution and elimination of selenium as L-selenomethionine in non-human primates. *Food Chem Toxicol* 30(11):903-913.

9. REFERENCES

- Williams KT, Byers HG. 1935. Occurrence of selenium in the Colorado River and some of its tributaries. *Indust Eng Chem* 7:431-432.
- Wilson AC, Thompson HJ, Schedin PJ, et al. 1992. Effect of methylated forms of selenium on cell viability and the induction of DNA strand breakage. *Biochem Pharmacol* 43(5):1137-1141.
- *Wilson HM. 1962. Selenium oxide poisoning. *N C Med J* 23:73-75.
- Wilson TM, Drake TR. 1982. Porcine focal symmetrical poliomyelomalacia. *Can J Comp Med* 46:218-220.
- *Wilson TM, Cramer PG, Owen RL, et al. 1989. Porcine focal symmetrical poliomyelomalacia: Test for an interaction between dietary selenium and niacin. *Can J Vet Res* 53(4):454-461.
- *Wilson TM, Hammerstedt RH, Palmer IS, et al. 1988. Porcine focal symmetrical poliomyelomalacia: experimental reproduction with oral doses of encapsulated sodium selenite. *Can J Vet Res* 52(1):83-88.
- *Wilson TM, Scholz RW, Drake TR. 1983. Selenium toxicity and porcine focal symmetrical poliomyelomalacia: Description of a field outbreak and experimental reproduction. *Can J Comp Med* 47:412-421.
- *Windholz M, Budavari S, Blumetti RF, et al., eds. 1996. *The Merck index: An encyclopedia of chemicals, drugs, and biologicals*. 12th ed. Whitehouse Station, NJ: Merck & CO.
- Witte ST, Will LA, Olson CR, et al. 1993. Chronic selenosis in horses fed locally produced alfalfa hay. *J Am Vet Med Assoc* 202(3):406-409.
- Witting LA, Howrith MK. 1964. Effects of dietary selenium, methionine, fat level, and tocopherol on rat growth. *J Nutr* 84:351-357.
- *Wlodarczyk B, Biernacki B, Minta M, et al. 1995. Male golden hamster in male reproductive toxicology testing: Assessment of protective activity of selenium in acute cadmium intoxication. *Bull Environ Contam Toxicol* 54:907-912.
- Wood M. 1989. Selenium-loving plants cleanse the soil. *Agri Res* 37(5):8-9.
- Woshner VM, O'Hara TM, Bratton GR, et al. 2001. Concentrations and interactions of selected essential and non-essential elements in ringed seals and polar bears of Arctic Alaska. *J Wildl Dis* 37(4):711-721.
- *Woutersen RA, Appel MJ, Van Garderen-Hoetmer A. 1999. Modulation of pancreatic carcinogenesis by antioxidants. *Food Chem Toxicol* 37:981-984.
- Wu L, Lanfear J, Harrison PR. 1995a. The selenium metabolite selenodiglutathione induces cell death by a mechanism distinct from H₂O₂ toxicity. *Carcinogenesis* 16(7):1579-1584.
- Wu L, McGarry I, Lanfear J, et al. 1995b. Altered selenium-binding protein levels associated with selenium resistance. *Carcinogenesis* 16(11):2819-2824.

9. REFERENCES

- Wu L, Van Mantgem PJ, Guo X. 1996. Effects of forage plant and field legume species on soil selenium redistribution, leaching, and bioextraction in soils contaminated by agricultural drain water sediment. *Arch Environ Contam Toxicol* 31:329-338.
- *Wu SH, Oldfield JE, Whanger PD, et al. 1973. Effect of selenium, vitamin E, and antioxidants on testicular function in rats. *Biol Reprod* 8(5):625-629.
- *Yaeger MJ, Neiger RD, Holler L, et al. 1998. The effect of subclinical selenium toxicosis on pregnant beef cattle. *J Vet Diagn Invest* 10:268-273.
- *Yamada H, Miyamura T, Yasuda A, et al. 1994. Determination of trimethylselenonium ion and its behavior in soil. *Soil Science Plant Nutrition* 40(1):49-56.
- Yang FL, Chen Y-S, Weaver CV. 2002. Toxic level of selenium induces hepatic injury and biliary ductule apoptosis in rats. *FASEB J* 16(5):A994.
- Yang G, Gu L, Zhou R, et al. 1989. Studies of human maximal and minimal safe intake and requirements of selenium. In: Wendel A, ed. *Selenium in biology and medicine*. New York, NY: Springer-Verlag, 224-228.
- Yang GQ. 1984. Research on selenium-related problems in human health in China. *Proc 3rd Int Symp Biol Med Beijing*, 9-32.
- Yang GQ. 1985. Keshan disease: An endemic selenium-related deficiency disease. In: Chandra, ed. *Trace Elem Nutr Child Nestle Nutr*. Vol. 8. New York, NY: Raven Press, 273-290.
- Yang G-Q, Xia Y-M. 1995. Studies on human dietary requirements and safe range of dietary intakes of selenium in China and their application in the prevention of related endemic diseases. *Biomed Environ Sci* 8:187-201.
- *Yang G, Zhou R. 1994. Further observations on the human maximum safe dietary selenium intake in a seleniferous area of China. *J Trace Elem Electrolytes Health Dis* 8:159-165.
- *Yang G, Ge K, Chen J, et al. 1988. Selenium-related endemic diseases and the daily selenium requirement of humans. In: Bourne GH, ed. *World review of nutrition and dietetics. Sociological and medical aspects*. Vol. 55. Basel: Karger, 98-152.
- *Yang G, Wang S, Zhou R, et al. 1983. Endemic selenium intoxication of humans in China. *Am J Clin Nutr* 37:872-881.
- *Yang G, Yin S, Zhou R, et al. 1989a. Studies of safe maximal daily dietary Se-intake in a seleniferous area in China. II. Relation between Se-intake and the manifestation of clinical signs and certain biochemical alterations in blood and urine [published erratum appears in *J Trace Elem Electrolytes Health Dis* 1989 Dec 3(4):250]. *J Trace Elem Electrolytes Health Dis* 3(3):123-130.
- *Yang G, Zhou R, Yin S, et al. 1989b. Studies of safe maximal daily dietary selenium intake in a seleniferous area in China. I. Selenium intake and tissue selenium levels of the inhabitants. *J Trace Elem Electrolytes Health Dis* 3(2):77-87.

9. REFERENCES

- Yang GQ, Chen JS, Wen ZM, et al. 1984. The role of selenium in Keshan disease. In: Drapper G, ed. *Advances in nutrition research*. Vol. 6. New York, NY: Plenum Press, 203-231.
- Yang GQ, Wang SZ, Zhou RH, et al. 1981. Investigation on loss of hair and nail disease of unknown etiology--endemic selenosis. *Acta Acad Med Sin* 3:1-6.
- *Yiin S-J, Chern C-L, Sheu J-Y, et al. 1999. Cadmium induced lipid peroxidation in rat testes and protection by selenium. *BioMetals* 12:353-359.
- Yin SA, Sato I, Hosokawa Y, et al. 1991. The necessity of dietary vitamin B6 to selenium biopotency for tissue selenium and glutathione peroxidase in rats. *J Nutr Sci Vitaminol (Tokyo)* 37(5):509-516.
- Yin TA, Su SZ, Wang SZ, et al. 1979. Difference of the amounts of selenium excretion in urine in children of Keshan disease-affected and non-affected areas. *Chin Prev Med J* 132:207-210.
- *Yonemoto J, Hongo T, Suzuki T, et al. 1984. Toxic effects of selenodiglutathione on pregnant mice. *Toxicol Lett* 21:35-39.
- Yoshida M, Fukumoto M, Kishimoto T, et al. 1993. Effects of zinc, selenium, and calcium on the nephrotoxicity of cadmium in primary cultures of rat renal proximal epithelial cells. *Biol Trace Elem Res* 36(3):219-227.
- Yoshida M, Sunaga M, Hara I. 1990. Selenium status in workers handling aromatic nitro-amino compounds in a chemical factory. *J Toxicol Environ Health* 31(1):1-10.
- *Yoshizawa K, Willett WC, Morris SJ, et al. 1998. Study of prediagnostic selenium level in toenails and the risk of advanced prostate cancer. *J Natl Cancer Inst* 90(16):1219-1224.
- *Young J, Christian GD. 1973. Gas-chromatographic determination of selenium. *Anal Chim Acta* 65:127.
- Young JD, Crowley C, Tucker EM. 1981. Haemolysis of normal and glutathione-deficient sheep erythrocytes by selenite and tellurite. *Biochem Pharmacol* 30:2527-2530.
- *Young VR, Nahapetian A, Janghorbani M. 1982. Selenium bioavailability with reference to human nutrition. *Am J Clin Nutr* 35:1076-1088.
- Yu Q, Cerklewski FL, Whanger PD, et al. 1992. Effect of dietary fluoride on selenite toxicity in the rat. *Biol Trace Elem Res* 34(3):265-278.
- Yu SY, Zhu YJ, Li WG, et al. 1991. A preliminary report on the intervention trials of primary liver cancer in high-risk populations with nutritional supplementation of selenium in China. *Biol Trace Elem Res* 29(3):289-294.
- *Yukawa M, Suzuki-Yasumoto M, Amano K, et al. 1980. Distribution of trace elements in the human body determined by neutron activation analysis. *Arch Environ Health* 35:36-44.
- Zachara BA, Wardak C, Didkowski W, et al. 1993. Changes in blood selenium and glutathione concentrations and glutathione peroxidase activity in human pregnancy. *Gynecol Obstet Invest* 35(1):12-17.

9. REFERENCES

- Zagrodzki P, Szmigiel H, Ratajczak R, et al. 2000. The role of selenium in iodine metabolism in children with goiter. *Environ Health Perspect* 108(1):67-71.
- Zalgeviciene V, Zukiene J, Grazeliene G, et al. 1998. Embryotoxicity and teratogenicity of some derivatives of chloroethylaminophenylacetic acid. *Pathol Oncol Res* 4(1):27-29.
- *Zeisler R, Harrison SH, Wise S. 1984. Trace elements in human livers using quality control in the complete analytical process. *Biol Trace Elem Res* 6:31-49.
- *Zhang P, Ganje TJ, Page AL, et al. 1988. Growth and uptake of selenium by Swiss chard in acid and neutral soils. In: Tanji KK, Valopp L, Woodring RC, eds. *Selenium contents in animal and human food crops grown in California*. Cooperative Extension University of California, Division of Agriculture and Natural Resources. Publication 3330, 13-18.
- Zhang P, Ota R, Omaye ST, et al. 1997. Effects of mercury on selenoproteins in rats fed different levels of selenium. *Environ Nutr Interact* 1:39-52.
- Zhang X, Yang G, Gu L. 1991. Detoxification mechanism of methionine and vitamin E in selenium toxicity in rats. *Acta Nutrimenta Sinica* 13(1):32-38.
- Zhang Y, Xiao H. 1998. Antagonistic effect of calcium, zinc and selenium against cadmium induced chromosomal aberrations and micronuclei in root cells of *Hordeum vulgare*. *Mutat Res* 420:1-6.
- Zhang YQ, Frankenberger WT, Moore JN. 1999. Effect of soil moisture on dimethylselenide transport and transformation to nonvolatile selenium. *Environ Sci Technol* 33:3415-3420.
- Zhang Z, Yang X, Mu W, et al. 1999. [Selenoproteins in rats with chronic selenium intoxication]. *Weisheng Yanjiu* 28(3):155-157. (Chinese).
- Zhang Z-W, Moon C-S, Shimbo S, et al. 2000. Further reduction in lead exposure in women in general populations in Japan in the 1990s, and comparison with levels in east and south-east Asia. *Int Arch Occup Environ Health* 73:91-97.
- Zheng J, Kosmus W. 1996. Simultaneous speciation of arsenic and selenium compounds by ion-chromatography with inductively coupled plasma mass spectrometry as elemental specific detector. *J Liq Chrom & Rel Technol* 21(18):2831-2839.
- *Zhou H, Lui J. 1997. The simultaneous determination of 15 toxic elements in foods by ICP-MS. *Atom Spectrosc* 18(4):115-118.
- Zhou R, Gu L, Wan H, et al. 1996. [Selenium metabolism in rats with chronic selenium intoxication]. *Weisheng Yanjiu* 25(1):53-56. (Chinese).
- *Zhu L. 1981. Keshan Disease. In: McHowell J, ed., *Proc TEMA-4*. Australian Academy of Sciences, Canberra, 514-517.
- Zhu L-Z, Piao J-H, Xia Y, et al. 1989. Biochemical studies on selenium and Keshan Disease - The oxidant stress and defence capacity in blood of selenium-deficient children. In: Wendel A, ed. *Selenium in biology and medicine*. New York, NY: Springer-Verlag, 118-121.

9. REFERENCES

Zhu Z, Jiang W, Ganther HE, et al. 2000. *In vitro* effects of Se-allylselenocysteine and Se-propylselenocysteine on cell growth, DNA integrity, and apoptosis. *Biochem Pharmacol* 60:1467-1473.

*Ziegler EE, Edwards BB, Jensen RL, et al. 1978. Absorption and retention of lead by infants. *Pediatr Res* 12:29-34.

*Zierler S, Theodore M, Cohen A, et al. 1988. Chemical quality of maternal drinking water and congenital heart disease. *Int J Epidemiol* 17(3):589-594.

*Zi-Jian Jie Z, An P. 1992. Metabolic differences and similarities of selenium in blood and brain of the rat following the administration of different selenium compounds. *Biol Trace Elem Res* 33:135-143.

10. GLOSSARY

Absorption—The taking up of liquids by solids, or of gases by solids or liquids.

Acute Exposure—Exposure to a chemical for a duration of 14 days or less, as specified in the Toxicological Profiles.

Adsorption—The adhesion in an extremely thin layer of molecules (as of gases, solutes, or liquids) to the surfaces of solid bodies or liquids with which they are in contact.

Adsorption Coefficient (K_{oc})—The ratio of the amount of a chemical adsorbed per unit weight of organic carbon in the soil or sediment to the concentration of the chemical in solution at equilibrium.

Adsorption Ratio (K_d)—The amount of a chemical adsorbed by a sediment or soil (i.e., the solid phase) divided by the amount of chemical in the solution phase, which is in equilibrium with the solid phase, at a fixed solid/solution ratio. It is generally expressed in micrograms of chemical sorbed per gram of soil or sediment.

Benchmark Dose (BMD)—Usually defined as the lower confidence limit on the dose that produces a specified magnitude of changes in a specified adverse response. For example, a BMD_{10} would be the dose at the 95% lower confidence limit on a 10% response, and the benchmark response (BMR) would be 10%. The BMD is determined by modeling the dose response curve in the region of the dose response relationship where biologically observable data are feasible.

Benchmark Dose Model—A statistical dose-response model applied to either experimental toxicological or epidemiological data to calculate a BMD.

Bioconcentration Factor (BCF)—The quotient of the concentration of a chemical in aquatic organisms at a specific time or during a discrete time period of exposure divided by the concentration in the surrounding water at the same time or during the same period.

Biomarkers—Broadly defined as indicators signaling events in biologic systems or samples. They have been classified as markers of exposure, markers of effect, and markers of susceptibility.

Cancer Effect Level (CEL)—The lowest dose of chemical in a study, or group of studies, that produces significant increases in the incidence of cancer (or tumors) between the exposed population and its appropriate control.

Carcinogen—A chemical capable of inducing cancer.

Case-Control Study—A type of epidemiological study which examines the relationship between a particular outcome (disease or condition) and a variety of potential causative agents (such as toxic chemicals). In a case-controlled study, a group of people with a specified and well-defined outcome is identified and compared to a similar group of people without outcome.

Case Report—Describes a single individual with a particular disease or exposure. These may suggest some potential topics for scientific research but are not actual research studies.

Case Series—Describes the experience of a small number of individuals with the same disease or exposure. These may suggest potential topics for scientific research but are not actual research studies.

10. GLOSSARY

Ceiling Value—A concentration of a substance that should not be exceeded, even instantaneously.

Chronic Exposure—Exposure to a chemical for 365 days or more, as specified in the Toxicological Profiles.

Cohort Study—A type of epidemiological study of a specific group or groups of people who have had a common insult (e.g., exposure to an agent suspected of causing disease or a common disease) and are followed forward from exposure to outcome. At least one exposed group is compared to one unexposed group.

Cross-sectional Study—A type of epidemiological study of a group or groups which examines the relationship between exposure and outcome to a chemical or to chemicals at one point in time.

Data Needs—Substance-specific informational needs that if met would reduce the uncertainties of human health assessment.

Developmental Toxicity—The occurrence of adverse effects on the developing organism that may result from exposure to a chemical prior to conception (either parent), during prenatal development, or postnatally to the time of sexual maturation. Adverse developmental effects may be detected at any point in the life span of the organism.

Dose-Response Relationship—The quantitative relationship between the amount of exposure to a toxicant and the incidence of the adverse effects.

Embryotoxicity and Fetotoxicity—Any toxic effect on the conceptus as a result of prenatal exposure to a chemical; the distinguishing feature between the two terms is the stage of development during which the insult occurs. The terms, as used here, include malformations and variations, altered growth, and *in utero* death.

Environmental Protection Agency (EPA) Health Advisory—An estimate of acceptable drinking water levels for a chemical substance based on health effects information. A health advisory is not a legally enforceable federal standard, but serves as technical guidance to assist federal, state, and local officials.

Epidemiology—Refers to the investigation of factors that determine the frequency and distribution of disease or other health-related conditions within a defined human population during a specified period.

Genotoxicity—A specific adverse effect on the genome of living cells that, upon the duplication of affected cells, can be expressed as a mutagenic, clastogenic or carcinogenic event because of specific alteration of the molecular structure of the genome.

Half-life—A measure of rate for the time required to eliminate one half of a quantity of a chemical from the body or environmental media.

Immediately Dangerous to Life or Health (IDLH)—The maximum environmental concentration of a contaminant from which one could escape within 30 minutes without any escape-impairing symptoms or irreversible health effects.

Incidence—The ratio of individuals in a population who develop a specified condition to the total number of individuals in that population who could have developed that condition in a specified time period.

10. GLOSSARY

Intermediate Exposure—Exposure to a chemical for a duration of 15–364 days, as specified in the Toxicological Profiles.

Immunologic Toxicity—The occurrence of adverse effects on the immune system that may result from exposure to environmental agents such as chemicals.

Immunological Effects—Functional changes in the immune response.

In Vitro—Isolated from the living organism and artificially maintained, as in a test tube.

In Vivo—Occurring within the living organism.

Lethal Concentration_(LO) (LC_{LO})—The lowest concentration of a chemical in air which has been reported to have caused death in humans or animals.

Lethal Concentration₍₅₀₎ (LC₅₀)—A calculated concentration of a chemical in air to which exposure for a specific length of time is expected to cause death in 50% of a defined experimental animal population.

Lethal Dose_(LO) (LD_{LO})—The lowest dose of a chemical introduced by a route other than inhalation that has been reported to have caused death in humans or animals.

Lethal Dose₍₅₀₎ (LD₅₀)—The dose of a chemical which has been calculated to cause death in 50% of a defined experimental animal population.

Lethal Time₍₅₀₎ (LT₅₀)—A calculated period of time within which a specific concentration of a chemical is expected to cause death in 50% of a defined experimental animal population.

Lowest-Observed-Adverse-Effect Level (LOAEL)—The lowest exposure level of chemical in a study, or group of studies, that produces statistically or biologically significant increases in frequency or severity of adverse effects between the exposed population and its appropriate control.

Lymphoreticular Effects—Represent morphological effects involving lymphatic tissues such as the lymph nodes, spleen, and thymus.

Malformations—Permanent structural changes that may adversely affect survival, development, or function.

Minimal Risk Level (MRL)—An estimate of daily human exposure to a hazardous substance that is likely to be without an appreciable risk of adverse noncancer health effects over a specified route and duration of exposure.

Modifying Factor (MF)—A value (greater than zero) that is applied to the derivation of a minimal risk level (MRL) to reflect additional concerns about the database that are not covered by the uncertainty factors. The default value for a MF is 1.

Morbidity—State of being diseased; morbidity rate is the incidence or prevalence of disease in a specific population.

Mortality—Death; mortality rate is a measure of the number of deaths in a population during a specified interval of time.

10. GLOSSARY

Mutagen—A substance that causes mutations. A mutation is a change in the DNA sequence of a cell's DNA. Mutations can lead to birth defects, miscarriages, or cancer.

Necropsy—The gross examination of the organs and tissues of a dead body to determine the cause of death or pathological conditions.

Neurotoxicity—The occurrence of adverse effects on the nervous system following exposure to a chemical.

No-Observed-Adverse-Effect Level (NOAEL)—The dose of a chemical at which there were no statistically or biologically significant increases in frequency or severity of adverse effects seen between the exposed population and its appropriate control. Effects may be produced at this dose, but they are not considered to be adverse.

Octanol-Water Partition Coefficient (K_{ow})—The equilibrium ratio of the concentrations of a chemical in *n*-octanol and water, in dilute solution.

Odds Ratio (OR)—A means of measuring the association between an exposure (such as toxic substances and a disease or condition) which represents the best estimate of relative risk (risk as a ratio of the incidence among subjects exposed to a particular risk factor divided by the incidence among subjects who were not exposed to the risk factor). An odds ratio of greater than 1 is considered to indicate greater risk of disease in the exposed group compared to the unexposed.

Organophosphate or Organophosphorus Compound—A phosphorus containing organic compound and especially a pesticide that acts by inhibiting cholinesterase.

Permissible Exposure Limit (PEL)—An Occupational Safety and Health Administration (OSHA) allowable exposure level in workplace air averaged over an 8-hour shift of a 40-hour workweek.

Pesticide—General classification of chemicals specifically developed and produced for use in the control of agricultural and public health pests.

Pharmacokinetics—The science of quantitatively predicting the fate (disposition) of an exogenous substance in an organism. Utilizing computational techniques, it provides the means of studying the absorption, distribution, metabolism and excretion of chemicals by the body.

Pharmacokinetic Model—A set of equations that can be used to describe the time course of a parent chemical or metabolite in an animal system. There are two types of pharmacokinetic models: data-based and physiologically-based. A data-based model divides the animal system into a series of compartments which, in general, do not represent real, identifiable anatomic regions of the body whereby the physiologically-based model compartments represent real anatomic regions of the body.

Physiologically Based Pharmacodynamic (PBPD) Model—A type of physiologically-based dose-response model which quantitatively describes the relationship between target tissue dose and toxic end points. These models advance the importance of physiologically based models in that they clearly describe the biological effect (response) produced by the system following exposure to an exogenous substance.

10. GLOSSARY

Physiologically Based Pharmacokinetic (PBPK) Model—Comprised of a series of compartments representing organs or tissue groups with realistic weights and blood flows. These models require a variety of physiological information: tissue volumes, blood flow rates to tissues, cardiac output, alveolar ventilation rates and, possibly membrane permeabilities. The models also utilize biochemical information such as air/blood partition coefficients, and metabolic parameters. PBPK models are also called biologically based tissue dosimetry models.

Prevalence—The number of cases of a disease or condition in a population at one point in time.

Prospective Study—A type of cohort study in which the pertinent observations are made on events occurring after the start of the study. A group is followed over time.

q_1^* —The upper-bound estimate of the low-dose slope of the dose-response curve as determined by the multistage procedure. The q_1^* can be used to calculate an estimate of carcinogenic potency, the incremental excess cancer risk per unit of exposure (usually $\mu\text{g/L}$ for water, mg/kg/day for food, and $\mu\text{g/m}^3$ for air).

Recommended Exposure Limit (REL)—A National Institute for Occupational Safety and Health (NIOSH) time-weighted average (TWA) concentrations for up to a 10-hour workday during a 40-hour workweek.

Reference Concentration (RfC)—An estimate (with uncertainty spanning perhaps an order of magnitude) of a continuous inhalation exposure to the human population (including sensitive subgroups) that is likely to be without an appreciable risk of deleterious noncancer health effects during a lifetime. The inhalation reference concentration is for continuous inhalation exposures and is appropriately expressed in units of mg/m^3 or ppm.

Reference Dose (RfD)—An estimate (with uncertainty spanning perhaps an order of magnitude) of the daily exposure of the human population to a potential hazard that is likely to be without risk of deleterious effects during a lifetime. The RfD is operationally derived from the no-observed-adverse-effect level (NOAEL—from animal and human studies) by a consistent application of uncertainty factors that reflect various types of data used to estimate RfDs and an additional modifying factor, which is based on a professional judgment of the entire database on the chemical. The RfDs are not applicable to nonthreshold effects such as cancer.

Reportable Quantity (RQ)—The quantity of a hazardous substance that is considered reportable under the Comprehensive Environmental Response, Compensation, and Liability Act (CERCLA). Reportable quantities are (1) 1 pound or greater or (2) for selected substances, an amount established by regulation either under CERCLA or under Section 311 of the Clean Water Act. Quantities are measured over a 24-hour period.

Reproductive Toxicity—The occurrence of adverse effects on the reproductive system that may result from exposure to a chemical. The toxicity may be directed to the reproductive organs and/or the related endocrine system. The manifestation of such toxicity may be noted as alterations in sexual behavior, fertility, pregnancy outcomes, or modifications in other functions that are dependent on the integrity of this system.

Retrospective Study—A type of cohort study based on a group of persons known to have been exposed at some time in the past. Data are collected from routinely recorded events, up to the time the study is undertaken. Retrospective studies are limited to causal factors that can be ascertained from existing records and/or examining survivors of the cohort.

10. GLOSSARY

Risk—The possibility or chance that some adverse effect will result from a given exposure to a chemical.

Risk Factor—An aspect of personal behavior or lifestyle, an environmental exposure, or an inborn or inherited characteristic, that is associated with an increased occurrence of disease or other health-related event or condition.

Risk Ratio—The ratio of the risk among persons with specific risk factors compared to the risk among persons without risk factors. A risk ratio greater than 1 indicates greater risk of disease in the exposed group compared to the unexposed.

Short-Term Exposure Limit (STEL)—The American Conference of Governmental Industrial Hygienists (ACGIH) maximum concentration to which workers can be exposed for up to 15 minutes continually. No more than four excursions are allowed per day, and there must be at least 60 minutes between exposure periods. The daily Threshold Limit Value - Time Weighted Average (TLV-TWA) may not be exceeded.

Standardized Mortality Ratio (SMR)—A ratio of the observed number of deaths and the expected number of deaths in a specific standard population.

Target Organ Toxicity—This term covers a broad range of adverse effects on target organs or physiological systems (e.g., renal, cardiovascular) extending from those arising through a single limited exposure to those assumed over a lifetime of exposure to a chemical.

Teratogen—A chemical that causes structural defects that affect the development of an organism.

Threshold Limit Value (TLV)—An American Conference of Governmental Industrial Hygienists (ACGIH) concentration of a substance to which most workers can be exposed without adverse effect. The TLV may be expressed as a Time Weighted Average (TWA), as a Short-Term Exposure Limit (STEL), or as a ceiling limit (CL).

Time-Weighted Average (TWA)—An allowable exposure concentration averaged over a normal 8-hour workday or 40-hour workweek.

Toxic Dose₍₅₀₎ (TD₅₀)—A calculated dose of a chemical, introduced by a route other than inhalation, which is expected to cause a specific toxic effect in 50% of a defined experimental animal population.

Toxicokinetic—The study of the absorption, distribution and elimination of toxic compounds in the living organism.

Uncertainty Factor (UF)—A factor used in operationally deriving the Minimal Risk Level (MRL) or Reference Dose (RfD) or Reference Concentration (RfC) from experimental data. UFs are intended to account for (1) the variation in sensitivity among the members of the human population, (2) the uncertainty in extrapolating animal data to the case of human, (3) the uncertainty in extrapolating from data obtained in a study that is of less than lifetime exposure, and (4) the uncertainty in using lowest-observed-adverse-effect level (LOAEL) data rather than no-observed-adverse-effect level (NOAEL) data. A default for each individual UF is 10; if complete certainty in data exists, a value of one can be used; however a reduced UF of three may be used on a case-by-case basis, three being the approximate logarithmic average of 10 and 1.

Xenobiotic—Any chemical that is foreign to the biological system.

APPENDIX A. ATSDR MINIMAL RISK LEVELS AND WORKSHEETS

The Comprehensive Environmental Response, Compensation, and Liability Act (CERCLA) [42 U.S.C. 9601 et seq.], as amended by the Superfund Amendments and Reauthorization Act (SARA) [Pub. L. 99–499], requires that the Agency for Toxic Substances and Disease Registry (ATSDR) develop jointly with the U.S. Environmental Protection Agency (EPA), in order of priority, a list of hazardous substances most commonly found at facilities on the CERCLA National Priorities List (NPL); prepare toxicological profiles for each substance included on the priority list of hazardous substances; and assure the initiation of a research program to fill identified data needs associated with the substances.

The toxicological profiles include an examination, summary, and interpretation of available toxicological information and epidemiologic evaluations of a hazardous substance. During the development of toxicological profiles, Minimal Risk Levels (MRLs) are derived when reliable and sufficient data exist to identify the target organ(s) of effect or the most sensitive health effect(s) for a specific duration for a given route of exposure. An MRL is an estimate of the daily human exposure to a hazardous substance that is likely to be without appreciable risk of adverse noncancer health effects over a specified duration of exposure. MRLs are based on noncancer health effects only and are not based on a consideration of cancer effects. These substance-specific estimates, which are intended to serve as screening levels, are used by ATSDR health assessors to identify contaminants and potential health effects that may be of concern at hazardous waste sites. It is important to note that MRLs are not intended to define clean-up or action levels.

MRLs are derived for hazardous substances using the no-observed-adverse-effect level/uncertainty factor approach. They are below levels that might cause adverse health effects in the people most sensitive to such chemical-induced effects. MRLs are derived for acute (1–14 days), intermediate (15–364 days), and chronic (365 days and longer) durations and for the oral and inhalation routes of exposure. Currently, MRLs for the dermal route of exposure are not derived because ATSDR has not yet identified a method suitable for this route of exposure. MRLs are generally based on the most sensitive chemical-induced end point considered to be of relevance to humans. Serious health effects (such as irreparable damage to the liver or kidneys, or birth defects) are not used as a basis for establishing MRLs. Exposure to a level above the MRL does not mean that adverse health effects will occur.

APPENDIX A

MRLs are intended only to serve as a screening tool to help public health professionals decide where to look more closely. They may also be viewed as a mechanism to identify those hazardous waste sites that are not expected to cause adverse health effects. Most MRLs contain a degree of uncertainty because of the lack of precise toxicological information on the people who might be most sensitive (e.g., infants, elderly, nutritionally or immunologically compromised) to the effects of hazardous substances. ATSDR uses a conservative (i.e., protective) approach to address this uncertainty consistent with the public health principle of prevention. Although human data are preferred, MRLs often must be based on animal studies because relevant human studies are lacking. In the absence of evidence to the contrary, ATSDR assumes that humans are more sensitive to the effects of hazardous substance than animals and that certain persons may be particularly sensitive. Thus, the resulting MRL may be as much as a hundredfold below levels that have been shown to be nontoxic in laboratory animals.

Proposed MRLs undergo a rigorous review process: Health Effects/MRL Workgroup reviews within the Division of Toxicology, expert panel peer reviews, and agency wide MRL Workgroup reviews, with participation from other federal agencies and comments from the public. They are subject to change as new information becomes available concomitant with updating the toxicological profiles. Thus, MRLs in the most recent toxicological profiles supersede previously published levels. For additional information regarding MRLs, please contact the Division of Toxicology, Agency for Toxic Substances and Disease Registry, 1600 Clifton Road NE, Mailstop E-29, Atlanta, Georgia 30333.

APPENDIX A

MINIMAL RISK LEVEL (MRL) WORKSHEET

Chemical Name: Selenium
CAS Number: 7782-49-2 (elemental)
Date: June 5, 2003
Profile Status: Post Public Comments, Draft 3
Route: Inhalation Oral
Duration: Acute Intermediate Chronic
Graph Key: 101
Species: Human

Minimal Risk Level: 0.005 mg/kg/day ppm

Reference: Yang G, Zhou R. 1994. Further observations on the human maximum safe dietary selenium intake in a seleniferous area of China. J Trace Elem Electrolytes Health Dis 8:159-165.

Experimental design: This study was an examination of a group of five individuals who were recovering from selenosis, and who had been drawn from a larger population studied by the same authors (Yang et al. 1989a, 1989b). Yang et al. (1989a, 1989b) examined a population in an area of China where selenosis occurred. Data were collected on selenium levels in the diet, blood, nails, hair, urine, and milk of residents, and the incidence of clinical symptoms of selenosis (morphological changes in fingernails) was compared with dietary intake of selenium and selenium levels in blood. Selenium levels in blood corresponded to the dietary intake of selenium, and symptoms of selenosis occurred at or above a selenium intake level of 910 µg/day (0.016 mg/kg/day) (Yang et al 1989a). In 1992, Yang and Zhou (1994) reexamined five individuals from the high selenium site who had been suffering from symptoms of selenosis (loss of fingernails and hair), but were recovering (nails were regrowing). Since their earlier report, the living conditions of the population had improved; they had been cautioned against consuming high selenium foods and parts of their locally produced corn had been replaced with rice or cereals. Yang and Zhou (1994) found that the mean concentration of selenium in the blood of these selenosis patients had fallen from 1,346 µg/L (measured in 1986) to 968 µg/L (measured in 1992). Using a regression equation derived from the data in their earlier report (Yang et al. 1989b) and average body weights of 55 kg, Yang and Zhou (1994) calculated that the mean dietary intake of selenium associated with selenosis in these individuals was 1,270 µg/day (LOAEL of 0.023 mg/kg/day), while a mean intake of 819 µg selenium/day (NOAEL of 0.015 mg/kg/day) was associated with recovery.

Effects noted in study and corresponding doses: A NOAEL of 0.015 mg/kg/day for nail disease based on recovery from symptoms of selenosis, and a LOAEL of 0.023 mg/kg/day based on nail damage were calculated from selenium concentrations in blood using average body weights of 55 kg and the regression equation: $Y_{\text{blood-Se}} \text{ (mg/L)} = 8230 \times 10^{-4} X_{\text{se-intake}} \text{ (}\mu\text{g)} + 0.176$ derived in Yang et al. (1989b).

Dose and end point used for MRL derivation: 0.015 mg/kg/day; nail disease (selenosis)

NOAEL LOAEL

Uncertainty Factors used in MRL derivation:

- 10 for use of a LOAEL
- 10 for extrapolation from animals to humans
- 3 for human variability

APPENDIX A

A factor of 3 was considered appropriate because the individuals in this report were sensitive individuals drawn from the larger population in the Yang et al. (1989a, 1989b) studies and because of the supporting studies described below.

Was a conversion used from ppm in food or water to a mg/body weight dose? No.

If so, explain:

If an inhalation study in animals, list the conversion factors used in determining human equivalent dose:

NA

Other additional studies or pertinent information which lend support to this MRL:

Yang et al. (1989a, 1989b) examined a population of 349 individuals in an area of China where selenosis occurred. They collected data on selenium levels in the diet, blood, nails, hair, urine, and milk of residents at three sites with low, medium, and high selenium, and compared the incidence of clinical symptoms of selenosis (morphological changes in finger nails) with dietary intake of selenium and selenium levels in blood. They found that selenium levels in blood corresponded to the dietary intake of selenium, and that symptoms of selenosis were found at or above a selenium intake level of 910 $\mu\text{g}/\text{day}$ (0.016 mg/kg/day) (Yang et al 1989a). The population included adult men and women, teenagers, children, and infants. High selenium levels were found in individuals of all ages, but symptoms of selenosis were generally confined to adults (97% of cases) and were never observed in children younger than 12 years of age (Yang et al. 1989b). The manifestation of symptoms of selenosis was not solely dependent on selenium intake, but was subject to individual variability, as individuals who exhibited selenosis did not necessarily have the highest blood selenium levels.

Longnecker et al. (1991) examined two groups of adults (142 individuals) in areas of Wyoming and South Dakota with elevated selenium intake. The average daily intake of selenium in this population was 239 $\mu\text{g}/\text{day}$ (0.003 mg/kg/day) and some individuals consumed as much as 724 $\mu\text{g}/\text{day}$ (0.01 mg/kg/day). The highest blood concentration of selenium noted in this population was 0.67 mg/kg, a concentration lower than the 1.05 mg/L concentration associated with effects in China. No symptoms of selenosis or any other significant health effects associated with selenium exposure were reported for individuals in this study. This study suggests that the estimates of dietary intake of selenium produced by the regression equation in Yang et al. (1989b) may be conservative. Longnecker et al. (1991) reported doses of 68–724 $\mu\text{g}/\text{day}$ associated with blood concentrations of 0.18–0.67 mg/kg. If the doses from the Longnecker et al. (1991) study are placed in the regression equation from Yang et al. (1989b), blood concentrations of 0.14 and 0.88 mg/L are calculated. If it is assumed that a liter of blood weighs approximately 1 kg, then this regression equation overpredicts blood levels of selenium at the higher doses in the population from North Dakota. This provides support for additional exposure (e.g., inhalation exposure) in the Chinese population that was not accounted for in the regression equation.

Selenium is a component of all three members of the deiodinase enzyme family, the enzymes responsible for deiodination of the thyroid hormones (St. Germain and Galton 1997). Two human studies were located that describe significant decreases in triiodothyronine levels in response to elevated selenium; however, the hormone levels observed in these studies were subclinical within the normal human range and the biological significance of the effect is not clear. In the first study, Brätter and Negretti De Brätter (1996) examined a Venezuelan population with high selenium intake. Serum, erythrocyte, toenail, and breast milk selenium concentrations were determined for 65 women living in three seleniferous regions of Venezuela. Selenium dietary intakes were determined from the selenium concentration of breast milk by regression (Bratter et al. 1991), and free thyroxine (T_4), free triiodothyronine (T_3), and human thyroid stimulating hormone (TSH) levels were measured. Selenium intake ranged from 170 to 980 $\mu\text{g}/\text{day}$. There was a significant inverse correlation between free T_3 and selenium levels in serum (Spearman R

APPENDIX A

test), but free T₃, free T₄, and TSH levels were found to be within normal ranges. No symptoms of selenosis were found in the women included in this study.

In the second human study, serum hormone, semen, immunological, and hematological status was evaluated in a 120-day double blind study of healthy men (20–45 years old) who consumed a controlled diet of foods naturally low or high in selenium (Hawkes and Turek 2001; Hawkes et al. 2001). Eleven subjects were fed a diet that provided 47 µg Se/day (0.0006 mg/kg/day) for the first 21 days of the study. For the following 99 days, six of the subjects were fed a diet providing 13 µg Se/day (0.0002 mg/kg/day), and five of the remaining subjects were fed a diet providing 297 µg/day (0.004 mg/kg/day). Comprehensive evaluations were performed at weeks 3 (baseline), 17 (ending value), and several interim time points on end points that included selenium levels (in blood plasma, erythrocytes, seminal plasma, and sperm); thyroid hormone levels (serum T₃ and TSH); reproductive hormone levels (serum testosterone, follicle-stimulating hormone, luteinizing hormone, prolactin, estradiol, and progesterone); semen quality (sperm concentration, semen volume, sperm total number, fraction motile sperm, percent progressive sperm, mean forward velocity, and various sperm morphology parameters); immunological indices (complete blood counts, lymphocyte phenotypes, serum immunoglobulins (IgA, IgG, IgM); complement fractions; peripheral blood mononuclear cell (PBMNC) *in vitro* proliferative responses to mitogenic stimulation with phytohemagglutinin (PHA), concanavalin A (ConA), and pokeweed; natural-killer cell (NKC) activity; delayed-type hypersensitivity (DHS) skin responses to recall antigens (tuberculin purified-protein derivative, mumps, tetanus toxoid, candida, trichophyton, streptokinase streptase, and coccidioidin); antibody responses to diphtheria-tetanus and influenza vaccines); and hematological indices (complete blood counts, white blood cells, lymphocytes, granulocytes, platelets, erythrocytes, hematocrit, and hemoglobin concentration). For measurements repeated more than twice, the baseline value was subtracted from the value at each time point to calculate within-subject changes, and two-way repeated measures analysis of variance was used to test for significant effects of dietary selenium and time. When the selenium main effect or the selenium x time interaction was significant, the Student-Newman-Keuls comparison test was used to identify significant differences between the low-selenium and high-selenium groups at individual time points. For measurements obtained only twice (during baseline and at end of study), within-subject changes were compared between groups with a two-tailed t-test. Measurements obtained only at the end of the study were compared between groups with a two-tailed t-test without any correction. A probability of ≤0.05 was considered significant in all tests.

Selenium levels in blood plasma began to change within 3 days of starting the low- and high-selenium diets and progressively continued throughout the study (Hawkes and Turek 2001). By week 17, mean plasma selenium concentrations had increased by 109% in the high-selenium group and decreased by 38.5% in the low-selenium group. Group mean serum T₃ concentrations (averages of within-subject changes from baseline) were significantly different in the low-selenium subjects and high-selenium subjects at all time points, but the magnitudes of the changes are insufficient to be considered biologically significant in either group. In the low-selenium group, serum T₃ levels increased an average of 14 and 8% from baseline during weeks 8 and 17, respectively. In the high-selenium group, serum T₃ levels decreased an average of 23 and 11% from baseline during weeks 8 and 17, respectively. Analysis of variance (ANOVA) indicated a significant effect of dietary selenium on serum T₃ concentrations and that the magnitude of the effect was modified by the duration of exposure (i.e., the group changes in T₃ levels decreased over time). Although the decreases in serum T₃ in the high selenium group and increases in serum T₃ in the low selenium group lessened in magnitude during the study, all group mean values appear to have remained within the normal range (only week 17 values were actually reported). The respective baseline and week 17 serum T₃ values (mean±SD) were 1.82±0.36 and 1.57±0.07 nmol/L in the high-selenium group and 1.57±0.25 and 1.64±0.16 nmol/L in the low-selenium group, compared to a normal human range of 1.1–2.7 nM/L for total T₃, indicating that the changes were subclinical and not biologically significant. Serum TSH concentrations increased significantly by 32% over its baseline concentration in the high-selenium group but did not change significantly in the low-selenium group.

APPENDIX A

Baseline and ending TSH values in the high-selenium group were 2.25 ± 0.81 and 2.96 ± 1.05 mU/L, respectively, both of which are in the normal range of 0.3–4.0 mU/L (Stockigt 2000). There were no significant changes in the serum levels, nor any significant differences between groups in free or total testosterone, follicle-stimulating hormone, luteinizing hormone, prolactin, estradiol, or progesterone.

The pattern of changes in seminal plasma selenium levels was similar to that observed for blood selenium, although selenium levels in sperm did not change significantly in either group (Hawkes and Turek 2001). Mean sperm motility (average of within-subject changes from baseline in fraction of motile sperm) was significantly different in the low-selenium subjects and high-selenium subjects at week 13, but not at weeks 8 or 17. The fraction of motile sperm increased an average of 10% in the low-selenium group at week 13, and was essentially the same as baseline at week 17. Sperm motility decreased an average of 32% in the high-selenium group at week 13, and ended 17% lower than the baseline value at week 17. The ANOVA indicated a significant effect of dietary selenium on sperm motility and that the effect of selenium was modified by duration of exposure (the groups diverged over time). Baseline and ending motile sperm fractions in the high-selenium group were 0.588 ± 0.161 and 0.488 ± 0.193 , respectively; >50% motility is considered normal (FDA 1993). The decrease in sperm motility in the high-selenium group cannot be clearly attributed to exposure because the effect was not related to duration of treatment, and is unlikely to be adverse because the effect is at the low end of the normal range and not accompanied by any significant effects of high- or low-selenium treatment on sperm progression, concentration, total number, or morphology. Additionally, there were no effects of selenium on serum levels of the reproductive hormones, and changes in the thyroid hormones, which could also affect sperm function, were not outside normal ranges.

The immunological assessment showed that the high-selenium diet was not immunotoxic and had some mild and transient immune-enhancing properties (Hawkes et al. 2001). There is an indication that selenium supplementation increased the secondary immune response to diphtheria vaccine when rechallenged at the end of the study. The mean within-subject ratio of diphtheria antibody titers 14 days after reinoculation (day 116) to titers 14 days after the initial challenge at baseline (day 19) was significantly greater in the high-selenium group than in the low-selenium group (2.7 ± 1.8 -fold vs. 0.9 ± 0.6 -fold, $p=0.03$). Lymphocyte counts were significantly increased in the high-selenium group on day 45, but not at the end of the study, and there were no clear effects of selenium on numbers of activated or cytotoxic T-cells. The proliferative response of peripheral lymphocytes to stimulation with pokeweed mitogen (a B-cell mitogen) was significantly higher in the high-selenium group than in the low-selenium group on days 45 and 72, although not at the end of the study. There was no selenium-induced lymphocyte proliferation in response to the T-cell mitogens (phytohemagglutinin or concanavalin A) or changes in any of the other immunological end points. The hematological assessment (Hawkes et al. 2001) found minor mean within-subject changes from baseline in white blood cell counts that were significantly different in the low- and high-selenium groups at the last two time points (days 70 and 99); WBCs were decreased by 5% in the high-selenium group and increased by 10% in the low-selenium group at the end of the study. The changes in WBC counts were due mainly to changes in granulocytes. Lymphocyte counts were significantly increased in the high-selenium group on day 45, but not at the end of the study.

Chemical Manager: John Risher, Ph.D.

APPENDIX B. USER'S GUIDE

Chapter 1

Public Health Statement

This chapter of the profile is a health effects summary written in non-technical language. Its intended audience is the general public especially people living in the vicinity of a hazardous waste site or chemical release. If the Public Health Statement were removed from the rest of the document, it would still communicate to the lay public essential information about the chemical.

The major headings in the Public Health Statement are useful to find specific topics of concern. The topics are written in a question and answer format. The answer to each question includes a sentence that will direct the reader to chapters in the profile that will provide more information on the given topic.

Chapter 2

Relevance to Public Health

This chapter provides a health effects summary based on evaluations of existing toxicologic, epidemiologic, and toxicokinetic information. This summary is designed to present interpretive, weight-of-evidence discussions for human health end points by addressing the following questions.

1. What effects are known to occur in humans?
2. What effects observed in animals are likely to be of concern to humans?
3. What exposure conditions are likely to be of concern to humans, especially around hazardous waste sites?

The chapter covers end points in the same order they appear within the Discussion of Health Effects by Route of Exposure section, by route (inhalation, oral, dermal) and within route by effect. Human data are presented first, then animal data. Both are organized by duration (acute, intermediate, chronic). In vitro data and data from parenteral routes (intramuscular, intravenous, subcutaneous, etc.) are also considered in this chapter. If data are located in the scientific literature, a table of genotoxicity information is included.

The carcinogenic potential of the profiled substance is qualitatively evaluated, when appropriate, using existing toxicokinetic, genotoxic, and carcinogenic data. ATSDR does not currently assess cancer potency or perform cancer risk assessments. Minimal risk levels (MRLs) for noncancer end points (if derived) and the end points from which they were derived are indicated and discussed.

Limitations to existing scientific literature that prevent a satisfactory evaluation of the relevance to public health are identified in the Chapter 3 Data Needs section.

APPENDIX B

Interpretation of Minimal Risk Levels

Where sufficient toxicologic information is available, we have derived minimal risk levels (MRLs) for inhalation and oral routes of entry at each duration of exposure (acute, intermediate, and chronic). These MRLs are not meant to support regulatory action; but to acquaint health professionals with exposure levels at which adverse health effects are not expected to occur in humans.

They should help physicians and public health officials determine the safety of a community living near a chemical emission, given the concentration of a contaminant in air or the estimated daily dose in water. MRLs are based largely on toxicological studies in animals and on reports of human occupational exposure.

MRL users should be familiar with the toxicologic information on which the number is based. Chapter 2, "Relevance to Public Health," contains basic information known about the substance. Other sections such as Chapter 3 Section 3.9, "Interactions with Other Substances," and Section 3.10, "Populations that are Unusually Susceptible" provide important supplemental information.

MRL users should also understand the MRL derivation methodology. MRLs are derived using a modified version of the risk assessment methodology the Environmental Protection Agency (EPA) provides (Barnes and Dourson 1988) to determine reference doses for lifetime exposure (RfDs).

To derive an MRL, ATSDR generally selects the most sensitive end point which, in its best judgement, represents the most sensitive human health effect for a given exposure route and duration. ATSDR cannot make this judgement or derive an MRL unless information (quantitative or qualitative) is available for all potential systemic, neurological, and developmental effects. If this information and reliable quantitative data on the chosen end point are available, ATSDR derives an MRL using the most sensitive species (when information from multiple species is available) with the highest NOAEL that does not exceed any adverse effect levels. When a NOAEL is not available, a lowest-observed-adverse-effect level (LOAEL) can be used to derive an MRL, and an uncertainty factor (UF) of 10 must be employed. Additional uncertainty factors of 10 must be used both for human variability to protect sensitive subpopulations (people who are most susceptible to the health effects caused by the substance) and for interspecies variability (extrapolation from animals to humans). In deriving an MRL, these individual uncertainty factors are multiplied together. The product is then divided into the inhalation concentration or oral dosage selected from the study. Uncertainty factors used in developing a substance-specific MRL are provided in the footnotes of the LSE Tables.

Chapter 3**Health Effects****Tables and Figures for Levels of Significant Exposure (LSE)**

Tables (3-1, 3-2, and 3-3) and figures (3-1 and 3-2) are used to summarize health effects and illustrate graphically levels of exposure associated with those effects. These levels cover health effects observed at increasing dose concentrations and durations, differences in response by species, minimal risk levels (MRLs) to humans for noncancer end points, and EPA's estimated range associated with an upper-bound individual lifetime cancer risk of 1 in 10,000 to 1 in 10,000,000. Use the LSE tables and figures for a quick review of the health effects and to locate data for a specific exposure scenario. The LSE tables and figures should always be used in conjunction with the text. All entries in these tables and figures represent studies that provide reliable, quantitative estimates of No-Observed-Adverse-Effect Levels (NOAELs), Lowest-Observed-Adverse-Effect Levels (LOAELs), or Cancer Effect Levels (CELs).

APPENDIX B

The legends presented below demonstrate the application of these tables and figures. Representative examples of LSE Table 3-1 and Figure 3-1 are shown. The numbers in the left column of the legends correspond to the numbers in the example table and figure.

LEGEND**See LSE Table 3-1**

- (1) **Route of Exposure** One of the first considerations when reviewing the toxicity of a substance using these tables and figures should be the relevant and appropriate route of exposure. When sufficient data exists, three LSE tables and two LSE figures are presented in the document. The three LSE tables present data on the three principal routes of exposure, i.e., inhalation, oral, and dermal (LSE Table 3-1, 3-2, and 3-3, respectively). LSE figures are limited to the inhalation (LSE Figure 3-1) and oral (LSE Figure 3-2) routes. Not all substances will have data on each route of exposure and will not therefore have all five of the tables and figures.
- (2) **Exposure Period** Three exposure periods - acute (less than 15 days), intermediate (15–364 days), and chronic (365 days or more) are presented within each relevant route of exposure. In this example, an inhalation study of intermediate exposure duration is reported. For quick reference to health effects occurring from a known length of exposure, locate the applicable exposure period within the LSE table and figure.
- (3) **Health Effect** The major categories of health effects included in LSE tables and figures are death, systemic, immunological, neurological, developmental, reproductive, and cancer. NOAELs and LOAELs can be reported in the tables and figures for all effects but cancer. Systemic effects are further defined in the "System" column of the LSE table (see key number 18).
- (4) **Key to Figure** Each key number in the LSE table links study information to one or more data points using the same key number in the corresponding LSE figure. In this example, the study represented by key number 18 has been used to derive a NOAEL and a Less Serious LOAEL (also see the 2 "18r" data points in Figure 3-1).
- (5) **Species** The test species, whether animal or human, are identified in this column. Chapter 2, "Relevance to Public Health," covers the relevance of animal data to human toxicity and Section 3.4, "Toxicokinetics," contains any available information on comparative toxicokinetics. Although NOAELs and LOAELs are species specific, the levels are extrapolated to equivalent human doses to derive an MRL.
- (6) **Exposure Frequency/Duration** The duration of the study and the weekly and daily exposure regimen are provided in this column. This permits comparison of NOAELs and LOAELs from different studies. In this case (key number 18), rats were exposed to 1,1,2,2-tetrachloroethane via inhalation for 6 hours per day, 5 days per week, for 3 weeks. For a more complete review of the dosing regimen refer to the appropriate sections of the text or the original reference paper, i.e., Nitschke et al. 1981.
- (7) **System** This column further defines the systemic effects. These systems include: respiratory, cardiovascular, gastrointestinal, hematological, musculoskeletal, hepatic, renal, and dermal/ocular. "Other" refers to any systemic effect (e.g., a decrease in body weight) not covered in these systems. In the example of key number 18, 1 systemic effect (respiratory) was investigated.

APPENDIX B

- (8) NOAEL A No-Observed-Adverse-Effect Level (NOAEL) is the highest exposure level at which no harmful effects were seen in the organ system studied. Key number 18 reports a NOAEL of 3 ppm for the respiratory system which was used to derive an intermediate exposure, inhalation MRL of 0.005 ppm (see footnote "b").
- (9) LOAEL A Lowest-Observed-Adverse-Effect Level (LOAEL) is the lowest dose used in the study that caused a harmful health effect. LOAELs have been classified into "Less Serious" and "Serious" effects. These distinctions help readers identify the levels of exposure at which adverse health effects first appear and the gradation of effects with increasing dose. A brief description of the specific end point used to quantify the adverse effect accompanies the LOAEL. The respiratory effect reported in key number 18 (hyperplasia) is a Less serious LOAEL of 10 ppm. MRLs are not derived from Serious LOAELs.
- (10) Reference The complete reference citation is given in Chapter 9 of the profile.
- (11) CEL A Cancer Effect Level (CEL) is the lowest exposure level associated with the onset of carcinogenesis in experimental or epidemiologic studies. CELs are always considered serious effects. The LSE tables and figures do not contain NOAELs for cancer, but the text may report doses not causing measurable cancer increases.
- (12) Footnotes Explanations of abbreviations or reference notes for data in the LSE tables are found in the footnotes. Footnote "b" indicates the NOAEL of 3 ppm in key number 18 was used to derive an MRL of 0.005 ppm.

LEGEND**See Figure 3-1**

LSE figures graphically illustrate the data presented in the corresponding LSE tables. Figures help the reader quickly compare health effects according to exposure concentrations for particular exposure periods.

- (13) Exposure Period The same exposure periods appear as in the LSE table. In this example, health effects observed within the intermediate and chronic exposure periods are illustrated.
- (14) Health Effect These are the categories of health effects for which reliable quantitative data exists. The same health effects appear in the LSE table.
- (15) Levels of Exposure concentrations or doses for each health effect in the LSE tables are graphically displayed in the LSE figures. Exposure concentration or dose is measured on the log scale "y" axis. Inhalation exposure is reported in mg/m³ or ppm and oral exposure is reported in mg/kg/day.
- (16) NOAEL In this example, the open circle designated 18r identifies a NOAEL critical end point in the rat upon which an intermediate inhalation exposure MRL is based. The key number 18 corresponds to the entry in the LSE table. The dashed descending arrow indicates the extrapolation from the exposure level of 3 ppm (see entry 18 in the Table) to the MRL of 0.005 ppm (see footnote "b" in the LSE table).

APPENDIX B

- (17) CEL Key number 38r is 1 of 3 studies for which Cancer Effect Levels were derived. The diamond symbol refers to a Cancer Effect Level for the test species-mouse. The number 38 corresponds to the entry in the LSE table.
- (18) Estimated Upper-Bound Human Cancer Risk Levels This is the range associated with the upper-bound for lifetime cancer risk of 1 in 10,000 to 1 in 10,000,000. These risk levels are derived from the EPA's Human Health Assessment Group's upper-bound estimates of the slope of the cancer dose response curve at low dose levels (q_1^*).
- (19) Key to LSE Figure The Key explains the abbreviations and symbols used in the figure.

SAMPLE

1 →

TABLE 3-1. Levels of Significant Exposure to [Chemical x] - Inhalation

Key to figure ^a	Species	Exposure frequency/ duration	System	NOAEL (ppm)	LOAEL (effect)		Reference
					Less serious (ppm)	Serious (ppm)	
INTERMEDIATE EXPOSURE							
	5	6	7	8	9		10
3 →	Systemic	↓	↓	↓	↓	↓	↓
4 →	18	Rat	13 wk 5 d/wk 6 hr/d	Resp	3 ^b	10 (hyperplasia)	Nitschke et al. 1981
CHRONIC EXPOSURE							
						11	
						↓	
	38	Rat	18 mo 5 d/wk 7 hr/d			20	(CEL, multiple organs) Wong et al. 1982
	39	Rat	89-104 wk 5 d/wk 6 hr/d			10	(CEL, lung tumors, nasal tumors) NTP 1982
	40	Mouse	79-103 wk 5 d/wk 6 hr/d			10	(CEL, lung tumors, hemangiosarcomas) NTP 1982

12 →

^a The number corresponds to entries in Figure 3-1.
^b Used to derive an intermediate inhalation Minimal Risk Level (MRL) of 5×10^{-3} ppm; dose adjusted for intermittent exposure and divided by an uncertainty factor of 100 (10 for extrapolation from animal to humans, 10 for human variability).

SAMPLE

Figure 3-1. Levels of Significant Exposure to [Chemical X] - Inhalation

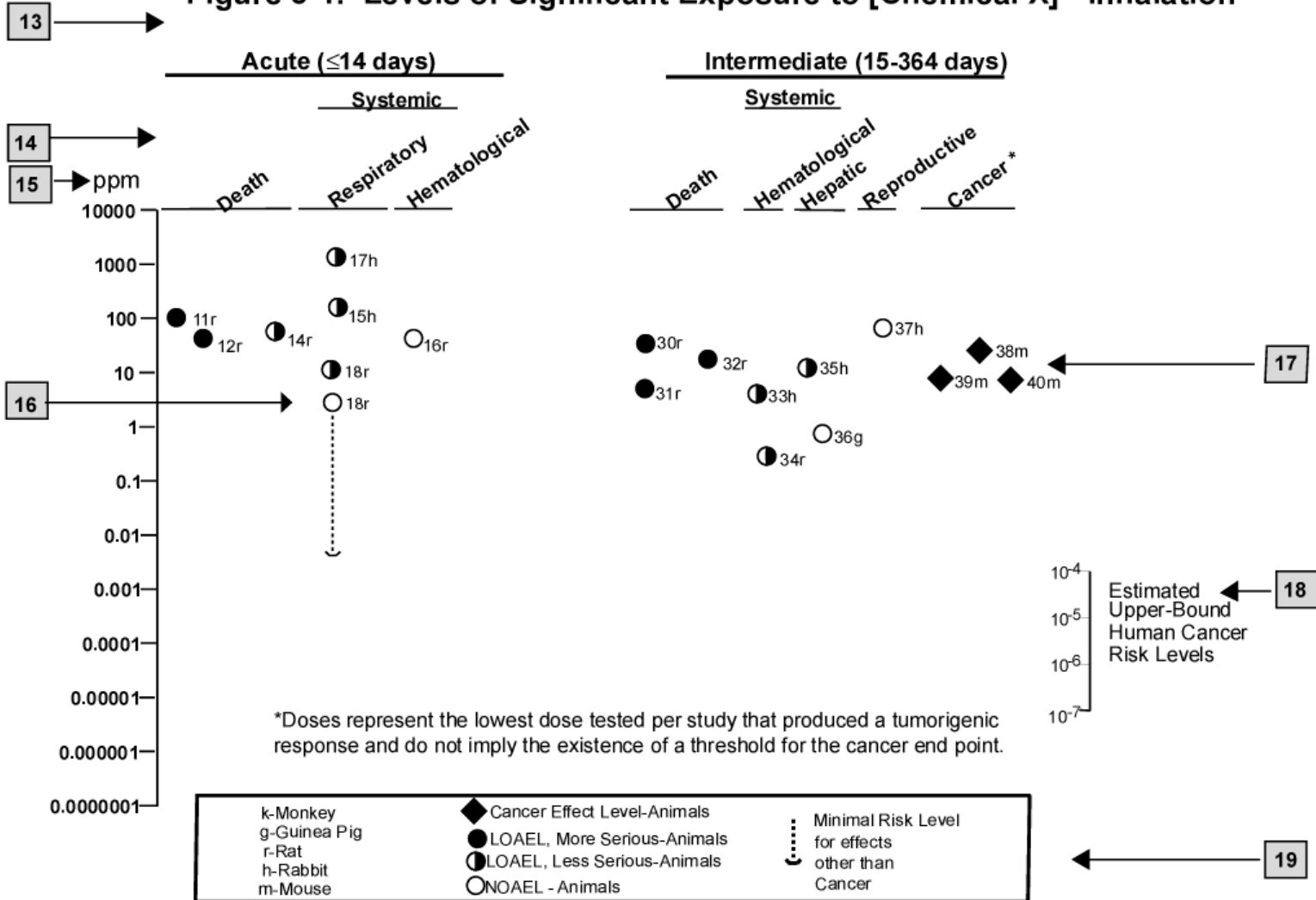

APPENDIX B

APPENDIX C. ACRONYMS, ABBREVIATIONS, AND SYMBOLS

ACOEM	American College of Occupational and Environmental Medicine
ACGIH	American Conference of Governmental Industrial Hygienists
ADI	acceptable daily intake
ADME	absorption, distribution, metabolism, and excretion
AED	atomic emission detection
AOEC	Association of Occupational and Environmental Clinics
AFID	alkali flame ionization detector
AFOSH	Air Force Office of Safety and Health
ALT	alanine aminotransferase
AML	acute myeloid leukemia
ANOVA	analysis of variance
AOAC	Association of Official Analytical Chemists
AP	alkaline phosphatase
APHA	American Public Health Association
AST	aspartate aminotransferase
atm	atmosphere
ATSDR	Agency for Toxic Substances and Disease Registry
AWQC	Ambient Water Quality Criteria
BAT	best available technology
BCF	bioconcentration factor
BEI	Biological Exposure Index
BSC	Board of Scientific Counselors
C	centigrade
CAA	Clean Air Act
CAG	Cancer Assessment Group of the U.S. Environmental Protection Agency
CAS	Chemical Abstract Services
CDC	Centers for Disease Control and Prevention
CEL	cancer effect level
CELDS	Computer-Environmental Legislative Data System
CERCLA	Comprehensive Environmental Response, Compensation, and Liability Act
CFR	Code of Federal Regulations
Ci	curie
CI	confidence interval
CL	ceiling limit value
CLP	Contract Laboratory Program
cm	centimeter
CML	chronic myeloid leukemia
CPSC	Consumer Products Safety Commission
CWA	Clean Water Act
DHEW	Department of Health, Education, and Welfare
DHHS	Department of Health and Human Services
DNA	deoxyribonucleic acid
DOD	Department of Defense
DOE	Department of Energy
DOL	Department of Labor
DOT	Department of Transportation

APPENDIX C

DOT/UN/ NA/IMCO	Department of Transportation/United Nations/ North America/International Maritime Dangerous Goods Code
DWEL	drinking water exposure level
ECD	electron capture detection
ECG/EKG	electrocardiogram
EEG	electroencephalogram
EEGL	Emergency Exposure Guidance Level
EPA	Environmental Protection Agency
F	Fahrenheit
F ₁	first-filial generation
FAO	Food and Agricultural Organization of the United Nations
FDA	Food and Drug Administration
FEMA	Federal Emergency Management Agency
FIFRA	Federal Insecticide, Fungicide, and Rodenticide Act
FPD	flame photometric detection
fpm	feet per minute
FR	<i>Federal Register</i>
FSH	follicle stimulating hormone
g	gram
GC	gas chromatography
gd	gestational day
GLC	gas liquid chromatography
GPC	gel permeation chromatography
GPX	glutathione peroxidase
GSH	glutathione
HPLC	high-performance liquid chromatography
HRGC	high resolution gas chromatography
HSDB	Hazardous Substance Data Bank
IARC	International Agency for Research on Cancer
IDLH	immediately dangerous to life and health
ILO	International Labor Organization
IRIS	Integrated Risk Information System
K _d	adsorption ratio
kg	kilogram
K _{oc}	organic carbon partition coefficient
K _{ow}	octanol-water partition coefficient
L	liter
LC	liquid chromatography
LC _{Lo}	lethal concentration, low
LC ₅₀	lethal concentration, 50% kill
LD _{Lo}	lethal dose, low
LD ₅₀	lethal dose, 50% kill
LDH	lactic dehydrogenase
LH	luteinizing hormone
LT ₅₀	lethal time, 50% kill
LOAEL	lowest-observed-adverse-effect level
LSE	Levels of Significant Exposure
m	meter
MA	<i>trans,trans</i> -muconic acid
MAL	maximum allowable level
mCi	millicurie

APPENDIX C

MCL	maximum contaminant level
MCLG	maximum contaminant level goal
MFO	mixed function oxidase
mg	milligram
mL	milliliter
mm	millimeter
mmHg	millimeters of mercury
mmol	millimole
mppcf	millions of particles per cubic foot
MRL	Minimal Risk Level
MS	mass spectrometry
NAAQS	National Ambient Air Quality Standard
NAS	National Academy of Science
NATICH	National Air Toxics Information Clearinghouse
NATO	North Atlantic Treaty Organization
NCE	normochromatic erythrocytes
NCEH	National Center for Environmental Health
NCI	National Cancer Institute
ND	not detected
NFPA	National Fire Protection Association
ng	nanogram
NIEHS	National Institute of Environmental Health Sciences
NIOSH	National Institute for Occupational Safety and Health
NIOSHTIC	NIOSH's Computerized Information Retrieval System
NLM	National Library of Medicine
nm	nanometer
NHANES	National Health and Nutrition Examination Survey
nmol	nanomole
NOAEL	no-observed-adverse-effect level
NOES	National Occupational Exposure Survey
NOHS	National Occupational Hazard Survey
NPD	nitrogen phosphorus detection
NPDES	National Pollutant Discharge Elimination System
NPL	National Priorities List
NR	not reported
NRC	National Research Council
NS	not specified
NSPS	New Source Performance Standards
NTIS	National Technical Information Service
NTP	National Toxicology Program
ODW	Office of Drinking Water, EPA
OERR	Office of Emergency and Remedial Response, EPA
OHM/TADS	Oil and Hazardous Materials/Technical Assistance Data System
OPP	Office of Pesticide Programs, EPA
OPPTS	Office of Prevention, Pesticides and Toxic Substances, EPA
OPPT	Office of Pollution Prevention and Toxics, EPA
OR	odds ratio
OSHA	Occupational Safety and Health Administration
OSW	Office of Solid Waste, EPA
OW	Office of Water
OWRS	Office of Water Regulations and Standards, EPA

APPENDIX C

PAH	polycyclic aromatic hydrocarbon
PBPD	physiologically based pharmacodynamic
PBPK	physiologically based pharmacokinetic
PCE	polychromatic erythrocytes
PEL	permissible exposure limit
pg	pictogram
PHS	Public Health Service
PID	photo ionization detector
pmol	picomole
PMR	proportionate mortality ratio
ppb	parts per billion
ppm	parts per million
ppt	parts per trillion
PSNS	pretreatment standards for new sources
RBC	red blood cell
RDA	Recommended Daily Allowance
REL	recommended exposure level/limit
RfC	reference concentration
RfD	reference dose
RNA	ribonucleic acid
RR	relative risk
RTECS	Registry of Toxic Effects of Chemical Substances
RQ	reportable quantity
SARA	Superfund Amendments and Reauthorization Act
SCE	sister chromatid exchange
SGOT	serum glutamic oxaloacetic transaminase
SGPT	serum glutamic pyruvic transaminase
SIC	standard industrial classification
SIM	selected ion monitoring
SMCL	secondary maximum contaminant level
SMR	standardized mortality ratio
SNARL	suggested no adverse response level
SPEGL	Short-Term Public Emergency Guidance Level
STEL	short term exposure limit
STORET	Storage and Retrieval
T ₃	triiodothyronine
T ₄	thyroxine
TD ₅₀	toxic dose, 50% specific toxic effect
TLV	threshold limit value
TOC	total organic carbon
TPQ	threshold planning quantity
TRI	Toxics Release Inventory
TSCA	Toxic Substances Control Act
TSH	thyroid stimulating hormone
TWA	time-weighted average
UF	uncertainty factor
UL	Tolerable Upper Intake Level
U.S.	United States
USDA	United States Department of Agriculture
USGS	United States Geological Survey
VOC	volatile organic compound

APPENDIX C

WBC	white blood cell
WHO	World Health Organization
>	greater than
≥	greater than or equal to
=	equal to
<	less than
≤	less than or equal to
%	percent
α	alpha
β	beta
γ	gamma
δ	delta
μm	micrometer
μg	microgram
q ₁ *	cancer slope factor
-	negative
+	positive
(+)	weakly positive result
(-)	weakly negative result