



Uploaded to VFC Website

▶▶ July 2013 ◀◀

This Document has been provided to you courtesy of Veterans-For-Change!

Feel free to pass to any veteran who might be able to use this information!

For thousands more files like this and hundreds of links to useful information, and hundreds of "Frequently Asked Questions, please go to:

[Veterans-For-Change](http://www.veteransforchange.org)

*Veterans-For-Change is a 501(c)(3) Non-Profit Corporation
Tax ID #27-3820181*

If Veteran's don't help Veteran's, who will?

We appreciate all donations to continue to provide information and services to Veterans and their families.

https://www.paypal.com/cgi-bin/webscr?cmd=_s-xclick&hosted_button_id=WGT2M5UTB9A78

Note:

VFC is not liable for source information in this document, it is merely provided as a courtesy to our members.



TOXICOLOGICAL PROFILE FOR CADMIUM

U.S. DEPARTMENT OF HEALTH AND HUMAN SERVICES
Public Health Service
Agency for Toxic Substances and Disease Registry

September 2012

DISCLAIMER

Use of trade names is for identification only and does not imply endorsement by the Agency for Toxic Substances and Disease Registry, the Public Health Service, or the U.S. Department of Health and Human Services.

UPDATE STATEMENT

A Toxicological Profile for Cadmium, Draft for Public Comment was released in September 2008. This edition supersedes any previously released draft or final profile.

Toxicological profiles are revised and republished as necessary. For information regarding the update status of previously released profiles, contact ATSDR at:

Agency for Toxic Substances and Disease Registry
Division of Toxicology and Human Health Sciences (proposed)
Environmental Toxicology Branch (proposed)
1600 Clifton Road NE
Mailstop F-62
Atlanta, Georgia 30333

This page is intentionally blank.

FOREWORD

This toxicological profile is prepared in accordance with guidelines* developed by the Agency for Toxic Substances and Disease Registry (ATSDR) and the Environmental Protection Agency (EPA). The original guidelines were published in the *Federal Register* on April 17, 1987. Each profile will be revised and republished as necessary.

The ATSDR toxicological profile succinctly characterizes the toxicologic and adverse health effects information for the toxic substances each profile describes. Each peer-reviewed profile identifies and reviews the key literature that describes a substance's toxicologic properties. Other pertinent literature is also presented but is described in less detail than the key studies. The profile is not intended to be an exhaustive document; however, more comprehensive sources of specialty information are referenced.

The profiles focus on health and toxicologic information; therefore, each toxicological profile begins with a public health statement that describes, in nontechnical language, a substance's relevant toxicological properties. Following the public health statement is information concerning levels of significant human exposure and, where known, significant health effects. A health effects summary describes the adequacy of information to determine a substance's health effects. ATSDR identifies data needs that are significant to protection of public health.

Each profile:

- (A) Examines, summarizes, and interprets available toxicologic information and epidemiologic evaluations on a toxic substance to ascertain the levels of significant human exposure for the substance and the associated acute, subacute, and chronic health effects;
- (B) Determines whether adequate information on the health effects of each substance is available or being developed to determine levels of exposure that present a significant risk to human health of acute, subacute, and chronic health effects; and
- (C) Where appropriate, identifies toxicologic testing needed to identify the types or levels of exposure that may present significant risk of adverse health effects in humans.

The principal audiences for the toxicological profiles are federal, state, and local health professionals; interested private sector organizations and groups; and members of the public.

This profile reflects ATSDR's assessment of all relevant toxicologic testing and information that has been peer-reviewed. Staff of the Centers for Disease Control and Prevention and other federal scientists also have reviewed the profile. In addition, this profile has been peer-reviewed by a nongovernmental panel and was made available for public review. Final responsibility for the contents and views expressed in this toxicological profile resides with ATSDR.



Christopher J. Portier, Ph.D.
Assistant Administrator

Agency for Toxic Substances and Disease Registry

*Legislative Background

The toxicological profiles are developed under the Comprehensive Environmental Response, Compensation, and Liability Act of 1980, as amended (CERCLA or Superfund). CERCLA section 104(i)(1) directs the Administrator of ATSDR to "...effectuate and implement the health related authorities" of the statute. This includes the preparation of toxicological profiles for hazardous substances most commonly found at facilities on the CERCLA National Priorities List and that pose the most significant potential threat to human health, as determined by ATSDR and the EPA. Section 104(i)(3) of CERCLA, as amended, directs the Administrator of ATSDR to prepare a toxicological profile for each substance on the list. In addition, ATSDR has the authority to prepare toxicological profiles for substances not found at sites on the National Priorities List, in an effort to "...establish and maintain inventory of literature, research, and studies on the health effects of toxic substances" under CERCLA Section 104(i)(1)(B), to respond to requests for consultation under section 104(i)(4), and as otherwise necessary to support the site-specific response actions conducted by ATSDR.

QUICK REFERENCE FOR HEALTH CARE PROVIDERS

Toxicological Profiles are a unique compilation of toxicological information on a given hazardous substance. Each profile reflects a comprehensive and extensive evaluation, summary, and interpretation of available toxicologic and epidemiologic information on a substance. Health care providers treating patients potentially exposed to hazardous substances will find the following information helpful for fast answers to often-asked questions.

Primary Chapters/Sections of Interest

Chapter 1: Public Health Statement: The Public Health Statement can be a useful tool for educating patients about possible exposure to a hazardous substance. It explains a substance's relevant toxicologic properties in a nontechnical, question-and-answer format, and it includes a review of the general health effects observed following exposure.

Chapter 2: Relevance to Public Health: The Relevance to Public Health Section evaluates, interprets, and assesses the significance of toxicity data to human health.

Chapter 3: Health Effects: Specific health effects of a given hazardous compound are reported by type of health effect (death, systemic, immunologic, reproductive), by route of exposure, and by length of exposure (acute, intermediate, and chronic). In addition, both human and animal studies are reported in this section.

NOTE: Not all health effects reported in this section are necessarily observed in the clinical setting. Please refer to the Public Health Statement to identify general health effects observed following exposure.

Pediatrics: Four new sections have been added to each Toxicological Profile to address child health issues:

Section 1.6 **How Can (Chemical X) Affect Children?**

Section 1.7 **How Can Families Reduce the Risk of Exposure to (Chemical X)?**

Section 3.7 **Children's Susceptibility**

Section 6.6 **Exposures of Children**

Other Sections of Interest:

Section 3.8 **Biomarkers of Exposure and Effect**

Section 3.11 **Methods for Reducing Toxic Effects**

ATSDR Information Center

Phone: 1-800-CDC-INFO (800-232-4636) or 1-888-232-6348 (TTY) **Fax:** (770) 488-4178

E-mail: cdcinfo@cdc.gov

Internet: <http://www.atsdr.cdc.gov>

The following additional material can be ordered through the ATSDR Information Center:

Case Studies in Environmental Medicine: Taking an Exposure History—The importance of taking an exposure history and how to conduct one are described, and an example of a thorough exposure history is provided. Other case studies of interest include *Reproductive and Developmental Hazards*; *Skin Lesions and Environmental Exposures*; *Cholinesterase-Inhibiting Pesticide Toxicity*; and numerous chemical-specific case studies.

Managing Hazardous Materials Incidents is a three-volume set of recommendations for on-scene (prehospital) and hospital medical management of patients exposed during a hazardous materials incident. Volumes I and II are planning guides to assist first responders and hospital emergency department personnel in planning for incidents that involve hazardous materials. Volume III—*Medical Management Guidelines for Acute Chemical Exposures*—is a guide for health care professionals treating patients exposed to hazardous materials.

Fact Sheets (ToxFAQs) provide answers to frequently asked questions about toxic substances.

Other Agencies and Organizations

The National Center for Environmental Health (NCEH) focuses on preventing or controlling disease, injury, and disability related to the interactions between people and their environment outside the workplace. Contact: NCEH, Mailstop F-29, 4770 Buford Highway, NE, Atlanta, GA 30341-3724 • Phone: 770-488-7000 • FAX: 770-488-7015.

The National Institute for Occupational Safety and Health (NIOSH) conducts research on occupational diseases and injuries, responds to requests for assistance by investigating problems of health and safety in the workplace, recommends standards to the Occupational Safety and Health Administration (OSHA) and the Mine Safety and Health Administration (MSHA), and trains professionals in occupational safety and health. Contact: NIOSH, 200 Independence Avenue, SW, Washington, DC 20201 • Phone: 800-356-4674 or NIOSH Technical Information Branch, Robert A. Taft Laboratory, Mailstop C-19, 4676 Columbia Parkway, Cincinnati, OH 45226-1998 • Phone: 800-35-NIOSH.

The National Institute of Environmental Health Sciences (NIEHS) is the principal federal agency for biomedical research on the effects of chemical, physical, and biologic environmental agents on human health and well-being. Contact: NIEHS, PO Box 12233, 104 T.W. Alexander Drive, Research Triangle Park, NC 27709 • Phone: 919-541-3212.

Referrals

The Association of Occupational and Environmental Clinics (AOEC) has developed a network of clinics in the United States to provide expertise in occupational and environmental issues. Contact: AOEC, 1010 Vermont Avenue, NW, #513, Washington, DC 20005 • Phone: 202-347-4976 • FAX: 202-347-4950 • e-mail: AOEC@AOEC.ORG • Web Page: <http://www.aoec.org/>.

The American College of Occupational and Environmental Medicine (ACOEM) is an association of physicians and other health care providers specializing in the field of occupational and environmental medicine. Contact: ACOEM, 25 Northwest Point Boulevard, Suite 700, Elk Grove Village, IL 60007-1030 • Phone: 847-818-1800 • FAX: 847-818-9266.

CONTRIBUTORS

CHEMICAL MANAGER(S)/AUTHOR(S):

Obaid Faroon, Ph.D. DVM
Annette Ashizawa, Ph.D.
Scott Wright, M.S.
Pam Tucker, M.D.
Kim Jenkins, B.A.
ATSDR, Division of Toxicology and Human Health Sciences (proposed), Atlanta, GA

Lisa Ingerman, Ph.D., DABT
Catherine Rudisill, B.S.
SRC Inc. (formerly known as Syracuse Research Corporation), North Syracuse, NY

THE PROFILE HAS UNDERGONE THE FOLLOWING ATSDR INTERNAL REVIEWS:

1. Health Effects Review. The Health Effects Review Committee examines the health effects chapter of each profile for consistency and accuracy in interpreting health effects and classifying end points.
2. Minimal Risk Level Review. The Minimal Risk Level Workgroup considers issues relevant to substance-specific Minimal Risk Levels (MRLs), reviews the health effects database of each profile, and makes recommendations for derivation of MRLs.
3. Data Needs Review. The Environmental Toxicology Branch (proposed) reviews data needs sections to assure consistency across profiles and adherence to instructions in the Guidance.
4. Green Border Review. Green Border review assures the consistency with ATSDR policy.

This page is intentionally blank.

PEER REVIEW

A peer review panel was assembled for cadmium. The panel consisted of the following members:

1. Maryka H. Bhattacharyya, Ph.D., Senior Biochemist, Biosciences Division (BIO), Argonne National Laboratory, Lemont, Illinois 60439,
2. Masayuki Ikeda, Ph.D., M.D., Professor, Kyoto Industrial Health Association, Kyoto, Japan 604-8472, and
3. Zahir A Shaikh, Ph.D., Professor of Pharmacology and Toxicology, Director of the Center for Molecular Toxicology, University of Rhode Island, Kingston, Rhode Island 02881.

These experts collectively have knowledge of cadmium's physical and chemical properties, toxicokinetics, key health end points, mechanisms of action, human and animal exposure, and quantification of risk to humans. All reviewers were selected in conformity with the conditions for peer review specified in Section 104(I)(13) of the Comprehensive Environmental Response, Compensation, and Liability Act, as amended.

Scientists from the Agency for Toxic Substances and Disease Registry (ATSDR) have reviewed the peer reviewers' comments and determined which comments will be included in the profile. A listing of the peer reviewers' comments not incorporated in the profile, with a brief explanation of the rationale for their exclusion, exists as part of the administrative record for this compound.

The citation of the peer review panel should not be understood to imply its approval of the profile's final content. The responsibility for the content of this profile lies with the ATSDR.

This page is intentionally blank.

CONTENTS

DISCLAIMER	ii
UPDATE STATEMENT	iii
FOREWORD	v
QUICK REFERENCE FOR HEALTH CARE PROVIDERS	vii
CONTRIBUTORS	ix
PEER REVIEW	xi
CONTENTS	xiii
LIST OF FIGURES	xvii
LIST OF TABLES	xix
1. PUBLIC HEALTH STATEMENT	1
1.1 WHAT IS CADMIUM?	2
1.2 WHAT HAPPENS TO CADMIUM WHEN IT ENTERS THE ENVIRONMENT?	2
1.3 HOW MIGHT I BE EXPOSED TO CADMIUM?	3
1.4 HOW CAN CADMIUM ENTER AND LEAVE MY BODY?	4
1.5 HOW CAN CADMIUM AFFECT MY HEALTH?	4
1.6 HOW CAN CADMIUM AFFECT CHILDREN?	5
1.7 HOW CAN FAMILIES REDUCE THE RISK OF EXPOSURE TO CADMIUM?	6
1.8 IS THERE A MEDICAL TEST TO DETERMINE WHETHER I HAVE BEEN EXPOSED TO CADMIUM?	7
1.9 WHAT RECOMMENDATIONS HAS THE FEDERAL GOVERNMENT MADE TO PROTECT HUMAN HEALTH?	7
1.10 WHERE CAN I GET MORE INFORMATION?	8
2. RELEVANCE TO PUBLIC HEALTH	11
2.1 BACKGROUND AND ENVIRONMENTAL EXPOSURES TO CADMIUM IN THE UNITED STATES	11
2.2 SUMMARY OF HEALTH EFFECTS	12
2.3 MINIMAL RISK LEVELS (MRLs)	15
3. HEALTH EFFECTS	45
3.1 INTRODUCTION	45
3.2 DISCUSSION OF HEALTH EFFECTS BY ROUTE OF EXPOSURE	45
3.2.1 Inhalation Exposure	47
3.2.1.1 Death	47
3.2.1.2 Systemic Effects	50
3.2.1.3 Immunological and Lymphoreticular Effects	94
3.2.1.4 Neurological Effects	95
3.2.1.5 Reproductive Effects	97
3.2.1.6 Developmental Effects	99
3.2.1.7 Cancer	100
3.2.2 Oral Exposure	105
3.2.2.1 Death	105
3.2.2.2 Systemic Effects	106
3.2.2.3 Immunological and Lymphoreticular Effects	169
3.2.2.4 Neurological Effects	169
3.2.2.5 Reproductive Effects	170
3.2.2.6 Developmental Effects	174
3.2.2.7 Cancer	177

3.2.3	Dermal Exposure.....	181
3.2.3.1	Death.....	181
3.2.3.2	Systemic Effects.....	181
3.2.3.3	Immunological and Lymphoreticular Effects	182
3.2.3.4	Neurological Effects.....	184
3.2.3.5	Reproductive Effects	184
3.2.3.6	Developmental Effects	184
3.2.3.7	Cancer	184
3.3	GENOTOXICITY	184
3.4	TOXICOKINETICS.....	191
3.4.1	Absorption.....	192
3.4.1.1	Inhalation Exposure	192
3.4.1.2	Oral Exposure	193
3.4.1.3	Dermal Exposure	196
3.4.2	Distribution	198
3.4.2.1	Inhalation Exposure	198
3.4.2.2	Oral Exposure	198
3.4.2.3	Dermal Exposure	200
3.4.3	Metabolism.....	200
3.4.4	Elimination and Excretion.....	200
3.4.4.1	Inhalation Exposure	201
3.4.4.2	Oral Exposure	201
3.4.4.3	Dermal Exposure	202
3.4.5	Physiologically Based Pharmacokinetic (PBPK)/Pharmacodynamic (PD) Models	203
3.4.5.1	Summary of Cadmium PBPK Models.....	204
3.4.5.2	Cadmium PBPK Model Comparison.....	204
3.4.5.3	Discussion of Cadmium Models.....	206
3.5	MECHANISMS OF ACTION	216
3.5.1	Pharmacokinetic Mechanisms.....	216
3.5.2	Mechanisms of Toxicity.....	220
3.5.3	Animal-to-Human Extrapolations.....	223
3.6	TOXICITIES MEDIATED THROUGH THE NEUROENDOCRINE AXIS	224
3.7	CHILDREN'S SUSCEPTIBILITY	225
3.8	BIOMARKERS OF EXPOSURE AND EFFECT	230
3.8.1	Biomarkers Used to Identify or Quantify Exposure to Cadmium.....	231
3.8.2	Biomarkers Used to Characterize Effects Caused by Cadmium.....	234
3.9	INTERACTIONS WITH OTHER CHEMICALS	238
3.10	POPULATIONS THAT ARE UNUSUALLY SUSCEPTIBLE	240
3.11	METHODS FOR REDUCING TOXIC EFFECTS.....	241
3.11.1	Reducing Peak Absorption Following Exposure.....	241
3.11.2	Reducing Body Burden	243
3.11.3	Interfering with the Mechanism of Action for Toxic Effects	244
3.12	ADEQUACY OF THE DATABASE.....	246
3.12.1	Existing Information on Health Effects of Cadmium.....	246
3.12.2	Identification of Data Needs.....	248
3.12.3	Ongoing Studies	258
4.	CHEMICAL AND PHYSICAL INFORMATION.....	261
4.1	CHEMICAL IDENTITY.....	261
4.2	PHYSICAL AND CHEMICAL PROPERTIES.....	261

5. PRODUCTION, IMPORT/EXPORT, USE, AND DISPOSAL	267
5.1 PRODUCTION	267
5.2 IMPORT/EXPORT	273
5.3 USE	273
5.4 DISPOSAL	274
6. POTENTIAL FOR HUMAN EXPOSURE	277
6.1 OVERVIEW	277
6.2 RELEASES TO THE ENVIRONMENT	281
6.2.1 Air	282
6.2.2 Water	287
6.2.3 Soil	288
6.3 ENVIRONMENTAL FATE	290
6.3.1 Transport and Partitioning	290
6.3.2 Transformation and Degradation	295
6.3.2.1 Air	295
6.3.2.2 Water	295
6.3.2.3 Sediment and Soil	295
6.4 LEVELS MONITORED OR ESTIMATED IN THE ENVIRONMENT	295
6.4.1 Air	296
6.4.2 Water	297
6.4.3 Sediment and Soil	298
6.4.4 Other Environmental Media	300
6.5 GENERAL POPULATION AND OCCUPATIONAL EXPOSURE	305
6.6 EXPOSURES OF CHILDREN	319
6.7 POPULATIONS WITH POTENTIALLY HIGH EXPOSURES	323
6.8 ADEQUACY OF THE DATABASE	324
6.8.1 Identification of Data Needs	324
6.8.2 Ongoing Studies	328
7. ANALYTICAL METHODS	333
7.1 BIOLOGICAL MATERIALS	333
7.2 ENVIRONMENTAL SAMPLES	335
7.3 ADEQUACY OF THE DATABASE	338
7.3.1 Identification of Data Needs	338
7.3.2 Ongoing Studies	342
8. REGULATIONS, ADVISORIES, AND GUIDELINES	345
9. REFERENCES	351
10. GLOSSARY	425
APPENDICES	
A. ATSDR MINIMAL RISK LEVELS AND WORKSHEETS	A-1
B. USER'S GUIDE	B-1
C. ACRONYMS, ABBREVIATIONS, AND SYMBOLS	C-1
D. INDEX	D-1

This page is intentionally blank.

LIST OF FIGURES

2-1. Combined Chronic Oral Cadmium Intakes ($\mu\text{g}/\text{kg}/\text{day}$) and Inhalation Cadmium Exposures ($\mu\text{g}/\text{m}^3$) that Achieve a Urinary Cadmium Excretion of $0.5 \mu\text{g}/\text{g}$ Creatinine at Age 55 Years Predicted by the Cadmium Pharmacokinetic Model and the International Commission on Radiological Protection (ICRP) Human Respiratory Tract Model	24
2-2. Estimates of the UCD_{10} from Environmental Exposure Dose-Response Studies.....	40
2-3. Urinary Cadmium ($\mu\text{g}/\text{g}$ creatinine) and Renal Cortex Cadmium Concentration ($\mu\text{g}/\text{g}$ wet tissue) Predicted by the Cadmium Pharmacokinetic Model	42
3-1. Levels of Significant Exposure to Cadmium - Inhalation	69
3-2. Levels of Significant Exposure to Cadmium - Oral	131
3-3. Conceptual Representation of a Physiologically Based Pharmacokinetic (PBPK) Model for a Hypothetical Chemical Substance.....	205
3-4. A Schematic Representation of the Nordberg-Kjellström Model.....	207
3-5. A Schematic Representation of the Shank Model	212
3-6. Existing Information on Health Effects of Cadmium.....	247
6-1. Frequency of NPL Sites with Cadmium Contamination	278
6-2. Frequency of NPL Sites with Cadmium Compounds Contamination.....	279

This page is intentionally blank.

LIST OF TABLES

2-1. Summary of Human Studies Finding Dose-Response Relationships Between Biomarkers of Renal Dysfunction and Cadmium Exposure	33
2-2. Selected Benchmark Dose Estimations of Urinary Cadmium Levels Associated with Increases in the Prevalence of Low Molecular Weight Proteinuria.....	36
2-3. Selected Studies of Dose-Response Relationship for Cadmium-Induced Low Molecular Weight Proteinuria.....	39
3-1. Levels of Significant Exposure to Cadmium - Inhalation	51
3-2. Comparison of Lung Effects Across Intermediate-Duration Inhalation Studies	78
3-3. Severity of Respiratory Effects in Rats and Mice Exposed to Cadmium Oxide for 13 Weeks.....	79
3-4. Summary of Occupational Exposure Studies Examining Renal Effects	87
3-5. Guidelines for Interpreting β 2-microglobulin Levels.....	91
3-6. Levels of Significant Exposure to Cadmium - Oral	107
3-7. Summary of Human Studies Examining Renal Effects.....	149
3-8. Benchmark Dose Estimations of Urinary Cadmium Levels ($\mu\text{g/g}$ Creatinine).....	161
3-9. Levels of Significant Exposure to Cadmium - Dermal.....	183
3-10. Genotoxicity of Cadmium <i>In Vivo</i>	185
3-11. Genotoxicity of Cadmium <i>In Vitro</i>	188
3-12. Assumed Model Parameters and Some Physiologic Parameters for the Nordberg-Kjellström Model	208
3-13. Estimated Parameters, Rate of Uptake, Rate Constants, and Biological Half-Lives in Selected Mouse Organs After Subcutaneous and Oral Administrations of $^{109}\text{CdCl}_2$	215
3-14. Ongoing Studies on Cadmium.....	259
4-1. Chemical Identity of Cadmium and Compounds	262
4-2. Physical and Chemical Properties of Cadmium and Compounds	264
5-1. Facilities that Produce, Process, or Use Cadmium	268
5-2. Facilities that Produce, Process, or Use Cadmium Compounds.....	270
6-1. Releases to the Environment from Facilities that Produce, Process, or Use Cadmium.....	283

6-2. Releases to the Environment from Facilities that Produce, Process, or Use Cadmium Compounds	285
6-3. Mean Concentrations of Cadmium for FDA’s Total Diet Study Market Baskets 2006-1 through 2008-4	302
6-4. Geometric Mean and Selected Percentile Blood Concentrations ($\mu\text{g/L}$) of Cadmium in the U.S. Population from 1999 to 2008	306
6-5. Geometric Mean and Selected Percentile Urine Concentrations (Creatinine Corrected) ($\mu\text{g/g}$ Creatinine) of Cadmium in the U.S. Population from 1999 to 2008.....	309
6-6. Geometric Mean and Selected Percentile Urine Concentrations ($\mu\text{g/L}$) of Cadmium in the U.S. Population from 1999 to 2008	312
6-7. Blood Cadmium Concentrations, Geometric Means, Adjusted Proportional Change in Means, and 95th Percentiles in New York City Adults in Population Subgroups.....	316
6-8. Occupations with Potential Exposure to Cadmium and Cadmium Compounds	318
6-9. Estimated Number of Workers Potentially Exposed to Various Chemicals in the Workplace in 1981–1983.....	320
6-10. Ongoing Studies on Cadmium.....	329
7-1. Analytical Methods for Determining Cadmium in Biological Materials	336
7-2. Analytical Methods for Determining Cadmium in Environmental Samples.....	339
7-3. Ongoing Analytical Methods Studies on Cadmium	343
8-1. Regulations, Advisories, and Guidelines Applicable to Cadmium	347

1. PUBLIC HEALTH STATEMENT

This public health statement tells you about cadmium and the effects of exposure to it.

The Environmental Protection Agency (EPA) identifies the most serious hazardous waste sites in the nation. These sites are then placed on the National Priorities List (NPL) and are targeted for long-term federal clean-up activities. Cadmium has been found in at least 1,014 of the 1,669 current or former NPL sites. Although the total number of NPL sites evaluated for this substance is not known, the possibility exists that the number of sites at which cadmium is found may increase in the future as more sites are evaluated. This information is important because these sites may be sources of exposure and exposure to this substance may be harmful.

When a substance is released either from a large area, such as an industrial plant, or from a container, such as a drum or bottle, it enters the environment. Such a release does not always lead to exposure. You can be exposed to a substance only when you come in contact with it. You may be exposed by breathing, eating, or drinking the substance, or by skin contact.

If you are exposed to cadmium or cadmium compounds, many factors will determine whether you will be harmed. These factors include the dose (how much), the duration (how long), and how you come in contact with it. You must also consider any other chemicals you are exposed to and your age, sex, diet, family traits, lifestyle, and state of health.

1. PUBLIC HEALTH STATEMENT

1.1 WHAT IS CADMIUM?

Description	<p>Metal found in the earth's crust, associated with zinc, lead, and copper ores.</p> <p>Pure cadmium is a soft, silver-white metal. Cadmium chloride and cadmium sulfate are soluble in water.</p>
Uses <ul style="list-style-type: none"> • Manufacturing • Consumer products 	<p>Most cadmium used in the United States is extracted as a byproduct during the production of other metals such as zinc, lead, or copper. Cadmium is also recovered from used batteries.</p> <p>Cadmium is used for the following:</p> <ul style="list-style-type: none"> • batteries (83%) • pigments (8%) • coatings and platings (7%) • stabilizers for plastics (1.2%) • nonferrous alloys, photovoltaic devices, and other uses (0.8%)

For more information on the properties and uses of cadmium, see Chapters 4 and 5.

1.2 WHAT HAPPENS TO CADMIUM WHEN IT ENTERS THE ENVIRONMENT?

Sources	<p>Cadmium is emitted to soil, water, and air by non-ferrous metal mining and refining, manufacture and application of phosphate fertilizers, fossil fuel combustion, and waste incineration and disposal.</p> <p>Cadmium can accumulate in aquatic organisms and agricultural crops.</p>
Fate <ul style="list-style-type: none"> • Air • Soil • Water 	<p>Cadmium (as oxide, chloride, and sulfate) will exist in air as particles or vapors (from high temperature processes). It can be transported long distances in the atmosphere, where it will deposit (wet or dry) onto soils and water surfaces.</p> <p>Cadmium and its compounds may travel through soil, but its mobility depends on several factors such as pH and amount of organic matter, which will vary depending on the local environment. Generally, cadmium binds strongly to organic matter where it will be immobile in soil and be taken up by plant life, eventually, entering the food supply.</p> <p>Cadmium exists as the hydrated ion or as ionic complexes with other inorganic or organic substances. Soluble forms migrate in water. Insoluble forms of cadmium are immobile and will deposit and absorb to sediments.</p>

1. PUBLIC HEALTH STATEMENT

1.3 HOW MIGHT I BE EXPOSED TO CADMIUM?

Food and smoking—primary sources of exposure	<p>In the United States, for nonsmokers the primary source of cadmium exposure is from the food supply. In general, leafy vegetables such as lettuce and spinach, potatoes and grains, peanuts, soybeans, and sunflower seeds contain high levels of cadmium, approximately 0.05–0.12 mg cadmium/kg.</p> <p>Tobacco leaves accumulate high levels of cadmium from the soil.</p> <p>The national geometric mean blood cadmium level for adults is 0.38 µg/L. A geometric mean blood cadmium level of 1.58 µg/L for New York City smokers has been reported. The amount of cadmium absorbed from smoking one pack of cigarettes per day is about 1–3 µg/day. Direct measurement of cadmium levels in body tissues confirms that smoking roughly doubles cadmium body burden in comparison to not smoking.</p>
Air	<p>Except for people living near cadmium-emitting industries, inhalation of cadmium is not expected to be a major concern.</p>
Water	<p>Elevated cadmium levels in water sources in the vicinity of cadmium-emitting industries (historical and current) have been reported. Aquatic organisms will accumulate cadmium, possibly entering the food supply. People who fish in local waters as a means of food should be cautious and abide by any advisories.</p>
Occupational exposure	<p>Highest risk of exposure from processes involving heating cadmium-containing materials such as smelting and electroplating. Risk will vary depending on the workplace.</p> <p>Major route of exposure is through inhalation of dust and fumes or incidental ingestion from contaminated hands, food, or cigarettes.</p> <p>Exposure can be controlled through personal protective equipment, good industrial hygiene practices, and control and reduction of cadmium emissions.</p>

In Chapter 6, you can find more information on how you might be exposed to cadmium.

1. PUBLIC HEALTH STATEMENT

1.4 HOW CAN CADMIUM ENTER AND LEAVE MY BODY?

<p>Enter your body</p> <ul style="list-style-type: none"> • Inhalation • Ingestion • Dermal contact 	<p>About 5–50% of the cadmium you breathe will enter your body through your lungs.</p> <p>A small amount of the cadmium in food and water (about 1–10%) will enter your body through the digestive tract. If you do not have enough iron or other nutrients in your diet, you are likely to take up more cadmium from your food than usual.</p> <p>Virtually no cadmium enters your body through your skin.</p>
<p>Leave your body</p>	<p>Most of the cadmium that enters your body goes to your kidney and liver and can remain there for many years. A small portion of the cadmium that enters your body leaves slowly in urine and feces.</p> <p>Your body can change most cadmium to a form that is not harmful, but too much cadmium can overload the ability of your liver and kidney to change the cadmium to a harmless form.</p>

More information on how cadmium enters and leaves the body is found in Chapter 3.

1.5 HOW CAN CADMIUM AFFECT MY HEALTH?

This section looks at studies concerning potential health effects in animal and human studies.

<p>Workers</p> <ul style="list-style-type: none"> • Inhalation 	<p>Breathing air with very high levels of cadmium can severely damage the lungs and may cause death.</p> <p>Breathing air with lower levels of cadmium over long periods of time (for years) results in a build-up of cadmium in the kidney, and if sufficiently high, may result in kidney disease.</p>
<p>Laboratory animals</p> <ul style="list-style-type: none"> • Inhalation 	<p>Damage to the lungs and nasal cavity has been observed in animals exposed to cadmium.</p>

1. PUBLIC HEALTH STATEMENT

Humans • Oral	<p>Eating food or drinking water with very high cadmium levels severely irritates the stomach, leading to vomiting and diarrhea, and sometimes death.</p> <p>Eating lower levels of cadmium over a long period of time can lead to a build-up of cadmium in the kidneys. If the build-up of cadmium is high enough, it will damage the kidneys.</p> <p>Exposure to lower levels of cadmium for a long time can also cause bones to become fragile and break easily.</p>
Laboratory animals • Oral	<p>Kidney and bone effects have also been observed in laboratory animals ingesting cadmium.</p> <p>Anemia, liver disease, and nerve or brain damage have been observed in animals eating or drinking cadmium. We have no good information on people to indicate what cadmium levels people would need to eat or drink to result in these diseases, or if they would occur at all.</p>
Cancer	<p>Lung cancer has been found in some studies of workers exposed to cadmium in the air and studies of rats that breathed in cadmium.</p> <p>The U.S. Department of Health and Human Services (DHHS) has determined that cadmium and cadmium compounds are known human carcinogens. The International Agency for Research on Cancer (IARC) has determined that cadmium is carcinogenic to humans. The EPA has determined that cadmium is a probable human carcinogen.</p>

More information on how cadmium can affect your health is found in Chapters 2 and 3.

1.6 HOW CAN CADMIUM AFFECT CHILDREN?

This section discusses potential health effects in humans from exposures during the period from conception to maturity at 18 years of age.

1. PUBLIC HEALTH STATEMENT

<p>Effects in children</p>	<p>The health effects seen in children from exposure to toxic levels of cadmium are expected to be similar to the effects seen in adults (kidney and lung damage).</p> <p>Harmful effects on child development or behavior have not generally been seen in populations exposed to cadmium, but more research is needed.</p> <p>A few studies in animals indicate that younger animals absorb more cadmium than adults. Animal studies also indicate that the young are more susceptible than adults to a loss of bone and decreased bone strength from exposure to cadmium.</p> <p>Cadmium is found in breast milk and a small amount will enter the infant's body through breastfeeding. The amount of cadmium that can pass to the infant depends on how much exposure the mother may have had.</p>
<p>Birth defects</p>	<p>We do not know whether cadmium can cause birth defects in people.</p> <p>Studies in animals exposed to high enough levels of cadmium during pregnancy have resulted in harmful effects in the young. The nervous system appears to be the most sensitive target. Young animals exposed to cadmium before birth have shown effects on behavior and learning. There is also some information from animal studies that high enough exposures to cadmium before birth can reduce body weights and affect the skeleton in the developing young.</p>

1.7 HOW CAN FAMILIES REDUCE THE RISK OF EXPOSURE TO CADMIUM?

<p>Do not smoke tobacco products</p>	<p>Cadmium accumulates in tobacco leaves. The national geometric mean blood cadmium level for adults is 0.376 µg/L. Mean blood cadmium levels for heavy smokers have been reported as high as 1.58 µg/L.</p>
<p>Good occupational hygiene</p>	<p>Occupational exposure can be controlled through personal protective equipment, good industrial hygiene practices, and control and reduction of cadmium emissions.</p> <p>Children can be exposed to cadmium through parents who work in cadmium-emitting industries. Therefore, good hygiene practices such as bathing and changing clothes before returning home may help reduce the cadmium transported from the job to the home.</p>
<p>Avoid cadmium contaminated areas and food</p>	<p>Check and obey local fishing advisories before consuming fish or shellfish from local waterways.</p> <p>Avoid hazardous waste sites.</p>

1. PUBLIC HEALTH STATEMENT

Proper disposal of cadmium-containing products	<p>Dispose of nickel-cadmium batteries properly. Many states have laws in effect that ban the disposal of batteries as municipal waste. Recycle old batteries whenever possible.</p> <p>Contact your local waste and recycling authority on how to properly dispose of paints and coatings.</p>
Handle properly	<p>Do not allow children to play with batteries. If mishandled, batteries could rupture.</p> <p>Children may also swallow small nickel-cadmium batteries.</p>

If your doctor finds that you have been exposed to significant amounts of cadmium, ask whether your children might also be exposed. Your doctor might need to ask your state health department to investigate.

1.8 IS THERE A MEDICAL TEST TO DETERMINE WHETHER I HAVE BEEN EXPOSED TO CADMIUM?

Detecting exposure	<p>Cadmium can be measured in blood, urine, hair, or nails. Urinary cadmium has been shown to accurately reflect the amount of cadmium in the body.</p>
Measuring exposure	<p>The amount of cadmium in your blood shows your recent exposure to cadmium. The amount of cadmium in your urine shows both your recent and your past exposure.</p> <p>Cadmium levels in hair or nails are not as useful as an indication of when or how much cadmium you may have taken in, partly because cadmium from outside of your body may attach to the hair or nails.</p> <p>Tests are also available to measure the amount of cadmium inside your liver and kidneys.</p>

More information on how cadmium can be measured in exposed humans is presented in Chapters 3 and 7.

1.9 WHAT RECOMMENDATIONS HAS THE FEDERAL GOVERNMENT MADE TO PROTECT HUMAN HEALTH?

The federal government develops regulations and recommendations to protect public health. Regulations can be enforced by law. The EPA, the Occupational Safety and Health Administration (OSHA), and the Food and Drug Administration (FDA) are some federal agencies that develop regulations for toxic substances. Recommendations provide valuable guidelines to protect public health, but cannot be enforced by law. The Agency for Toxic Substances and Disease Registry (ATSDR) and the National

1. PUBLIC HEALTH STATEMENT

Institute for Occupational Safety and Health (NIOSH) are two federal organizations that develop recommendations for toxic substances.

Regulations and recommendations can be expressed as “not-to-exceed” levels. These are levels of a toxic substance in air, water, soil, or food that do not exceed a critical value. This critical value is usually based on levels that affect animals; they are then adjusted to levels that will help protect humans. Sometimes these not-to-exceed levels differ among federal organizations because they used different exposure times (an 8-hour workday or a 24-hour day), different animal studies, or other factors.

Recommendations and regulations are also updated periodically as more information becomes available. For the most current information, check with the federal agency or organization that provides it.

Recommendations and regulations are also updated periodically as more information becomes available. For the most current information, check with the federal agency or organization that provides it. Some regulations and recommendations for cadmium include the following:

Drinking water	The EPA has determined that exposure to cadmium in drinking water at a concentration of 0.04 mg/L for up to 10 days is not expected to cause any adverse effects in a child. The EPA has determined that lifetime exposure to 0.005 mg/L cadmium in drinking water is not expected to cause any adverse effects.
Consumer products	The FDA has determined that cadmium levels in bottled water should not exceed 0.005 mg/L.
Workplace air	OSHA set a legal limit of 5 $\mu\text{g}/\text{m}^3$ cadmium in air averaged over an 8-hour work day.

More information on governmental rules regarding cadmium can be found in Chapter 8.

1.10 WHERE CAN I GET MORE INFORMATION?

If you have any more questions or concerns, please contact your community or state health or environmental quality department, or contact ATSDR at the address and phone number below.

1. PUBLIC HEALTH STATEMENT

ATSDR can also tell you the location of occupational and environmental health clinics. These clinics specialize in recognizing, evaluating, and treating illnesses that result from exposure to hazardous substances.

Toxicological profiles are also available on-line at www.atsdr.cdc.gov and on CD-ROM. You may request a copy of the ATSDR ToxProfiles™ CD-ROM by calling the toll-free information and technical assistance number at 1-800-CDCINFO (1-800-232-4636), by e-mail at cdcinfo@cdc.gov, or by writing to:

Agency for Toxic Substances and Disease Registry
Division of Toxicology and Human Health Sciences (proposed)
1600 Clifton Road NE
Mailstop F-62
Atlanta, GA 30333
Fax: 1-770-488-4178

Organizations for-profit may request copies of final Toxicological Profiles from the following:

National Technical Information Service (NTIS)
5285 Port Royal Road
Springfield, VA 22161
Phone: 1-800-553-6847 or 1-703-605-6000
Web site: <http://www.ntis.gov/>

1. PUBLIC HEALTH STATEMENT

This page is intentionally blank.

2. RELEVANCE TO PUBLIC HEALTH

2.1 BACKGROUND AND ENVIRONMENTAL EXPOSURES TO CADMIUM IN THE UNITED STATES

Cadmium occurs in the earth's crust at a concentration of 0.1–0.5 ppm and is commonly associated with zinc, lead, and copper ores. It is also a natural constituent of ocean water with average levels between <5 and 110 ng/L, with higher levels reported near coastal areas and in marine phosphates and phosphorites. The cadmium concentration of natural surface water and groundwater is usually <1 µg/L. Surface soil concentrations will depend on several factors such as its mobility, natural geochemistry, and magnitude of contamination from sources such as fertilizers and atmospheric deposition. Natural emissions of cadmium to the environment can result from volcanic eruptions, forest fires, generation of sea salt aerosols, or other natural phenomena.

In the environment, cadmium exists in only one oxidation state (+2) and does not undergo oxidation-reduction reactions. In surface water and groundwater, cadmium can exist as the hydrated ion or as ionic complexes with other inorganic or organic substances. Soluble forms of cadmium can migrate in water. Insoluble forms of cadmium will settle and adsorb to sediments. Cadmium's fate in soil depends on several factors such as pH of the soil and the availability of organic matter. Generally, cadmium will bind strongly to organic matter and this will, for the most part, immobilize it. However, cadmium's behavior in soil will vary depending on the environmental conditions. It is not likely that cadmium will undergo significant transformation in the atmosphere. It will exist in particulate form and sometimes vapor form (emitted from high temperature processes) where it will undergo atmospheric transport and eventually deposit onto soils and surface waters.

Non-ferrous metal mining and refining, manufacture and application of phosphate fertilizers, fossil fuel combustion, and waste incineration and disposal are the main anthropogenic sources of cadmium in the environment. Except for those who live near cadmium-emitting industries, inhalation of cadmium in the ambient air may occur, but is not a major source of exposure. Water sources near cadmium-emitting industries, both with historic and current operations, have shown a marked elevation of cadmium in water sediments and aquatic organisms. Concentrations of cadmium in these polluted waters have ranged from <1.0 to 77 µg/L. For the U.S. population, cadmium exposure through the drinking water supply is of minor concern. Cadmium from polluted soil and water can accumulate in plants and organisms, thus entering the food supply.

2. RELEVANCE TO PUBLIC HEALTH

In the United States, the largest source of cadmium exposure for nonsmoking adults and children is through dietary intake. The estimated daily intakes of cadmium in nonsmoking adult males and females living in the United States are 0.35 and 0.30 $\mu\text{g Cd/kg/day}$, respectively. Females generally absorb greater amounts of cadmium in the gastrointestinal tract. In general, leafy vegetables such as lettuce and spinach and staples such as potatoes and grains contain relatively high values of cadmium. Peanuts, soybeans, and sunflower seeds have naturally high levels of cadmium. People who regularly consume shellfish and organ meats (liver and kidney) have increased cadmium exposure.

Mean values of cadmium in the blood and urine of the U.S. population were reported in the National Health and Nutrition Examination Survey (NHANES) 1999–2008. Blood cadmium tends to reflect recent exposures and urinary cadmium reflects cumulative cadmium exposure and body burden (particularly, kidney cadmium levels). The 20 years or older age group had geometric mean levels of blood and urine cadmium that were slightly higher than the younger age groups (0.376 $\mu\text{g/L}$ in blood and 0.232 $\mu\text{g/L}$ in urine). Females (0.331 $\mu\text{g/L}$ in blood and 0.191 $\mu\text{g/L}$ in urine) had slightly higher blood and urine cadmium levels than males (0.299 $\mu\text{g/L}$ in blood and 0.179 $\mu\text{g/L}$ in urine).

Smoking greatly increases exposure to cadmium, as tobacco leaves naturally accumulate high amounts of cadmium. It has been estimated that tobacco smokers are exposed to 1.7 μg cadmium per cigarette, and about 10% is inhaled when smoked. A geometric mean blood cadmium level for a heavy smoker has been reported as high as 1.58 $\mu\text{g/L}$, compared to the estimated national mean of 0.38 $\mu\text{g/L}$ for all adults. Nonsmokers may also be exposed to cadmium in cigarettes via second-hand smoke.

2.2 SUMMARY OF HEALTH EFFECTS

Since the early 1950s, when the hazards of occupational cadmium exposure were recognized, a large amount of information has been generated concerning the toxic effects of cadmium exposure in humans and laboratory animals. Toxicological properties of cadmium are similar for the several different salts and oxides of cadmium that have been investigated, although differences in absorption and distribution lead to different effect levels. For inhalation exposure, particle size and solubility in biological fluids (in contrast to solubility in water) appear to be the more important determinants of the toxicokinetics. For oral exposure, most experimental studies have used soluble cadmium, which exists as the Cd^{+2} ion regardless of the initial salt. Absorption appears to be similar for cadmium ion and cadmium complexed with proteins in food, except for a few specific types of foods such as Bluff oysters and seal meat. Also, poorly soluble cadmium pigments may be absorbed to a lesser extent than soluble cadmium ion. For the

2. RELEVANCE TO PUBLIC HEALTH

general population, dietary exposure to cadmium is the most likely route of exposure. There is an extensive database on the toxicity of cadmium in environmentally exposed populations and in cadmium workers; however, most of these studies were focused on the presumed sensitive targets. These sensitive targets of cadmium toxicity are the kidney and bone following oral exposure and kidney and lung following inhalation exposure. Studies in animals support the identification of these sensitive targets and provide some suggestive evidence that the developing organisms may also be a sensitive target. There is also evidence to suggest that cadmium is a human carcinogen. Other effects that have been observed in humans and/or animals include reproductive toxicity, hepatic effects, hematological effects, and immunological effects.

The earliest indication of kidney damage in humans is an increased excretion of low molecular weight proteins, particularly β 2-microglobulin, human complex forming glycoprotein (pHC) (also referred to as α 1-microglobulin), and retinol binding protein; increased urinary levels of intracellular enzymes such as N-acetyl- β -glucosaminidase (NAG); and increased excretion of calcium and metallothione. Numerous studies of cadmium workers and populations living in areas with low, moderate, or high cadmium pollution have found significant associations between urinary cadmium levels and biomarker levels or significant increases in the prevalence of abnormal biomarker levels. At higher exposure levels, decreases in glomerular filtration rate, increased risk of renal replacement therapy (dialysis or kidney transplantation), and significant increases in the risk of deaths from renal disease have been observed. The sensitivity of the kidney to cadmium is related to its distribution in the body and *de novo* synthesis of metallothionein in the kidney. In the blood, cadmium is bound to metallothionein and is readily filtered at the glomerulus and reabsorbed in the proximal tubule. Within the tubular cells, the metallothionein is degraded in lysosomes and free cadmium is released; the synthesis of endogenous metallothionein by the tubular cells is then stimulated. However, when the total cadmium content in the renal cortex reaches between 50 and 300 $\mu\text{g/g}$ wet weight, the amount of cadmium not bound to metallothionein becomes sufficiently high to cause tubular damage. Free cadmium ions may inactivate metal-dependent enzymes, activate calmodulin, and/or damage cell membranes through activation of oxygen species. Because the toxicity of cadmium is dependent on its concentration in the kidney, adverse effects in humans are typically not observed after shorter durations.

Acute inhalation exposure to cadmium at concentrations above about 5 mg/m^3 may cause destruction of lung epithelial cells, resulting in pulmonary edema, tracheobronchitis, and pneumonitis in both humans and animals. A single, high-level cadmium exposure can result in long-term impairment of lung function. At the cellular level, catalase, superoxide dismutase, non-protein sulfhydryl, glucose-6-phosphate

2. RELEVANCE TO PUBLIC HEALTH

dehydrogenase, and glutathione peroxidase are decreased in response to cadmium lung insults. The respiratory response to cadmium is similar to the response seen with other agents that produce oxidative damage. There typically is an alveolar pneumocyte type 2 cell hyperplasia in response to type 1 cell damage and necrosis. Longer-term inhalation exposure at lower levels also leads to decreased lung function and emphysema in cadmium workers. Some tolerance to cadmium-induced lung irritation develops in exposed humans and animals, and respiratory function may recover after cessation of cadmium exposure. Another effect of long-term inhalation cadmium exposure is damage to the olfactory function and nasal epithelium. Lung damage has also been seen in a few studies of oral cadmium exposure in rats, but the lung effects are likely to be related to liver or kidney damage and subsequent changes in cellular metabolism.

Prolonged inhalation or ingestion exposure of humans to cadmium at levels causing renal dysfunction can lead to painful and debilitating bone disease in individuals with risk factors such as poor nutrition; the occurrence of these bone effects in elderly Japanese women exposed to high levels of cadmium in rice and water was referred to as Itai-Itai disease. Decreases in bone mineral density, increases in the risk of fractures, and increases in the risk of osteoporosis have also been observed in populations living in cadmium-polluted areas. An association between bone effects and cadmium exposure has also been observed in populations exposed to higher levels of cadmium, but not living in cadmium polluted areas. Similar effects have also been observed in young rats orally exposed to cadmium. Animal data strongly suggest that cadmium exposure results in increases in bone turnover and decreases in mineralization during the period of rapid bone growth. Although animal studies suggest that these effects are due to direct damage to the bone, it is likely that renal damage resulting in the loss of calcium and phosphate and alteration in renal metabolism of vitamin D would compound these effects.

There are few human data on developmental effects from exposure to cadmium. Some studies indicate that maternal cadmium exposure may cause decreased birth weight in humans, but most of these studies are of limited use because of weaknesses in the study design and lack of control for confounding factors. A number of other studies did not find a significant relationship between maternal cadmium levels and newborn body weight. In animals, cadmium has been shown to be a developmental toxin by the inhalation, oral, and parenteral routes. Decreased fetal weight, skeletal malformations, and delayed ossification are produced by relatively high maternal doses (1–20 mg/kg/day) due to placental toxicity, interference with fetal metabolism, and damage to the maternal liver. Neurodevelopmental effects have been observed at lower doses. Impaired performance on neurobehavioral tests were observed in the offspring of rats exposed to 0.02 mg/m³ or ≥ 0.04 mg/kg/day.

2. RELEVANCE TO PUBLIC HEALTH

The results of occupational exposure studies examining the possible association between cadmium exposure and an increased risk of lung cancer are inconsistent, with some studies finding significant increases in lung cancer deaths and other studies not finding increases. Interpretation of the results of many of the studies is complicated by inadequate controls for confounding factors such as co-exposure with other metal carcinogens and smoking, small number of lung cancer deaths, and the lack of significant relationships between cadmium exposure and duration. For prostate cancer, initial studies in European workers indicated an elevation in prostate cancer, but subsequent investigations found either no increases in prostate cancer or increases that were not statistically significant. Strong evidence from animal studies exists that cadmium inhalation can cause lung cancer, but only in rats. Most oral studies in laboratory animals have not found significant increases in cancer incidence. The Department of Health and Human Services concluded that there were sufficient human and animal data to conclude that cadmium is a known human carcinogen; likewise, IARC classified cadmium as carcinogenic to humans (Group 1). The EPA has classified cadmium as a probable human carcinogen by inhalation (Group B1), based on its assessment of limited evidence of an increase in lung cancer in humans and sufficient evidence of lung cancer in rats.

2.3 MINIMAL RISK LEVELS (MRLs)

Estimates of exposure levels posing minimal risk to humans (MRLs) have been made for cadmium. An MRL is defined as an estimate of daily human exposure to a substance that is likely to be without an appreciable risk of adverse effects (noncarcinogenic) over a specified duration of exposure. MRLs are derived when reliable and sufficient data exist to identify the target organ(s) of effect or the most sensitive health effect(s) for a specific duration within a given route of exposure. MRLs are based on noncancerous health effects only and do not consider carcinogenic effects. MRLs can be derived for acute, intermediate, and chronic duration exposures for inhalation and oral routes. Appropriate methodology does not exist to develop MRLs for dermal exposure.

Although methods have been established to derive these levels (Barnes and Dourson 1988; EPA 1990d), uncertainties are associated with these techniques. Furthermore, ATSDR acknowledges additional uncertainties inherent in the application of the procedures to derive less than lifetime MRLs. As an example, acute inhalation MRLs may not be protective for health effects that are delayed in development or are acquired following repeated acute insults, such as hypersensitivity reactions, asthma, or chronic

2. RELEVANCE TO PUBLIC HEALTH

bronchitis. As these kinds of health effects data become available and methods to assess levels of significant human exposure improve, these MRLs will be revised.

The database on the toxicity of cadmium in humans and animals following inhalation or oral exposure is extensive. Target organs are similar among species and, in general, toxicokinetic properties after oral and inhalation exposures are similar. Most of the human data involve chronic inhalation exposure of workers or chronic dietary exposure of the general population or populations living in cadmium-polluted areas. Several approaches for characterizing cadmium exposure have been used in these studies. Occupational exposure studies have used current air concentrations or have estimated cumulative exposure based on historical and current monitoring data. Some epidemiology studies have estimated cumulative intake based on the levels of cadmium in rice, in populations where rice has been the dominant source of oral exposure to cadmium. However, most studies (particularly oral studies) have used urinary cadmium levels as a biomarker of exposure. As discussed in greater detail in Section 3.8.1, urinary cadmium levels correlate with cadmium body burden and cadmium concentration in kidney (a critical target organ for chronic exposure). The relationship between renal and urinary cadmium appears to be nearly linear at chronic intakes and kidney burdens that do not produce nephrotoxicity (i.e., elimination half-time is independent of dose). However, at high kidney cadmium burdens, associated with renal damage ($>50 \mu\text{g Cd/g cortex}$), the elimination half-time increases with increasing severity of renal damage. Linearity in the dose-urinary excretion relationship also does not appear to apply following an acute high exposure to cadmium. The Nordberg-Kjellström model (described in detail in Section 3.4.5.3) is a multicompartiment pharmacokinetic model that can be used to estimate cadmium intakes (inhalation and oral exposure) associated with a given urinary cadmium level and/or kidney cadmium burden. The model has been extensively evaluated for predicting dose-kidney-urinary cadmium relationships within the linear range of the dose-urinary cadmium relationship.

Inhalation MRLs***Acute-Duration Inhalation MRL***

- [An MRL of \$3 \times 10^{-5} \text{ mg Cd/m}^3\$ \(\$0.03 \mu\text{g Cd/m}^3\$ \) has been derived for acute-duration inhalation exposure \(<14 days\) to cadmium.](#)

The acute toxicity of airborne cadmium, particularly cadmium oxide fumes, was first recognized in the early 1920s and there have been numerous case reports of cadmium workers dying after brief exposures to presumably high concentrations of cadmium fumes (European Chemicals Bureau 2007). The initial

2. RELEVANCE TO PUBLIC HEALTH

symptoms, similar to those observed in metal fume fever, are usually mild but rapidly progress to severe pulmonary edema and chemical pneumonitis. Persistent respiratory effects (often lasting years after the exposure) have been reported in workers surviving these initial effects. There are limited monitoring data for these human reports; however, Elinder (1986b) estimated that an 8-hour exposure to 1–5 mg/m³ would be immediately dangerous.

Animal studies support the findings in humans that acute exposure to cadmium results in lung damage. Single exposures to approximately 1–10 mg Cd/m³ as cadmium chloride or cadmium oxide resulted in interstitial pneumonitis, diffuse alveolitis with hemorrhage, focal interstitial thickening, and edema (Boudreau et al. 1989; Buckley and Bassett 1987b; Bus et al. 1978; Grose et al. 1987; Hart 1986; Henderson et al. 1979; Palmer et al. 1986). Repeated exposure to 6.1 mg Cd/m³ 1 hour/day for 5, 10, or 15 days resulted in emphysema in rats (Snider et al. 1973). Lower concentrations of 0.4–0.5 mg Cd/m³ as cadmium oxide for 2–3 hours (Buckley and Bassett 1987b; Grose et al. 1987) or 0.17 mg Cd/m³ as cadmium chloride 6 hours/day for 10 days (Klimisch 1993) resulted in mild hypercellularity and increases in lung weight. Alveolar histiocytic infiltration and focal inflammation and minimal fibrosis in alveolar septa were observed in rats exposed to 0.088 mg Cd/m³ as cadmium oxide 6.2 hours/day, 5 days/week for 2 weeks (NTP 1995); in similarly exposed mice, histiocytic infiltration was observed at 0.088 mg Cd/m³ (NTP 1995). At similar concentrations (0.19 or 0.88 mg Cd/m³ as cadmium chloride), decreases in humoral immune response were observed in mice exposed for 1–2 hours (Graham et al. 1978; Krzystyniak et al. 1987). Other effects that have been reported in animals acutely exposed to cadmium include erosion of the stomach, decreased body weight gain, and tremors in rats exposed to 132 mg Cd/m³ as cadmium carbonate for 2 hours (Rusch et al. 1986) and weight loss and reduced activity in rats exposed to 112 mg Cd/m³ as cadmium oxide for 2 hours (Rusch et al. 1986).

The NTP (1995) study was selected as the basis of an acute duration inhalation MRL. In this study, groups of five male and five female F344 rats were exposed to 0, 0.1, 0.3, 1, 3, or 10 mg cadmium oxide/m³ (0, 0.088, 0.26, 0.88, 2.6, or 8.8 mg Cd/m³) 6.2 hours/day, 5 days/week for 2 weeks. The mean median aerodynamic diameter (MMAD) of the cadmium oxide particles was 1.5 µm with a geometric standard deviation of 1.6–1.8. The animals were observed twice daily and weighed on days 1, 8, and at termination. Other parameters used to assess toxicity included organ weights (heart, kidney, liver, lungs, spleen, testis, and thymus) and histopathological examination (gross lesions, heart, kidney, liver, lungs, tracheobronchial lymph nodes, and nasal cavity and turbinates). All rats in the 8.8 mg Cd/m³ group died by day 6; no other deaths occurred. A slight decrease in terminal body weights was observed at 2.6 mg Cd/m³; however, the body weights were within 10% of control weights. Significant increases in relative

2. RELEVANCE TO PUBLIC HEALTH

and absolute lung weights were observed at 0.26 (males only), 0.88, and 2.6 mg Cd/m³. Histological alterations were limited to the respiratory tract and consisted of alveolar histiocytic infiltrate and focal inflammation and minimal fibrosis in alveolar septa at ≥ 0.088 mg Cd/m³, necrosis of the epithelium lining alveolar ducts at ≥ 0.26 mg Cd/m³, tracheobronchial lymph node inflammation at ≥ 0.88 mg Cd/m³, degeneration of the nasal olfactory epithelium at 0.88 mg Cd/m³, and inflammation and metaplasia of the nasal respiratory epithelium at 2.6 mg Cd/m³.

The lowest-observed-adverse-effect level (LOAEL) of 0.088 mg Cd/m³ was selected as the point of departure for derivation of the MRL; benchmark dose analysis was considered; however, the data were not suitable for benchmark dose analysis because the data do not provide sufficient information about the shape of the dose-response relationship below the 100% response level. The LOAEL_{HEC} was calculated using the equations below.

$$\text{LOAEL}_{\text{HEC}} = \text{LOAEL}_{\text{ADJ}} \times \text{RDDR}$$

The duration-adjusted LOAEL (LOAEL_{ADJ}) was calculated as follows:

$$\begin{aligned} \text{LOAEL}_{\text{ADJ}} &= 0.088 \text{ mg Cd/m}^3 \times 6.2 \text{ hours/24 hours} \times 5 \text{ days/7 days} \\ \text{LOAEL}_{\text{ADJ}} &= 0.016 \text{ mg Cd/m}^3 \end{aligned}$$

The regional deposited dose ratio (RDDR) for the pulmonary region of 0.617 was calculated with EPA's RDDR calculator (EPA 1994a) using the final body weight of 0.194 kg for the male rats exposed to 0.088 mg Cd/m³, the reported MMAD of 1.5 μm and the midpoint of the reported range of geometric standard deviations (1.7).

$$\begin{aligned} \text{LOAEL}_{\text{HEC}} &= 0.016 \text{ mg Cd/m}^3 \times 0.617 \\ \text{LOAEL}_{\text{HEC}} &= 0.01 \text{ mg Cd/m}^3 \end{aligned}$$

The LOAEL_{HEC} was divided by an uncertainty factor of 300 (10 for the use of a LOAEL, 3 for extrapolation from animals to humans with dosimetric adjustments, and 10 for human variability) resulting in an acute-duration inhalation MRL of 3×10^{-5} mg Cd/m³ (0.03 $\mu\text{g Cd/m}^3$).

2. RELEVANCE TO PUBLIC HEALTH

Intermediate-Duration Inhalation MRL

There are no studies examining the intermediate-duration toxicity of inhaled cadmium in humans; however, numerous animal studies have identified several targets of cadmium toxicity. Increases in the number of bronchioalveolar macrophages, alveolar histiocytic infiltration, degeneration or metaplasia in the larynx, and proliferations have been observed in rats and mice exposed to 0.022 mg Cd/m³ as cadmium oxide or cadmium chloride (Glaser et al. 1986; NTP 1995; Prigge 1978a). At higher concentrations (>0.88 mg Cd/m³), marked inflammation and fibrosis was observed in lungs of rats (Kutzman et al. 1986; NTP 1995). In general, these studies did not identify no-observed-adverse-effect levels (NOAELs) for lung effects. The NTP (1995) study also found significant increases in the incidence of inflammation of the nasal respiratory epithelium in rats exposed to 0.22 mg Cd/m³ and degeneration of the nasal olfactory epithelium in mice exposed to 0.088 mg Cd/m³. The NTP (1995) study did not find any histological alterations in non-respiratory tract tissues, alterations in urinalysis parameters, or changes in blood pressure (rats only) in rats or mice. Prigge (1978a, 1978b) reported increases in hemoglobin and hematocrit levels in rats continuously exposed to ≥ 0.052 mg Cd/m³; however, this effect was not observed in the NTP (1995) studies. Reproductive effects (increased duration of estrous cycle and decreased spermatid counts) have also been observed at higher concentrations (0.88–1 mg Cd/m³) (Baranski and Sitarek 1987; NTP 1995).

The studies by Baranski (1984, 1985) provide suggestive evidence that the developing organism is also a sensitive target of cadmium toxicity. Significant alterations in performance on neurobehavioral tests were observed in the offspring of rats exposed to 0.02 mg Cd/m³ as cadmium oxide 5 hours/day, 5 days/week for 5 months prior to mating, during a 3-week mating period, and during gestation days 1–20. No other studies examined neurodevelopmental end points following inhalation exposure. However, the identification of neurodevelopmental effects as a sensitive target of cadmium toxicity is supported by several intermediate-duration animal studies finding neurodevelopmental effects including alterations in motor activity and delays in the development of sensory motor coordination reflexes (Ali et al. 1986; Baranski 1985; Desi et al. 1998; Nagymajtenyi et al. 1997). Other developmental effects observed in the inhalation studies included decreases in fetal body weight in the fetuses of rats exposed to 1.7 or 0.581 mg Cd/m³ (NTP 1995; Prigge 1978b) and mice exposed to 0.4 mg Cd/m³ (NTP 1995).

Based on the available animal data, the LOAEL of 0.022 mg Cd/m³ for lung and larynx effects in mice (NTP 1995) and the LOAEL of 0.02 mg Cd/m³ for neurodevelopmental effects (Baranski 1984, 1985) were evaluated as possible points of departure for the intermediate-duration inhalation MRL for cadmium.

2. RELEVANCE TO PUBLIC HEALTH

The LOAEL of 0.022 mg Cd/m³ identified in the NTP (1995) mouse study was considered as the point of departure for the MRL because the NTP study provided more study details and information on particle size distribution. Because an MRL based on this LOAEL (LOAEL_{HEC} of 1 µg Cd/m³) would be lower than the chronic-duration inhalation MRL based on human data, an intermediate-duration inhalation MRL was not derived.

Chronic-Duration Inhalation MRL

- An MRL of 0.01 µg Cd/m³ has been derived for chronic-duration inhalation exposure (≥1 year) to cadmium.

Numerous studies examining the toxicity of cadmium in workers have identified the respiratory tract and the kidney as sensitive targets of toxicity. A variety of respiratory tract effects have been observed in cadmium workers including respiratory symptoms (e.g., dyspnea, coughing, wheezing), emphysema, and impaired lung function. However, many of these studies did not control for smoking, and thus, the role of cadmium in the induction of these effects is difficult to determine. Impaired lung function was reported in several studies that controlled for smoking (Chan et al. 1988; Cortona et al. 1992; Davison et al. 1988; Smith et al. 1976); other studies have not found significant alterations (Edling et al. 1986). The observed alterations included an increase in residual volume in workers exposed to air concentrations of cadmium fumes ranging from 0.008 (in 1990) to 1.53 mg/m³ (in 1975) (mean urinary cadmium level in the workers was 4.3 µg/L) (Cortona et al. 1992); alterations in several lung function parameters (e.g., forced expiratory volume, transfer factor, transfer coefficient) in workers exposed to 0.034–0.156 mg/m³ (Davison et al. 1988); and decreased force vital capacity in workers exposed to >0.2 mg/m³ (Smith et al. 1976). Additionally, Chan et al. (1988) found significant improvements in several parameters of lung function of workers following reduction or cessation of cadmium exposure.

The renal toxicity of cadmium in workers chronically exposed to high levels of cadmium is well established. Observed effects include tubular proteinuria (increased excretion of low molecular weight proteins), decreased resorption of other solutes (increased excretion of enzymes such as NAG, amino acids, glucose, calcium, inorganic phosphate), evidence of increased glomerular permeability (increased excretion of albumin), increased kidney stone formation, and decreased glomerular filtration rate (GFR). The earliest sign of cadmium-induced kidney damage is an increase in urinary levels of low molecular weight proteins (particularly, β₂-microglobulin, retinol binding protein, and pHC) in cadmium workers, as compared to levels found in a reference group of workers or the general population (Bernard et al. 1990; Chen et al. 2006a, 2006b; Chia et al. 1992; Elinder et al. 1985a; Falck et al. 1983; Jakubowski et al.

2. RELEVANCE TO PUBLIC HEALTH

1987, 1992; Järup and Elinder 1994; Järup et al. 1988; Shaikh et al. 1987; Toffoletto et al. 1992; Verschoor et al. 1987). Although increases in the excretion of low molecular weight proteins are not diagnostic of renal damage (Bernard et al. 1997; Järup et al. 1998b), tubular proteinuria is considered an adverse effect because it is an early change in a sequence of events which ultimately may result in compromised renal function (Bernard et al. 1997). Most investigators consider a 10% cadmium-associated increase in the prevalence of abnormal levels of renal biomarkers (urinary β 2-microglobulin, retinol binding protein, pHC) to be indicative of cadmium-induced renal disease in the population. However, there is less consensus on the low molecular protein level regarded as elevated or abnormal (cut-off point).

Several biomarkers of tubular damage have been used in occupational exposure studies; these include β 2-microglobulin, retinol binding protein, NAG, and pHC. Of these biomarkers, which differ in their sensitivities to detect tubular damage, β 2-microglobulin is the most widely used in occupational exposure studies. In healthy humans, urinary β 2-microglobulin levels are $<300 \mu\text{g}/24 \text{ hours}$ (approximately $300 \mu\text{g}/\text{g creatinine}$). Four studies have estimated the prevalence of abnormal urinary β 2-microglobulin levels among cadmium workers using cut-off levels of $187\text{--}380 \mu\text{g}/\text{g creatinine}$ (Chen et al. 2006a; Elinder et al. 1985a; Jakubowski et al. 1987; Järup and Elinder 1994). The prevalence of abnormal urinary β 2-microglobulin levels was 10% among workers with urinary cadmium levels of $1.5 (\geq 60 \text{ years of age})$ or $5 (<60 \text{ years of age}) \mu\text{g}/\text{g creatinine}$ (β 2-microglobulin cut-off level of $220 \mu\text{g}/\text{g creatinine}$) (Järup and Elinder 1994), 25% among workers with urinary cadmium levels of $2\text{--}5 \mu\text{g}/\text{g creatinine}$ (cut-off level of $300 \mu\text{g}/\text{g creatinine}$) (Elinder et al. 1985a), 40% among workers with urinary cadmium levels of $5\text{--}10 \mu\text{g}/\text{g creatinine}$ (cut-off level of $187 \mu\text{g}/\text{g creatinine}$) (Chen et al. 2006a), and 10% among workers with urinary cadmium levels of $10\text{--}15 \mu\text{g}/\text{g creatinine}$ (cut-off level of $380 \mu\text{g}/\text{g creatinine}$) (Jakubowski et al. 1987). A 10% prevalence of abnormal β 2-microglobulin levels (cut-off level of $300 \mu\text{g}/\text{g creatinine}$) was also observed in workers with a cumulative blood cadmium level of $300 \mu\text{g}\text{-years}/\text{L}$ (30 years of $10 \mu\text{g}/\text{L}$) (Jakubowski et al. 1992) or blood cadmium level of $5.6 \mu\text{g}/\text{L}$ (cumulative exposure of $691 \mu\text{g}\text{-years}/\text{m}^3$) (Järup et al. 1988).

Most of the studies reporting respiratory effects expressed cadmium exposure as air concentrations; however, these air concentrations may not be indicative of cadmium exposure over time. For example, in the Cortona et al. (1992) study, cadmium levels of $0.030 \text{ mg}/\text{m}^3$ were measured in 1990 in one foundry; in 1976, the cadmium levels in this foundry were $1.53 \text{ mg}/\text{m}^3$. Cortona et al. (1992) also reported cadmium body burden data; the mean urinary cadmium level in the workers was $4.3 \mu\text{g}/\text{L}$ (roughly equivalent to $4 \mu\text{g}/\text{g creatinine}$). Renal effects have been observed at similar cadmium burdens. Most studies have

2. RELEVANCE TO PUBLIC HEALTH

reported renal effects in workers with urinary cadmium levels of ≥ 5 $\mu\text{g/g}$ creatinine; Järup and Elinder (1994) found an increased prevalence of low molecular weight proteinuria in workers ≥ 60 years of age with mean urinary cadmium of 1.5 $\mu\text{g/g}$ creatinine. The air concentration that would result in this urinary cadmium level would be considered a LOAEL. However, cadmium in the workplace air was not the only source of cadmium. The workers were also exposed to other sources of cadmium (e.g., cadmium in the diet); both sources contributed to the renal cadmium burden. Thus, in order to calculate a chronic-duration inhalation MRL from the LOAEL identified in the Järup and Elinder (1994) study, the workers' other sources of cadmium need to be taken into consideration; this information was not reported in the study.

An alternative approach would be to use environmental exposure studies to establish a point of departure for the urinary cadmium-renal response relationship and pharmacokinetic models (ICRP 1994; Kjellström and Nordberg 1978) to predict cadmium air concentrations. As described in greater detail in the chronic oral MRL section, a meta-analysis of available environmental exposure studies was conducted to estimate an internal dose (urinary cadmium expressed as $\mu\text{g/g}$ creatinine) corresponding to a 10% excess risk of low molecular weight proteinuria (urinary cadmium dose, UCD_{10}). For the inhalation MRL, the meta-analysis also included dose-response data from three occupational exposure studies (Chen et al. 2006a, 2006b; Järup and Elinder 1994; Roels et al. 1993). Analysis of the environmental exposure studies resulted in an estimation of a urinary cadmium level that would result in a 10% increase in the prevalence of $\beta 2$ -microglobulin proteinuria (1.34 $\mu\text{g/g}$ creatinine); the 95% lower confidence limit on this value was 0.5 $\mu\text{g/g}$ creatinine. The UCD_{10} values from the occupational exposure studies were 7.50 $\mu\text{g/g}$ creatinine for the European cohorts (Järup and Elinder 1994; Roels et al. 1993) and 4.58 $\mu\text{g/g}$ creatinine for the Chinese cohort (Chen et al. 2006a, 2006b). Because the dose-response analysis using the European environmental exposure studies provided the lowest UCD_{10} , it was selected for derivation of the chronic-duration inhalation MRL; the 95% lower confidence limit on this value (UCDL_{10}) of 0.5 $\mu\text{g/g}$ creatinine was used as the point of departure for the MRL.

Deposition and clearance of inhaled cadmium oxide and cadmium sulfide particles were modeled using the ICRP Human Respiratory Tract Model (ICRP 1994). The ICRP model simulates deposition, retention, and absorption of inhaled cadmium particles of specific aerodynamic diameters, when specific parameters for cadmium clearance are used in the model (ICRP 1980). Cadmium-specific parameters represent categories of solubility and dissolution kinetics in the respiratory tract (e.g., slow, S; moderate, M; or fast, F). Cadmium compounds are classified as follows: oxides and hydroxides, S; sulfides, halides and nitrates, M; all other, including chloride salts, F.

2. RELEVANCE TO PUBLIC HEALTH

Inhalation exposures ($\mu\text{g}/\text{m}^3$) to cadmium oxide or cadmium sulfide aerosols having particle diameters of 1, 5, or 10 μg (AMAD) were simulated using the ICRP model. Predicted mass transfers of cadmium from the respiratory tract to the gastrointestinal tract (i.e., mucociliary transport) and to blood (i.e., absorption) were used as inputs to the gastrointestinal and blood compartments of the Nordberg-Kjellström pharmacokinetic model (Kjellström and Nordberg 1978) to simulate the kidney and urinary cadmium levels that correspond to a given inhalation exposure.

As illustrated in [Figure 2-1](#), an airborne cadmium concentration of 1.8–2.4 $\mu\text{g}/\text{m}^3$ as cadmium oxide or 1.2–1.4 $\mu\text{g}/\text{m}^3$ as cadmium sulfide would result in a urinary cadmium level of 0.5 $\mu\text{g}/\text{g}$ creatinine, assuming that there was no dietary source of cadmium. This assumption is not accurate because the diet is a significant contributor to the cadmium body burden. Thus, inhalation exposures were combined with ingestion intakes to estimate an internal dose in terms of urinary cadmium. The age-weighted average intakes of cadmium in non smoking males and females in the United States are 0.35 and 0.30 μg Cd/kg/day, respectively (0.32 $\mu\text{g}/\text{kg}/\text{day}$ for males and females combined) (estimated from data in Choudhury et al. 2001). Based on the relationship predicted between chronic inhalation exposures to cadmium sulfide (activity median aerodynamic diameter [AMAD]=1 μm) and oral intakes that yield the same urinary cadmium level ([Figure 2-1](#)), exposure to an airborne cadmium concentration of 0.1 $\mu\text{g}/\text{m}^3$ and a dietary intake of 0.3 $\mu\text{g}/\text{kg}/\text{day}$ would result in a urinary cadmium level of 0.5 $\mu\text{g}/\text{g}$ creatinine. Dividing this cadmium air concentration (0.1 μg Cd/ m^3) by an uncertainty factor of 3 for human variability and a modifying factor of 3 results in chronic-duration inhalation MRL of 0.01 μg Cd/ m^3 . The uncertainty factor of 3 for human variability was used to account for the possible increased sensitivity of diabetics (Åkesson et al. 2005; Buchet et al. 1990) and the modifying factor of 3 was used to account for the lack of adequate human data, which could be used to compare the relative sensitivities of the respiratory tract and kidneys. Although based on exposure to cadmium sulfide, the MRL would be protective of exposure to cadmium oxide; the pharmacokinetic models predict that exposure to 0.1 $\mu\text{g}/\text{m}^3$ as cadmium oxide (AMAD=1 μm) in combination with a dietary intake of 0.3 $\mu\text{g}/\text{kg}/\text{day}$ would result in a urinary cadmium level of 0.4 $\mu\text{g}/\text{g}$ creatinine.

2. RELEVANCE TO PUBLIC HEALTH

Figure 2-1. Combined Chronic Oral Cadmium Intakes ($\mu\text{g}/\text{kg}/\text{day}$) and Inhalation Cadmium Exposures ($\mu\text{g}/\text{m}^3$) that Achieve a Urinary Cadmium Excretion of $0.5 \mu\text{g}/\text{g}$ Creatinine at Age 55 Years Predicted by the Cadmium Pharmacokinetic Model and the International Commission on Radiological Protection (ICRP) Human Respiratory Tract Model*

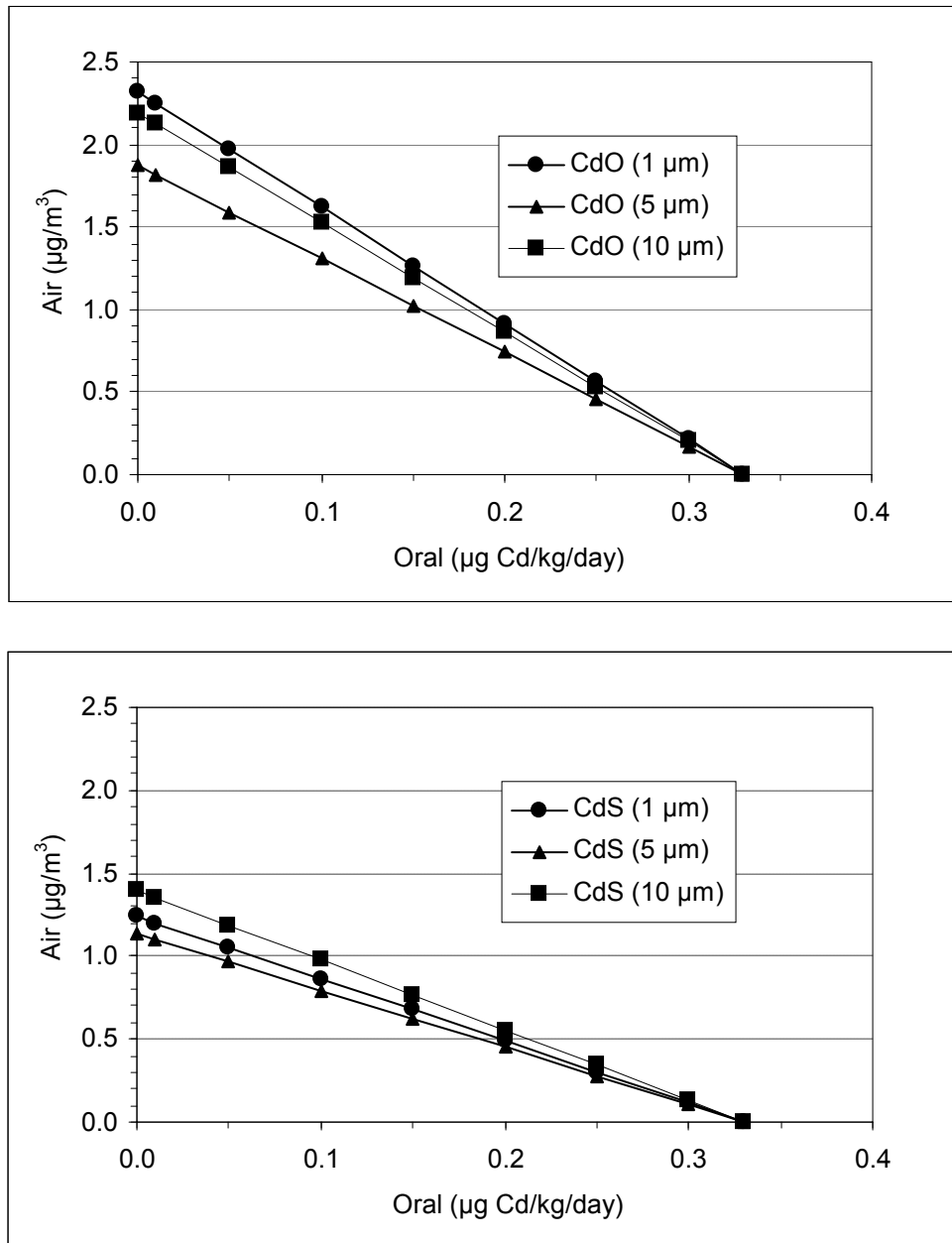

*The upper panel shows simulations of inhalation exposures to cadmium oxide (AMAD=1, 5, or 10 μm); the lower panel shows simulations of inhalation cadmium sulfide aerosols.

2. RELEVANCE TO PUBLIC HEALTH

*Oral MRLs**Acute-Duration Oral MRL*

There are no reliable studies on the acute toxicity of cadmium in humans; animal studies have identified several targets of toxicity. High exposures (>10 mg Cd/kg/day) to cadmium chloride administered via gavage or drinking water resulted in increases in hematological (increased hemoglobin, hematocrit, and erythrocytes, anemia), liver (focal necrosis and degeneration), kidney (focal necrosis of tubular epithelium), intestine (necrosis, hemorrhage, ulcers), stomach (gastritis, necrosis), neurological (decreased motor activity), and testicular (atrophy and necrosis, loss of spermatogenic elements) effects and decreases in body weight in rats and mice (Andersen et al. 1988; Basinger et al. 1988; Bomhard et al. 1987; Borzelleca et al. 1989; Dixon et al. 1976; Kotsonis and Klaassen 1977; Macheimer and Lorke 1981; Sakata et al. 1988; Shimizu and Morita 1990). The NOAELs for these effects ranged from 1.12 to 65.6 mg Cd/kg/day.

Developmental effects have been observed at lower cadmium doses. Delayed ossification of the sternum and ribs was observed in the offspring of rats administered 2 mg Cd/kg/day via gavage on gestation days 7–16; at 40 mg Cd/kg/day, fused lower limbs, decreased number of live fetuses, and increased resorptions were observed (Baranski 1985). A significant increase in malformations was observed in the offspring of rats administered 18.39 mg Cd/kg/day on gestation days 6–15 (Macheimer and Lorke 1981); no developmental effects were observed in the offspring of rats administered 12.5 mg Cd/kg/day via drinking water on gestation days 6–15 (Macheimer and Lorke 1981).

Although the Baranski (1985) study identified the lowest LOAEL (2 mg Cd/kg/day) following acute-duration exposure, this study was not considered suitable for derivation of an MRL. The investigators noted that “a retarded process of ossification of the sternum and ribs was observed after exposure to cadmium at any of the doses used.” However, the data were not shown and the statistical significance of the finding was not reported. Additionally, an intermediate-duration study conducted earlier by this investigator (Baranski et al. 1983) did not find delays in ossification in the offspring of rats administered up to 4 mg Cd/kg/day for 5 weeks prior to mating, during the 3-week mating period, and throughout gestation.

2. RELEVANCE TO PUBLIC HEALTH

Because of the amount of uncertainty associated with the most sensitive end point, an acute-duration oral MRL was not derived.

Intermediate-Duration Oral MRL

- An MRL of 0.5 µg Cd/kg/day has been derived for intermediate-duration oral exposure (15–364 days) to cadmium.

There are limited data on the toxicity of cadmium in humans following intermediate-duration exposure. Numerous animal studies have examined the systemic, immunological, neurological, reproductive, and developmental toxicity of cadmium. The most sensitive systemic effect following intermediate-duration oral exposure to cadmium appears to be damage to growing bone. Exposure to 0.2 mg Cd/kg/day as cadmium chloride in drinking water for 3–12 months resulted in decreases in bone mineral density, impaired mechanical strength of the lumbar spine, tibia, and femur bones, increased bone turnover, and increased incidence of deformed or fractured lumbar spine bone in young female rats (3 weeks of age at study initiation) (Brzóska and Moniuszko-Jakoniuk 2005d; Brzóska et al. 2004b, 2005a, 2005b, 2005c, 2010); similar findings were observed in young male rats exposed to 0.5 mg Cd/kg/day for up to 12 months (Brzóska and Moniuszko-Jakoniuk 2005a, 2005b). Decreases in bone strength were also observed in young rats exposed to 0.8 mg Cd/kg/day as cadmium chloride in drinking water for 4 weeks (Ogoshi et al. 1989); however, no skeletal effects were observed in adult or elderly female rats exposed to doses >20 mg Cd/kg/day for 4 weeks (Ogoshi et al. 1989). Decreases in bone calcium were observed in mice undergoing repeated pregnancy/lactation periods (Bhattacharyya et al. 1988b) or ovariectomized mice (Bhattacharyya et al. 1988c); these changes were not observed in groups not under physiological stress.

Renal effects have been observed at higher doses than the skeletal effects. Vesiculation of the proximal tubules was observed in rats exposed to 1.18 mg Cd/kg/day as cadmium chloride in drinking water for 40 weeks (Gatta et al. 1989). At approximately 3–8 mg Cd/kg/day, proteinuria, tubular necrosis, and decreased renal clearance were observed in rats (Cha 1987; Itokawa et al. 1974; Kawamura et al. 1978; Kotsonis and Klaassen 1978; Prigge 1978a). Liver necrosis and anemia (Cha 1987; Groten et al. 1990; Kawamura et al. 1978) were observed at similar cadmium doses.

Immunological effects have been observed in studies of monkeys, rats, and mice. The observed effects include increases in cell-mediated immune response in monkeys exposed to 5 mg Cd/kg/day as cadmium chloride in the diet for 10 weeks (Chopra et al. 1984), decreased humoral immune response in mice

2. RELEVANCE TO PUBLIC HEALTH

exposed to 2.8 mg Cd/kg/day as cadmium chloride in drinking water for 3 weeks (Blakley 1985), and greater susceptibility to lymphocytic leukemia virus in mice exposed to 1.9 mg Cd/kg/day as cadmium chloride in drinking water for 280 days (Blakley 1986).

Neurological effects observed in rats include decreases in motor activity at 3.1 or 9 mg Cd/kg/day (Kotsonis and Klaassen 1978; Nation et al. 1990) and increased passive avoidance at 5 mg Cd/kg/day (Nation et al. 1984). Reproductive effects (necrosis and atrophy of seminiferous tubules, decreased sperm count and motility) were observed in rats exposed to 8–12 mg Cd/kg/day (Cha 1987; Saxena et al. 1989).

A number of developmental effects have been observed in the offspring of rats exposed to cadmium during gestation and lactation. Decreases in glomerular filtration rates and increases in urinary fractional excretion of phosphate, magnesium, potassium, sodium, and calcium were observed in 60-day-old offspring of rats administered via gavage 0.5 mg Cd/kg/day on gestation days 1–21 (Jacquillet et al. 2007). Neurodevelopmental alterations have also been observed at the low maternal doses. Delays in the development of sensory motor coordination reflexes and increased motor activity were observed at 0.706 mg Cd/kg/day (gestation days 1–21) (Ali et al. 1986), decreased motor activity at 0.04 mg Cd/kg/day (5–8 weeks of pre-gestation exposure, gestation days 1–21) (Baranski et al. 1983), decreased ambulation and rearing activity and altered ECG at 14 mg Cd/kg/day (gestation days 5–15, lactation days 2–28, postnatal days 1–56) (Desi et al. 1998) or 7 mg Cd/kg/day (F_2 and F_3 generations) (Nagymajtenyi et al. 1997) have been observed. Decreases in pup body weight were observed at ≥ 5 mg Cd/kg/day (Baranski 1987; Gupta et al. 1993; Kostial et al. 1993; Pond and Walker 1975) and decreases in fetal body weight or birth weight were observed at ≥ 2.4 mg Cd/kg/day (Petering et al. 1979; Sorell and Graziano 1990; Webster 1978; Sutou et al. 1980). Another commonly reported developmental effect was alterations in hematocrit levels or anemia in the offspring of animals exposed to ≥ 1.5 mg Cd/kg/day (Baranski 1987; Kelman et al. 1978; Webster 1978). Increases in the occurrence of malformations or anomalies is limited to a study by Sutou et al. (1980), which reported a significant delay in ossification in rats exposed to 10 mg Cd/kg/day.

The animal studies identify several sensitive targets of toxicity following intermediate-duration exposure to cadmium; these include skeletal mineralization in young female rats exposed for at least 3 months to 0.2 mg Cd/kg/day (Brzóska and Moniuszko-Jakoniuk 2005d; Brzóska et al. 2004b, 2005a, 2005b, 2005c), decreased glomerular filtration in young rats exposed during gestation to maternal doses of 0.5 mg Cd/kg/day (Jacquillet et al. 2007), and neurodevelopmental effects following gestational exposure to 0.04 mg Cd/kg/day (Baranski et al. 1983). Although the Baranski et al. (1983) study reported the lowest

2. RELEVANCE TO PUBLIC HEALTH

LOAEL, it was not selected as the principal study for derivation of an intermediate-duration MRL. For locomotor activity, a significant decrease in activity was observed in female offspring exposed to 0.04, 0.4, and 4 mg Cd/kg/day, as compared to controls; however, no significant differences were found between the cadmium groups despite the 100-fold difference in doses. Locomotor activity was also decreased in males exposed to 0.4 or 4 mg Cd/kg/day. For the rotorod test, a significant decrease in the length of time the rat stayed on the rotorod was observed in males exposed to 0.04 and 0.4 mg Cd/kg/day, but not to 4 mg Cd/kg/day and in females exposed to 0.4 and 4 mg Cd/kg/day; no differences between the cadmium groups were observed in the males and females. The results were not well described and the investigators did not explain the lack of dose-response of the effects or the discrepancy between genders.

The skeletal effects observed in young rats exposed to cadmium during the period of rapid skeletal growth and mineralization was selected as the critical effect. The Brzóska and associate study (Brzóska and Moniuszko-Jakoniuk 2005d; Brzóska et al. 2005a, 2005c) was selected as the principal study. In this study, groups of 40 3-week-old female Wistar rats were exposed to 0, 1, 5, or 50 mg Cd/L as cadmium chloride in drinking water for 12 months. The investigators noted that cadmium intakes were 0.059–0.219, 0.236–1.005, and 2.247–9.649 mg Cd/kg/day in the 1, 5, and 50 mg/L groups, respectively. Using cadmium intake data presented in a figure, cadmium intakes of 0.2, 0.5, and 4 mg Cd/kg/day were estimated. Bone mineral density, bone mineral concentration, and mineralization area of the lumbar spine, femur, and total skeleton (bone mineral density only) were assessed after 3, 6, 9, or 12 months of exposure. The mechanical properties of the femur and tibia were evaluated after 12 months of exposure. Markers for bone resorption (urinary and serum levels of C-terminal cross-linking telopeptide of type I collagen [CTX]) and bone formation (serum osteocalcin, total alkaline phosphatase, and cortical bone and trabecular bone alkaline phosphatase), and serum and urinary levels of calcium were also measured at 3, 6, 9, and 12 months.

No significant alterations in body weight gain or food and water consumption were observed. Significant decreases in total skeletal bone mineral density was observed at ≥ 0.2 mg Cd/kg/day; the decrease was significant after 3 months in the 4 mg Cd/kg/day group, after 6 months in the 0.5 mg Cd/kg/day group, and after 9 months in the 0.2 mg Cd/kg/day group. Significant decreases in whole tibia and diaphysis bone mineral density were observed at ≥ 0.2 mg Cd/kg/day after 12 months of exposure. At 0.2 mg Cd/kg/day, bone mineral density was decreased at the proximal and distal ends of the femur after 6 months of exposure; diaphysis bone mineral density was not affected. At 0.5 mg Cd/kg/day, bone mineral density was decreased at the femur proximal and distal ends after 3 months of exposure and diaphysis bone mineral density after 6 months of exposure. At 4 mg Cd/kg/day decreases in femoral

2. RELEVANCE TO PUBLIC HEALTH

proximal, distal, and diaphysis bone mineral density were decreased after 3 months of exposure. Similarly, bone mineral density was significantly decreased in the lumbar spine in the 0.2 and 0.5 mg Cd/kg/day groups beginning at 6 months and at 3 months in the 4 mg Cd/kg/day group. Significant decreases in the mineralization area were observed in the femur and lumbar spine of rats exposed to 4 mg Cd/kg/day; lumbar spine bone mineral area was also affected at 0.5 mg Cd/kg/day. Significant decreases in tibia weight and length were observed at 4 mg Cd/kg/day. In tests of the mechanical properties of the tibia diaphysis, significant alterations in ultimate load, yield load, and displacement at load were observed at ≥ 0.2 mg Cd/kg/day; work to fracture was also significantly altered at 4 mg Cd/kg/day. In the mechanical properties compression tests of the tibia, significant alterations were observed in ultimate load, ultimate load, and stiffness at 0.2 mg Cd/kg/day; displacement at yield and work to fracture at ≥ 0.5 mg Cd/kg/day; and displacement at ultimate at 4 mg Cd/kg/day. Multiple regression analysis showed that the cadmium-induced weakness in bone mechanical properties of the tibia was primarily due to its effects on bone composition, particularly the non-organic components, organic components, and the ratio of ash weight to organic weight. The mechanical properties of the femur were strongly influenced by the bone mineral density (at the whole bone and diaphysis). A significant decrease in femur length was observed at 6 months of exposure to ≥ 0.2 mg Cd/kg/day; however, decreases in length were not observed at other time points in the 0.2 or 0.5 mg Cd/kg/day groups. Femur weight was significantly decreased at 4 mg Cd/kg/day. In tests of mechanical properties of the femur (neck and distal portions), decreases in yield load, ultimate load, displacement at ultimate, work to fracture (neck only), and stiffness (distal only) were observed at ≥ 0.2 mg Cd/kg/day. For the femoral diaphysis, significant alterations were observed for yield load, displacement at yield, and stiffness at ≥ 0.2 mg Cd/kg/day. Significant decreases in osteocalcin concentrations were observed in all cadmium groups during the first 6 months of exposure, but not during the last 6 months. Decreases in total alkaline phosphatase levels at 4 mg Cd/kg/day, trabecular bone alkaline phosphatase at 0.2 mg Cd/kg/day, and cortical bone alkaline phosphatase at 4 mg Cd/kg/day were observed. CTX was decreased at ≥ 0.2 mg Cd/kg/day. Total urinary calcium and fractional excretion of calcium were increased at ≥ 0.2 mg Cd/kg/day.

At the lowest dose tested, 0.2 mg Cd/kg/day, a number of skeletal alterations were observed including decreases in bone mineral density in the lumbar spine, femur, and tibia, alterations in the mechanical properties of the femur and tibia, decreases in osteocalcin levels, decreases in trabecular bone alkaline phosphatase, and decreases in CTX. Of these skeletal end points, the decrease in bone mineral density was selected as the critical effect because Brzóska et al. (2005a, 2005c) demonstrated that the bone mineral density was a stronger predictor of femur and tibia strength and the risk of fractures. As discussed in greater detail in Appendix A, available continuous models in the EPA Benchmark Dose

2. RELEVANCE TO PUBLIC HEALTH

Software (version 1.4.1c) were fit to data for changes in bone mineral density of the femur and lumbar spine in female rats resulting from exposure to cadmium in the drinking water for 6, 9, or 12 months (Brzóska and Moniuszko-Jakoniuk 2005d). The benchmark dose (BMD) and the 95% lower confidence limit (BMDL) is an estimate of the doses associated with a change of 1 standard deviation from the control. The BMDL_{sd1} derived from the best fitting models for each dataset ranged from 0.05 to 0.17 mg Cd/kg/day. The BMDL_{sd1} of 0.05 mg Cd/kg/day estimated from the 9-month lumbar spine data set was selected as the point of departure for the MRL. In young female rats, the process of intense bone formation occurs during the first 7 months of life (the first 6 months of exposure in this study); thereafter, the increase in bone mineral density slows. In the lumbar spine of the control group, the changes in bone mineral density at 3–6 months, 6–9 months, and 9–12 months were 15, 4, and 1%, respectively. Thus, the 9-month data may best reflect the effect of cadmium on bone mineral density during the period of rapid skeletal growth. The lumbar spine data was selected over the femur data set because trabecular bone, which is abundant in the spine, appears to be more susceptible to cadmium toxicity than cortical bone. The BMDL_{sd1} was divided by an uncertainty factor of 100 (10 for extrapolation from animals to humans and 10 for human variability) resulting in an intermediate-duration oral MRL of 0.5 µg Cd/kg/day.

Chronic-Duration Oral MRL

- [An MRL of 0.1 µg/kg/day has been derived for chronic-duration oral exposure \(≥1 year\) to cadmium.](#)

The database examining the chronic toxicity of cadmium following oral exposure is extensive. Although there are some chronic studies in animals, the majority of the studies in the chronic database examine the relationship between urinary cadmium levels (or cumulative cadmium intake) and adverse health effects in the general population or in populations living in cadmium polluted areas. A variety of health effects have been observed including skeletal defects (osteoporosis, increased bone fractures, decreased bone mineral density), kidney dysfunction, and alterations in reproductive hormone levels. These environmental exposure studies strongly support the identification of bone and kidney as the most sensitive targets of chronic cadmium toxicity.

Bone effects, particularly osteomalacia and/or osteoporosis and increased bone fractures, were first reported in Japanese women living in areas with heavy cadmium contamination. Chronic cadmium exposure has been shown to play a role in this disorder, referred to as Itai-Itai disease; however, other factors such as multiple pregnancies, poor nutrition (low calories, calcium, protein, vitamin D, and iron intakes), and low zinc levels in food also play important roles in the etiology. Although a conclusive role

2. RELEVANCE TO PUBLIC HEALTH

of cadmium in Itai-Itai has not been established, several other studies have found bone defects. Observed bone effects include increased risk of bone fractures in postmenopausal women with urinary cadmium levels of $>1 \mu\text{g/day}$ (approximately $>0.7 \mu\text{g Cd/g creatinine}$; Staessen et al. 1999), individuals (>50 years of age) with urinary cadmium levels of $>2 \mu\text{g/g creatinine}$ (Alfvén et al. 2004), and men and women (>40 years of age) with urinary cadmium levels of 9.20 and 12.86 $\mu\text{g/g creatinine}$, respectively (Wang et al. 2003); increased risk of osteoporosis in men (>60 years of age) with urinary cadmium levels of $\geq 1.5 \mu\text{g/g creatinine}$ (Alfvén et al. 2000), in males and females with urinary cadmium levels of $\geq 10 \mu\text{g/g creatinine}$ (Jin et al. 2004b), in males and females (>40 years of age) with urinary cadmium levels of 9.20 and 12.86 $\mu\text{g/g creatinine}$, respectively (Wang et al. 2003), and women with renal tubular damage (urinary NAG $\geq 12 \text{ IU/g creatinine}$) (Chen et al. 2011); and decreased bone mineral density in women with urinary cadmium levels of $>0.6 \mu\text{g/g creatinine}$ (Schutte et al. 2008), postmenopausal women with urinary cadmium levels of $>20 \mu\text{g/g creatinine}$ (Nordberg et al. 2002), postmenopausal women with median urinary cadmium levels of 1.1 $\mu\text{g/g creatinine}$ (Engström et al. 2009), and men with urinary cadmium levels of $\geq 2 \mu\text{g/g creatinine}$ (Trzcinka-Ochocka et al. 2010).

Evidence of renal dysfunction in environmentally exposed populations include increases in deaths from renal dysfunction in residents living in cadmium polluted areas of Japan (Arisawa et al. 2001, 2007b; Iwata et al. 1991a, 1991b; Matsuda et al. 2002; Nakagawa et al. 1993; Nishijo et al. 1995, 2004a, 2006), increases in renal replacement therapy which is indicative of severe renal dysfunction (Hellström et al. 2001), and increases in the excretion of biomarkers of renal dysfunction in association with increased cadmium intake, increased renal cadmium concentrations, increased blood cadmium levels, and/or increased urinary cadmium concentrations (Bandara et al. 2010; Buchet et al. 1990; Cai et al. 1990, 1992, 1998, 2001; Ferraro et al. 2010; Hayano et al. 1996; Honda et al. 2010; Horiguchi et al. 2004, 2010; Hwangbo et al. 2011; Ishizaki et al. 1989; Izuno et al. 2000; Järup et al. 2000; Jin et al. 2002, 2004a, 2004c; Kawada et al. 1992; Kido and Nogawa 1993; Kobayashi et al. 2002a, 2009b; Monzawa et al. 1998; Nakadaira and Nishi 2003; Nakashima et al. 1997; Nogawa et al. 1989; Noonan et al. 2002; Nordberg et al. 1997; Olsson et al. 2002; Oo et al. 2000; Osawa et al. 2001; Roels et al. 1981b; Suwazono et al. 2006; Teeyakasem et al. 2007; Trzcinka-Ochocka et al. 2004; Uno et al. 2005; Yamanaka et al. 1998; Wu et al. 2001). The urinary excretion of several biomarkers have been shown to increase due to cadmium-related alterations in kidney function; these biomarkers include low molecular weight proteins (e.g., β_2 -microglobulin, pHC, retinol binding protein), intracellular tubular enzymes (e.g., NAG), amino acids, high molecular weight proteins (e.g., albumin), metallothionein, and electrolytes (e.g., potassium, sodium, calcium). Although the more severe renal effects have been observed in populations living in highly contaminated areas (e.g., decreased glomerular filtration rate), alterations in the above biomarkers

2. RELEVANCE TO PUBLIC HEALTH

have been observed in areas not considered to be cadmium polluted. Alterations in these biomarker levels appear to be the most sensitive indicator of cadmium toxicity. Many of the studies examining biomarkers have reported significant correlations between urinary cadmium levels and biomarker levels. However, these correlations do not provide insight into exposure levels associated with renal dysfunction. In this MRL analysis, attention was given to dose-response studies examining the derived quantitative relationships between cadmium exposure and the prevalence of abnormal biomarker levels. As discussed in the inhalation MRL section, a 10% increase in the prevalence of abnormal biomarker levels (particularly β 2-microglobulin, pHC, or retinol binding protein) in association with increasing cadmium exposure is generally considered to be indicative of cadmium-associated renal dysfunction in populations. However, when examining the prevalence of abnormal levels, careful consideration should be given to the response criterion (cut-off level) used in the study. A wide range of cut-off levels have been used in the environmental exposure studies. For β 2-microglobulin, the most commonly used biomarker, the cut-off values ranged from 283 to 1,129 μ g/g creatinine. A summary of environmental studies finding significant dose-response associations between urinary cadmium (or cumulative cadmium intake) and the prevalence of abnormal levels of urinary biomarkers of renal dysfunction is presented in [Table 2-1](#). The adverse effect levels range from urinary cadmium levels of 1 μ g/g creatinine (Järup et al. 2000) to 9.51 μ g/g creatinine (Jin et al. 2004a).

The adverse effect levels for renal effects were similar to those observed for skeletal effects. Because the renal effects database is stronger, it was used for derivation of a chronic-duration oral MRL for cadmium. Several approaches were considered for derivation of the MRL: (1) NOAEL/LOAEL approach using a single environmental exposure study finding an increased prevalence of abnormal renal effect biomarker levels, (2) selection of a point of departure from a published benchmark dose analysis, or (3) selection of a point of departure based on an analysis of the dose-response functions from a number of environmental exposure studies.

In the first approach, all studies in which individual internal doses for subjects were estimated based on urinary cadmium were considered. The Järup et al. (2000) study is selected as the principal study because it identified the lowest adverse effect level ([Table 2-1](#)). In this study, 1,021 individuals living near a nickel-cadmium battery factory (n=799) or employed at the factory (n=222) were examined. The mean urinary cadmium concentrations were 0.81 μ g/g creatinine in men and 0.65 μ g/g creatinine in women. A significant association was found between urinary cadmium concentrations and urinary pHC levels, after adjustment for age; the association remained statistically significant after removal of the cadmium workers from the analysis. The investigators estimated that a urinary cadmium level of 1 μ g/g creatinine

2. RELEVANCE TO PUBLIC HEALTH

Table 2-1. Summary of Human Studies Finding Dose-Response Relationships Between Biomarkers of Renal Dysfunction and Cadmium Exposure

Population	Effect biomarker	Response criterion	Adverse effect level (urinary cadmium)	Reference
General population (Japan)	Total prt	157.4 µg/g creat. (M) 158.5 µg/g creat. (F)	2.4 µg/g creat. ^a	Suwazono et al. 2006
	β2M	507 µg/g creat. (M) 400 µg/g creat. (F)		
	NAG	8.2 µg/g creat. (M) 8.5 µg/g creat. (F)		
General population (Belgium)	β2M	283 µg/24 hours	1.92 µg/g creat. ^b	Buchet et al. 1990
	RBP	338 µg/24 hours		
	NAG	3-6 IU/24 hours		
	amino acid calcium	357 mg α-N/24 hours 4-9 mmol/24 hours		
Residents in cadmium-polluted area (China)	β2M	355 µg/g creat. (M <45 years) >2,500 µg/g creat. (M ≥45 years) 500 µg/g creat. (F)	4–7.99 µg/g creat. ^c	Cai et al. 1998
		Residents in cadmium-polluted area (China)		
Residents in cadmium-polluted area (China)	β2M NAG albumin	800 µg/g creat.	9.51 µg/g creat.	Jin et al. 2004a
		15 U/g creat.		
		20 mg/g creat.		
Residents in cadmium-polluted area (China)	β2M	800 µg/g creat.	2–4 µg/g creat. ^c	Nordberg et al. 1997
Residents in cadmium-polluted area (Japan)	β2M	1,000 µg/g creat.	6.9 µg/g creat.	Cai et al. 2001
Residents in cadmium-polluted area (Japan)	β2M	1,000 µg/g creat. (M,F)	Cadmium intake: 150 µg/day	Nogawa et al. 1989; Kido and Nogawa 1993
Residents in cadmium-polluted area (Japan)	β2M	1,129 µg/g creat. (M) 1,059 µg/g creat. (F)	4–4.9 µg/g creat. ^c	Ishizaki et al. 1989; Hayano et al. 1996

2. RELEVANCE TO PUBLIC HEALTH

Table 2-1. Summary of Human Studies Finding Dose-Response Relationships Between Biomarkers of Renal Dysfunction and Cadmium Exposure

Population	Effect biomarker	Response criterion	Adverse effect level (urinary cadmium)	Reference
Residents in cadmium-polluted area (Thailand)	β2M	400 µg/g creat.	6–10 µg/g creat.	Teeyakasem et al. 2007
Residents in cadmium-polluted area (includes occupationally exposed subjects (Sweden))	pHC	7.1 mg/g creat. (M) 5.3 mg/g creat. (F)	1 µg/g creat. ^d	Järup et al. 2000

^aMean urinary cadmium level

^b>10% prevalence of abnormal β2-microglobulin, retinal binding protein, amino acid, and calcium values at 3.05, 2.87, 2.74, 4.29, or 1.92 µg/24 hours, respectively.

^cUrinary cadmium level associated with an approximate doubling of prevalence of abnormal β2-microglobulin levels

^dThe European Chemicals Bureau (2007) recalculated this value (using raw data from Järup et al. 2000) to account for differences in age of the reference population and study population; based on these recalculations, a doubling of the probability of abnormal pHC values would occur at 2.62 µg/g creatinine for the total population and a 0.5 µg/g creatinine for the environmentally exposed population.

AAP = alanine aminopeptidase; β2M = β2-microglobulin; creat. = creatinine; F = female; M = male; NAG = N-acetyl-β-glucosaminidase; pHC = human complex-forming glycoprotein, also referred to as α1M; RBP = retinol binding protein

2. RELEVANCE TO PUBLIC HEALTH

would be associated with a 10% increase in the prevalence of abnormal pHc levels above background prevalence (approximately a 10% added risk). However, the European Chemicals Bureau (2007) recalculated the probability of HC proteinuria because the reference population and the study population were not matched for age (40 versus 53 years, respectively). They estimated that the probability of HC proteinuria (13%) would be twice as high as the reference population at a urinary cadmium concentration of 0.5 µg/g creatinine.

The second approach involves the evaluation of eight published benchmark dose analyses. The benchmark doses and the lower 95% confidence interval of the benchmark dose (BMDL) for low molecular weight proteinuria are presented in [Table 2-2](#) (benchmark doses and BMDLs for all effect parameters are presented in [Table 3-8](#) in the toxicological profile). The BMDL values corresponding to a 10% increase in the prevalence of low molecular weight proteinuria above background (excess risk) ranged from 0.7 µg/g creatinine (Uno et al. 2005) to 9.9 µg/g creatinine (Kobayashi et al. 2006). Both studies examined populations living in non-cadmium polluted areas of Japan and used β₂-microglobulin as the effect biomarker. The large difference in cut-off values (233 versus 784 µg/g creatinine) likely contributed to the order of magnitude difference in BMDLs. The BMDL₁₀ of 0.7 µg/g creatinine is supported by the Suwazono et al. (2006) benchmark dose analysis, which found a similar BMDL₁₀ (0.81 µg/g creatinine) using pHc as the effect biomarker. The Uno et al. (2005) study examined 410 men and 418 women (aged 40–59 years) living in three areas of Japan without any known environmental cadmium pollution. Mean urinary cadmium concentrations were 1.3 and 1.6 µg/g creatinine in men and women, respectively. Cut-off levels for β₂-microglobulin were 233 and 274 µg/g creatinine in males and females; these values represent the 84% upper limit values calculated from the target population assuming a log normal distribution.

The third approach involved a meta-analysis of selected environmental exposure dose-response studies. Studies were selected for inclusion in this analysis based on the following qualitative criteria: (1) the study measured urinary cadmium as indicator of internal dose; (2) the study measured reliable indicators of low molecular weight (LMW) proteinuria; (3) a dose-response relationship was reported in sufficient detail so that the dose-response function could be reproduced independently; (4) the study was of reasonable size to have provided statistical strength to the estimates of dose-response model parameters (i.e., most studies selected included several hundred to several thousand subjects); and (5) major co-variables that might affect the dose-response relationship (e.g., age, gender) were measured or constrained by design and included in the dose-response analysis. No attempt was made to weight selected studies for quality, statistical power, or statistical uncertainty in dose-response parameters. Studies using a cut-off

2. RELEVANCE TO PUBLIC HEALTH

Table 2-2. Selected Benchmark Dose Estimations of Urinary Cadmium Levels Associated with Increases in the Prevalence of Low Molecular Weight Proteinuria

Study population	Effect biomarker	Response criterion	BMD model	5% BMR		10% BMR		Reference
				BMD	BMDL	BMD	BMDL	
General population (Sweden)	pHC	6.8 mg/g creat. (95% cut-off) ^a	Profile likelihood method	0.63 (F)	0.49 (F)	1.05 (F)	0.81 (F)	Suwazono et al. 2006
Residents in cadmium-polluted and non-polluted areas (Japan)	β2M	507 µg/g creat. (M)	Quantal linear model	1.5 (M)	1.2 (M)	3.1 (M)	2.5 (M)	Shimizu et al. 2006
		400 µg/g creat. (F)		1.4 (F)	1.1 (F)	2.9 (F)	2.3 (F)	
		994 µg/g creat. (M) 784 µg/g creat. (F) (95% cut-off) ^c		2.3 (M) 1.7 (F)	1.8 (M) 1.4 (F)	4.7 (M) 3.5 (F)	3.7 (M) 2.9 (F)	
Residents in cadmium-polluted ^d and nonpolluted areas (Japan)	β2M	915.5 µg/g creat. (M) 897.1 µg/g creat. (F) (95% cut-off) ^e	Profile likelihood method	4.0 (M) 4.0 (F)	3.5 (M) (3.7) (F)	Not calculated		Suwazono et al. 2011b
General population (Japan)	β2M	507 µg/g creat. (M)	Log-logistic model	2.9 (M)	2.4 (M)	5.0 (M)	4.0 (M)	Kobayashi et al. 2006
		400 µg/g creat. (F)		3.8 (F)	3.3 (F)	6.6 (F)	5.5 (F)	
		994 µg/g creat. (M) 784 µg/g creat. (F) (95% cut-off) ^g		6.4 (M) 8.7 (F)	4.5 (M) 7.3 (F)	10.2 (M) 12.0 (F)	7.1 (M) 9.9 (F)	
General population (Japan)	β2M	492 µg/g creat. (M)	Multiple logistic model	3.0 (M)	2.7 (M)	5.0 (M)	4.6 (M)	Kobayashi et al. 2008a
		407 µg/g creat. (F)		3.4 (F)	3.2 (F)	5.7 (F)	5.4 (F)	
		965 µg/g creat. (M) 798 µg/g creat. (F) (97.5% cut-off) ⁱ		4.9 (M) 5.9 (F)	4.5 (M) 5.6 (F)	7.4 (M) 8.6 (F)	6.8 (M) 8.1 (F)	
General population (Japan)	β2M	708 µg/g creat. (M) 415 µg/g creat. (F) (95% cut-off) ^j	Profile likelihood method	3.4 (M) 1.7 (F)	2.6 (M) 1.4 (F)	Not calculated		Suwazono et al. 2011c

2. RELEVANCE TO PUBLIC HEALTH

Table 2-2. Selected Benchmark Dose Estimations of Urinary Cadmium Levels Associated with Increases in the Prevalence of Low Molecular Weight Proteinuria

Study population	Effect biomarker	Response criterion	BMD model	5% BMR		10% BMR		Reference
				BMD	BMDL	BMD	BMDL	
General population (Japan)	β2M	233 µg/g creat. (M) 274 µg/g creat. (F) (84% cut-off) ^k	Quantal linear model	0.5 (M) 0.9 (F)	0.4 (M) 0.8 (F)	1.0 (M) 1.8 (F)	0.7 (M) 1.3 (F)	Uno et al. 2005
Residents in cadmium highly, or moderately polluted area (China)	β2M	800 µg/g creat. (95% cut-off) ^l	Quantal linear	5.86 (M) 9.98 (F)	4.74 (M) 8.47 (F)			Jin et al. 2004c
	RBP	0.300 mg/g creat. (95% cut-off) ^l	logistic regression model	5.99 (M) 9.03 (F)	4.87 (M) 7.63 (F)			

^a95th percentile of effect biomarkers on the “hypothetical” control distribution at a urinary cadmium level of zero.

^b84% upper limit values from a group of 424 males and 1,611 females who did not smoke and lived in three different cadmium nonpolluted areas.

^c95% upper limit values from a group of 424 males and 1,611 females who did not smoke and lived in three different cadmium nonpolluted areas.

^dSame population of residents living in polluted area as Shimizu et al. (2006).

^e95th percentile calculated by benchmark model at no cadmium exposure (urinary cadmium equal to zero), adjusted to mean age.

^f84% upper limit value of the target population of people who have not smoked.

^g95% upper limit value of the target population of people who have not smoked.

^h84th percentile level in subjects from nonpolluted areas.

ⁱ97.5th percentile level in subjects from nonpolluted areas.

^j95th percentile calculated by benchmark model at no cadmium exposure (urinary cadmium equal to zero), adjusted to mean age.

^k84% upper limit value of the target population.

^l95% upper limit value from a control group 98 males and 155 females living in a cadmium nonpolluted area.

BMD = benchmark dose; BMDL = benchmark dose low; BMR = benchmark response; β2M = β2-microglobulin; creat. = creatinine; F = female; M = male; NAG = *N*-acetyl-β-D-glucosaminidase; NAG-B = *N*-acetyl-β-D-glucosaminidase's isoform B; RBP = retinol binding protein

2. RELEVANCE TO PUBLIC HEALTH

value for β 2-microglobulin of $\geq 1,000$ $\mu\text{g/g}$ creatinine were eliminated from the analysis based on the conclusions of Bernard et al. (1997) that urinary β 2-microglobulin levels of 1,000–10,000 $\mu\text{g/g}$ creatinine were indicative of irreversible tubular proteinuria, which may lead to an age-related decline in GFR. Additionally, an attempt was made to avoid using multiple analyses of the same study population.

The individual dose-response functions from each study were implemented to arrive at estimates of the internal dose (urinary cadmium expressed as $\mu\text{g/g}$ creatinine) corresponding to probabilities of 10% excess risk of low molecular weight proteinuria (urinary cadmium dose, UCD_{10}). Estimates were derived from the seven environmental exposure studies listed in Table 2-3. When available, male and female data were treated separately; thus, 11 dose-response relationships were analyzed. For studies that did not report the UCD_{10} , the value was estimated by iteration of the reported dose response relationship for varying values of urinary cadmium, until an excess risk of 10% was achieved:

$$ER = \frac{P(d) - P(0)}{1 - P(0)}$$

where ER is the excess risk, $P(d)$ is the probability of low molecular weight proteinuria associated with a given internal (i.e., urinary cadmium) dose, and $P(0)$ is the background probability (i.e., the probability predicted by the dose-response model when urinary cadmium was zero). For studies that reported the dose-response relationship graphically, but did not report the actual dose-response function, a function was derived by least squares fitting based on data from a digitization of the graphic.

Aggregate UCD_{10} estimates and the estimates stratified by location (i.e., Europe, Japan, China) are presented in Figure 2-2. The lowest UCD_{10} (1.34 $\mu\text{g/g}$ creatinine) was estimated from the European database and the 95% lower confidence limit on this UCD_{10} (UCDL_{10}) of 0.5 $\mu\text{g/g}$ creatinine was considered as a potential point of departure for the MRL.

Points of departure selected using the three different approaches are similar: 0.5 $\mu\text{g/g}$ creatinine from the Järup et al. (2000) study (using the European Chemicals Bureau 2007 recalculation), 0.7 $\mu\text{g/g}$ creatinine from the Uno et al. (2005) benchmark dose analysis, and 0.5 $\mu\text{g/g}$ creatinine from the dose-response analysis. The third approach (meta-analysis of environmental exposure studies) was selected for the derivation of the MRL because it uses the whole dose-response curves from several studies rather than data from a single study.

2. RELEVANCE TO PUBLIC HEALTH

Table 2-3. Selected Studies of Dose-Response Relationship for Cadmium-Induced Low Molecular Weight Proteinuria

Reference	Population	Number	Effect biomarker	Response criterion	Dose-response model	UCD ₁₀ (µg/g creat.)
Buchet et al. 1990	General population (Belgium)	1,699 M 2,080 F	β2M	283 µg/24 hours	Logistic ^a	2.51 M 1.44 F
Suwazono et al. 2006	General population (Sweden)	790 F	pHC	3.6 U/g creat.	Logistic	0.81
Järup et al. 2000	Residents in cadmium polluted area (Sweden)	1,465 M,F	pHC	7.1 mg/g creat. M 5.3 mg/g creat. F	Logistic	0.6
Kobayashi et al. 2006	General population (Japan)	1,114 M 1,664 F	β2M	507 µg/g creat. M 400 µg/g creat. F	Log-logistic	5.0 M 6.6 F
Shimizu et al. 2006	Residents in cadmium polluted and non-polluted areas (Japan)	1,865 M 1,527 F	β2M	507 µg/g creat. M 400 µg/g creat. F	Log-logistic	5.1 M 4.2 F
Jin et al. 2004c	Residents in cadmium polluted or non-polluted area (China)	790 M,F	β2M	800 µg/g creat.	Logistic	9.5 M 15.4 F
Wu et al. 2001	Residents in cadmium polluted area (China)	247 M,F	β2M	800 µg/g creat. M 900 µg/g creat. F	Linear ^b	3.75

^aDigitized from Figure 2 in Lauwerys et al. 1991

^bDigitized from Figure 2 in Wu et al. 2001

β2M = β2-microglobulin; creat. = creatinine; F = female; M = male; pHC = human complex-forming glycoprotein (also referred to as α1-microglobulin); UCD₁₀ = urinary cadmium level corresponding to a probability of 10% excess risk of low molecular weight proteinuria

2. RELEVANCE TO PUBLIC HEALTH

Figure 2-2. Estimates of the UCD₁₀ from Environmental Exposure Dose-Response Studies*

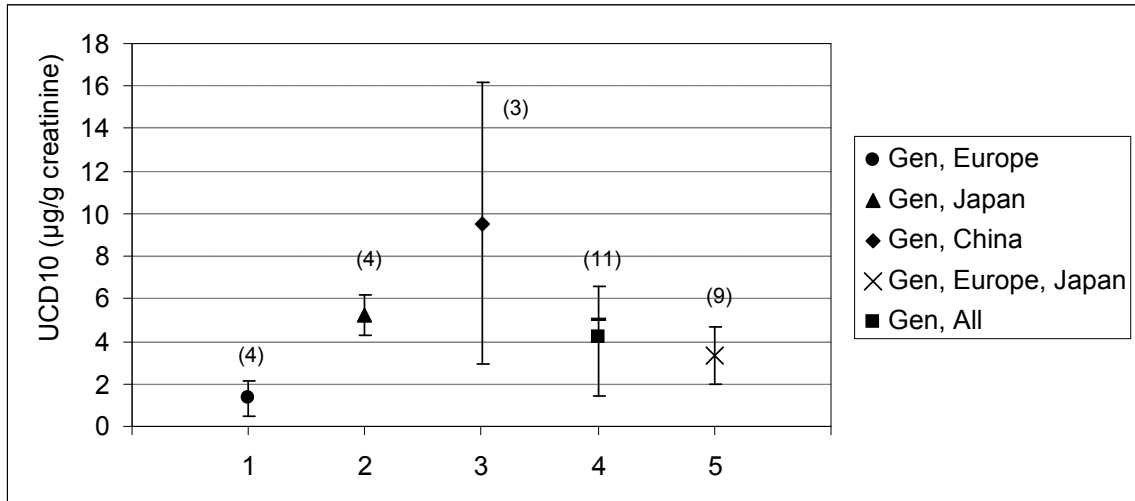

*Estimates of urinary cadmium concentrations (µg/g creatinine) associated with a 10% excess risk of urinary β₂-microglobulin (UCD₁₀) using data from European, Japanese, and Chinese studies. For the aggregate of studies (plot #4), the mean (-), median (•), and 95% confidence intervals (CI) on the median are shown. All other plots show the mean and 95% CI on the mean. Numbers in parenthesis are the number of estimates of the UCD₁₀.

2. RELEVANCE TO PUBLIC HEALTH

The UC_{DL10} of 0.5 µg/g creatinine was transformed into estimates of chronic cadmium intake (expressed as µg Cd/kg/day) that would result in the UC_{DL10} at age 55 (approximate age of peak cadmium concentration in the renal cortex associated with a constant chronic intake; Figure 2-3). The dose transformations were achieved by simulation using a modification of the Nordberg-Kjellström model (Kjellström and Nordberg 1978). The following modifications (Choudhury et al. 2001; Diamond et al. 2003) were made to the model: (1) the equations describing intercompartmental transfers of cadmium were implemented as differential equations in Advanced Computer Simulation Language (acslXtreme, version 2.4.0.9); (2) growth algorithms for males and females and corresponding organ weights (O’Flaherty 1993) were used to calculate age-specific cadmium concentrations from tissue cadmium masses; (3) the cadmium concentration in renal cortex (RC, µg/g) was calculated as follows:

$$RC = 1.5 \cdot \frac{K}{KW}$$

where K is the age-specific renal cadmium burden (µg) and KW is the age-specific kidney wet weight (g) (Friberg et al. 1974).

(4) the rate of creatinine excretion (e.g., Cr_{ur}, g creatinine/day) was calculated from the relationship between lean body mass (LBM) and Cr_{ur}; and (5) absorption of ingested cadmium was assumed to be 5% in males and 10% in females. The rate of creatinine excretion (e.g., Cr_{ur}, g creatinine/day) was estimated from the relationship between LBM (kg) and Cr_{ur}:

$$LBM = 27.2 \cdot Cr_{ur} + 8.58$$

where the constants 27.2 and 8.58 are the sample size-weighted arithmetic mean of estimates of these variables from eight studies reported in (Forbes and Bruining 1976). Lean body mass was estimated as follows (ICRP 1981):

$$LBM = BW \cdot 0.85, \text{adult females}$$

$$LBM = BW \cdot 0.88, \text{adult males}$$

where the central tendency for adult body weight for males and females were assumed to be 70 and 58 kg for adult European/American males and females, respectively.

2. RELEVANCE TO PUBLIC HEALTH

Figure 2-3. Urinary Cadmium ($\mu\text{g/g}$ creatinine) and Renal Cortex Cadmium Concentration ($\mu\text{g/g}$ wet tissue) Predicted by the Cadmium Pharmacokinetic Model*

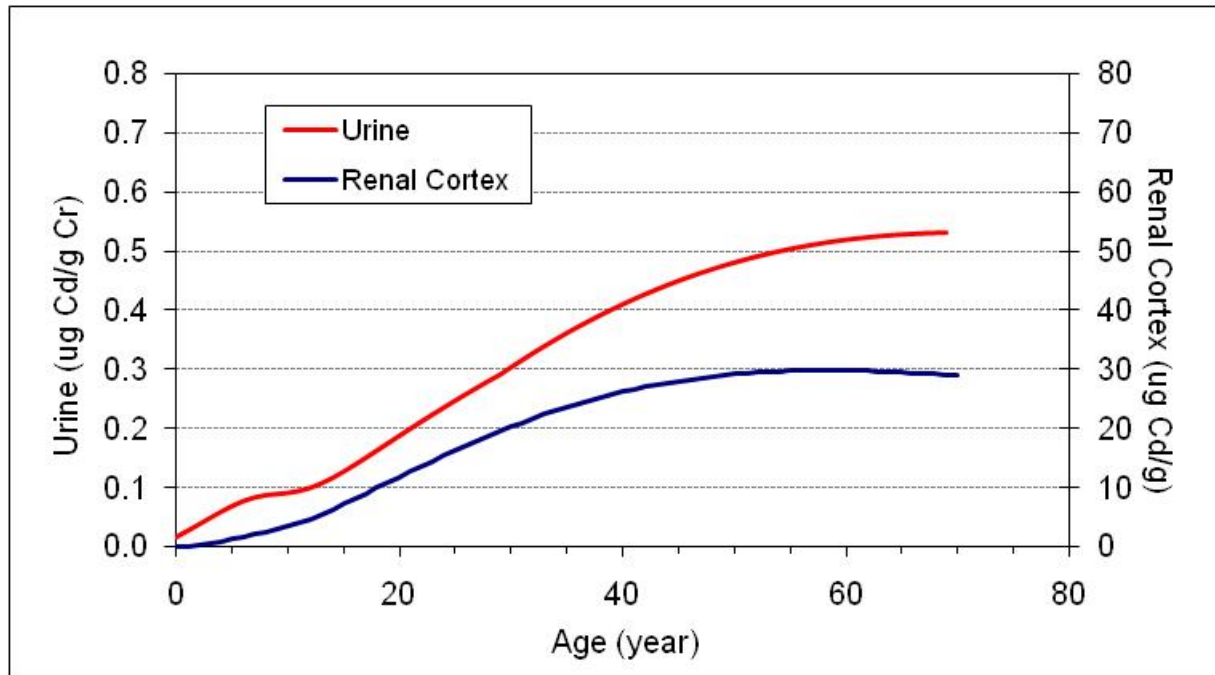

*Shown is a simulation of peak renal cadmium concentration (at age 55) in females based on a chronic intake of $0.33 \mu\text{g Cd/kg/day}$.

2. RELEVANCE TO PUBLIC HEALTH

Dose units expressed as cadmium intake ($\mu\text{g}/\text{kg}/\text{day}$), urinary cadmium excretion ($\mu\text{g}/\text{g}$ creatinine), or kidney tissue cadmium ($\mu\text{g}/\text{g}$ cortex) were interconverted by iterative pharmacokinetic model simulations of constant intakes for the life-time to age 55 years, the age at which renal cortex cadmium concentrations are predicted to reach their peak when the rate of intake ($\mu\text{g}/\text{kg}/\text{day}$) is constant.

The dietary cadmium intakes which would result in urinary cadmium levels of 1.34 and 0.5 $\mu\text{g}/\text{g}$ creatinine (UCD_{10} and UCDL_{10}) are 0.97 and 0.33 $\mu\text{g}/\text{kg}/\text{day}$ in females and 2.24 and 0.70 $\mu\text{g}/\text{kg}/\text{day}$ in males. The dietary concentration associated with the UCDL_{10} in females (0.33 $\mu\text{g}/\text{kg}/\text{day}$) was divided by an uncertainty factor of 3 for human variability resulting in a chronic-duration oral MRL of 0.1 $\mu\text{g}/\text{kg}/\text{day}$ (1×10^{-4} mg Cd/kg/day). The UCD is based on several large-scale environmental exposure studies that likely included sensitive subpopulations; however, there is concern that individuals with diabetes may be especially sensitive to the renal toxicity of cadmium (Åkesson et al. 2005; Buchet et al. 1990) and diabetics were excluded from a number of the human studies, and thus, an uncertainty factor of 3 was used.

The urinary cadmium point of departure used as the basis of the MRL (0.5 $\mu\text{g}/\text{g}$ creatinine) is approximately 2-fold higher than the geometric mean urinary cadmium concentrations in the United States, which is 0.247 $\mu\text{g}/\text{g}$ creatinine for adults 20 years and older (CDC 2011). The MRL of 0.1 $\mu\text{g}/\text{kg}/\text{day}$ is lower than the estimated age-weighted cadmium intake of 0.3 $\mu\text{g}/\text{kg}/\text{day}$ (estimated from data in Choudhury et al. 2001). Because this intake is derived from the cadmium dietary exposure model which estimates food cadmium concentrations from national survey data and food consumption patterns, it should not be considered a precise value. A better comparison would be between the mean urinary cadmium concentration in adults living in the United States (0.247 $\mu\text{g}/\text{g}$ creatinine) and the MRL expressed as a urinary cadmium concentration (0.2 $\mu\text{g}/\text{g}$ creatinine).

2. RELEVANCE TO PUBLIC HEALTH

This page is intentionally blank.

3. HEALTH EFFECTS

3.1 INTRODUCTION

The primary purpose of this chapter is to provide public health officials, physicians, toxicologists, and other interested individuals and groups with an overall perspective on the toxicology of cadmium. It contains descriptions and evaluations of toxicological studies and epidemiological investigations and provides conclusions, where possible, on the relevance of toxicity and toxicokinetic data to public health.

A glossary and list of acronyms, abbreviations, and symbols can be found at the end of this profile.

The form of cadmium and the route of exposure can greatly affect the absorption and distribution of cadmium to various target sites, and therefore, the concentration at the target site and the severity of the observed effect. The mechanism of action, however, involves the cadmium cation's effect on the target site, and the cation is the same regardless of the anionic species. For inhaled cadmium compounds, the size of the cadmium particle (i.e., fume or aerosol) can also affect the absorption and distribution. For oral exposures, cadmium chloride is most often tested in animal studies because of its high water solubility and the resulting high concentrations of cadmium delivered to target sites. Studies on cadmium bound to metallothionein are also of interest because cadmium-metallothionein complexes may have different toxic profiles and are found in relatively high levels in organ meats (e.g., liver and kidney). Cadmium oxide and cadmium carbonate, which are relatively insoluble in water (but may dissolve at gastric pH), appear to be similar in absorption and toxicity to soluble cadmium. There are fewer studies available on other forms of cadmium including insoluble forms in water such as cadmium sulfide (a yellow pigment) and cadmium selenium sulfide (a red pigment), and a soluble form, cadmium sulfate, which is less soluble in a closed air system where there is a limited amount of dissolved carbon dioxide. Chapter 4 lists the chemical and physical properties of several cadmium compounds.

3.2 DISCUSSION OF HEALTH EFFECTS BY ROUTE OF EXPOSURE

To help public health professionals and others address the needs of persons living or working near hazardous waste sites, the information in this section is organized first by route of exposure (inhalation, oral, and dermal) and then by health effect (death, systemic, immunological, neurological, reproductive, developmental, genotoxic, and carcinogenic effects). These data are discussed in terms of three exposure periods: acute (14 days or less), intermediate (15–364 days), and chronic (365 days or more).

3. HEALTH EFFECTS

Levels of significant exposure for each route and duration are presented in tables and illustrated in figures. The points in the figures showing no-observed-adverse-effect levels (NOAELs) or lowest-observed-adverse-effect levels (LOAELs) reflect the actual doses (levels of exposure) used in the studies. LOAELs have been classified into "less serious" or "serious" effects. "Serious" effects are those that evoke failure in a biological system and can lead to morbidity or mortality (e.g., acute respiratory distress or death). "Less serious" effects are those that are not expected to cause significant dysfunction or death, or those whose significance to the organism is not entirely clear. ATSDR acknowledges that a considerable amount of judgment may be required in establishing whether an end point should be classified as a NOAEL, "less serious" LOAEL, or "serious" LOAEL, and that in some cases, there will be insufficient data to decide whether the effect is indicative of significant dysfunction. However, the Agency has established guidelines and policies that are used to classify these end points. ATSDR believes that there is sufficient merit in this approach to warrant an attempt at distinguishing between "less serious" and "serious" effects. The distinction between "less serious" effects and "serious" effects is considered to be important because it helps the users of the profiles to identify levels of exposure at which major health effects start to appear. LOAELs or NOAELs should also help in determining whether or not the effects vary with dose and/or duration, and place into perspective the possible significance of these effects to human health.

The significance of the exposure levels shown in the Levels of Significant Exposure (LSE) tables and figures may differ depending on the user's perspective. Public health officials and others concerned with appropriate actions to take at hazardous waste sites may want information on levels of exposure associated with more subtle effects in humans or animals (LOAELs) or exposure levels below which no adverse effects (NOAELs) have been observed. Estimates of levels posing minimal risk to humans (Minimal Risk Levels or MRLs) may be of interest to health professionals and citizens alike.

Levels of exposure associated with carcinogenic effects (Cancer Effect Levels, CELs) of cadmium are indicated in [Tables 3-1](#) and [3-6](#) and [Figures 3-1](#) and [3-2](#). Because cancer effects could occur at lower exposure levels, [Figure 3-1](#) also shows a range for the upper bound of estimated excess risks, ranging from a risk of 1 in 10,000 to 1 in 10,000,000 (10^{-4} to 10^{-7}), as developed by EPA.

A User's Guide has been provided at the end of this profile (see Appendix B). This guide should aid in the interpretation of the tables and figures for Levels of Significant Exposure and the MRLs.

3. HEALTH EFFECTS

3.2.1 Inhalation Exposure

The information in this section on health effects of inhalation exposure to cadmium in humans is derived from studies of workers exposed to cadmium fume or dusts in industries such as smelting, battery manufacturing, soldering, and pigment production. Adverse effects of human exposure to cadmium were first established among workers in a cadmium battery factory (Friberg 1950). Workers are exposed occupationally to cadmium primarily by inhalation of fumes or dust. Some gastrointestinal tract exposure may also occur when dust is removed from the lungs by mucociliary clearance and subsequently swallowed, or by ingestion of dust on hands, cigarettes, or food (Adamsson et al. 1979). In experiments with animals, some ingestion may also occur from inhalation exposures by mucociliary clearance or from animal grooming. The primary form of cadmium in occupational exposures is cadmium oxide. Experimental studies in laboratory animals have used cadmium oxide, cadmium chloride, and occasionally other forms of cadmium such as cadmium sulfide and cadmium sulfate. In general, the different forms of cadmium have similar toxicological effects by the inhalation route, although quantitative differences may exist from different absorption and distribution characteristics, particularly for the less soluble cadmium pigments such as cadmium sulfide and cadmium selenium sulfide (Buckley and Bassett 1987b; Klimisch 1993; Oldiges and Glaser 1986; Oldiges et al. 1989; Rusch et al. 1986).

Smokers inhale cadmium, but studies of cadmium exposure in the general population are considered in Section 3.2.2 because the primary route of exposure for the general population is through the diet. Also, the many other toxic compounds in cigarette smoke make it difficult to attribute specific adverse effects of smoking to the inhalation of cadmium.

3.2.1.1 Death

Numerous studies have shown that acute inhalation exposure to cadmium can cause death in humans and animals. In humans, several fatal inhalation exposures have occurred in occupational accidents. During the acute exposure, the general symptoms are relatively mild but, within a few days following exposure, severe pulmonary edema and chemical pneumonitis develop, leading to death due to respiratory failure (Beton et al. 1966; Lucas et al. 1980; Patwardhan and Finckh 1976; Seidal et al. 1993). The cadmium concentration in air was not measured in these cases of accidental death in humans. However, the lung concentrations of cadmium in the men who died from these accidental acute exposures were measured. In micrograms of cadmium per gram wet weight (w/w) of lung tissue ($\mu\text{g/g}$), Patwardhan and Finckh (1976) reported 1.5 $\mu\text{g/g}$, Beton et al. (1966) reported 2.5 $\mu\text{g/g}$, Barrett et al. (1947) reported 3.5 $\mu\text{g/g}$, and Lucas et al. (1980) reported 4.7 $\mu\text{g/g}$. Based upon estimates of the percentage of inhaled cadmium fume

3. HEALTH EFFECTS

that would be retained in the lungs, Barrett et al. (1947) calculated an exposure of 2,500 minutes \times mg/m³ in air would be fatal to humans. Beton et al. (1966) used a similar technique to estimate that an exposure to cadmium oxide in air of 8.63 mg/m³ for 5 hours led to the fatal deaths of the five workers with cadmium lung burdens of 2.5 μ g/g. The lower lung concentrations reported by Patwardhan and Finckh (1976) prompted Elinder (1986b) to estimate that an exposure of 1–5 mg/m³ for 8 hours could be immediately dangerous. These estimates of air concentrations, however, are based on a number of uncertain assumptions concerning the duration of exposure and the retention of cadmium in the human lung being similar to that found in animal studies (Barrett et al. 1947; Elinder 1986b). No studies on deaths in humans from intermediate inhalation exposures were found. In a study on chronic exposures, Friberg (1950) attributes the deaths of 2 workers to exposure to cadmium dust in the air averaging 6.8 mg Cd/m³ (range 3–15 mg/m³). One worker was 57 years old at death (after 14 years of exposure to the dust) and the other was 60 years old at death (after 25 years of exposure to the dust). A detailed postmortem evaluation for the 60-year-old worker showed the presence of emphysema and the occurrence of hyaline casts in renal tubules, as well as slight nephrotic changes. Pneumonia was the direct cause of death as an acute complication of chronic bronchitis and pulmonary emphysema. The exposure estimate of 6.8 mg Cd/m³ is from only six samples taken in 1946. The conditions in earlier years were thought to be similar, but this exposure value is, at best, a very rough approximation of the actual exposures spanning 34 years.

Acute inhalation of cadmium oxide fumes has also led to death in rats, mice, rabbits, guinea pigs, dogs, and monkeys, with the mortality rate apparently being directly proportional to the product of the duration of exposure and the concentration of inhaled cadmium (Barrett et al. 1947). The most reliable LC₅₀ (lethal concentration, 50% kill) (at 7 days) established by this study was 500 minute-mg cadmium oxide/m³ for rats, equivalent to a 15-minute exposure to 30 mg Cd/m³ (Barrett et al. 1947). Rusch et al. (1986) demonstrated high mortality rates in the Sprague-Dawley rat from a 2-hour exposure to cadmium fumes at 112 mg Cd/m³ (25 of 32 died within 1 week). A 2-hour exposure to a different form of cadmium, cadmium carbonate, at 132 mg Cd/m³ resulted in considerably lower mortality (3 of 22 died by day 30). No deaths resulted from a 2-hour exposure to cadmium sulfide at 99 mg Cd/m³ or cadmium selenium sulfide (cadmium red pigment) at 97 mg Cd/m³. Grose et al. (1987) reported 2 out of 36 rats died from a 2-hour, nose-only inhalation exposure to only 0.45 mg Cd/m³ of cadmium oxide dusts, but the statistical significance of this low rate of mortality was not reported. A 3-day, 1-hour/day exposure to cadmium chloride aerosol at 61 mg Cd/m³ resulted in the death of 17 of 18 rats exposed (Snider et al. 1973). In another study, no deaths were observed in rats from a cadmium yellow (cadmium sulfide) pigment exposure 6 hours/day for 10 days at 6.29 mg Cd/m³ (Klimisch 1993). Thus, it appears that in acute exposures, the relatively more soluble cadmium chloride, cadmium oxide fume, and cadmium

3. HEALTH EFFECTS

carbonate compounds are more toxic than the relatively less soluble cadmium sulfide compounds (Klimisch 1993; Rusch et al. 1986). Rusch et al. (1986) attribute this difference to higher lung absorption and retention times for the more soluble compounds, and greater mucociliary clearance for the less-soluble pigments. Glaser et al. (1986), however, demonstrated that toxicity does not strictly correlate with solubility, and that solubility of cadmium oxide in biological fluids may be greater than its solubility in water. In hamsters, Henderson et al. (1979) reported that a 30-minute exposure to 10.1 mg Cd/m³ from cadmium chloride resulted in the death of 3 of 30 animals by day 6 postexposure. In rabbits, Friberg (1950) reported an LC₅₀ (by day 14) from a 4-hour exposure to cadmium metal dusts at 28.4 mg Cd/m³. Barrett et al. (1947) also reported LC₅₀ values for cadmium oxide fume of 940 mg Cd/m³ for a 14-minute exposure in the monkey, 46.7 mg/m³ for a 15-minute exposure in the mouse, 204 mg Cd/m³ for a 15-minute exposure in the guinea pig, and 230 mg Cd/m³ for a 15-minute exposure in the dog. However, the authors report that these LC₅₀ values are only approximations because of insufficiencies in the data or the small numbers of animals used.

At longer durations of exposure, lower concentrations cause lethality in rats. Cadmium oxide dust resulted in the deaths of 100% of the females at 1 mg Cd/m³ for 5 hours/day, 5 days/week for 20 weeks, (Baranski and Sitarek 1987), and of 5 of 12 female rats at only 0.105 mg Cd/m³ 22 hours/day, 7 days/week for 63 days (Oldiges and Glaser 1986). Continuous inhalation exposure to cadmium oxide dust at 0.105 mg Cd/m³ (i.e., 24 hours/day) for 63 days resulted in 5 of 12 deaths in female rats (Prigge 1978a). Five of 54 males died from a cadmium chloride exposure to 1.06 mg Cd/m³ for 62 days, 5 days/week, 6 hours/day (Kutzman et al. 1986). Kutzman et al. (1986) determined that the concentration times hours of exposure to produce 50% mortality in rats was 390 mg-hour/m³ (males) and 489 mg-hour/m³ (females). Takenaka et al. (1983) reported that cadmium chloride at 0.0508 mg Cd/m³ 23 hours/day, 7 days/week for 18 months resulted in the death of 5 of 40 male rats.

Oldiges et al. (1989) evaluated the long-term effects in rats of inhaling cadmium as either cadmium chloride, cadmium sulfate, cadmium sulfide, or cadmium oxide. Rats were exposed to aerosols in nearly continuous exposures of 22 hours/day, 7 days/week for 18 months. An observation period of 12 months followed the exposure period. Oldiges et al. (1989) recorded mortality as exceeding 25% of the test animals during the exposure period or 75% of the test animals during the observation period. If either 25 or 75% mortality occurred, the exposure period or the observation period, respectively, was terminated. The results showed that cadmium chloride at 0.030 mg Cd/m³ was lethal to >75% of the male and female rats by 12 months of exposure; cadmium oxide dusts at 0.090 mg Cd/m³ were lethal for >25% of the males by 7 months and 25% of the females by 11 months of exposure; cadmium oxide fume at the

3. HEALTH EFFECTS

highest dose of 0.03 mg Cd/m³ did not result in >25% mortality during exposure or 75% during the postexposure period; cadmium sulfate at 0.090 mg Cd/m³ was lethal for >25% of the males during the exposure and for >75% of the females by 14 months following exposure; and cadmium sulfide at 0.090 mg Cd/m³ was not lethal during the exposure period but was lethal to >75% of the males and females by 12 months postexposure. In these chronic studies, cadmium's lethal effects differed among the chemical forms in the following order from most to least toxic: cadmium chloride>cadmium sulfate ≈ cadmium oxide dust>cadmium sulfide, but lethality still occurred from all forms of cadmium. Oldiges and Glaser (1986) report that in their chronic studies and at the doses tested, cadmium toxicity appeared to be more related to the long-term lung retention of the bioavailable amounts of cadmium than to a simple function of solubility in water. Representative LOAEL and LC₅₀ values for lethality in each species and duration category are recorded in [Table 3-1](#) and are plotted in [Figure 3-1](#).

3.2.1.2 Systemic Effects

The highest NOAEL values and all LOAEL values from each reliable study for systemic effects in each species and duration category are recorded in [Table 3-1](#) and plotted in [Figure 3-1](#).

Respiratory Effects. In humans, inhalation exposure to high levels of cadmium oxide fumes or dust is intensely irritating to respiratory tissue, but symptoms can be delayed. During and immediately after (up to 2 hours) an acute exposure for 5 hours of 8.63 mg/m³, Beton et al. (1966) reported that there were few symptoms of toxicity limited to coughing and slight irritation of the throat and mucosa. From 4 to 10 hours postexposure, influenza-like symptoms began to appear, including cough, tight chest, pain in chest on coughing, dyspnea, malaise, ache, chilling, sweating, shivering, and aching pain in back and limbs. From 8 hours to 7 days postexposure, more advanced stages of pulmonary response included severe dyspnea and wheezing, chest pain and precordial constriction, persistent cough, weakness and malaise, anorexia, nausea, diarrhea, nocturia, abdominal pain, hemoptysis, and prostration. Acute, high-level exposures can be fatal (see Section 3.2.1.1), and those who survive may have impaired lung function for years after a single acute exposure. A 34-year-old worker exposed to cadmium fume from soldering for 1 hour (dose not determined) had persistent impaired lung function when examined 4 years following the exposure (Barnhart and Rosenstock 1984). Initial symptoms were dyspnea, cough, myalgia, and fever. An initial chest X-ray revealed infiltrates. Townshend (1982) reports the case of a male welder who developed acute cadmium pneumonitis from a single exposure (dose not determined). Nine years after the exposure, this worker continued to show signs of progressive pulmonary fibrosis and

Table 3-1 Levels of Significant Exposure to Cadmium - Inhalation

Key to Figure ^a	Species (Strain)	Exposure/Duration/Frequency (Route)	System	NOAEL (mg/m ³)	LOAEL		Reference Chemical Form	Comments
					Less Serious (mg/m ³)	Serious (mg/m ³)		
ACUTE EXPOSURE								
Death								
1	Human	5 hr (occup)				8.63 M (5 male workers died after a 5 hour exposure)	Beton et al. 1966 CdO fume	
2	Rat (NS)	10-15 min				30 (LC50 at 7 days)	Barrett et al. 1947 CdO fume	
3	Rat (Fischer- 344)	6.2 hr/d 5 d/wk 2 wk				8.8 (100% mortality by day 6)	NTP 1995 CdO	
4	Rat (Sprague-Dawley)	2 hr				112 (25/32 died within 1 week)	Rusch et al. 1986 CdO fume	
5	Rat (Sprague-Dawley)	3 d 1 hr/d				61 M (17/18 died within 3 days)	Snider et al. 1973 CdCl ₂	
6	Mouse (B6C3F1)	6.2 hr/d 5 d/wk 2 wk				8.8 (100% mortality by day 7)	NTP 1995 CdO	
7	Rabbit (NS)	4 hr				28.4 (LC50 at 14 days)	Friberg 1950 Cd metal dust	

Table 3-1 Levels of Significant Exposure to Cadmium - Inhalation

(continued)

Key to Figure ^a	Species (Strain)	Exposure/ Duration/ Frequency (Route)	System	NOAEL (mg/m ³)	LOAEL		Reference Chemical Form	Comments
					Less Serious (mg/m ³)	Serious (mg/m ³)		
Systemic								
8	Rat (Long-Evans)	1 hr	Resp				5 M (pulmonary edema, enzyme changes associated with type 2 cell hyperplasia)	Boudreau et al. 1989 CdCl ₂
9	Rat (Wistar)	3 hr	Resp		0.4 M (mild hypercellularity at the bronchoalveolar junction and in adjacent alveoli)		4.6 M (persistent focal interstitial thickening, increased collagen, general hypercellularity)	Buckley and Bassett 1987b CdO dust
			Bd Wt	0.4 M	4.6 M (15% decreased body weight)			
10	Rat (Sprague- Dawley)	1 hr	Resp				6.5 M (severe pneumonitis)	Bus et al. 1978 CdCl ₂
			Bd Wt		6.5 M (10.8% decreased body weight)			
11	Rat (Sprague- Dawley)	2 hr	Resp	0.45 M			4.5 M (moderate to severe pneumonitis, hemorrhage, edema)	Grose et al. 1987 CdCl ₂
			Bd Wt			4.5 M (20% decreased body weight)		

Table 3-1 Levels of Significant Exposure to Cadmium - Inhalation

(continued)

Key to Figure	Species (Strain)	Exposure/Duration/Frequency (Route)	System	NOAEL (mg/m ³)	LOAEL		Reference Chemical Form	Comments
					Less Serious (mg/m ³)	Serious (mg/m ³)		
12	Rat (Sprague-Dawley)	2 hr	Resp		0.45 M (significant increased absolute and relative lung weight)	4.5 M (severe pneumonitis, hyperplasia of type 2 cells and fibroblasts)	Grose et al. 1987 CdO dust	
			Bd Wt	0.45 M				
13	Rat (Lewis)	1-6 wk 5 d/wk 3 hr/d	Resp			1.6 M (interstitial pneumonitis)	Hart 1986 CdO dust	
14	Rat (Wistar)	10 d 6 hr/d	Bd Wt	0.17 M			Klimisch 1993 CdCl ₂	No histopathological examination.
15	Rat (Wistar)	10 d 6 hr/d	Bd Wt	6.29 M			Klimisch 1993 CdS	No histopathological examination.
16	Rat (Fischer- 344)	6.2 hr/d 5 d/wk 2 wk	Resp		0.88 F (degeneration of nasal olfactory epithelium)	8.8 (marked necrosis of alveolar ducts)	NTP 1995 CdO	
				0.088 ^b (alveolar histiocytic infiltrate and focal inflammation in alveolar septa)				
			Hepatic	2.6				
	Renal	2.6						

Table 3-1 Levels of Significant Exposure to Cadmium - Inhalation

(continued)

Key to Figure ^a	Species (Strain)	Exposure/Duration/Frequency (Route)	System	NOAEL (mg/m ³)	LOAEL		Reference Chemical Form	Comments
					Less Serious (mg/m ³)	Serious (mg/m ³)		
17	Rat (Sprague-Dawley)	2 hr	Resp				6 M (alveolar type 1 cell damage and necrosis)	Palmer et al. 1986 CdCl ₂
			Endocr	6 M				
			Bd Wt	6 M				
18	Rat (Sprague-Dawley)	2 hr	Gastro		132	(erosions of the stomach)		Rusch et al. 1986 CdCO ₃
19	Rat (Sprague-Dawley)	5, 10, or 15 d 1 hr/d	Resp				6.1 M (emphysema)	Snider et al. 1973 CdCl ₂
20	Rat (Sprague-Dawley)	3 d 1 hr/d	Resp				61 M (pulmonary hemorrhage)	Snider et al. 1973 CdCl ₂
21	Mouse (B6C3F1)	6.2 hr/d 5 d/wk 2 wk	Resp		0.88	(fibrosis and inflammation around the alveolar ducts, necrosis of the alveolar duct epithelium)		NTP 1995 CdO
					0.088	(histiocytic infiltrates)		
			Hepatic	2.6				
	Renal	2.6						

Table 3-1 Levels of Significant Exposure to Cadmium - Inhalation

(continued)

Key to Figure ^a	Species (Strain)	Exposure/Duration/Frequency (Route)	System	NOAEL (mg/m ³)	LOAEL		Reference Chemical Form	Comments
					Less Serious (mg/m ³)	Serious (mg/m ³)		
22	Hamster (Golden Syrian)	30 min	Resp		1.1 (moderate increase in PMN, 2-fold increase in acid phosphatase)	10.1 (severe pneumonitis)	Henderson et al. 1979 CdCl ₂	
23	Rabbit (New Zealand)	2 hr	Resp		4.5 M (mild, multifocal interstitial pneumonitis)		Grose et al. 1987 CdCl ₂	
24	Rabbit (New Zealand)	2 hr	Resp		0.45 M (increase in alveolar macrophages)	4.5 M (multifocal interstitial pneumonitis)	Grose et al. 1987 CdO dust	
			Bd Wt		0.45 M (unspecified decrease in body weight)			
Immuno/ Lymphoret								
25	Mouse (Swiss)	2 hr		0.11 F	0.19 F (decreased humoral immune response)		Graham et al. 1978 CdCl ₂	
26	Mouse (C57Bl/6)	60 min			0.88 F (reduction in spleen lymphocyte viability [35%], numbers, and humoral response (75%))		Krzystyniak et al. 1987 CdCl ₂	
INTERMEDIATE EXPOSURE								
Death								
27	Rat (Wistar)	20 wk 5 d/wk 5 hr/d				1 F (13/13 died by week 20)	Baranski and Sitarek 1987 CdO dusts	

Table 3-1 Levels of Significant Exposure to Cadmium - Inhalation

(continued)

Key to Figure	Species (Strain)	Exposure/Duration/Frequency (Route)	System	NOAEL (mg/m ³)	LOAEL		Reference Chemical Form	Comments	
					Less Serious (mg/m ³)	Serious (mg/m ³)			
28	Rat (Fischer 344)	62 d 5 d/wk 6 hr/d					2.13 M (100% mortality by day 45)	Kutzman et al. 1986 CdCl ₂	
29	Rat (Wistar)	6 mo 40 hr/wk					0.09 (> 75% mortality by 11-12 months postexposure)	Oldiges et al. 1989 CdCl ₂	
30	Rat (Wistar)	6 mo 40 hr/wk					0.27 (> 75% mortality by 21-23 months postexposure)	Oldiges et al. 1989 CdS	
31	Rat (Wistar)	63d 24 hr/d					0.105 F (5/12 died)	Prigge 1978a CdO dust	
Systemic									
32	Rat (Wistar)	20 wk 5 d/wk 5 hr/d	Bd Wt	0.16 F			1 F (30-50% decreased body weight gain)	Baranski and Sitarek 1987 CdO dusts	
33	Rat (Wistar)	30 d 7 d/wk 22 hr/d	Resp		0.105 M (increased total bronchoalveolar macrophage numbers, leukocytes, and macrophage cytotoxicity)			Glaser et al. 1986 CdCl ₂	No histopathology examination.
			Hemato		0.105 M (45% increase in WBC)				

Table 3-1 Levels of Significant Exposure to Cadmium - Inhalation

(continued)

Key to Figure ^a	Species (Strain)	Exposure/ Duration/ Frequency (Route)	System	NOAEL (mg/m ³)	LOAEL		Reference Chemical Form	Comments
					Less Serious (mg/m ³)	Serious (mg/m ³)		
34	Rat (Wistar)	30 d 7 d/wk 22 hr/d	Resp		0.098 M (increased total bronchoalveolar macrophage numbers, leukocytes, and macrophage cytotoxicity)		Glaser et al. 1986 CdO dust	No histopathology examination.
			Hemato		0.098 M (45% increase in WBC)			
35	Rat (Wistar)	30 d 7 d/wk 22 hr/d	Resp		1.034 M (increased total bronchoalveolar macrophage numbers, leukocytes, and macrophage cytotoxicity)		Glaser et al. 1986 CdS	No histopathological examination.
			Hemato	1.034 M				
			Bd Wt	1.034 M				
36	Rat (Fischer 344)	62 d 5 d/wk 6 hr/d	Resp		1.06 M (marked fibrosis with significant increase in collagen)		Kutzman et al. 1986 CdCl ₂	
			Bd Wt	0.33	1.06	(14% decreased body weight)		

Table 3-1 Levels of Significant Exposure to Cadmium - Inhalation

(continued)

Key to Figure ^a	Species (Strain)	Exposure/ Duration/ Frequency (Route)	System	NOAEL (mg/m ³)	LOAEL		Reference Chemical Form	Comments
					Less Serious (mg/m ³)	Serious (mg/m ³)		
37	Rat (Fischer- 344)	6.33 hr/d 5 d/wk 13 wk	Resp	0.022 F	(epithelial degeneration in the larynx)	0.88	(marked inflammation and moderate fibrosis in interstitium around alveolar ducts and terminal bronchioles)	NTP 1995 CdO
				0.22	(Inflammation of nasal respiratory epithelium)			
			Cardio	0.88				
			Gastro	0.88				
			Hemato	0.88				
			Hepatic	0.88				
			Renal	0.88				
Bd Wt	0.88							
38	Rat (Fischer 344)	4 wks 5 d/wk 6 hr/d	Resp	0.1 M			Oberdorster et al. 1994 CdCl ₂	

Table 3-1 Levels of Significant Exposure to Cadmium - Inhalation

(continued)

Key to Figure ^a	Species (Strain)	Exposure/ Duration/ Frequency (Route)	System	NOAEL (mg/m ³)	LOAEL		Reference Chemical Form	Comments
					Less Serious (mg/m ³)	Serious (mg/m ³)		
39	Rat (Wistar)	63 or 90 d 24 hr/d	Resp		0.025 F (proliferations, histiocytic cell granulomas)		Prigge 1978a CdO dust	
			Hemato		0.052 F (increased hemoglobin and hematocrit)			
			Hepatic	0.105 F				
			Renal	0.105 F				
			Bd Wt		0.105 F (11% decrease in body weight)			
		Metab		0.105 F (decreased blood pH and pO ₂ , increased pCO ₂)				
40	Rat (Wistar)	21 d Gd 1-21 24 hr/d	Resp		0.204 F (77% increased lung relative weight)		Prigge 1978b CdCl ₂	
			Hemato		0.204 F (8% increased hemoglobin, 5% increased hematocrit)			
			Hepatic	0.581 F				
			Renal	0.581 F				
			Bd Wt	0.394 F				

Table 3-1 Levels of Significant Exposure to Cadmium - Inhalation

(continued)

Key to Figure	Species (Strain)	Exposure/Duration/Frequency (Route)	System	NOAEL (mg/m ³)	LOAEL		Reference Chemical Form	Comments
					Less Serious (mg/m ³)	Serious (mg/m ³)		
41	Rat (Wistar)	21 d Gd 1-21 24 hr/d	Resp		0.204 F (70% increased lung relative weight)		Prigge 1978b CdCl ₂	
			Hemato		0.581 F (increased hemoglobin [12%], hematocrit [12%], total biliurin [2-fold])			
			Hepatic	0.581 F				
			Renal	0.581 F				
			Bd Wt		0.394 F (12% decreased maternal weight gain)			
42	Mouse (B6C3F1)	6.33 hr/d 5 d/wk 13 wk	Resp		0.088 M (Degeneration of nasal olfactory epithelium)		NTP 1995 CdO	
					0.022 (alveolar histiocytic infiltrates and squamous metaplasia of the larynx)			
			Cardio	0.88				
			Gastro	0.88				
			Hepatic	0.88				
			Renal	0.88				
			Bd Wt	0.88				

Table 3-1 Levels of Significant Exposure to Cadmium - Inhalation

(continued)

Key to Figure ^a	Species (Strain)	Exposure/ Duration/ Frequency (Route)	System	NOAEL (mg/m ³)	LOAEL		Reference Chemical Form	Comments
					Less Serious (mg/m ³)	Serious (mg/m ³)		
43	Mouse (BALB/c)	4 wks 5 d/wk 6 hr/d	Resp		0.1 M (increased neutrophils, LDH and beta-glucuronidase; pulmonary inflammation)		Oberdorster et al. 1994 CdCl ₂	
44	Rabbit (NS)	9 mo 21 d/mo 3 hr/d	Resp			4 (chronic pneumonia, emphysema)	Friberg 1950 Cd metal dust	
			Hemato		4 (eosinophilia, lower hemoglobin)			
			Renal			4 (proteinuria)		
45	Rabbit (NS)	7 mo 23 d/mo 3 hr/d	Resp			5.6 (emphysema)	Friberg 1950 Cd metal dust	
			Renal			5.6 (proteinuria in 6/10 surviving to the end of exposure)		
46	Rabbit (NS)	4-6 wk 5 d/wk 6 hr/d	Resp			0.4 M (lung interstitial inflammation, type 2 cell hyperplasia)	Johansson et al. 1984 CdCl ₂	

Table 3-1 Levels of Significant Exposure to Cadmium - Inhalation

(continued)

Key to Figure	Species (Strain)	Exposure/Duration/Frequency (Route)	System	NOAEL (mg/m ³)	LOAEL		Reference Chemical Form	Comments
					Less Serious (mg/m ³)	Serious (mg/m ³)		
Reproductive								
47	Rat (Wistar)	5 hr/d 5 d/wk 5 mo prematuring, mating, Gd 1-20		0.16 F			Baranski 1984 CdO	
48	Rat (Wistar)	20 wk 5 d/wk 5 hr/d			1 F (increased duration of estrous cycle)		Baranski and Sitarek 1987 CdO dusts	
49	Rat (Fischer 344)	62 d 5 d/wk 6 hr/d		1.06 M (t)			Kutzman et al. 1986 CdCl ₂	
50	Rat (Fischer- 344)	6.33 hr/d 5 d/wk 13 wk		0.22 M 0.22 F	0.88 M (decreased spermatid counts) 0.88 F (increased estrous cycle length)		NTP 1995 CdO	
Developmental								
51	Rat (Wistar)	5 hr/d 5 d/wk 5 mo prematuring, mating, Gd 1-20			0.02 F (altered performance on neurobehavioral tests)		Baranski 1984 CdO	

Table 3-1 Levels of Significant Exposure to Cadmium - Inhalation

(continued)

Key to Figure ^a	Species (Strain)	Exposure/Duration/Frequency (Route)	System	NOAEL (mg/m ³)	LOAEL		Reference Chemical Form	Comments	
					Less Serious (mg/m ³)	Serious (mg/m ³)			
52	Rat (Wistar)	4-5 mo 5 d/wk 5 hr/d			0.02	(altered performance on neurobehavioral tests)	0.16	(decreased pup viability)	Baranski 1985 CdO dusts
53	Rat (Sprague-Dawley)	6.27 hr/d 7 d/wk Gd 4-19		0.4 F	1.7 F	(decreased fetal body weight and reduced ossification)			NTP 1995 CdO
54	Rat (Wistar)	21 d Gd 1-21 24 hr/d			0.581	(9% decreased fetal body weight, 12% increase in fetal alkaline phosphatase)			Prigge 1978b CdCl ₂
55	Mouse (Swiss)	6.27 hr/d 7 d/wk Gd 4-17		0.04 F	0.4 F	(decreased fetal body weight)			NTP 1995 CdO
Cancer									
56	Rat (Wistar)	6 mo 40 hr/wk					0.09	(CEL: lung bronchioalveolar adenomas, adenocarcinomas, and squamous cell carcinomas)	Oldiges et al. 1989 CdCl ₂
CHRONIC EXPOSURE									
Death									
57	Human	1-34 yr 5 d/wk 8 hr/d (occup)					6.8 M	(2 fatalities from 14 years or 25 years of exposure to Cd dust)	Friberg 1950 Cd dust

Table 3-1 Levels of Significant Exposure to Cadmium - Inhalation

(continued)

Key to Figure	Species (Strain)	Exposure/Duration/Frequency (Route)	System	NOAEL (mg/m ³)	LOAEL		Reference Chemical Form	Comments
					Less Serious (mg/m ³)	Serious (mg/m ³)		
58	Rat (Wistar)	413-455 d 7 d/wk 22 hr/d					0.095 M (6/20 died)	Oldiges and Glaser 1986 CdSO ₄
59	Rat (Wistar)	18 mo 7 d/wk 22 hr/d					0.03 M (>75% mortality by 12 months postexposure)	Oldiges et al. 1989 CdCl ₂
60	Rat (Wistar)	18 mo 7 d/wk 22 hr/d					0.09 (more than 25% died after 7 months [M] and 11 months [F] of exposure)	Oldiges et al. 1989 CdO dust
61	Rat (Wistar)	18 mo 7 d/wk 22 hr/d					0.09 (>75% mortality after 12 months postexposure)	Oldiges et al. 1989 CdS
62	Rat (Wistar)	18 mo 7 d/wk 22 hr/d					0.09 M (>25% mortality by 14 months of exposure) 0.09 F (>75% by 11 months postexposure)	Oldiges et al. 1989 CdSO ₄
Systemic								
63	Human		Renal	0.0001 ^C F				Buchet et al. 1990; Jarup et al. 2000; Suwazono et al. 2006 form not specified

Table 3-1 Levels of Significant Exposure to Cadmium - Inhalation

(continued)

Key to Figure ^a	Species (Strain)	Exposure/Duration/Frequency (Route)	System	NOAEL (mg/m ³)	LOAEL		Reference Chemical Form	Comments
					Less Serious (mg/m ³)	Serious (mg/m ³)		
64	Human	4-24 yr 5 d/wk 8 hr/d (occup)	Resp	0.025			Edling et al. 1986 CdO fume	
65	Human	30 yr 5 d/wk 8 hr/d (occup)	Renal	0.033		0.067 (pronounced proteinuria)	Elinder et al. 1985b CdO fume	
66	Human	30 yr 5 d/wk 8 hr/d (occup)	Renal	0.0153 M		0.0379 M (100% incidence of proteinuria in the cohort exposed to this level for 21 years)	Falck et al. 1983 CdO fume	
67	Human	30 yr 5 d/wk 8 hr/d (occup)	Renal	0.017		0.023 (9.2% incidence of proteinuria)	Jarup et al. 1988 CdO dust	
68	Human	30 yr 5 d/wk 8 hr/d (occup)	Renal	0.0367 M			Mason et al. 1988 form not specified	
69	Human	30 yr 5 d/wk 8 hr/d (occup)	Renal	0.027			Thun et al. 1989 CdO dust or fume	

Table 3-1 Levels of Significant Exposure to Cadmium - Inhalation

(continued)

Key to Figure ^a	Species (Strain)	Exposure/Duration/Frequency (Route)	System	NOAEL (mg/m ³)	LOAEL		Reference Chemical Form	Comments
					Less Serious (mg/m ³)	Serious (mg/m ³)		
70	Rat (Wistar)	18 mo 7 d/wk 23 hr/d	Resp			0.0134 M (adenomatous hyperplasia in the bronchoalveolar area)	Takenaka et al. 1983 CdCl ₂	
			Bd Wt	0.0508 M				
Cancer								
71	Human	6 mo - 43 yr 7 d/wk 8 hr/d (occup)				0.1 M (CEL: 50-111 lung cancer deaths per 1000 workers; 45 year exposure)	Stayner et al. 1992 CdO dust or fumes	
72	Rat (Wistar)	18 mo 7 d/wk 22 hr/d				0.03 (CEL: lung bronchioalveolar adenomas, adenocarcinomas, and squamous cell carcinomas)	Oldiges et al. 1989 CdCl ₂	
73	Rat (Wistar)	18 mo 7 d/wk 22 hr/d				0.03 (CEL: lung bronchioalveolar adenomas, adenocarcinomas, and squamous cell carcinomas)	Oldiges et al. 1989 CdO dust	

Table 3-1 Levels of Significant Exposure to Cadmium - Inhalation

(continued)

Key to Figure ^a	Species (Strain)	Exposure/ Duration/ Frequency (Route)	System	NOAEL (mg/m ³)	LOAEL		Reference Chemical Form	Comments
					Less Serious (mg/m ³)	Serious (mg/m ³)		
74	Rat (Wistar)	18 mo 7 d/wk 22 hr/d				0.03	(CEL: lung bronchioalveolar adenomas, adenocarcinomas)	Oldiges et al. 1989 CdO fume
75	Rat (Wistar)	18 mo 7 d/wk 22 hr/d				0.09	(CEL: lung bronchioalveolar adenomas, adenocarcinomas, and squamous cell carcinomas)	Oldiges et al. 1989 CdS
76	Rat (Wistar)	18 mo 7 d/wk 22 hr/d				0.09	(CEL: lung bronchio-alveolar adenomas, adenocarcinomas, squamous cell carcinomas)	Oldiges et al. 1989 CdSO ₄

Table 3-1 Levels of Significant Exposure to Cadmium - Inhalation

(continued)

Key to Figure	Species (Strain)	Exposure/Duration/Frequency (Route)	System	NOAEL (mg/m ³)	LOAEL		Reference Chemical Form	Comments
					Less Serious (mg/m ³)	Serious (mg/m ³)		
77	Rat (Wistar)	18 mo 7 d/wk 23 hr/d				0.0134 M (CEL: lung epidermoid carcinomas, adenocarcinomas, and mucoepidermoid carcinomas)	Takenaka et al. 1983 CdCl ₂	

a The number corresponds to entries in Figure 3-1.

b Used to derive an acute-duration inhalation minimal risk level (MRL) of 0.00003 mg Cd/m³ (0.03 ug Cd/m³); concentration was adjusted for intermittent exposure (6.2 hours/day, 5 days/week) and divided by an uncertainty factor of 300 (10 for use of a LOAEL, 3 for extrapolation from animals to humans with dosimetric adjustment, and 10 for human variability).

c The chronic-duration inhalation MRL of 0.00001 mg Cd/m³ (0.01 ug Cd/m³) was calculated from the 95% lower confidence limit of the urinary cadmium level associated with a 10% increased risk of low molecular weight proteinuria (0.5 ug/g creatinine) estimated from a meta-analysis of select environmental exposure studies. An air concentration (together with an assumed dietary intake of 0.3 ug Cd/kg/day) which would result in this urinary cadmium concentration was estimated using the ICRP human respiratory tract model and a modification of the Nordberg-Kjellström pharmacokinetic model (see Appendix A for details on the meta-analysis and extrapolation to air concentration). This air concentration of 0.1 ug Cd/m³ was divided by an uncertainty factor of 3 for human variability and a modifying factor of 3.

Bd Wt = body weight; Cardio = cardiovascular; CEL = cancer effect level; d = day(s); Endocr = endocrine; F = Female; Gastro = gastrointestinal; Gd = gestational day; Hemato = hematological; hr = hour(s); Immuno/Lymphoret = immunological/lymphoreticular; LC50 = lethal concentration, 50% kill; LDH = lactate dehydrogenase; LOAEL = lowest-observed-adverse-effect level; M = male; min = minute(s); Metab = metabolic; mo = month(s); NOAEL = no-observed-adverse-effect level; NS = not specified; occup = occupational; PMN = polymorphonuclear leukocyte; Resp = respiratory; WBC = white blood cells; wk = week(s); yr = year(s)

Figure 3-1 Levels of Significant Exposure to Cadmium - Inhalation

Acute (≤14 days)

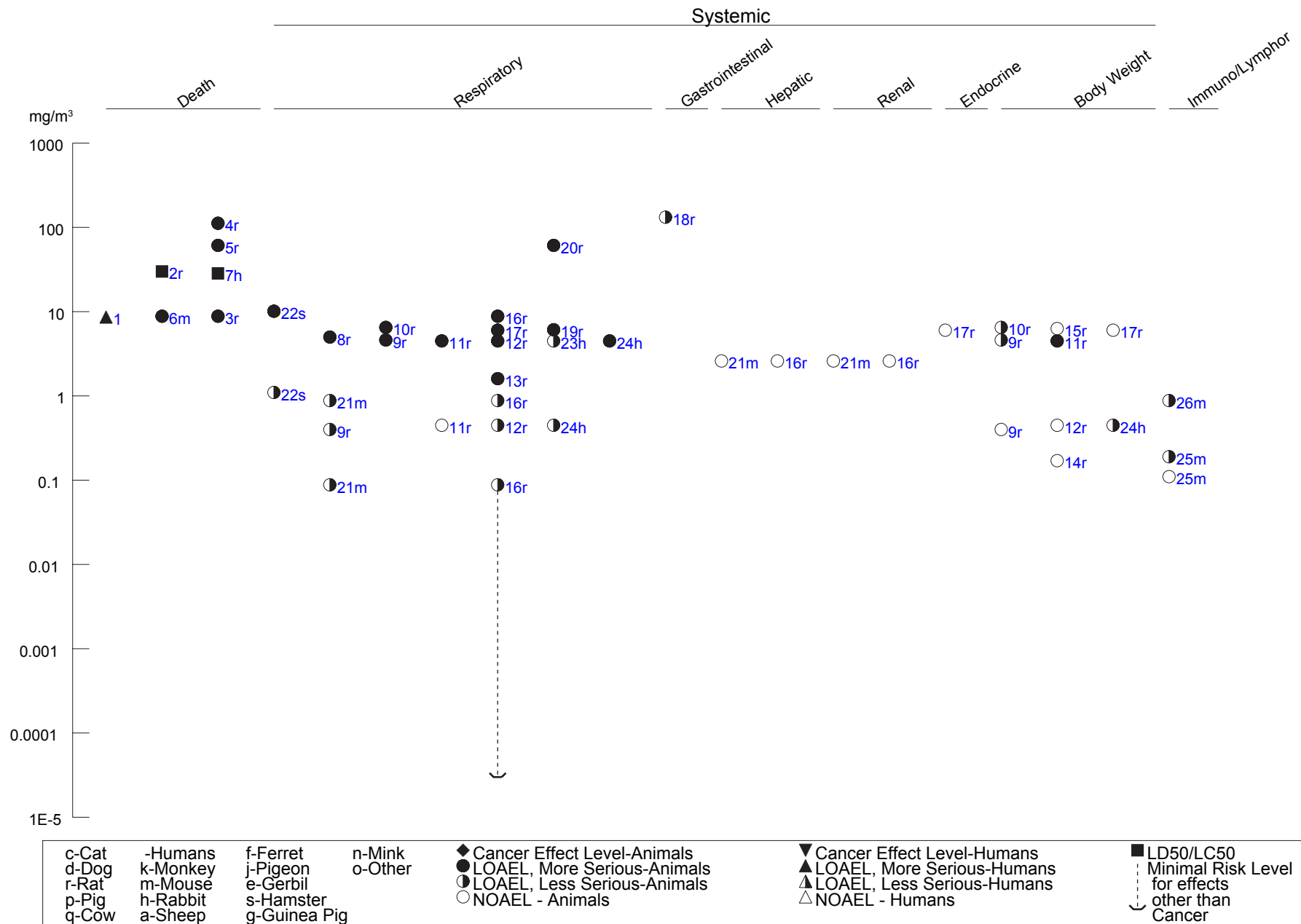

Figure 3-1 Levels of Significant Exposure to Cadmium - Inhalation (Continued)

Intermediate (15-364 days)

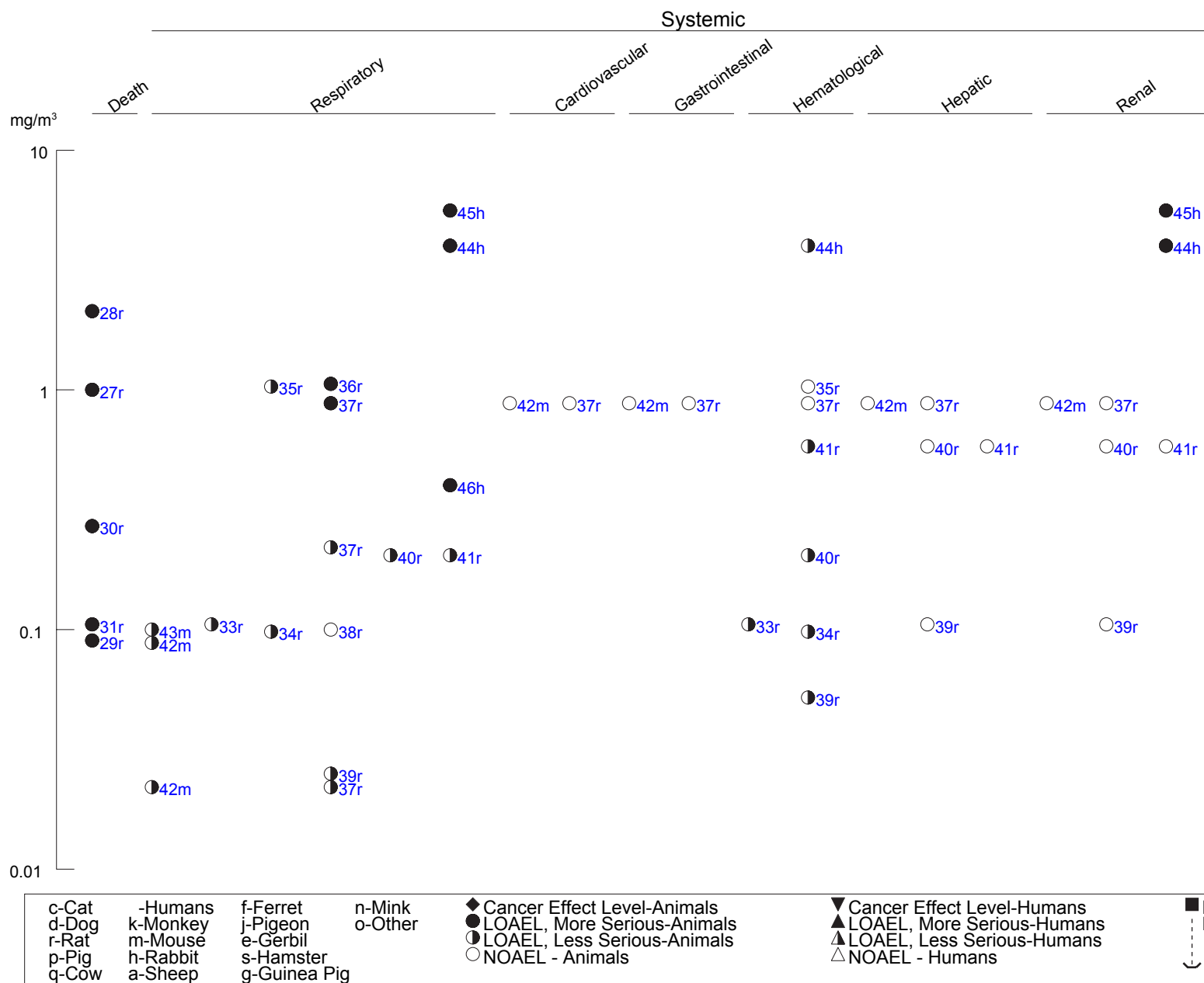

Figure 3-1 Levels of Significant Exposure to Cadmium - Inhalation (Continued)

Intermediate (15-364 days)

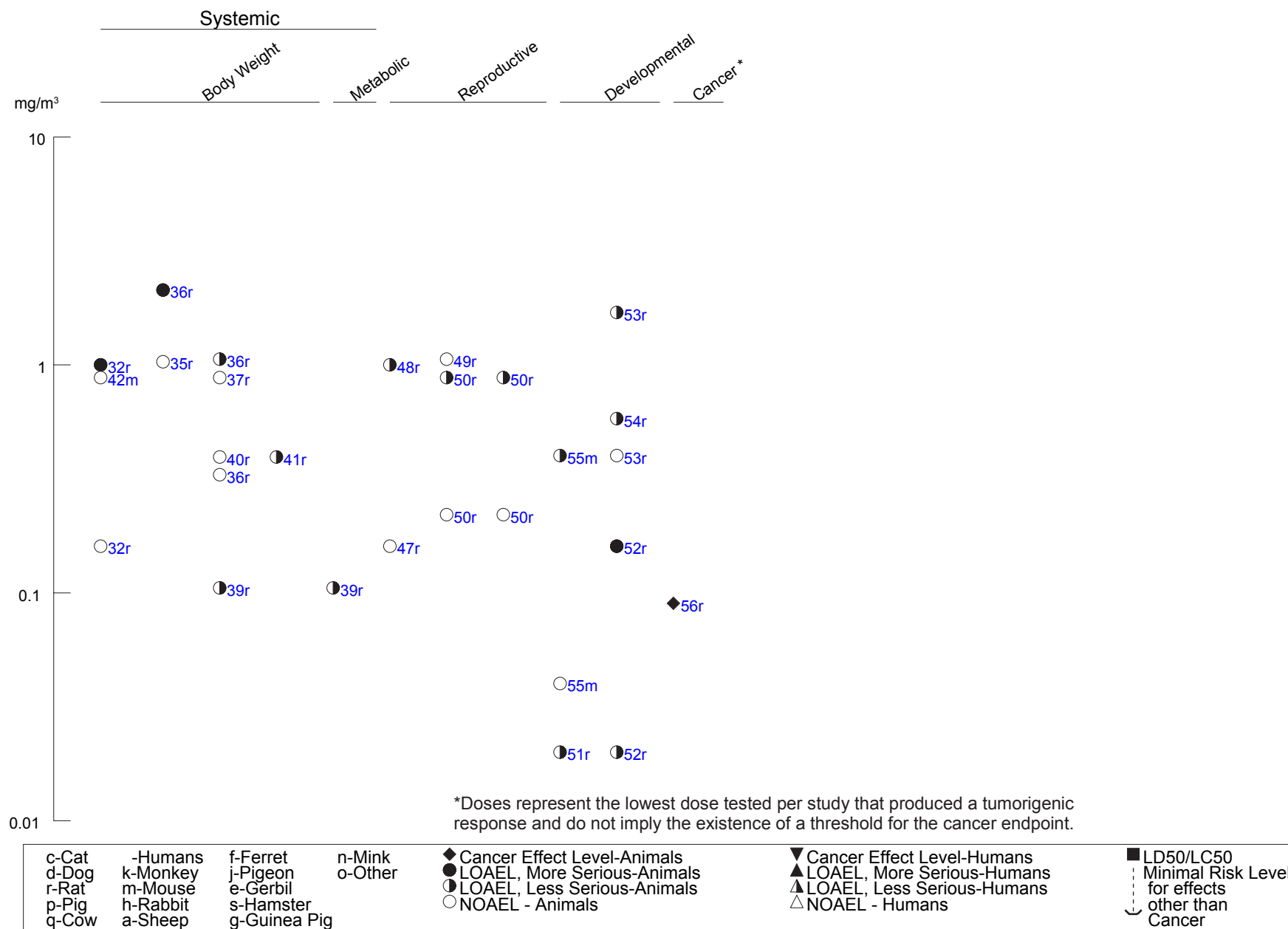
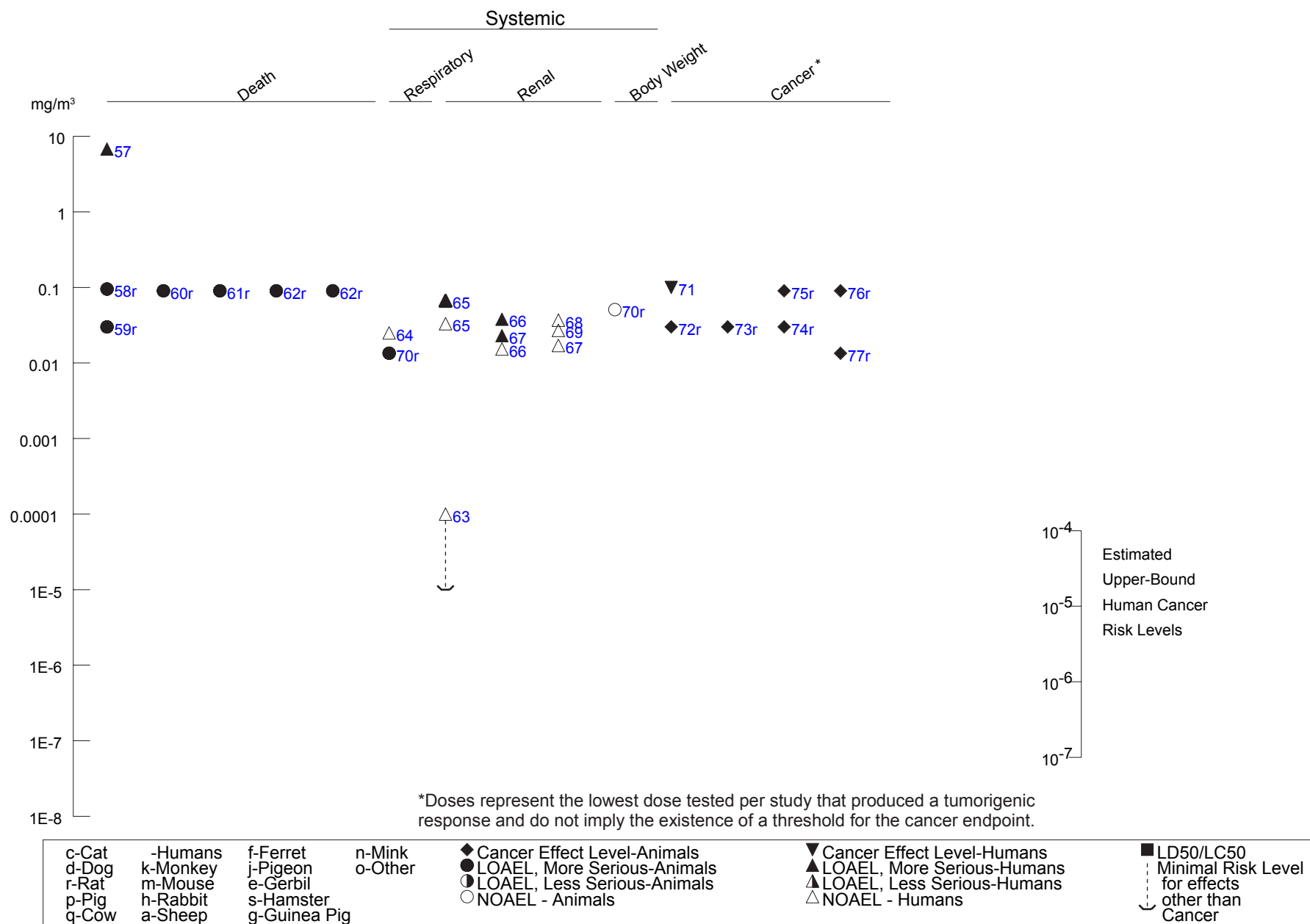

Figure 3-1 Levels of Significant Exposure to Cadmium - Inhalation (Continued)

Chronic (≥365 days)



3. HEALTH EFFECTS

had no improvement in respiratory function. Precise estimates of cadmium concentrations leading to acute respiratory effects in humans are not currently available.

The initial symptoms of respiratory distress observed in the higher acute exposures do not occur following lower-level, longer-term inhalation exposures (Friberg 1950). Longer-term occupational exposure to levels of cadmium below those causing lung inflammation, however, have been reported to cause emphysema and dyspnea in humans (Bonnell 1955; Friberg 1950; Lane and Campbell 1954; Smith et al. 1960). Kjellström et al. (1979) reported a significant increase in deaths due to respiratory diseases in cadmium-exposed battery factory workers exposed for >5 years.

A significant, dose-dependent excess in the ratio of observed to expected deaths from bronchitis (i.e., standardized mortality ratio [SMR]=434) but not emphysema was found among 6,995 men occupationally exposed to cadmium for an average of 11 years (Armstrong and Kazantzis 1983). The dose level was not determined.

The earlier occupational studies did not control for the health effects of cigarette smoking. There is some evidence that cadmium may accelerate the development of emphysema in smokers. Leduc et al. (1993) report a case history of a 59-year-old male worker who smoked a pack of cigarettes per day since age 16, but had no prior history of respiratory disease in 1975 until developing emphysema in 1979 after inhaling various concentrations of cadmium (range of 0.0164–1.192 mg/m³, mean of 0.446 mg/m³, about nine times the threshold value of 0.050 mg/m³) for 4 years as a furnace operator. Very high levels of cadmium in air samples at the workplace and in the patient's blood, urine, and lung tissue confirmed massive exposures. Lung-function tests declined rapidly, with a faster than usual onset of emphysema compared to other smokers. The mean concentration of cadmium in a removed section of lung was 580 µg/g dry tissue, compared to 14 µg/g in three unexposed controls matched for age, sex, and smoking habit who had also undergone resection of a bronchial carcinoma. The authors state that this case supports the hypothesis for an etiological role of cadmium fume inhalation in the development of emphysema.

More recent studies that controlled for smoking report lung impairment in cadmium-exposed workers (Chan et al. 1988; Cortona et al. 1992; Davison et al. 1988; Smith et al. 1976). Cortona et al. (1992) measured respiratory function parameters in 69 smoking and nonsmoking male subjects (average age 45) who were exposed to concentrations of 0.008–1.53 mg/m³ of cadmium fumes over a period of several years in a factory that produced cadmium alloys (silver-cadmium-copper). Forced Expiratory Volume (FEV), Forced Vital Capacity (FVC), Residual Volume (RV), Transfer Factor by the carbon

3. HEALTH EFFECTS

monoxide method (TLCO), and Transfer Coefficient (KCO) were measured in these exposed individuals. The study found that there were no significant differences in the FVC, FEV, TLCO, and KCO between the workers exposed to cadmium fumes and control (non-exposed) individuals. There was a significant increase in RV of >8% in exposed workers; this effect was notably greater in those with higher cumulative exposures to cadmium (>10%). It is uncertain how much of a factor on the increased RV was due to the tendency of smokers to develop an initial emphysematous alteration in lung tissue due to smoking.

Davison et al. (1988) evaluated lung function in 101 men who had manufactured copper-cadmium alloy in a plant in England for ≥ 1 years since 1926. The exposed men were compared to controls from the factory's other seven divisions matched for age and employment status. Smoking in exposed and control men was similar. Between 1951 and 1983, 933 measurements of airborne cadmium had been made, 697 with static samplers and 236 with personal samplers. The various sampling methods used before 1964 are no longer considered to be reliable, so estimates of air concentrations were made based on changes in production techniques, ventilation, levels of production, and discussions with occupational health physicians, industrial hygienist, the management, and the workers. Cadmium concentrations in air from 1926 to 1972 were determined to have declined from 0.6 to 0.156 mg/m³. In 1973, concentrations were 0.085 mg/m³; from 1974 to 1983, concentrations ranged from 0.034 to 0.058 mg/m³. The lung function of 77 of the men occupationally exposed to cadmium was significantly impaired compared to the unexposed controls, with the greatest abnormalities in the highest-dose group. Forced expiratory volume in one second, ratio of forced expiratory volume to forced vital capacity, transfer factor, or transfer coefficient were significantly lower than expected and radiographic total lung capacity, residual volume, and the ratio of these two were significantly higher than expected. The greatest abnormalities were observed in workers with the highest cumulative exposure and the highest liver cadmium levels. Regression of the lung transfer coefficient versus cadmium exposure indicated a linear relationship with no apparent threshold.

Smith et al. (1976) studied the pulmonary function of 17 high-exposure workers, 12 low-exposure workers, and 17 controls. Cadmium air concentrations where high-exposure subjects worked were >0.2 mg/m³. High-exposure subjects had worked at the plant a median of 26.4 years, with a maximum of 40.2 years, and low-exposure subjects had worked a median of 27.1 years, with a maximum of 34.8 years. Workers with high exposure to cadmium had significantly decreased the FVC compared to low-exposure workers and controls. Chest X-rays indicated mild or moderate interstitial fibrosis in 29% of high exposure workers. A dose-response relationship was found between FVC and urinary cadmium, and

3. HEALTH EFFECTS

with months of exposure to cadmium fume, but not cadmium sulfate aerosol. In an analysis of the smoking habits, there was no significant difference between the two cadmium-exposed groups with respect to the proportion of present or past cigarette smokers, the intensity or duration of cigarette smoking, or cigar or pipe smoking habits. The control subjects, however, had a significantly ($p < 0.05$) “higher” exposure to cigarette smoke than the cadmium exposed workers with substantially greater numbers of pack-years, cigarettes smoked per day, and years smoked. A step-down and multiple regression analyses with a dependent variable of FVC (as percent of predicted), and the independent variables, age-height, cigarette pack-years, and urinary cadmium, resulted in no indication that an interaction between the independent variables led to the observed relationship between FVC and cadmium excretion.

Other studies, however, have not shown a cadmium-related increase in impaired respiratory function. Edling et al. (1986) studied Swedish workers occupationally exposed to cadmium oxide fume from cadmium-containing solders. Cadmium-containing solder had been used at the plant from 1955 to 1978. The results from the lung-function analysis showed no significant difference in symptoms or lung function between the cadmium-exposed and the reference group. The exposed and the reference groups were similar with respect to sex, age, and height. There was a higher percentage of smokers in the reference group (52%) than in the exposed group (42%), but the difference was not statistically significant. The authors could not explain why significant differences in effects were not seen in these workers since other studies have shown significant effects at comparable cadmium exposure levels. The authors suggest that a possible bias could have been introduced if people who had worked for >5 years in the plant had changed their occupation because of lung disease, so that only “healthy” workers remained. Significant effects may also have been found if the reference group included workers other than those who worked with solder, but the purpose of the study was to resolve the effects of cadmium exposure among workers with similar occupations. Evaluating the data from smokers and nonsmokers separately also showed no significant impairment in lung function between smoking exposed and smoking unexposed or nonsmoking exposed and nonsmoking unexposed. The lung impairment due to smoking was observed in that smokers in both the exposed and unexposed groups had a somewhat deteriorated closing volume and other lung function indicators in accordance with previous studies on the effects of smoking. These results support the hypothesis that the response to occupational dust exposure differs from the response to tobacco smoking.

Another possible reason for differing results is that lung injury caused by high-level cadmium exposure may be partially reversible (Bonnell 1955; Chan et al. 1988), with a return towards normal several years

3. HEALTH EFFECTS

after exposures have been significantly reduced. Chan et al. (1988) studied a cohort of 36 female and 8 male workers at a Singapore cadmium battery factory exposed to cadmium oxide dust. Cadmium concentrations in air were 0.03–0.09 mg/m³ (geometric means). Lung function was measured using spirometry, helium dilution, tidal sampling, X-ray, and respiratory symptoms. The recovery of lung function after reduction or cessation of occupational exposure to cadmium dusts was assessed. Total lung capacity increased following reduction of exposure and, following cessation of exposure, vital capacity, FEV₁, and prevalence of respiratory symptoms all improved. Blood and urine cadmium concentrations were considerably lower with the reduction or cessation of exposure and were consistent with a decrease in the cadmium air levels.

Additional respiratory symptoms less frequently reported in workers occupationally exposed to cadmium are chronic rhinitis and impairment or loss of the sense of smell (Adams et al. 1969; Bonnell 1955; Friberg 1950; Liu et al. 1985; Rose et al. 1992). The cause of these effects may be chronic irritation or necrosis of the nasal membranes, as they are generally found only in individuals with high-level exposure. An increased prevalence of abnormal paranasal radiographic findings in cadmium-exposed workers compared to other published reports on non-exposed populations was reported by Shaham et al. (1993).

Studies in animals confirm that inhalation exposure to cadmium can lead to respiratory injury. Single acute exposures in rats to 5–10 mg Cd/m³ as cadmium oxide dust, cadmium oxide fume, or cadmium chloride for 1–5 hours resulted in moderate to severe, multifocal interstitial pneumonitis, diffuse alveolitis with hemorrhage, increased lung weight, inhibition of macrophages, focal interstitial thickening, edema, and necrosis of alveolar type 1 cells leading to type 2 cell hyperplasia and fibroblasts (Boudreau et al. 1989; Buckley and Bassett 1987b; Bus et al. 1978; Grose et al. 1987; Hart et al. 1989a; NTP 1995; Palmer et al. 1986). Similar results (i.e., severe pneumonitis) were seen in hamsters exposed to cadmium chloride at 10 mg/m³ for 30 minutes (Henderson et al. 1979) and in rabbits exposed to cadmium oxide dusts at 4.5 mg/m³ for 2 hours (Grose et al. 1987). Exposures in rats to cadmium chloride at 6.1 mg Cd/m³ 1 hour/day for 5, 10, or 15 days resulted in emphysema; a 3-day exposure to 61 mg Cd/m³ for 1 hour/day resulted in pulmonary hemorrhage (Snider et al. 1973). Repeated exposure to 0.088 mg Cd/m³ as cadmium oxide for 2 weeks resulted in minimal to mild alveolar histiocytic (macrophage) infiltration in rats and mice, focal inflammation surrounding alveolar ducts and extending into the adjacent alveolar septa in rats, and hyperplasia in tracheobronchial lymph nodes in mice (NTP 1995). At higher concentrations, the severity of these lesions increased (the severity of the lung lesions was scored as moderate at ≥ 0.88 mg Cd/m³) and necrosis of the epithelial lining of the alveolar ducts was observed at ≥ 0.26 mg Cd/m³ in rats and 0.88 mg Cd/m³ in mice. The NTP (1995) study also found significant

3. HEALTH EFFECTS

increases in the incidence of lesions in the nasal cavity; minimal-to-mild degeneration of the olfactory epithelium was observed in rats and mice exposed to 0.88 mg Cd/m³ and hyperplasia and inflammation of respiratory epithelium were observed in rats at 2.6 mg Cd/m³.

Persistent damage has been reported in an animal model following a single intratracheal exposure to 25, 100, or 400 µg cadmium chloride/kg body weight (Driscoll et al. 1992). Although most BALF biochemical (lactate dehydrogenase, total protein, and N-acetylglucosaminidase) and cellular (neutrophils and lymphocyte numbers) parameters returned to control levels 28 days after exposure, histopathological alterations including inflammation and fibrosis were still present 90 days post-exposure and the incidence and severity of the lesions were greater at 90 days compared to 28 days.

Intermediate-duration exposure to cadmium results in similar respiratory effects as seen in the acute exposures. Concentration-related increases in the severity and types of respiratory lesions have been observed. Because the intermediate-duration studies used different exposure protocols, intermittent exposure studies were duration-adjusted to continuous exposure (Table 3-2) to facilitate comparisons across these studies. The lowest adverse effect level for lung effects was 0.004 mg Cd/m³ for alveolar epithelial hyperplasia in mice (NTP 1995). At 0.008–0.07 mg Cd/m³, inflammation and minimal fibrosis were observed in rats, mice, and rabbits (Johansson et al. 1984; NTP 1995; Oberdörster et al. 1994) and marked inflammation and moderate fibrosis were observed in rats at 0.17 mg Cd/m³ (NTP 1995). At ≥0.34 mg Cd/m³, emphysema and chronic pneumonia were observed in rats and rabbits (Friberg 1950; Prigge 1978b). In addition to the widely reported effects in the lungs, NTP (1995) reported minimal lesions in the larynx of rats (epithelial degeneration) and mice (squamous metaplasia) exposed to 0.022 mg Cd/m³ and minimal lesions in the nasal cavity in rats (inflammation of respiratory epithelium) and mice (degeneration of olfactory epithelium) exposed to 0.088 mg Cd/m³. The toxicity of cadmium to the respiratory tract following intermediate-duration exposure is highlighted by the NTP (1995) rat and mouse studies. As summarized in Table 3-3, rats and mice were exposed to five concentrations (0.022, 0.044, 0.088, 0.22, and 0.88 mg Cd/m³ as cadmium oxide) 6.33 hours/day, 5 days/week for 13 weeks. The earliest effects observed were alveolar histiocytic infiltrates, alveolar epithelial hyperplasia, and tracheal epithelial hyperplasia or squamous metaplasia; these lesions were all graded as minimal. With increasing concentrations, the severity of most lesions increased as did the type of lesion.

There are fewer chronic-inhalation exposure studies that specifically reported systemic respiratory effects. Oldiges and Glaser (1986) report increased lung weights (amount unspecified) in rats from exposure to either cadmium sulfate at 0.092 mg Cd/m³ or cadmium sulfide at 0.254 mg Cd/m³ for 22 hours/day,

3. HEALTH EFFECTS

Table 3-2. Comparison of Lung Effects Across Intermediate-Duration Inhalation Studies

Species	Exposure frequency/duration	Adverse effect level (mg Cd/m ³)	Duration-adjusted adverse effect level (mg Cd/m ³)	Effect	Reference
Mouse	6.33 hours/day, 5 days/week, 13 weeks	0.022	0.004	Alveolar hyperplasia	NTP 1995
Rat	6.33 hours/day, 5 days/week, 13 weeks	0.044	0.008	Alveolar histiocytic infiltrates and hyperplasia	NTP 1995
Mouse	6.33 hours/day, 5 days/week, 13 weeks	0.044	0.008	Minimal fibrosis	NTP 1995
Mouse	6.33 hours/day, 5 days/week, 13 weeks	0.088	0.017	Moderate inflammation	NTP 1995
Rat	6.33 hours/day, 5 days/week, 13 weeks	0.22	0.017	Minimal fibrosis	NTP 1995
Mouse	6 hours/day, 5 days/week, 4 weeks	0.1	0.02	Inflammation	Oberdörster et al. 1994
Rat	24 hours/day, 7 days/week, 90 days	0.025	0.025	Proliferations	Prigge 1978a
Rat	6.33 hours/day, 5 days/week, 13 weeks	0.22	0.04	Inflammation	NTP 1995
Rat	6.33 hours/day, 5 days/week, 13 weeks	0.88	0.17	Marked inflammation and moderate fibrosis	NTP 1995
Mouse	6.33 hours/day, 5 days/week, 13 weeks	0.88	0.17	Moderate fibrosis	NTP 1995
Rat	6 hours/day, 5 days/week, 62 days	0.33	0.06	Fibrosis	Kutzman et al. 1986
Rabbit	6 hours/day, 5 days/week 4–6 weeks	0.4	0.07	Inflammation	Johansson et al. 1984
Rabbit	3 hours/day, 21 days/month, 9 months	4	0.34	Pneumonia/emphysema	Friberg 1950
Rabbit	3 hours/day, 23 days/month, 7 months	5.6	0.53	Emphysema	Friberg 1950
Rat	24 hours/day, 7 days/week				Prigge 1978b

3. HEALTH EFFECTS

Table 3-3. Severity of Respiratory Effects in Rats and Mice Exposed to Cadmium Oxide for 13 Weeks^a

	Concentration (mg Cd/m ³)					
	0	0.022	0.044	0.088	0.22	0.88
Male rats						
Lung						
Alveolar histiocytic infiltrate	—	— ^b	1.0 ^c	2.0	3.0	3.0
Alveolar epithelial hyperplasia	—	—	1.0	1.0	2.0	2.1
Inflammation	—	—	—	—	2.6	4.0
Fibrosis	—	—	—	1.0	2.0	2.7
Mediastinal lymph node						
inflammation	—	—	—	1.3	3.2	3.3
Larynx						
Epithelial degeneration	—	1.0	1.0	1.0	1.0	1.0
Nose						
Olfactory epithelium degeneration	—	—	—	—	1.0	3.0
Olfactory epithelium respiratory metaplasia	—	—	—	—	—	1.3
Olfactory epithelium squamous metaplasia	—	—	—	—	—	1.9
Respiratory epithelium inflammation	—	—	—	—	1.0	2.6
Respiratory epithelium degeneration	—	—	—	—	—	1.5
Female rats						
Lung						
Alveolar histiocytic infiltrate	—	—	1.0	2.1	3.0	3.0
Alveolar epithelial hyperplasia	—	—	1.0	1.0	2.0	2.1
Inflammation	—	—	—	—	1.6	3.5
Fibrosis	—	—	—	1.0	2.0	2.1
Mediastinal lymph node						
inflammation	—	—	1.0	1.5	3.6	4.0
Larynx						
Epithelial degeneration	—	1.0	1.0	1.0	1.0	1.0
Nose						
Olfactory epithelium degeneration	—	—	—	—	1.0	2.8
Olfactory epithelium respiratory metaplasia	—	—	—	—	1.0	1.0
Olfactory epithelium squamous metaplasia	—	—	—	—	—	1.4
Respiratory epithelium inflammation	—	—	—	1.0	1.8	1.8

3. HEALTH EFFECTS

Table 3-3. Severity of Respiratory Effects in Rats and Mice Exposed to Cadmium Oxide for 13 Weeks^a

	Concentration (mg Cd/m ³)					
	0	0.022	0.044	0.088	0.22	0.88
Male mice						
Lung						
Alveolar epithelial hyperplasia	—	1.0	1.0	1.8	1.7	2.0
Inflammation	—	—	—	3.0	2.2	2.7
Fibrosis	—	—	1.0	1.0	1.0	1.0
Tracheobronchial lymph node						
hyperplasia	—	—	1.0	2.3	2.4	2.7
Larynx						
Squamous metaplasia	—	1.0	1.0	1.0	1.0	1.1
Nose						
Olfactory epithelium degeneration	—	—	—	1.0	1.7	2.0
Olfactory epithelium respiratory metaplasia	—	—	—	—	1.0	1.5
Olfactory epithelium squamous metaplasia	—	—	—	—	—	1.0
Respiratory epithelium hyaline droplets	—	—	—	—	1.0	1.0
Female mice						
Lung						
Alveolar histiocytic infiltrate	—	1.0	1.0	2.0	2.0	3.0
Alveolar epithelial hyperplasia	—	—	—	1.4	2.0	2.0
Inflammation	—	—	—	2.3	2.1	2.9
Fibrosis	—	—	1.0	1.0	1.0	1.0
Tracheobronchial lymph node						
hyperplasia	—	—	1.0	1.5	2.0	2.4
Larynx						
Squamous metaplasia	—	1.0	1.0	1.0	1.0	1.0
Nose						
Olfactory epithelium degeneration	—	—	—	1.0	1.0	2.0
Olfactory epithelium respiratory metaplasia	—	—	—	—	—	1.0
Respiratory epithelium hyaline droplets	—	—	—	—	1.0	1.0

^aAnimals were exposed for 6.33 hours/day, 5 days/week.

^bNo lesions present or not significantly different from control group.

^cSeverity score: 1 = minimal, 2 = mild, 3 = moderate, 4 = marked

Source: NTP 1995

3. HEALTH EFFECTS

7 days/week for 413–455 days. Takenaka et al. (1983) observed adenomatous hyperplasia in the bronchoalveolar region in rats from exposure to cadmium chloride at 0.0134 mg Cd/m³ for 23 hours/day, 7 days/week for 18 months.

The available data suggest that there may be species differences in the respiratory toxicity of cadmium. In a comparison of the pulmonary response to exposure to 0.1 mg Cd/m³ as cadmium chloride 6 hours/day, 5 days/week for 4 weeks, Oberdörster et al. (1994) found that the inflammatory response in the lungs of mice was greater than that of rats exposed to the same cadmium concentration. However, the cadmium lung burden in mice was twice as high as the rat's lung burden. In the NTP (1995) study, adverse lung effects were observed at lower concentrations in mice compared to rats, but at the higher concentrations, the severity of the lung effects were greater in the rats. Although these data suggest species differences in the pulmonary toxicity of cadmium, more information is needed to evaluate if there are differences at given lung burdens.

Based on differences in the pharmacokinetic properties of various cadmium compounds, it is expected that differences in toxicity would be observed. As discussed in Oberdörster (1992), cadmium chloride and cadmium oxide elicited similar responses following a single intratracheal dose, whereas no response was observed for cadmium sulfide. However, Glaser et al. (1990) found similar responses following repeated exposures to various cadmium compounds.

Hart and colleagues (Hart 1986; Hart et al. 1989a, 2001) demonstrated that repeated low-concentration exposure to cadmium results in the development of adaptive survival response. In rats exposed to 1.6 mg Cd/m³ as cadmium acetate 3 hours/day, 5 days/week, thickening of the alveolar septa and mononuclear cell and polymorphonuclear leukocyte aggregates were observed after 2 weeks of exposure (Hart 1986). However, the inflammatory response was decreased after 3 weeks of exposure and no significant histopathological alteration were observed in rats exposed for 4, 5, or 6 weeks. After 5 weeks of cadmium exposure, a single high concentration (8.4 mg Cd/m³) resulted in less pulmonary damage compared to non-pretreated animals (Hart et al. 1989a). Multiple pulmonary resistance factors appear to contribute to this resistance/tolerance. These factors include increased levels of metallothionein, glutathione, and γ -glutamylcysteine synthetase (Hart et al. 2001). However, as suggested by Hart et al. (2001), cadmium-adapted alveolar epithelial cells have a reduced ability to repair DNA damage and apoptotic cell death is attenuated in these cells; thus, cadmium adapted animals may be more susceptible to tumor formation.

3. HEALTH EFFECTS

Cardiovascular Effects. Inhalation exposure to cadmium does not appear to have significant effects on the cardiovascular system. Most studies of workers occupationally exposed to cadmium have not found cadmium-related cardiovascular toxicity. In some studies, the mortality from cardiovascular disease was lower in the cadmium-exposed population. Armstrong and Kazantzis (1983) reported that a cohort of 6,995 British men occupationally exposed to cadmium for an average duration of 11 years had a significantly lower mortality from vascular disease.

Fifty-three male workers exposed to cadmium and lead and 52 male controls were examined for correlations in urine levels and blood pressure. The average duration of exposure was 12.5 years. Correlations between blood pressure and urinary cadmium in exposed workers were not significant after controlling for age or age and heart rate. Exposure to lead was a significant confounding factor (de Kort et al. 1987).

Friberg (1950) investigated the health of workers in a manufacturing plant that made cadmium-containing electrodes used in the production of batteries. Fifty-eight workers (30–50 years of age) were divided into two groups based on number of years at the plant. Workers were clinically examined for subjective symptoms and corresponding morphological or functional changes of the respiratory, cardiovascular, and excretory systems. The cardiovascular exam was largely unremarkable. Only a slight rise in blood pressure in a few cases was observed in Group 1. Electrocardiograms (EKG) were not significantly different from a matched control group in Group 1. Group 2 had neither increased blood pressure nor altered EKGs.

Kazantzis et al. (1988) studied mortality in a cohort of 6,958 cadmium-exposed male workers with average occupational exposures of 12 years. This was a follow-up study to the work of Armstrong and Kazantzis (1983). There was a significant deficit in deaths from cerebrovascular disease among men occupationally exposed to cadmium. There was no significant excess risk from hypertensive or renal disease.

Smith et al. (1980) studied 16 male high-exposure production workers and 11 male low-exposure office and supervisory workers for renal function. Average duration of exposure was 25 years. High-exposure workers were exposed to cadmium oxide concentrations of 0.23–45.2 mg/m³ and cadmium sulfide concentrations of 0.04–1.27 mg/m³. No difference was found in hypertension between high- and low-exposure workers, adjusted for age and weight or cigarette smoking.

3. HEALTH EFFECTS

Sorahan and Waterhouse (1983) examined mortality rates in a cohort of 3,025 nickel-cadmium battery workers (2,559 males and 466 females). Cadmium levels in air ranged from 0.05 to 2.8 mg/m³, primarily as cadmium oxide. Duration of exposure ranged from 1 to >6 years. No increase in mortality from diseases of the circulatory system (e.g., hypertension) was seen in cadmium-exposed workers.

Staessen and Lauwerys (1993), in a study known as the Cadmibel Study (a cross-sectional population study), evaluated 2,327 people from a random sample of the population of four Belgian districts chosen to provide a wide range of environmental exposure to cadmium. Participants completed a questionnaire regarding their medical history, current and past occupations, smoking habits, alcohol consumption, and intake of medications. Urine and blood samples were taken, and pulse rate, blood pressure, height, and weight were recorded. Exposure to cadmium was considered to be by both the oral and inhalation routes. Cadmium levels in blood and urine were significantly increased in the high-exposure areas compared to the low-exposure areas ($p < 0.001$). Blood pressure was not correlated with the urine or blood cadmium levels. The prevalence of hypertension or other cardiovascular diseases was similar in all four districts, and was not correlated with urine or blood cadmium levels. A follow-up investigation of 692 participants of this study also showed no correlation with urine or blood cadmium levels and the prevalence of hypertension after 5 years (Staessen et al. 2000). These results do not support a hypothesis that cadmium increases blood pressure, prevalence of hypertension, or other cardiovascular diseases.

One study found a statistically significant increase in blood pressure in exposed workers compared to controls (Thun et al. 1989), but mortality in this cohort was lower than expected (Thun et al. 1985).

There are limited data on the cardiotoxicity of cadmium in animals. No significant alterations in systolic blood pressure or histological alterations in the heart were observed in rats exposed to cadmium oxide concentrations as high as 0.88 mg Cd/m³ for 13 weeks (NTP 1995).

Gastrointestinal Effects. In the cohort he studied, Friberg (1950) found no association between inhalation cadmium exposure in workers and symptoms of gastrointestinal toxicity. Symptoms that had been reported in case histories from the 1920s included pain or tenderness at the epigastrium associated with nausea and some constipation. No other human studies report any cadmium associated gastrointestinal toxicity from inhalation exposure.

In the only animal study located, Rusch et al. (1986) observed erosion of the stomach in rats from exposure to cadmium carbonate at 132 mg Cd/m³ for 2 hours. Postmortem evaluation was performed at

3. HEALTH EFFECTS

1, 3, 7, and 30 days postexposure. After the inhalation exposure in a whole-body chamber, rats were vacuumed to remove any cadmium carbonate dust adhering to the ventral and dorsal fur. The 132 mg Cd/m³ dose is relatively high. Three of the 10 test animals died during the 2-hour exposure so the significance of the gastrointestinal effect in this study is unclear.

Hematological Effects. The evidence concerning hematological effects following inhalation exposure to cadmium is conflicting. Lowered hemoglobin concentrations and decreased packed cell volumes have been observed in some studies of workers occupationally exposed to cadmium (Bernard et al. 1979; Friberg 1950; Kagamimori et al. 1986), but not in others (Bonnell 1955; Chan et al. 1988; Davison et al. 1988). The changes that were found often were not statistically significant (Bernard et al. 1979; Friberg 1950), and examination of bone marrow of some workers with lowered hemoglobin revealed no detectable abnormalities (Friberg 1950).

Conflicting results on the hematologic effect of cadmium after inhalation exposure have also been obtained with animal studies. Rabbits exposed to cadmium oxide dust at 4 mg/m³ for 3 hours/day, 21 days/month for 9 months developed eosinophilia and a slightly lower hemoglobin (Friberg 1950). In contrast, rats exposed to cadmium oxide dust at 0.052 mg Cd/m³ for 24 hours/day for 90 days had increased hemoglobin and hematocrit that were attributed to decreased lung function (Prigge 1978a). Prigge (1978b) also reported increased hemoglobin and hematocrit in rats continuously exposed to cadmium chloride at 0.204 mg Cd/m³ and higher for 21 days. Other studies report no Cd-related hematological effects. A nearly continuous 30-day exposure in rats to cadmium sulfide at 1.034 mg Cd/m³ had no effect on red blood cell counts (Glaser et al. 1986). A nearly continuous 218-day exposure in rats to cadmium oxide dust or fume at 0.090 mg Cd/m³ had no effect on a routine hematological evaluation (specific tests not reported) (Oldiges and Glaser 1986). A partial explanation for these conflicting results may be that Cd-induced anemia primarily results from impaired absorption of iron from the diet following gastrointestinal exposure to cadmium (see Section 3.2.2.2), and the amount of gastrointestinal exposure following cadmium inhalation is variable depending on the form and dose.

Musculoskeletal Effects. Case studies indicate that calcium deficiency, osteoporosis, or osteomalacia can develop in some workers after long-term occupational exposure to high levels of cadmium (Adams et al. 1969; Blainey et al. 1980; Bonnell 1955; Kazantzis 1979; Scott et al. 1980). Effects on bone generally arise only after kidney damage has occurred and are likely to be secondary to resulting changes in calcium, phosphorus, and vitamin D metabolism (Blainey et al. 1980).

3. HEALTH EFFECTS

No studies were located regarding musculoskeletal effects in animals after inhalation exposure to cadmium.

Hepatic Effects. Liver effects are not usually associated with inhalation exposure to cadmium. Friberg (1950) reported some nonspecific signs of liver disease in some workers from a group exposed to cadmium in the air for 20 years. Test results included increased serum gamma-globulin, and other indicators of abnormal serum globulins, including the flocculation test results of a positive Takata reaction and/or an elevated thymol values. These tests (the latter of which are not used today) were nonspecific indicators of cirrhosis or hepatitis. The significance of these test results with respect to cadmium exposure is questionable. Subsequent studies on workers exposed to cadmium in the air have not reported adverse liver effects (Adams et al. 1969; Bonnell 1955).

Liver effects have occasionally been found in animal studies. Cats examined within one day of inhalation exposure to an unspecified concentration of cadmium oxide fume had a variety of hepatic lesions, and liver changes from cell granulation at low doses to fatty infiltration at high doses (Prodan 1932). Increased serum alanine aminotransferase activity, indicative of liver damage, was seen in rats exposed for 30 days to 0.1 mg/m³ cadmium, but activity had returned to normal 2 months after exposure (Glaser et al. 1986). Kutzman et al. (1986) reported an increased liver relative weight in rats from a cadmium chloride exposure at 1.06 mg Cd/m³ for 6 hours/day, 5 days/week, for 62 days. Increased liver weight was not observed from a continuous cadmium chloride exposure at 0.029 mg Cd/m³ for 255 days, from a continuous cadmium oxide exposure at 0.090 mg Cd/m³ for 218 days, or from a continuous cadmium sulfate exposure at 0.095 mg Cd/m³ for 413 days (Oldiges and Glaser 1986). Similar negative results were reported by Prigge (1978a, 1978b) for a 21-day exposure to cadmium chloride at 0.581 mg Cd/m³, and for a 63-day exposure to cadmium oxide at 0.105 mg Cd/m³ (a dose that was very toxic to the lungs). A continuous high-dose exposure to cadmium sulfide at 2.247 mg Cd/m³ for 105 days did result in an unspecified increase in liver weight in surviving rats (Oldiges and Glaser 1986). Cadmium accumulates in the liver as well as the kidney, the main target organ for cadmium toxicity. The resistance of the liver to toxic effects from cadmium may be related to a higher capacity of the liver to produce metallothionein that would bind to cadmium and would lower the concentrations of free cadmium ions (see Section 3.4.3).

Renal Effects. There is very strong evidence that the kidney is one of the main target organ of cadmium toxicity following extended inhalation exposure. The sensitivity of the kidney to cadmium was recognized in an early investigation of workers exposed to cadmium oxide dust and cadmium fumes in a factory producing nickel-cadmium batteries (Friberg 1950). These workers suffered from a high

3. HEALTH EFFECTS

incidence of abnormal renal function, indicated by proteinuria and a decrease in glomerular filtration rate. Many studies examining cadmium workers have reported various effects on the kidneys. Similar signs of renal damage have been observed in many other studies of workers occupationally exposed to cadmium (Adams et al. 1969; Bernard et al. 1979; Beton et al. 1966; Bonnell 1955; Bustueva et al. 1994; Chia et al. 1989; Elinder et al. 1985a, 1985b; Falck et al. 1983; Gompertz et al. 1983; Iwata et al. 1993; Jakubowski et al. 1987; Järup and Elinder 1993; Järup et al. 1988; Kjellström et al. 1977a; Liu et al. 1985; Mason et al. 1988; Piscator 1966; Roels et al. 1981b; Rose et al. 1992; Smith et al. 1980; Thun et al. 1989). Most of these studies did not report cadmium exposure levels; rather, urinary cadmium, blood cadmium, or cumulative exposures were used as biomarkers of exposure. Thus, these studies are not presented in the LSE table (Table 3-1). Selected occupational exposure studies are summarized in Table 3-4.

One of the first signs of kidney effects is tubular dysfunction characterized by an increased urinary excretion of low-molecular-weight proteins such as β 2-microglobulin, human complex-forming glycoprotein (pHC) (also referred to as α 1-microglobulin), and retinol binding protein or increased urinary levels of intracellular enzymes such as N-acetyl- β -glucosaminidase (NAG) (European Chemicals Bureau 2007; Järup et al. 1998b). Numerous occupational exposure studies have reported increases in urinary levels of these biomarkers (Bernard et al. 1990; Chen et al. 2006a, 2006b; Chia et al. 1992; Elinder et al. 1985b; Falck et al. 1983; Jakubowski et al. 1987, 1992; Järup and Elinder 1994; Järup et al. 1988; Kawada et al. 1989; Roels et al. 1993; Shaikh et al. 1987; Thun et al. 1989; Toffoletto et al. 1992; Verschoor et al. 1987). At higher exposure levels, increased urinary levels of high-molecular-weight proteins such as albumin have been reported (Bernard et al. 1979, 1990; Chen et al. 2006a, 2006b; Elinder et al. 1985b; Mason et al. 1988; Roels et al. 1989, 1993; Thun et al. 1989), but there is some debate as to whether this represents glomerular damage (Bernard et al. 1979; Roels et al. 1989) or severe tubular damage (Elinder et al. 1985a; Mason et al. 1988; Piscator 1984).

Chronic exposure to very high cadmium levels can result in glomerular damage resulting in decreases in glomerular filtration rate (GFR) (Friberg 1950; Järup et al. 1995b; Roels et al. 1991). Järup et al. (1995b) found a dose-response relationship between blood cadmium levels and GFR in cadmium workers. At blood cadmium levels of 5.6 to $<8.4 \mu\text{g/L}$, 33.3% of the workers had decreased GFR (defined as $<80\%$ of referents); whereas all subjects with blood cadmium levels of $\geq 8.4 \mu\text{g/L}$ exhibited a decreased GFR.

Another study did not find alterations in GFR in workers with urinary cadmium levels of approximately $11 \mu\text{g/g}$ creatinine; however, an exacerbation of the age-related decline in maximal GFR was observed

3. HEALTH EFFECTS

Table 3-4. Summary of Occupational Exposure Studies Examining Renal Effects

Population	Effect	Adverse effect level	Reference
Zinc-cadmium smelter workers (n=87)	Age-related decline in maximal GFR was exacerbated in workers with cadmium-induced microproteinuria.	U-Cd: 11.1 µg/g creatinine	Roels et al. 1991
Workers using cadmium pigments in plastic production or using cadmium in welding (n=27)	Significant increase in urinary β2M and NAG levels.	U-Cd: 5 µg/g creatinine	Verschoor et al. 1987
Cadmium alloy workers (n=164)	Higher incidence of increased urinary β2M levels (>250 µg/L cut-off) when urinary cadmium levels exceeded 10 µg/g creatinine on one or more occasions, as compared to workers who never exceeded the 10 µg/g creatinine level.	U-Cd: 10 µg/g creatinine	Toffoletto et al. 1992
Cadmium smelter workers (n=53)	Significant increase in urinary protein and β2M levels.	U-Cd: 13.3 µg/g creatinine	Shaikh et al. 1987
Non-ferrous smelter workers (n=58)	Significant increase in urinary β2M, RBP protein, pHc, albumin, and transferrin levels.	U-Cd: >10 µg/g creatinine	Bernard et al. 1990
Workers exposed to cadmium pigment dust (n=58)	Significant correlation between urinary cadmium and NAG levels; significant correlation with β2M at one of the two time points.	U-Cd: 1.1–1.4 µg/g creatinine	Kawada et al. 1989
Zinc-cadmium smelter workers (n=50)	Significant association between urinary cadmium levels and urinary levels of NAG, albumin, and transferrin. At higher urinary cadmium levels (10 µg/g creatinine), there were significant associations with RBP and β2M.	U-Cd: 4 µg/g creatinine	Roels et al. 1993
Battery workers (n=561)	10% prevalence of abnormal β2M levels (220 µg/g creatinine cut-off).	U-Cd: 1.5 µg/g creatinine for ≥60 years of age U-Cd: 5 µg/g creatinine for <60 years of age	Järup and Elinder 1994
Alkaline battery factory workers (n=102)	10% prevalence of renal dysfunction (β2M >380 µg/g creatinine; RBP >130 µg/g creatinine).	U-Cd: 10–15 µg/g creatinine	Jakubowski et al. 1987
Workers at a factory using cadmium-containing solders (n=60)	25% prevalence of abnormal β2M levels (300 µg/g creatinine cut-off).	U-Cd: 2–5 µg/g creatinine	Elinder et al. 1985a

3. HEALTH EFFECTS

Table 3-4. Summary of Occupational Exposure Studies Examining Renal Effects

Population	Effect	Adverse effect level	Reference
Workers at nickel-cadmium battery factory (n=92)	Significant increase in pHC and NAG levels (after adjustment for age, gender, and race).	U-Cd: 5–10 µg/g creatinine	Chia et al. 1992
Cadmium smelter workers (n=85)	Significant increases in levels β2M and NAG levels and increased prevalence of abnormal levels of these biomarkers.	U-Cd: 5–10 µg/g creatinine	Chen et al. 2006a, 2006b
Alkaline battery factory workers (n=141)	10% prevalence of renal dysfunction (β2M >300 µg/L; RBP >300 µg/L).	B-Cd: 300 µg-years/L (30 years of 10 µg/L)	Jakubowski et al. 1992
Battery workers (n=440)	Approximately 10% prevalence of abnormal β2M levels (35 µg/mmol creatinine cut-off).	B-Cd: 5.6 µg/L Cumulative exposure: 691 µg-years/m ³	Järup et al. 1988
Cadmium recovery plant workers (n=45)	Significant association between cumulative exposure and urinary β2M, RBP, phosphate, and calcium and serum creatinine levels.	Cumulative exposure: 300 mg/m ³	Thun et al. 1989
Workers exposed to cadmium fumes (n=33)	Increased urinary β2M and protein levels (mean 6,375 µg/g creatinine and 246 mg/g creatinine, respectively) in 7 workers (mean in remaining 23 workers 53 µg/g creatinine and 34 mg/g creatinine).	Cumulative exposure: 1,137 µg/m ³ /years	Falck et al. 1983

U-Cd = urinary cadmium, B-Cd = blood cadmium; GFR = glomerular filtration rate; pHC = human complex-forming glycoprotein (also referred to as α1-microglobulin); NAG = N-acetyl-β-glucosaminidase; β2M = β2-microglobulin; prt = protein; RBP = retinol binding protein

3. HEALTH EFFECTS

(Roels et al. 1991). Other studies reported increases in serum creatinine levels, which are suggestive of impaired GFR (Roels et al. 1989; Thun et al. 1989).

Depressed tubular resorption of other solutes such as enzymes, amino acids, glucose, calcium, copper, and inorganic phosphate have been reported in workers with signs of tubular proteinuria (Elinder et al. 1985a, 1985b; Falck et al. 1983; Gompertz et al. 1983; Mason et al. 1988). An increased frequency of kidney stone formation has also been reported in cadmium workers (Elinder et al. 1985a; Falck et al. 1983; Järup and Elinder 1993; Kazantzis 1979; Scott et al. 1978; Thun et al. 1989; Trevisan and Gardin 2005). This effect is likely to be secondary to disruption of calcium metabolism due to kidney damage. Järup and Elinder (1993) calculated an incidence rate ratio (IRR) (after adjustment for age and calendar time) of 3.0 (95% CI 1.3–6.8) for the occurrence of kidney stones among workers with a cumulative exposure of $\geq 5000 \mu\text{g}/\text{m}^3$ years; the IRR was not significantly elevated at lower cumulative exposure levels. Significant increases in kidney stone formation were observed in workers with increased urinary cadmium (median of 3.7 $\mu\text{g}/\text{g}$ creatinine), blood cadmium (median of 7 $\mu\text{g}/\text{L}$), and urinary β_2 -microglobulin (median of 155 $\mu\text{g}/\text{g}$ creatinine). The increased kidney stone formation may be secondary to the cadmium-induced kidney damage disruption of calcium metabolism.

Hellström et al. (2001) evaluated the association between occupational cadmium exposure and end stage renal disease among cadmium workers and residents living near a cadmium facility; renal replacement therapy was used as a surrogate for renal disease. The standardized rate ratios (SRRs) (95% CI) were 2.1 (0.6–5.3) and 2.5 (0.7–6.5) in male workers aged 20–79 or 40–79 years, respectively. Although the SRRs were not statistically significant, the ratios were significantly elevated in residents presumably exposed to lower cadmium levels (see Section 3.2.2.2 for more information on these results). Studies examining the cause of death among cadmium workers have not found significant increases in the standardized mortality ratios (SMRs) for nephritis or nephrosis (Armstrong and Kazantzis 1983; Järup et al. 1998a) or nonmalignant renal disease (Thun et al. 1985).

The data from studies of cadmium workers provide strong, clear evidence that the kidney is a sensitive target following chronic exposure, but the data do not clearly identify a threshold of toxicity. The earliest indication of an effect on the kidney is an increase in urinary levels of low molecular weight proteins particularly β_2 -microglobulin, retinol binding protein, and pHc. However, there is some question as to the adversity of these early indicators because increased excretion of low molecular weight proteins precede the clinical manifestations (Bernard et al. 1997; Järup et al. 1998b). As noted by Bernard et al. (1997), the assessment of the health significance of changes affecting a biomarker involves localizing the

3. HEALTH EFFECTS

changes in the sequence of events that ultimately results in compromised renal function and appreciating the probability that these changes may lead to a deterioration of renal function. Their guidelines for interpreting β 2-microglobulin levels in cadmium workers are presented in [Table 3-5](#).

Another aspect of interpreting alterations in renal biomarkers and assessing risk is the issue of the reversibility of cadmium-induced tubular dysfunction and impaired glomerular filtration rate. In workers exposed to high levels of cadmium, cessation of exposure does not generally result in a reversibility of kidney damage. Increases in urinary levels of β 2-microglobulin, retinol binding protein, or total protein (Elinder et al. 1985b; Järup et al. 1993; Mason et al. 1999; Piscator 1984; Roels et al. 1989; Thun et al. 1989) or a decrease in glomerular filtration rate (Järup et al. 1993; Piscator 1984; Roels et al. 1989) have been observed in workers years after cadmium exposure cessation. However, in workers exposed to low levels of cadmium, cessation of exposure resulted in decreased or no change in urinary β 2-microglobulin levels (McDiarmid et al. 1997; van Sittert et al. 1993). In studies by Roels et al. (1997) and Trzcinka-Ochocka et al. (2002), former cadmium workers were divided into groups based on historical cadmium levels and urinary β 2-microglobulin or retinol binding protein levels. Both studies found that the reversibility of tubular dysfunction was dependent on the cadmium body burden and the severity of microproteinuria at the time cadmium exposure was reduced or ceased. In the Roels study, significant decreases in retinol binding protein levels and no change in β 2-microglobulin levels were observed in workers whose urinary cadmium levels never exceeded 10 μ g/g creatinine. Decreases in β 2-microglobulin and retinol binding protein levels were also observed in workers whose β 2-microglobulin levels were <300 μ g/g creatinine or between 300 and 1,500 μ g/g creatinine and urinary cadmium levels were >10 μ g/g creatinine, but were never >20 μ g/g creatinine. However, a progression of microproteinuria (increased urinary levels of β 2-microglobulin and retinol binding protein levels) was observed in workers who had initial β 2-microglobulin levels >1,500 μ g/g creatinine and urinary cadmium levels >20 μ g/g creatinine. In contrast, Trzcinka-Ochocka et al. (2002) found decreases in β 2-microglobulin and retinol binding protein levels in groups of workers with initial β 2-microglobulin and retinol binding protein levels of \leq 300, >300, \leq 1,500, or \geq 1,500 μ g/g creatinine; in all groups, the initial mean urinary cadmium levels were >20 μ g/g creatinine. However, the risk of increased excretion of retinol binding protein was higher in the groups of workers with initial retinol binding protein levels of >300 μ g/g creatinine. Logistic regression analysis demonstrated that the initial level of retinol binding protein was the most important determinant in reversibility of tubular proteinuria and that the influence of urinary cadmium level or length of time since exposure cessation was not statistically significant.

3. HEALTH EFFECTS

Table 3-5. Guidelines for Interpreting β 2-microglobulin Levels

β 2-Microglobulin level	Significance
<300 μ g/g creatinine	Normal value.
300–1,000 μ g/g creatinine	Incipient cadmium tubulopathy (possibility of reversibility after removal from exposure). No change in GFR.
1,000–10,000 μ g/g creatinine	Irreversible tubular proteinuria which may lead to accelerated decline in the GFR with age. GFR normal or slightly altered.
>10,000 μ g/g creatinine	Overt cadmium nephropathy usually associated with decreased GFR.

GFR = glomerular filtration rate

Source: Bernard et al. 1997

3. HEALTH EFFECTS

The available occupational exposure data suggest that tubular dysfunction generally develops only after cadmium reaches a threshold concentration in the renal cortex. However, a number of factors can influence urinary levels of β 2-microglobulin or retinol binding protein and direct relationship between urinary levels of these proteins and a kidney cadmium concentration has not been established. Based on the findings of early occupational exposure studies, a number of investigators estimated that the “critical concentration” of cadmium in the renal cortex associated with increased incidence of renal dysfunction in an occupational setting was about 200 $\mu\text{g/g}$ wet weight (Friberg et al. 1974; Kjellström et al. 1977a; Roels et al. 1983); this corresponds to a urinary cadmium levels of 5–10 $\mu\text{g/g}$ creatinine (European Chemicals Bureau 2007). Although 10 $\mu\text{g/g}$ creatinine was initially established as a threshold urinary cadmium concentration, there is sufficient evidence to suggest that adverse effects occur at lower urinary cadmium levels (Chen et al. 2006a, 2006b; Chia et al. 1992; Elinder et al. 1985b; Järup and Elinder 1994; Kawada et al. 1989; Roels et al. 1993; Verschoor et al. 1987).

Indications of renal dysfunction associated with airborne cadmium exposure has also been observed in residents living near a lead/zinc smelter in the United Kingdom with high cadmium stack emissions (Thomas et al. 2009) and a zinc smelter in Norway (Bråtveit et al. 2011). In both studies, the subjects were exposed to airborne cadmium and elevated cadmium levels in the soil. The Thomas et al. (2009) study found a significant association between urinary cadmium levels and modeled atmospheric cadmium concentrations. The mean urinary cadmium concentrations were 0.22 and 0.34 nmol/mmol creatinine (approximately 0.22 and 0.34 $\mu\text{g/g}$ creatinine) in males and females, respectively, in the Thomas et al. (2009) study and 0.44 and 0.42 $\mu\text{g/g}$ creatinine in males and females, respectively, in the Bråtveit et al. (2011) study; Bråtveit et al. (2011) also measured urinary cadmium levels in the residents living in a nonpolluted area and found no significant differences in urinary cadmium levels between the two groups. Thomas et al. (2009) found significant correlations between urinary cadmium levels and urinary NAG levels in males and females and pHC in females. Additionally, the study found a significant dose-response relationship between urinary cadmium levels and NAG levels above the reference level of 1.25 IU/mmol creatinine. Bråtveit et al. (2011) also found a significant association between urinary pHC levels and urinary cadmium levels; however, there were no significant differences in pHC levels between residents living in the polluted areas and the control area.

Early animal studies confirmed that renal damage occurs following inhalation exposure to cadmium. Rabbits developed proteinuria after a 4-month inhalation exposure to cadmium metal dust at 4 mg/m^3 for 3 hours/day, 21 days/month; histologic lesions were found after an additional 3–4 months of exposure (Friberg 1950). Friberg (1950) noted that the degree of proteinuria was not especially pronounced. Most

3. HEALTH EFFECTS

subsequent studies using inhalation exposure have not found proteinuria (Glaser et al. 1986; Kutzman et al. 1986; Prigge 1978a, 1978b), primarily because the levels of exposure and durations of follow up (e.g., 1–5 mg/m³ for intermediate exposures; 0.2–2 mg/m³ for chronic exposures) that produce serious respiratory effects have not been sufficient to produce a critical concentration of cadmium in the kidney.

Dermal Effects. Dermal toxicity does not appear to be a significant effect of inhalation exposure to cadmium. Studies of workers occupationally exposed to cadmium have not reported dermal effects following acute or chronic exposure (Barnhart and Rosenstock 1984; Bonnell 1955; Friberg 1950). No study was located that specifically examined dermal toxicity in humans or animals following inhalation exposure to cadmium.

Ocular Effects. Ocular toxicity does not appear to be a significant effect of inhalation exposure to cadmium. Studies of workers occupationally exposed to cadmium have not reported ocular effects following acute or chronic exposure (Barnhart and Rosenstock 1984; Bonnell 1955; Friberg 1950). No study was located that specifically examined ocular toxicity in humans following inhalation exposure to cadmium.

Rats exposed to a single 2-hour inhalation exposure to about 100 mg Cd/m³ as cadmium pigments had excessive lacrimation 4 hours after exposure (Rusch et al. 1986), but this was likely due to a direct irritation of the eyes rather than a systemic effect.

Body Weight Effects. No data were found regarding the effects of inhaled cadmium on human body weights.

In animals, cadmium has been shown to significantly reduce body weights. An acute exposure to cadmium oxide fumes at 112 mg Cd/m³ for 2 hours (Rusch et al. 1986) and cadmium oxide dust at 4.6 mg Cd/m³ for 3 hours (Buckley and Bassett 1987b) resulted in a significant reduction of body weight in male rats. Cadmium chloride at 6.5 mg Cd/m³ for 1 hour or 4.5 mg Cd/m³ for 2 hours produced significant reductions in male rat body weights (Bus et al. 1978; Grose et al. 1987). Cadmium carbonate at 132 mg Cd/m³ for 2 hours slowed rat body weight gains (Rusch et al. 1986). NOAELs for acute cadmium chloride exposure have been reported at 0.45 mg Cd/m³ for 2 hours (Grose et al. 1987); 0.17 mg Cd/m³ for 6 hours/day for 10 days (Klimisch 1993); and 6 mg Cd/m³ for 2 hours (Palmer et al. 1986). NOAELs for cadmium sulfide and cadmium selenium sulfide were much higher at 99 mg Cd/m³ for 2 hours and 97 mg Cd/m³ for 2 hours, respectively (Rusch et al. 1986). The effect of cadmium on body weight gain

3. HEALTH EFFECTS

appears to compound-related, with cadmium chloride the most toxic and cadmium sulfide the least toxic. These compound-related differences are probably related to difference in absorption.

The body weight response also appears to be duration-related; lower NOAELs and LOAELs have been identified for intermediate-duration exposure. Levels of cadmium that significantly reduce rat body weights when administered for an intermediate exposure duration have been reported for cadmium chloride at around 1 mg Cd/m³ for female and male rats (Baranski and Sitarek 1987; Kutzman et al. 1986), for cadmium chloride at around 0.394 mg Cd/m³ for pregnant female rats (Prigge 1978a), and for cadmium dusts at 0.1 mg Cd/m³ for female rats (Prigge 1978a). NOAELs have been reported for intermediate exposures to cadmium chloride at 0.394 mg Cd/m³ for female nonpregnant rats (Prigge 1978a), 0.33 mg Cd/m³ for rats (Kutzman et al. 1986), and 0.0508 mg Cd/m³ for male rats (Takenaka et al. 1983). NOAELs have been reported for intermediate exposures to cadmium oxide dust at 0.16 mg Cd/m³ for female rats (Baranski and Sitarek 1987) and 0.45 mg Cd/m³ for male rabbits (Grose et al. 1987); and for cadmium sulfide at 1.034 mg Cd/m³ for male rats (Glaser et al. 1986). A NOAEL for chronic exposure in rats to cadmium sulfate has been reported as 0.95 mg Cd/m³ (Oldiges and Glaser 1986).

Other Systemic Effects. Yellow discoloration of the teeth has occasionally been reported in workers occupationally exposed to high levels of cadmium (Friberg 1950; Liu et al. 1985). No data were located to indicate that this was related to any functional impairment.

3.2.1.3 Immunological and Lymphoreticular Effects

There is limited evidence for immunological effects following inhalation exposure to cadmium. The blood of workers exposed to cadmium for 1–14 years had a slight but statistically significant decrease in the generation of reactive oxygen species by leukocytes compared to unexposed controls (Guillard and Lauwerys 1989). The toxicological significance of this effect is unclear.

Karakaya et al. (1994) measured blood and urine concentrations of cadmium, and serum IgG, IgM, and IgA in a group of 37 males employed in zinc/cadmium smelters and a small Cd-electroplating plant. Blood cadmium concentrations were significantly higher in exposed workers compared to controls in both the urine (2.39 versus 0.69 µg/100 mL, p<0.001) and the blood (5.55 versus 2.01 µg/g creatinine, p<0.05). No differences between the exposed and control serum concentrations of IgG, IgM, and IgA populations were observed. No changes in blood counts of white blood cells (lymphocyte, neutrophil, and eosinophil)

3. HEALTH EFFECTS

were found between exposed and control populations, except for significantly increased monocyte counts. No other studies were located regarding immunological effects in humans following inhalation exposure to cadmium.

Acute inhalation exposure to cadmium chloride in mice at 0.190 mg Cd/m³ for 2 hours can affect immune function, causing suppression of the primary humoral immune response (Graham et al. 1978). The NOAEL for immunological effects from the study by Graham et al. (1978) was 0.11 mg Cd/m³. Krzystyniak et al. (1987) reported spleen lymphocyte cytotoxicity at 0.88 mg Cd/m³ for 1 hour.

At intermediate-duration exposures, Kutzman et al. (1986) observed increased spleen relative weights and lymphoid hyperplasia from inhalation of cadmium chloride aerosols at 1.06 mg Cd/m³ 6 hours/day, 5 days/week for 62 days. Prigge (1978b) also observed increased relative spleen weights in pregnant females at 0.394 mg Cd/m³ for an exposure of 24 hours/day for 21 days during gestation. Oldiges and Glaser (1986) observed enlarged thoracic lymph nodes in dead animals in a chronic-exposure study with cadmium sulfate at 0.092 mg Cd/m³ for 22 hours/day, 7 days/week for 413–455 days; and in an intermediate study with cadmium oxide dust at 0.090 mg Cd/m³ for 22 hours/day, 7 days/week for 218 days. However, other studies have found no effect on natural killer cell activity or viral induction of interferon in mice (Daniels et al. 1987). Evidence concerning the effect of inhalation exposure to cadmium on resistance to infection is conflicting, because the same exposure decreases resistance to bacterial infection while increasing resistance to viral infection (Bouley et al. 1982). The highest NOAEL values and all LOAEL values from each reliable study for immunological effects in each species and duration category are recorded in [Table 3-1](#) and plotted in [Figure 3-1](#).

3.2.1.4 Neurological Effects

Neurotoxicity is not generally associated with inhalation exposure to cadmium, although a few studies have specifically looked for neurological effects. Hart et al. (1989b) reported that in a group of 31 men occupationally exposed to cadmium in a refrigerator coil manufacturing plant (average exposure=14.5 years) there was a modest correlation between cadmium exposure and decreased performance on neuropsychologic tests for attention, psychomotor speed, and memory. The limited number of men studied makes it difficult to evaluate the significance of this effect.

Rose et al. (1992) studied the presence and severity of olfactory impairment in workers chronically exposed to cadmium fumes generated during a brazing operation. Detailed occupational history, medical

3. HEALTH EFFECTS

history, and smoking history, and symptoms were collected for 55 workers. Body burden was estimated using urinary cadmium levels, and renal damage was assessed by urinary β_2 -microglobulin levels. Olfactory test scores from these workers were compared to a reference group of 16 male subjects that were selected according to the following criteria: (1) no history of taste or smell complaints, (2) no history of surgery to the upper respiratory tract, (3) no upper respiratory tract infection within 2 days of testing, and (4) no history of having been tested. The dose of the cadmium oxide fume received by the workers being evaluated in this study was not reported or estimated. For both the exposed workers and the reference group, 38% were smokers. A significant olfactory impairment was observed in the workers compared to the reference group ($p < 0.003$). Thirteen percent of the workers were either moderately or severely hyposmic compared to none in the reference group, 44% of the workers were mildly hyposmic compared to 31% of the reference group, and only 44% of workers were normosmic. Although the odor-identification test findings for workers were similar to those of the reference group, butanol detection threshold scores were significantly lower in the worker population ($p < 0.005$). The workers with both higher urinary cadmium levels and tubular proteinuria had the most significant olfactory dysfunction, with a selective defect in odor threshold. The results suggest that chronic occupational cadmium exposure sufficient to cause renal damage is also associated with impairment in olfactory function. Some limitations of the study are that historical exposure to other confounders cannot be ruled out, the classification for nephrotoxicity is based on a single 24-hour urine β_2 -microglobulin level, and the smoking history of the reference group was unknown. No other human neurological studies from inhaled cadmium were found.

In rats, cadmium carbonate produced tremors from exposure to 132 mg Cd/m^3 for 2 hours, and cadmium fumes produced reduced activity at 112 mg Cd/m^3 for 2 hours (Rusch et al. 1986). Studies on continuous exposure to cadmium for 30 days have shown no neurological effects at 0.105 mg Cd/m^3 for cadmium chloride, 0.098 mg Cd/m^3 for cadmium dusts, or 1.034 mg Cd/m^3 for cadmium sulfide (Glaser et al. 1986). Cadmium chloride had no neurological effects at 0.33 mg Cd/m^3 for 5 days/week, 6 hours/day for a total of 62 daily exposures, but did significantly increase relative brain weight at 1.034 mg Cd/m^3 (Kutzman et al. 1986). No other studies were located regarding neurological effects in adult animals after inhalation exposure to cadmium. Neurological effects in offspring of rats exposed to cadmium by inhalation during gestation are discussed in Section 3.2.1.5. The highest NOAEL values and all LOAEL values from each reliable study for neurological effects in each species and duration category are recorded in [Table 3-1](#) and plotted in [Figure 3-1](#).

3. HEALTH EFFECTS

3.2.1.5 Reproductive Effects

Evidence is insufficient to determine an association between inhalation exposure to cadmium and reproductive effects.

Gennart et al. (1992) studied male reproductive effects of cadmium in 83 occupationally exposed blue-collar Belgian workers in two smelting operations. The workers were exposed to cadmium in dust and fumes. Information was recorded on age, residence, education, occupational and health history, actual and previous occupations, smoking habits, and coffee and alcohol consumption. Fertility parameters included dates of birth of wife and husband, date of marriage, and number of children born alive and their dates of birth. Blood and urine samples were also collected from each worker. Some cadmium workers had been excessively exposed; 25% of them already had signs of kidney dysfunction as evidenced by microproteinuria and/or a serum creatinine level >13 mg/L. No effects were observed on male fertility as evidenced by no significant influence of cadmium on the probability of a live birth. The limitation of this study, as described by the authors, included the fact that the wives were not interviewed and, therefore, factors that could have influenced their reproductive ability were not considered.

Men occupationally exposed to cadmium at levels causing renal damage had no change in testicular endocrine function, as measured by serum levels of testosterone, luteinizing hormone, and follicle-stimulating hormone (Mason 1990).

Noack-Fuller et al. (1993) measured concentrations of cadmium, lead, selenium, and zinc in whole semen and seminal fluid of 22 unexposed men (13 were smokers) to evaluate intra-individual variability and to examine the statistical association between element concentrations and semen characteristics and sperm motion parameters. None of the men had any known occupational exposure to cadmium.

Concentrations of cadmium were similar in semen and seminal plasma (0.40 ± 0.23 and 0.34 ± 0.19 $\mu\text{g/L}$, respectively). Sperm motility ($p < 0.02$), linear velocity ($p < 0.001$), and curvilinear velocity (CV) ($p < 0.002$) were significantly correlated with semen cadmium levels. Intra-individual coefficients of variation for sperm count ($\text{CV} = 46 \pm 4\%$) and sperm concentration ($\text{CV} = 37 \pm 6\%$) showed the highest variability. No positive correlation was found between cadmium concentration in semen and sperm density. The smokers had slightly elevated levels of cadmium. The concentrations of cadmium in semen of these volunteers were very low. Additional studies are needed (preferably with larger sample sizes) to evaluate the robustness of this association between cadmium (at the low levels detected) and sperm motion parameters. Saaranen et al. (1989) measured cadmium, selenium, and zinc in seminal fluid and

3. HEALTH EFFECTS

serum in 64 men, half of whom were smokers. Smokers had significantly higher serum cadmium concentration than nonsmokers. Seminal fluid cadmium was also elevated in smokers, and was higher than serum cadmium in smokers consuming >20 cigarettes daily. Semen quality was measured for volume, sperm density, morphology, motility, and number of immature germ cells. No differences were found in semen quality or fertility between smokers and nonsmokers. There was no significant correlation between seminal fluid cadmium levels and semen quality or fertility.

Xu et al. (1993a) measured trace elements in blood and seminal plasma and their relationship to sperm quality in 221 Singapore men (age range 24–54; mean 34.8) who were undergoing initial screening for infertility. Men with significant past medical history and those who had been occupationally exposed were excluded. Parameters monitored included semen volume and sperm density, motility, morphology, and viability. Graphite furnace atomic absorption was used to determine cadmium concentration in blood and semen. No differences were observed in sperm quality (density, motility, morphology, volume, and viability) of the 221 men compared to a cohort of 38 fertility proven men (wives had recently conceived). Cadmium levels in blood did have a significant inverse relationship with sperm density ($r=-0.15$, $p<0.05$) in oligospermic men (sperm density <20 million/mL), but not in normospermic men. There was a significant reduction in sperm count in men with blood cadmium of >1.5 $\mu\text{g/L}$. Also, there was a weak negative correlation between defective sperm and concentration of cadmium in semen ($r=-0.21$, $p<0.05$). The volume of semen was inversely proportional to the cadmium concentration in semen ($r=-0.29$, $p<0.05$). These findings suggest that cadmium may have an effect on the male reproductive system. Limitations of the study include lack of control for potential confounding factors such as the lower levels of zinc in seminal plasma, and the validity of using infertile men as the study group (i.e., again because of confounding factors that may be affecting both cadmium levels and sperm levels).

A postmortem study of men occupationally exposed to cadmium who died from emphysema found high levels of cadmium in their testes, but no histologic lesions other than those attributable to terminal illness (Smith et al. 1960)

Russian women occupationally exposed to cadmium concentrations up to 35 mg/m^3 had no irregularities in their menstrual cycles (Tsvetkova 1970). Fertility and other indices of reproductive function were not measured. No studies were located that showed reproductive effects in women following inhalation exposure to cadmium.

3. HEALTH EFFECTS

In rats, exposure to cadmium oxide dusts at 1 mg Cd/m³ for 5 hours/day, 5 days/week for 20 weeks, increased the duration of the estrous cycle (Baranski and Sitarek 1987). Male and female rats exposed to cadmium concentrations of 1.06 mg/m³ as cadmium chloride for 6 hours/day, 5 days/week for 62 days and subsequently mated with unexposed controls showed no loss in reproductive success measured by viable embryos and preimplantation losses, but males did have an increased relative testes weight (Kutzman et al. 1986). Similarly, no alterations in fertility in female rats exposed to 0.16 mg Cd/m³ as cadmium oxide for 5 months prior to mating with unexposed males and during the mating and gestation periods (Baranski 1984). Tsvetkova (1970) studied rats exposed to cadmium sulfate aerosols at 2.8 mg Cd/m³ before and during pregnancy. A lengthening of the estrous cycle was observed 2 months after the start of exposure in one-half of the exposed animals. By the fourth month, diestrus was 6.2 days in the exposed group compared to 1.2 days in controls. An increased in estrous cycle length was also observed in rats exposed to 0.88 mg Cd/m³ as cadmium oxide for 13 weeks (NTP 1995); this study also reported a significant decrease in spermatid counts in males exposed to the same cadmium concentration. No other studies were found on reproductive effects in animals. The highest NOAEL values and all LOAEL values from each reliable study for reproductive effects in each species and duration category are recorded in [Table 3-1](#) and plotted in [Figure 3-1](#).

3.2.1.6 Developmental Effects

Russian women occupationally exposed to cadmium at concentrations ranging from 0.02 to 35 mg/m³ had offspring with decreased birth weights compared to unexposed controls, but without congenital malformations (Tsvetkova 1970). No association was found between birth weights of offspring and length of maternal cadmium exposure. Moreover, no control was made for parity, maternal weight, gestational age, or other factors known to influence birth weight (Tsvetkova 1970). A nonsignificant decrease in birth weight was found in offspring of women with some occupational exposure to cadmium in France; however, no adverse effects were documented in these newborns (Huel et al. 1984). Huel et al. (1984) used hair samples to estimate exposure, and this method is limited without controls to distinguish between exogenous and endogenous sources. No other studies were located regarding developmental effects in humans after inhalation exposure to cadmium.

In utero exposure to cadmium results in significant decreases in pup viability, fetal body weight, pup body weight gain, delays in ossification, and impaired performance on neurobehavioral tests. Decreases in pup viability (percentage of pups born alive that survived until postnatal day 4) were observed in the offspring of rats exposed to 0.16 mg Cd/m³ as cadmium oxide for 5 months prior to mating and during

3. HEALTH EFFECTS

mating and gestation day 1–20 (Baranski 1984). Decreases in fetal body weight were observed in the offspring of rats exposed to ≥ 0.581 mg Cd/m³ as cadmium chloride (Prigge 1978b) or cadmium oxide (NTP 1995) and mice exposed ≥ 0.4 mg Cd/m³ as cadmium oxide (NTP 1995); maternal toxicity (decreased body weight gain and/or hypoactivity and dyspnea) were also observed at these exposure levels. Although Baranski (1984) did not find significant alterations in birth weight, a decrease in pup body weight gain was observed in the offspring of rats exposed to 0.16 mg Cd/m³ as cadmium oxide. Delays in skeletal ossification have also been observed in the offspring of rats and mice exposed to 1.7 mg Cd/m³ as cadmium oxide (NTP 1995); although Baranski (1985) also reported a delay in ossification in the offspring of rats, it is unclear whether the effect was observed at 0.02 mg Cd/m³, 0.16 mg Cd/m³, or both.

Baranski (1984, 1985) evaluated the potential of cadmium to induce neurobehavioral effects in the offspring of rats exposed to 0.02 or 0.16 mg Cd/m³ as cadmium oxide for 5 months prior to mating, during mating and gestation day 1–20; the studies reported similar effects and it is unclear whether the papers are reporting the results from separate experiments. The neurobehavioral alterations included decreased exploratory motor activity and avoidance acquisition in 3 month old male and female offspring, respectively, exposed to 0.02 mg Cd/m³. At 0.16 mg Cd/m³, decreased avoidance acquisition in 3 month old female offspring, exploratory motor activity in 3 month old male and female offspring, ambulations in open field test in 5 month old male offspring, and spontaneous mobility in male offspring and prolongation of latency in negative geotaxis test.

3.2.1.7 Cancer

The relationship between occupational exposure to cadmium and increased risk of cancer (particularly lung and prostate cancer) has been explored in a number of occupational exposure studies. The results of these studies are conflicting and the carcinogenicity of cadmium has not been unequivocally established. Overall, the results provide suggestive evidence of an increased risk of lung cancer in humans following prolonged inhalation exposure to cadmium. Initial studies indicated an elevation in prostate cancer among men occupationally exposed to cadmium (Kipling and Waterhouse 1967; Kjellström et al. 1979; Lemen et al. 1976), but subsequent investigations found either no increases in prostate cancer or increases that were not statistically significant (Elinder et al. 1985c; Kazantzis et al. 1988; Sorahan 1987; Sorahan and Esmen 2004; Thun et al. 1985). Based on an analysis of the mortality data from a 5-year update of the cohort from 17 plants in England and a review of the other epidemiological evidence, Kazantzis et al. (1992) concluded that cadmium does not appear to act as a prostatic carcinogen.

3. HEALTH EFFECTS

Significant increases in mortality from lung cancer have been reported in workers employed at a U.S. cadmium recovery facility (Stayner et al. 1992a; Thun et al. 1985), nickel-cadmium battery facilities in England (Sorahan 1987) and Sweden (Järup et al. 1998a), and in a cohort of workers at cadmium processing facilities and/or smelters (Ades and Kazantzis 1988; Kazantzis et al. 1988). However, no clear relationships between level and duration of cadmium exposure and lung cancer risk have been established and many of these studies did not account for confounding exposure to other carcinogenic metals (particularly arsenic and nickel) and cigarette smoking.

The possible association between occupational exposure to cadmium and lung cancer was investigated in several studies of a cohort of workers employed at a U.S. cadmium recovery facility. The cohort was initially examined by Lemen et al. (1976) who found a significant increase in deaths from malignant neoplasms of the respiratory tract among hourly workers employed for at least 2 years between 1940 and 1969. A re-examination of the cohort (deaths through 1978) also found statistically significant standardized mortality rates (SMRs) for malignant neoplasms in the respiratory tract (Thun et al. 1985). To adjust for possible arsenic exposure (between 1918 and 1925, the facility functioned as an arsenic smelter), workers were divided based on year of hire. Mortality from lung cancer was significantly elevated in workers hired prior to 1926 and among workers hired after 1926 with 2 or more years of employment. Dividing the workers into three exposure groups based on estimated cumulative exposure resulted in a significant dose-related trend for lung cancer deaths; in the highest exposure group (cumulative exposures >8 years-mg/m³), a 2- to 8-fold increase in the risk of lung cancer deaths was observed (Thun et al. 1985). A subsequent analysis of these data (workers followed through 1985) used comparisons of rates with the cohort rather than the U.S. population (Stayner et al. 1992a). Lung cancer mortality was significantly increased among non-Hispanic whites, among workers with the highest cumulative exposure ($>2,291$ days-mg/m³), and among workers with the longest time since first exposure (>20 years). Lamm et al. (1992, 1994) used nearly the same data set for the U.S. cohort as Stayner et al. (1992a) in a nested case-control analysis that used the period of hire as a surrogate for arsenic exposure. Based on this analysis as a means to control for the confounding factor of arsenic exposure, Lamm et al. (1992, 1994) reported no residual association of lung cancer with cadmium. They also reported that cases were eight times more likely to have been cigarette smokers than were controls. Lamm et al. (1992, 1994) conclude that arsenic exposure and cigarette smoking were the major determinants of lung cancer risk, not cadmium exposure.

3. HEALTH EFFECTS

The reasons for these conflicting conclusions based on the same cohort data are unclear. Doll (1992) suggested some possible reasons including: (1) that the total number of cases was small ($n=25$) and that only 21 of these cases were included in both studies (i.e., each study included some cases that were not included in the other study); (2) that Stayner et al. (1992a) used national rather than regional mortality rates; (3) that the Lamm et al. (1992, 1994) control series was overmatched, although the matching by date of hire was necessary to control for arsenic exposure; and (4) that there are some concerns about the validity (i.e., biological relevance) of the dose-response-models used by Stayner et al. (1992a). In a response to Doll (1992), Stayner et al. (1993) reported that use of regional mortality rates would increase rather than decrease support for their conclusion, and that the nested case-control analysis of Lamm et al. (1992) used overmatched controls. Stayner et al. (1993) provided additional analyses including the use of the Armitage-Doll multistage model to support the conclusion of an increased risk of cancer from cadmium exposure. Sorahan and Lancashire (1994) subsequently raised concerns about inconsistencies and inaccuracies in the NIOSH job history data used in these studies on the U.S. cohort. Sorahan and Lancashire (1997) then conducted further analyses, based on detailed job histories extracted from time sheet records, to better resolve the potential confounding effects of arsenic. Poisson regression was used to investigate risks of mortality from lung cancer in relation to four concentrations of accumulative exposure to cadmium (<400 , $400-999$, $1,000-1,999$, and $>2,000$ mg-days/m³). After adjustment for age attained, year of hire, and Hispanic ethnicity; Sorahan and Lancashire (1997) report a significant positive trend ($p<0.05$) between cumulative exposure to cadmium and risks of mortality from lung cancer. However, when the exposure to cadmium was evaluated with or without concurrent exposure to arsenic, a significant trend for lung cancer was only found for exposure to cadmium received in the presence of arsenic trioxide. Since there were only 21 deaths from lung cancer, Sorahan and Lancashire (1997) state that it is impossible to determine which of the following three hypotheses is the correct one: (1) cadmium oxide in the presence of arsenic trioxide is a human lung carcinogen, (2) cadmium oxide and arsenic trioxide are human lung carcinogens and cadmium sulphate and cadmium sulphide are not (i.e., cadmium sulphate and cadmium sulphide were the main cadmium compounds of exposure when arsenic was not present), or (3) arsenic trioxide is a human carcinogen and the three cadmium compounds are not carcinogenic.

The carcinogenicity of cadmium has also been examined in European alloy, battery, smelter, and process workers. A study of workers at two copper-cadmium alloy facilities in the United Kingdom found no significant increase in lung cancer mortality (Sorahan et al. 1995). Dividing the workers into groups based on cumulative cadmium exposure or time since first exposure did not result in significant increases in lung cancer deaths in the alloy workers. An initial study of workers at nickel-cadmium battery

3. HEALTH EFFECTS

manufacturing facilities in the United Kingdom found a significant increase in cancer of the respiratory tract (Sorahan and Waterhouse 1983). A subsequent study (Sorahan 1987) found an increase in lung cancer deaths among workers with the highest exposure first employed between 1926 and 1946; no association was found in workers employed after 1946. Another study of nickel-cadmium battery workers in the United Kingdom did not find significant increases in lung cancer deaths (Sorahan and Esmen 2004), although a significant increase in pharyngeal cancer deaths was observed. A study of nickel cadmium battery workers in Sweden found an increase in lung cancer mortality, but the increase was not statistically significant (Elinder et al. 1985c). An update of this study, which includes additional workers, found a significant increase in lung cancer deaths (Järup et al. 1998a). However, there was no exposure-response relationship between cumulative exposure to cadmium (or nickel) and the risk of lung cancer. A significant increase in lung cancer mortality was observed in workers employed at a zinc-lead-cadmium smelter (Ades and Kazantzis 1988). However, no relationship between cumulative cadmium exposure and lung cancer deaths was found, suggesting that cadmium was not the causative agent. Another study of workers in 19 facilities in the United Kingdom that process cadmium did not find a statistically significant increase in lung cancer deaths (Armstrong and Kazantzis 1983). An update of this study found a significant increase in lung cancer deaths (Kazantzis et al. 1988). However, >60% of the lung cancer deaths were workers at the zinc-lead-cadmium smelter examined by Ades and Kazantzis (1988).

Studies in rats provide strong evidence of the lung carcinogenic potential of chronically inhaled cadmium. Oldiges et al. (1989) reported a clear dose response increase in lung tumors in male and female rats from an 18-month continuous exposure to either cadmium chloride, cadmium oxide dusts, cadmium oxide fume, cadmium sulfate, or cadmium sulfide. In the cadmium chloride study at $30 \mu\text{g}/\text{m}^3$, the observation period in the males had to be shortened to 30 months (rather than 31) because of mortality in excess of 75%. No lung tumors were observed in control rats after 31 months of observation. A high incidence of nodules and tumors was seen in $30 \mu\text{g}/\text{m}^3$ exposures to cadmium chloride in both males and females. Results showed lung nodules in 18 of 20 males and 15 of 18 females and primary lung tumors in 15 of 20 males and 13 of 18 females. Tumor incidence as bronchioalveolar adenomas, adenocarcinomas, squamous cell carcinomas, or combined epidermoid carcinoma and adenocarcinoma were 2, 12, 0, and 1 for males; and 4, 7, 0, and 2 for females, respectively. Increased lung tumors in males and females were also observed with chronic exposures to cadmium oxide dust or fume at $30 \mu\text{g}/\text{m}^3$, to cadmium sulfate at $90 \mu\text{g}/\text{m}^3$, and to cadmium sulfide at $90 \mu\text{g}/\text{m}^3$ (Oldiges et al. 1989). Cadmium sulfate produced by photolysis of cadmium sulfide under the experimental conditions may have contributed to some of the response observed with cadmium sulfide (Konig et al. 1992).

3. HEALTH EFFECTS

Takenaka et al. (1983) also demonstrated cadmium carcinogenicity in male rats exposed to cadmium chloride aerosols at 0.0134, 0.0257, and 0.0508 mg Cd/m³ for 18 months. The exposure produced a dose-related increase in lung epidermoid carcinomas, adenocarcinomas, and mucoepidermoid carcinomas starting at 20 months. No other type of tumor was observed to increase with increasing dose.

In a protocol similar to the studies by Oldiges et al. (1989), Heinrich et al. (1989) did not observe an increase in lung tumors in male or female Syrian golden hamsters from chronic inhalation exposure to either cadmium oxide dust or fumes, cadmium chloride, cadmium sulfate, or cadmium sulfide. In female mice, lung tumor incidence increased at all dose levels, but incidence in the controls was also high, and the cadmium-induced increases were not statistically significant. Lung tumors in the cadmium-treated mice also did not increase in a dose-responsive manner except for a weak increase from exposure to the cadmium oxide fumes (Heinrich et al. 1989).

The available data provide inconclusive evidence on the potential of cadmium to induce lung cancer in humans. The strongest evidence comes from early studies of workers at a U.S. cadmium recovery facility (Stayner et al. 1992a; Thun et al. 1985), but later examinations of this cohort did not find conclusive evidence (Lamm et al. 1992, 1994; Sorahan and Lancashire 1997). The inconsistent results may be due to the small number of lung cancer cases and adjustments for possible early exposure to arsenic. Some studies of European cadmium workers have found significant increases in lung cancer (Ades and Kazantzis 1988; Järup et al. 1998a; Kazantzis et al. 1988; Sorahan 1987; Sorahan and Waterhouse 1983), but lung cancer deaths were not significantly associated with cumulative cadmium levels or duration of exposure and the investigators concluded that the effects may not have been related to cadmium exposure. Based on an early 1990s analysis of the available human and animal data, IARC (1993) classified cadmium as carcinogenic to humans (Group 1), based on sufficient evidence for carcinogenicity in both human and animal studies. Similarly, the DHHS (NTP 2011) classified cadmium and certain cadmium compounds as substances known to be human carcinogens. EPA classified cadmium as a probable human carcinogen by inhalation (Group B1), based on limited evidence of an increase in lung cancer in humans and sufficient evidence of lung cancer in rats (IRIS 2012). EPA estimated an inhalation unit risk (the risk corresponding to lifetime exposure to 1 µg/m³) of 1.8x10⁻³ based on the Thun et al. (1985) study (IRIS 2012). A range of concentrations that correspond to upper bound lifetime excess risks of 10⁻⁴–10⁻⁷ is shown in [Figure 3-1](#).

3. HEALTH EFFECTS

3.2.2 Oral Exposure

Information on health effects of oral exposure to cadmium in humans is derived mainly from studies of residents living in cadmium-polluted areas. Cadmium exposure in these populations is often estimated by blood or urinary cadmium levels (see Section 3.8.1). Exposure in these cases occurs primarily through the diet, but smokers in these cohorts are also exposed to cadmium by inhalation. When evaluating oral exposure studies, smoking was treated as a confounding variable rather than an exposure route because of the large number of toxic compounds (in addition to cadmium) present in cigarette smoke, and because the primary concern is effects attributable to cadmium. Cadmium is more readily found in the free ionic form in water, while in food, the cadmium ion generally exists in a complex with a variety of ligands, including proteins such as metallothionein (Crews et al. 1989; Groten et al. 1990; Nordberg et al. 1986). Experimental studies in animals have generally used soluble salts of cadmium (such as cadmium chloride) for food, drinking water, and gavage exposures. The toxicological properties of the cadmium ion do not appear to depend on the counter ion, although absorption may be significantly affected by protein complexes (see Section 3.3.1.2).

3.2.2.1 Death

Intentional ingestion of cadmium has been used as a means of suicide, causing death due to massive fluid loss, edema, and widespread organ destruction (Buckler et al. 1986; Wisniewska-Knypl et al. 1971). The doses ingested in two known fatal cases were estimated to be 25 mg Cd/kg from cadmium iodide (Wisniewska-Knypl et al. 1971) and 1,840 mg Cd/kg from cadmium chloride (Buckler et al. 1986). Time to death after cadmium iodide ingestion was 7 days (Wisniewska-Knypl et al. 1971) and 33 hours after ingestion of the cadmium chloride (Buckler et al. 1986).

In rats and mice, acute oral LD₅₀ (lethal dose, 50% kill) values for cadmium range from about 100 to 300 mg/kg (Baer and Benson 1987; Basinger et al. 1988; Kostial et al. 1978; Kotsonis and Klaassen 1978; Shimizu and Morita 1990). The lowest dose causing death (2 of 20 animals) was 15.3 mg/kg in Sprague-Dawley rats (Borzelleca et al. 1989). Very young animals have lower LD₅₀ values than adult animals (Kostial et al. 1978, 1989); this effect may be related to the greater fractional absorption of ingested cadmium in the immature organism (see Section 3.4.1.2). For example, the LD₅₀ values in rats aged 2, 3, 6, 18, and 54 week are 47, 240, 216, 170, and 109 mg/kg, respectively (Kostial et al. 1978).

Deaths related to cadmium exposure have been reported in only two of the intermediate exposure studies found. In a study in Wistar rats exposed to cadmium chloride by gavage at 40 mg Cd/kg/day,

3. HEALTH EFFECTS

5 days/week for up to 14 weeks; 4 of 13 female Wistar rats died by 8 weeks (Baranski and Sitarek 1987). In mice, Blakley (1986) studied the effect of cadmium on chemical- and viral-induced tumor production. Female albino Swiss mice (8 weeks old, n=41) were administered cadmium chloride in the drinking water for 280 days at doses of 0, 5, 10, or 50 ppm. These mice have a high incidence of spontaneous lymphocytic leukemia of thymic origin. A significant 33% increase ($p=0.0228$, chi-square analysis) in deaths from virally induced leukemia was observed from exposure to 1.9 or 9.5 mg Cd/kg/day. The deaths were attributed to cadmium-impaired immunosurveillance mechanisms that control expression of the murine lymphocytic leukemia virus.

The LOAEL values from each reliable study for lethality in each species and duration category are recorded in [Table 3-6](#) and plotted in [Figure 3-2](#).

3.2.2.2 Systemic Effects

The highest NOAEL values and all LOAEL values from each reliable study for systemic effects in each species and duration category are recorded in [Table 3-6](#) and plotted in [Figure 3-2](#).

Respiratory Effects. No studies were located regarding respiratory effects in humans after oral exposure to cadmium.

No respiratory effects were observed in Rhesus monkeys from 4 mg/kg/day of cadmium chloride in the food for 9 years (Masaoka et al. 1994). Intermediate-duration oral exposure caused fibrosis in lungs of rats exposed to 2.4 mg Cd/kg/day of cadmium chloride after 6 and 16 weeks (Miller et al. 1974b). Petering et al. (1979) observed a reduced static compliance and lung lesions (not specified) in male Sprague-Dawley rats exposed to 1.2 mg Cd/kg/day in water for 200 days. Zinc-deficient rats were more susceptible to lung lesions from exposure to cadmium chloride (Petering et al. 1979). Rats exposed to cadmium chloride at 3.62 mg Cd/kg/day in the drinking water for 120 days developed emphysema (Petering et al. 1979). No histopathologic lesions of the lung were found in male Sprague-Dawley rats after 24 weeks of exposure to cadmium in drinking water at a maximum dose of 8 mg/kg/day (Kotsonis and Klaassen 1978). Lung weight was unchanged in Wistar rats after 90 days of exposure in drinking water at 16 mg/kg/day (Prigge 1978a). Effects on the lung following oral exposure to cadmium may be secondary to systemic changes (Petering et al. 1979); however, the studies that found lung effects did not examine other systemic effects in the exposed rats (Miller et al. 1974b; Petering et al. 1979).

Table 3-6 Levels of Significant Exposure to Cadmium - Oral

Key to Figure ^a	Species (Strain)	Exposure/Duration/Frequency (Route)	System	NOAEL (mg/kg/day)	LOAEL		Reference	Comments
					Less Serious (mg/kg/day)	Serious (mg/kg/day)		
ACUTE EXPOSURE								
Death								
1	Rat (NS)	once (G)				29 (LD50 at 8 days; 2 weeks old)	Kostial et al. 1978 CdCl ₂	
						129 F (LD50 at 8 days; 6 weeks old)		
						104 F (LD50 at 8 days; 18 weeks old)		
2	Rat (Sprague-Dawley)	once (GW)				225 M (LD50 at 14 days)	Kotsonis and Klaassen 1977 CdCl ₂	
3	Rat (Sprague-Dawley)	2 wk (W)				42 M (7/9 died within 2 weeks)	Kotsonis and Klaassen 1978 CdCl ₂	
4	Rat (Sprague-Dawley)	once (GW)				327 M (LD50 at 24 hours; fed rats)	Shimizu and Morita 1990 CdCl ₂	
						107 M (LD50 at 24 hours; fasted rats)		
5	Mouse (Swiss-Webster)	once (GW)				95.5 M (LD50 at 96 hours)	Baer and Benson 1987 CdCl ₂	
6	Mouse (ICR)	once (GW)				112 M (5/10 died within 8 days)	Basinger et al. 1988 CdCl ₂	

Table 3-6 Levels of Significant Exposure to Cadmium - Oral

(continued)

Key to Figure	Species (Strain)	Exposure/Duration/Frequency (Route)	System	NOAEL (mg/kg/day)	LOAEL		Reference Chemical Form	Comments
					Less Serious (mg/kg/day)	Serious (mg/kg/day)		
Systemic								
7	Rat (Wistar)	10 d Gd 7-16 once (GW)	Bd Wt	2 F	12 F (14% decreased maternal body weight)		Baranski 1985 CdCl ₂	
8	Rat (Sprague-Dawley)	10 d 1 x/d (GW)	Hemato	31.3 M 138 F	65.6 M (increased hemoglobin, hematocrit, erythrocytes)		Borzelleca et al. 1989 CdCl ₂	
			Hepatic	65.6 M	138 M (focal necrosis of hepatocytes)			
			Renal		15.3 (focal necrosis of tubular epithelium)			
			Bd Wt	15.3 M (18% decreased body weight) 31.3 F 65.6 F (18% decreased body weight)	31.3 M (23% decreased body weight)			
9	Rat (Sprague-Dawley)	10 d (W)	Hepatic	13.9			Borzelleca et al. 1989 CdCl ₂	
			Renal	13.9				
			Bd Wt	13.9 1.1 M	7.8 M (14% decreased body weight)	11.2 M (25% decreased body weight)		

Table 3-6 Levels of Significant Exposure to Cadmium - Oral

(continued)

Key to Figure ^a	Species (Strain)	Exposure/Duration/Frequency (Route)	System	NOAEL (mg/kg/day)	LOAEL		Reference Chemical Form	Comments
					Less Serious (mg/kg/day)	Serious (mg/kg/day)		
10	Rat (Sprague-Dawley)	once (GW)	Cardio	150 M			Kotsonis and Klaassen 1977 CdCl ₂	
			Hemato	150 M				
			Hepatic	150 M				
			Renal		25 M (50% decrease in urine flow for first 2 days)			
			Bd Wt	100	150 M (initial 12% decreased body weight)			
11	Rat (Long-Evans)	Gd 6-15 (GW)	Gastro	6.13 F		61.32 F (intestinal necrosis, hemorrhage, ulcers)	Machemer and Lorke 1981 CdCl ₂	
			Bd Wt	1.84 F	6.13 F (27% decrease in body weight gain during treatment)	18.39 F (persistent 50% decrease in maternal body weight gain)		
12	Rat (Long-Evans)	Gd 6-15 (F)	Gastro	12.5 F			Machemer and Lorke 1981 CdCl ₂	
			Bd Wt	3.5 F	12.5 F (transient 19% decrease in maternal body weight gain during treatment)			
13	Rat (Wistar)	12 d (W)	Hemato		12 M (anemia)		Sakata et al. 1988 CdCl ₂	

Table 3-6 Levels of Significant Exposure to Cadmium - Oral

(continued)

Key to Figure ^a	Species (Strain)	Exposure/Duration/Frequency (Route)	System	LOAEL			Reference Chemical Form	Comments
				NOAEL (mg/kg/day)	Less Serious (mg/kg/day)	Serious (mg/kg/day)		
14	Rat (Sprague-Dawley)	once (GW)	Hepatic		75 M (focal degeneration and necrosis of parenchymal cells)		Shimizu and Morita 1990 CdCl ₂	
15	Mouse (CBA/Bom)	once (GW)	Gastro	15.7 M	30.4 M (gastritis and enteritis)	88.8 M (severe gastric necrosis)	Andersen et al. 1988 CdCl ₂	
			Hepatic	15.7 M	30.4 M (fatty infiltration of liver cells, occasional hepatocellular necrosis)			
			Renal	59.6		88.8 M (tubular necrosis and casts)		
16	Mouse (ICR)	once (GW)	Gastro			112 M (glandular stomach epithelial necrosis)	Basinger et al. 1988 CdCl ₂	
			Hepatic			112 M (extensive hepatocellular coagulative necrosis)		
			Renal	112 M				
Immuno/ Lymphoret								
17	Rat (Sprague-Dawley)	10 d 1 x/d (GW)		65.6 M 31.3 F	65.6 F (increased leukocyte counts)		Borzelleca et al. 1989 CdCl ₂	
Neurological								
18	Rat (Sprague-Dawley)	once (GW)		25 M	50 M (decreased motor activity)		Kotsonis and Klaassen 1977 CdCl ₂	

Table 3-6 Levels of Significant Exposure to Cadmium - Oral

(continued)

Key to Figure ^a	Species (Strain)	Exposure/ Duration/ Frequency (Route)	System	NOAEL (mg/kg/day)	LOAEL		Reference Chemical Form	Comments
					Less Serious (mg/kg/day)	Serious (mg/kg/day)		
Reproductive								
19	Rat (Wistar)	once (GW)		50 M		100 M (testicular necrosis)	Bomhard et al. 1987 CdCl ₂	
20	Rat (Sprague- Dawley)	10 d 1 x/d (GW)		138 F		65.6 M (testicular atrophy and loss of spermatogenic elements)	Borzelleca et al. 1989 CdCl ₂	
21	Rat (Sprague- Dawley)	once (GW)		25 M			Dixon et al. 1976 CdCl ₂	
22	Rat (Sprague- Dawley)	once (GW)		50 M		100 M (testicular necrosis; decreased spermatogenesis; decreased number females producing pups)	Kotsonis and Klaassen 1977 CdCl ₂	
23	Mouse (CBM/ Bom)	once (GW)		30.3 M		59.6 M (testicular necrosis)	Andersen et al. 1988 CdCl ₂	
Developmental								
24	Rat (Wistar)	10 d Gd 7-16 once (GW)			2 F (delayed ossification of the sternum and ribs)	40 (fused lower limbs, absent limbs, decreased number of live fetuses, increased number of resorptions)	Baranski 1985 CdCl ₂	

Table 3-6 Levels of Significant Exposure to Cadmium - Oral

(continued)

Key to Figure	Species (Strain)	Exposure/Duration/Frequency (Route)	System	NOAEL (mg/kg/day)	LOAEL		Reference Chemical Form	Comments
					Less Serious (mg/kg/day)	Serious (mg/kg/day)		
25	Rat (Long- Evans)	1 x/d Gd 6-15 (GW)		6.13		18.39	(increased number of fetuses with malformations)	Machemer and Lorke 1981 CdCl ₂
26	Rat (Long- Evans)	10 d Gd 6-15 (F)		12.5				Machemer and Lorke 1981 CdCl ₂
INTERMEDIATE EXPOSURE								
Death								
27	Rat (Wistar)	14 wk 5 d/wk (GW)				40 F	(4/13 died by week 8; 7/13 by week 14)	Baranski and Sitarek 1987 CdCl ₂
28	Mouse (Swiss)	280 d (W)				1.9 F	(24/41 died by 280 days)	Blakley 1986 CdCl ₂
Systemic								
29	Monkey (Rhesus)	10 wk (F)	Bd Wt	5 M				Chopra et al. 1984 CdCl ₂
30	Rat (Wistar)	14 wk 5 d/wk (GW)	Bd Wt	4 F		40 F	(29% decreased maternal body weight)	Baranski and Sitarek 1987 CdCl ₂
31	Rat (Sprague-Dawley)	2-10 mo (W)	Renal			30 F	(B2-microglobulinuria)	Bernard et al. 1988a CdCl ₂

Table 3-6 Levels of Significant Exposure to Cadmium - Oral

(continued)

Key to Figure ^a	Species (Strain)	Exposure/Duration/Frequency (Route)	System	NOAEL (mg/kg/day)	LOAEL		Reference Chemical Form	Comments
					Less Serious (mg/kg/day)	Serious (mg/kg/day)		
32	Rat (Wistar)	daily 12 mo (W)	Musc/skel	0.2 M	0.5 M (increased lumbar spine deformities, decreased in lumbar spine and femur mineralization, altered bone turnover parameters)		Brzoska and Moniuszko-Jakoniuk 2005a, 2005b; Brzoska et al. 2010 CdCl ₂	
33	Rat (Wistar)	daily 12 mo (W)	Musc/skel		^b 0.2 F (decreased bone mineralization, mechanical properties of tibia and femur, and altered bone turnover parameters)		Brzoska and Moniuszko-Jakoniuk 2005d; Brzoska et al. 2005a, 2005c CdCl ₂	
34	Rat (Wistar)	daily 12 mo (W)	Musc/skel		0.3 F (alterations in bone mineral content and density and mechanical properties of lumbar vertebral and femoral bones)		Brzoska et al. 2004b, 2005b CdCl ₂	
35	Rat (Sprague-Dawley)	4 or 7 mo (W)	Renal			15.2 F (albuminuria, transferrinuria, B ₂ -microglobulinuria)	Cardenas et al. 1992a CdCl ₂	
36	Rat (Sprague-Dawley)	190 d (W)	Cardio		1.4 M (20% increase in diastolic blood pressure)		Carmignanti and Boscolo 1984 Cd acetate	
			Bd Wt	2.8 M				

Table 3-6 Levels of Significant Exposure to Cadmium - Oral

(continued)

Key to Figure	Species (Strain)	Exposure/Duration/Frequency (Route)	System	NOAEL (mg/kg/day)	LOAEL		Reference Chemical Form	Comments
					Less Serious (mg/kg/day)	Serious (mg/kg/day)		
37	Rat (Sprague-Dawley)	12 wk (W)	Hepatic		8.58 M (necrosis of central lobules)		Cha 1987 CdCl ₂	
			Renal		8.58 M (necrosis of proximal tubular epithelial cells and cloudy swelling)			
			Bd Wt		8.58 M (23% decreased in body weight gain; 9% total body weight decrease)			
38	Rat (Wistar)	170 d (W)	Bd Wt	56 F			Cifone et al. 1989a CdCl ₂	
39	Rat (Sprague-Dawley)	3 mo (W)	Hemato		2 (anemia)		Decker et al. 1958 CdCl ₂	
			Bd Wt		2 F (15% decreased body weight)	2 M (25% decreased body weight)		
40	Rat (Wistar)	4-60 wk (W)	Renal		1.18 (vesiculation of proximal tubules)		Gatta et al. 1989 CdCl ₂	
41	Rat	4 wk (F)	Hemato		2.5 M (anemia)		Groten et al. 1990 CdCl ₂	
			Renal	2.5 M				

Table 3-6 Levels of Significant Exposure to Cadmium - Oral

(continued)

Key to Figure	Species (Strain)	Exposure/Duration/Frequency (Route)	System	NOAEL (mg/kg/day)	LOAEL		Reference Chemical Form	Comments
					Less Serious (mg/kg/day)	Serious (mg/kg/day)		
42	Rat (Wistar)	120 d (W)	Hemato		3.6 M (anemia)		Itokawa et al. 1974 CdCl ₂	
			Renal		3.6 M (tubular necrosis and casts, glomerular adhesions)			
43	Rat (Sprague-Dawley)	7 wk (F)	Cardio			2.5 M (congested myocardium, separation of muscle fibers)	Jamall et al. 1989 CdCl ₂	
			Renal	2.5 M				
			Bd Wt	2.5 M				
44	Rat (Wistar)	90 d (W)	Hemato		8 F (anemia)		Kawamura et al. 1978 CdCl ₂	
			Musc/skel		8 F (osteomalacia changes)			
			Renal		8 F (decreased renal clearance)			
			Endocr	8 F				
			Bd Wt		8 F (12% decreased body weight)			
45	Rat (Sprague-Dawley)	22 d Gd 0-21 (W)	Hemato		1.5 F (slight anemia)		Kelman et al. 1978 form not specified	
			Musc/skel	3.8 F				

Table 3-6 Levels of Significant Exposure to Cadmium - Oral

(continued)

Key to Figure ^a	Species (Strain)	Exposure/ Duration/ Frequency (Route)	System	NOAEL (mg/kg/day)	LOAEL		Reference Chemical Form	Comments
					Less Serious (mg/kg/day)	Serious (mg/kg/day)		
46	Rat (Sprague- Dawley)	24 wk (W)	Resp	8 M			Kotsonis and Klaassen 1978 CdCl ₂	
			Cardio	8 M				
			Gastro	8 M				
			Hemato	8 M				
			Musc/skel	8 M				
			Hepatic	8 M				
			Renal	1.2 M	3.1 M (proteinuria, slight focal tubular necrosis)			
			Endocr	8 M				
Bd Wt	8 M							
47	Rat (Wistar)	8 weeks daily (W)	Hepatic		18 M (increased serum and liver triglyceride levels; increased serum cholesterol levels)		Larregle et al. 2008 CdCl ₂	
48	Rat (Wistar)	3 mo (F)	Cardio	3			Loeser and Lorke 1977a CdCl ₂	
			Hemato	3				
			Hepatic	3				
			Renal	3				
			Endocr	3				
			Bd Wt	3				

Table 3-6 Levels of Significant Exposure to Cadmium - Oral

(continued)

Key to Figure ^a	Species (Strain)	Exposure/Duration/Frequency (Route)	System	NOAEL (mg/kg/day)	LOAEL		Reference Chemical Form	Comments
					Less Serious (mg/kg/day)	Serious (mg/kg/day)		
49	Rat (Sprague-Dawley)	6-16 wk (W)	Resp			2.4 (lung fibrosis)	Miller et al. 1974b CdCl ₂	
50	Rat (Sprague-Dawley)	6 wk 5 d/wk 1 x/d (GW)	Hepatic	0.25 M			Muller et al. 1988 Cd acetate	
			Bd Wt	0.25 M				
51	Rat (NS)	4 wk (W)	Hemato		0.8 F (decreased hematocrit and hemoglobin)		Ogoshi et al. 1989 CdCl ₂	
			Musc/skel		0.8 F (decreased bone strength in young animals)			
			Bd Wt	0.8	1.6 F (10% decreased body weight gain)			
52	Rat (NS)	200 d (W)	Resp	0.6 M	1.2 M (reduced static compliance, lung lesions)		Petering et al. 1979 CdCl ₂	
53	Rat (Sprague-Dawley)	120 d (W)	Resp			3.62 M (emphysema)	Petering et al. 1979 CdCl ₂	

Table 3-6 Levels of Significant Exposure to Cadmium - Oral

(continued)

Key to Figure ^a	Species (Strain)	Exposure/Duration/Frequency (Route)	System	NOAEL (mg/kg/day)	LOAEL		Reference Chemical Form	Comments
					Less Serious (mg/kg/day)	Serious (mg/kg/day)		
54	Rat (Sprague-Dawley)	111 d (90 d prior to Gd 1-21) (W)	Hemato	5.23 F			Petering et al. 1979 CdCl ₂	
55	Rat (Sprague-Dawley)	Gd 1- Ld 1 (F)	Bd Wt			19.7 F (77-80% decreased maternal weight gain)	Pond and Walker 1975 CdCl ₂	
56	Rat (Wistar)	90 d (W)	Resp	16 F			Prigge 1978a CdCl ₂	
			Hemato		4 F (23% decreased serum iron)			
			Renal	4 F	8 F (35% increase in urine protein)			
56	Rat (Wistar)	90 d (W)	Bd Wt	8 F				
57	Rat (Wistar)	12, 26, 50, or 100 d (W)	Hemato			12 M (iron deficient anemia)	Sakata et al. 1988 CdCl ₂	
58	Rat (Sprague-Dawley)	7-12 mo (W)	Renal	13 F			Viau et al. 1984 CdCl ₂	
			Bd Wt	13 F				

Table 3-6 Levels of Significant Exposure to Cadmium - Oral

(continued)

Key to Figure	Species (Strain)	Exposure/Duration/Frequency (Route)	System	NOAEL (mg/kg/day)	LOAEL		Reference Chemical Form	Comments
					Less Serious (mg/kg/day)	Serious (mg/kg/day)		
59	Mouse (CF1)	252 d (F)	Musc/skel		0.65 F (decrease in femur calcium content in mice undergoing repeated pregnancy/lactation periods)		Bhattacharyya et al. 1988a, 1988b	
60	Mouse (C57BL/6)	3-11 wk (W)	Bd Wt			12.5 M (63% decreased body weight gain)	Malave and de Ruffino 1984 CdCl ₂	
61	Mouse (B6C3F1)	16-46 wk (W)	Bd Wt			232 M (45% decreased body weight)	Waalkes et al. 1993 CdCl ₂	
62	Mouse (QS/CH)	Gd 1-19 (W)	Hemato	4.8 F	9.6 F (anemia)		Webster 1978 CdCl ₂	
			Bd Wt	4.8 F	9.6 F (14% decrease in maternal weight gain)			
63	Dog (Beagle)	3 mo (F)	Cardio	0.75			Loeser and Lorke 1977b CdCl ₂	
			Hemato	0.75				
			Hepatic	0.75				
			Renal	0.75				
			Bd Wt	0.75				

Table 3-6 Levels of Significant Exposure to Cadmium - Oral

(continued)

Key to Figure	Species (Strain)	Exposure/ Duration/ Frequency (Route)	System	NOAEL (mg/kg/day)	LOAEL		Reference Chemical Form	Comments
					Less Serious (mg/kg/day)	Serious (mg/kg/day)		
64	Rabbit (New Zealand)	9 mo (W)	Cardio		1.6 M (increased aortic resistance, reduced contractility)		Boscolo and Carmignani 1986 CdCl ₂	
			Renal	1.6 M				
			Bd Wt	1.6 M				
65	Rabbit (New Zealand (W) and Belgian Giant)	200 d (W)	Hemato		14.9 M (anemia)		Stowe et al. 1972 CdCl ₂	
			Hepatic		14.9 M (focal hepatic fibrosis and biliary hyperplasia)			
			Renal			14.9 M (tubular necrosis, glomerular and interstitial fibrosis)		
			Endocr	14.9				
			Bd Wt		14.9 M (11% decrease in body weight)			
Immuno/ Lymphoret								
66	Monkey (Rhesus)	10 wk (F)			5 M (increased cell-mediated immune response)		Chopra et al. 1984 CdCl ₂	
67	Rat (Wistar)	170 d (W)			28 F (biphasic decrease then increase in natural killer cell activity)		Cifone et al. 1989a CdCl ₂	

Table 3-6 Levels of Significant Exposure to Cadmium - Oral

(continued)

Key to Figure ^a	Species (Strain)	Exposure/Duration/Frequency (Route)	System	NOAEL (mg/kg/day)	LOAEL		Reference Chemical Form	Comments
					Less Serious (mg/kg/day)	Serious (mg/kg/day)		
68	Rat (Wistar)	3 mo (F)		3			Loeser and Lorke 1977a CdCl ₂	
69	Mouse (BDF1)	3 wk (W)		1.4 F	2.8 F (decreased humoral immune response)		Blakley 1985 CdCl ₂	
70	Mouse (Swiss)	280 d (W)			1.9 F (greater susceptibility to murine lymphocytic leukemia virus)		Blakley 1986 CdCl ₂	
71	Mouse (BDF1)	26 d (W)		12.5 F			Blakley 1988 CdCl ₂	
72	Mouse (Swiss-Webster)	30 d (W)		22 M			Bouley et al. 1984 Cd acetate	
73	Mouse (Swiss-Webster)	10 wk (W)		57 M			Exon et al. 1986 CdCl ₂ , Cd acetate, or Cd sulfate	
74	Mouse (C57BL/6N)	12-16 wk (W)		19 F	57 F (reduced number of SRBC-activated, plaque-forming cells)		Krzystyniak et al. 1987 CdCl ₂	

Table 3-6 Levels of Significant Exposure to Cadmium - Oral

(continued)

Key to Figure	Species (Strain)	Exposure/Duration/Frequency (Route)	System	NOAEL (mg/kg/day)	LOAEL		Reference Chemical Form	Comments
					Less Serious (mg/kg/day)	Serious (mg/kg/day)		
75	Mouse (C57BL/6)	3-11 wk (W)			12.5 M (decreased suppressor cell activity)		Malave and de Ruffino 1984 CdCl ₂	
76	Mouse (ICR)	10 wk (W)			0.75 M (induction of anti-nuclear autoantibodies)		Ohsawa et al. 1988 CdCl ₂	
Neurological								
77	Rat (Wistar)	14 wk 5 d/wk (GW)		4 F	40 F (aggressive behavior)		Baranski and Sitarek 1987 CdCl ₂	
78	Rat (Sprague-Dawley)	3-24 wk (W)		1.2 M	3.1 M (decreased motor activity)		Kotsonis and Klaassen 1978 CdCl ₂	
79	Rat (Sprague-Dawley)	55 d (F)		1 M	5 M (increased passive avoidance)		Nation et al. 1984 CdCl ₂	
80	Rat (Sprague-Dawley)	60 d (F)			9 M (decreased motor activity)		Nation et al. 1990 CdCl ₂	
Reproductive								
81	Rat (Wistar)	14 wk 5 d/wk (GW)		4 F	40 F (increased duration of estrus cycle)		Baranski and Sitarek 1987 CdCl ₂	

Table 3-6 Levels of Significant Exposure to Cadmium - Oral

(continued)

Key to Figure	Species (Strain)	Exposure/Duration/Frequency (Route)	System	NOAEL (mg/kg/day)	LOAEL		Reference Chemical Form	Comments
					Less Serious (mg/kg/day)	Serious (mg/kg/day)		
82	Rat (Wistar)	11 wk 5 d/wk (GW)		4 F			Baranski et al. 1983 CdCl ₂	
83	Rat (Wistar)	10 wk 1 x/wk (GW)		5 M			Bomhard et al. 1987 CdCl ₂	Histopathology only.
84	Rat (Sprague-Dawley)	12 wk (W)			8.58 M (necrosis and atrophy of seminiferous tubule epithelium)		Cha 1987 CdCl ₂	
85	Rat	4 wk (F)		2.5 M			Groten et al. 1990 CdCl ₂	Histopathology only.
86	Rat (albino)	4 wk (W)		4.8 F			Kostial et al. 1993 CdCl ₂	
87	Rat (Sprague-Dawley)	24 wk (W)		8 M			Kotsonis and Klaassen 1978 CdCl ₂	
88	Rat (Wistar)	3 mo (F)		3			Loeser and Lorke 1977a CdCl ₂	Histopathology only.
89	Rat (NS)	120 d (W)			12.6 M (decreased sperm count and motility, seminiferous tubular damage)		Saxena et al. 1989 Cd acetate	

Table 3-6 Levels of Significant Exposure to Cadmium - Oral

(continued)

Key to Figure ^a	Species (Strain)	Exposure/ Duration/ Frequency (Route)	System	NOAEL (mg/kg/day)	LOAEL		Reference Chemical Form	Comments
					Less Serious (mg/kg/day)	Serious (mg/kg/day)		
90	Rat (Long- Evans)	70-80 d (W)		4.64 M			Zenick et al. 1982 CdCl ₂	
91	Dog (Beagle)	3 mo (F)		0.75			Loeser and Lorke 1977b CdCl ₂	
Developmental								
92	Rat (Wistar)	21 d Gd 1-21 (W)			0.706	(delayed development of sensory motor coordination reflexes; increased motor activity)	Ali et al. 1986 Cd acetate	
93	Rat (Wistar)	20 d Gd 1-20 (W)			9.6	(decreased fetal body weight [12%], body length [7%], and hematocrit [13%])	Baranski 1987 CdCl ₂	Decreased maternal water and food consumption.
94	Rat (Wistar)	11 wk 5 d/wk 1 x/d (GW)			0.04	(pup behavioral alterations)	Baranski et al. 1983 CdCl ₂	

Table 3-6 Levels of Significant Exposure to Cadmium - Oral

(continued)

Key to Figure ^a	Species (Strain)	Exposure/ Duration/ Frequency (Route)	System	NOAEL (mg/kg)	LOAEL		Reference Chemical Form	Comments
					Less Serious (mg/kg)	Serious (mg/kg)		
95	Rat (Wistar)	11-94 d Gd 5-15 Ld 2-28 1 x/d ppd 1-56 5 d/wk 1 x/d (GW)			14 M (decreased horizontal ambulation and rearing activity; increased frequency of somatosensory, visual, and auditory electrocorticogram; prolonged latency and duration of evoked potentials)		Desi et al. 1998 CdCl ₂	
96	Rat (Druckery)	Gd 0- Ld 21 (W)			5 (decreased pup brain and body weight at 7, 14, and 21 days)		Gupta et al 1993 Cd acetate	
97	Rat (Sprague- Dawley)	Gd 0-20 (W)			1.5 (12% decreased hematocrit)		Kelman et al. 1978 form not specified	
98	Rat (albino)	10 wk (W)			4.8 (12% decrease in pup body weight at weaning)		Kostial et al. 1993 CdCl ₂	
99	Rat (Wistar)	approx. 49 d 4 wk old through mating 7 d/wk 1 x/d (GO)			7 M (alterations in ambulation behavior; prolonged latency and duration of somatosensory evoked potentials)		Nagymajtenyi et al. 1997 CdCl ₂	

Table 3-6 Levels of Significant Exposure to Cadmium - Oral

(continued)

Key to Figure ^a	Species (Strain)	Exposure/Duration/Frequency (Route)	System	NOAEL (mg/kg/day)	LOAEL		Reference Chemical Form	Comments
					Less Serious (mg/kg/day)	Serious (mg/kg/day)		
100	Rat (Sprague-Dawley)	60 d prior to Gd 1 or Gd 1-21 (W)			2.61	(decreased live birth weight)	Petering et al. 1979 CdCl ₂	
101	Rat (Sprague-Dawley)	Gd 1- Ld 1 (F)			19.7	(13-19% decreased pup birth weight)	Pond and Walker 1975 CdCl ₂	
102	Rat (ITRC)	21 d Gd 0-20 (W)		21			Saxena et al. 1986 Cd acetate	
103	Rat (Sprague-Dawley)	15 d Gd 6-20 (W)		0.63	4.7	(8% decreased fetal body weight)	Sorell and Graziano 1990 CdCl ₂	
104	Rat (Sprague-Dawley)	9 wk 1 x/d (GW)		1	10	(delayed ossification, decreased body weight)	Sutou et al. 1980 form not specified	
105	Mouse (QS/CH)	19 d Gd 1-19 (W)			2.4	(decreased fetal body weight; severe anemia)	Webster 1978 CdCl ₂	
CHRONIC EXPOSURE								
Systemic								
106	Human		Renal	0.0003 ^c F			Buchet et al. 1990; Jarup et al. 2000; Suwazono et al. 2006 form not specified	

Table 3-6 Levels of Significant Exposure to Cadmium - Oral

(continued)

Key to Figure ^a	Species (Strain)	Exposure/ Duration/ Frequency (Route)	System	NOAEL (mg/kg/day)	LOAEL		Reference Chemical Form	Comments
					Less Serious (mg/kg/day)	Serious (mg/kg/day)		
107	Human	NS lifetime (F)	Renal	0.0021			Nogawa et al. 1989 form not specified	
108	Human	>25 yr lifetime (environ)	Hemato	0.0078			Shiwen et al. 1990 Cd metal	
			Musc/skel	0.0078				
			Renal		0.0078	(increased excretion of low molecular weight proteins)		
109	Monkey (Rhesus)	9 yr (F)	Cardio	0.53 M	1.71 M	(increased blood pressure during the first 1.5 years)	Akahori et al. 1994 CdCl ₂	
110	Rat (Sprague- Dawley)	18 mo (W)	Renal			13 F (loss of glomerular polyanion charge barrier, proteinuria)	Bernard et al. 1992 CdCl ₂	
111	Rat (Wistar)	72 wk (F)	Renal	3.5	17.5	(8 to 9-fold increase in LDH and GST starting at 13 weeks)	Bomhard et al. 1984 CdCl ₂	

Table 3-6 Levels of Significant Exposure to Cadmium - Oral

(continued)

Key to Figure ^a	Species (Strain)	Exposure/Duration/Frequency (Route)	System	NOAEL (mg/kg/day)	LOAEL		Reference Chemical Form	Comments
					Less Serious (mg/kg/day)	Serious (mg/kg/day)		
112	Rat (Wistar)	daily 24 mo (W)	Musc/skel		0.08 F (decreases in bone mineral content and density of lumbar spine, altered bone turnover parameters, increases in deformed and fractured vertebral bodies)		Brzoska and Moniuszko-Jakoniuk 2004a, 2004b; Brzoska 2011 CdCl ₂	
113	Rat (Sprague-Dawley)	12 mo (W)	Hemato	0.79			Decker et al. 1958 CdCl ₂	
			Bd Wt	0.79				
114	Rat (Sprague-Dawley)	M: 92 wk F: 84 wk (W)	Cardio	4.01			Fingerle et al. 1982 CdCl ₂	
			Renal	0.8	1.51 (proximal tubule lesions)			
			Bd Wt	4.01				
115	Rat (Sprague-Dawley)	6, 12, or 18 mo (W)	Cardio	2.281 F			Mangler et al 1988 CdCl ₂	
			Hepatic	2.281 F				
			Renal		2.337 F (cloudy swelling of tubular cells)			
			Bd Wt	2.281 F				

Table 3-6 Levels of Significant Exposure to Cadmium - Oral

(continued)

Key to Figure ^a	Species (Strain)	Exposure/Duration/Frequency (Route)	System	NOAEL (mg/kg/day)	LOAEL		Reference Chemical Form	Comments
					Less Serious (mg/kg/day)	Serious (mg/kg/day)		
116	Rat (Wistar)	31 mo (W)	Musc/skel			3.6	(muscle atrophy)	Sato et al. 1978 CdCl ₂
			Bd Wt	3.6				
117	Rat (Wistar)	2 yr (W)	Renal	2.6 M				Shaikh et al. 1989 CdCl ₂
118	Rat (Wistar)	77 wk (F)	Bd Wt	3.5 M	7 M (10% decreased body weight)			Waalkes and Rehm 1992 CdCl ₂
119	Mouse (CF1)	18 months (F)	Musc/skel	0.65 F	6.5 F (loss of bone calcium in ovariectomized mice)			Bhattacharyya et al. 1988c
120	Mouse (CBA/H)	12 mo (W)	Hemato			57	(anemia and bone marrow hypoplasia)	Hays and Margaretten 1985 form not specified
			Renal	57				
			Bd Wt			57	(21% decreased terminal body weight)	
Neurological								
121	Rat (Wistar)	31 mo (W)				3.6	(peripheral neuropathy)	Sato et al. 1978 CdCl ₂

Table 3-6 Levels of Significant Exposure to Cadmium - Oral

(continued)

Key to Figure ^a	Species (Strain)	Exposure/ Duration/ Frequency (Route)	System	NOAEL (mg/kg/day)	LOAEL		Reference Chemical Form	Comments
					Less Serious (mg/kg/day)	Serious (mg/kg/day)		
Cancer								
122	Rat (Wistar)	77 wk (F)				3.5 M (CEL: increased rates of prostatic adenomas)	Waalkes and Rehm 1992 CdCl ₂	

a The number corresponds to entries in Figure 3-2.

b The intermediate-duration oral MRL of 0.0005 mg Cd/kg/day (0.5 ug Cd/kg/day) was calculated using a benchmark dose analysis. The BMDL1std of 0.05 mg Cd/kg/day was divided by an uncertainty factor of 100 (10 to account for extrapolation from animals to humans and 10 for human variability).

c The chronic-duration oral MRL of 0.0001 mg Cd/kg/day (0.1 ug Cd/kg/day) was calculated from the 95% lower confidence limit of the urinary cadmium level associated with a 10% increased risk of low molecular weight proteinuria (0.5 ug/g creatinine) estimated from a meta-analysis of select environmental exposure studies. An intake which would result in this urinary cadmium concentration was estimated using a modification of the Nordberg-Kjellström pharmacokinetic model (see Appendix A for details on the meta-analysis and extrapolation to dietary intake). This dose of 0.3 ug/kg/day was divided by an uncertainty factor of 3 for human variability.

Bd Wt = body weight; Cardio = cardiovascular; CEL = cancer effect level; d = day(s); Endocr = endocrine; (F) = feed; F = Female; (G) = gavage; Gastro = gastrointestinal; Gd = gestational day; (GO) = gavage in oil; GST = glutathione-S-transferase; (GW) = gavage in water; Hemato = hematological; Immuno/Lymphoret = immunological/lymphoreticular; LD50 = lethal dose, 50% kill; LDH = Lactate dehydrogenase; LOAEL = lowest-observed-adverse-effect level; M = male; mo = month(s); Musc/skel = musculoskeletal; NOAEL = no-observed-adverse-effect level; NS = not specified; ppd = post-parturition day; Resp = respiratory; SRBC = sheep red blood cells; (W) = drinking water; wk = week(s); x = time(s); yr = year(s)

Figure 3-2 Levels of Significant Exposure to Cadmium - Oral

Acute (≤14 days)

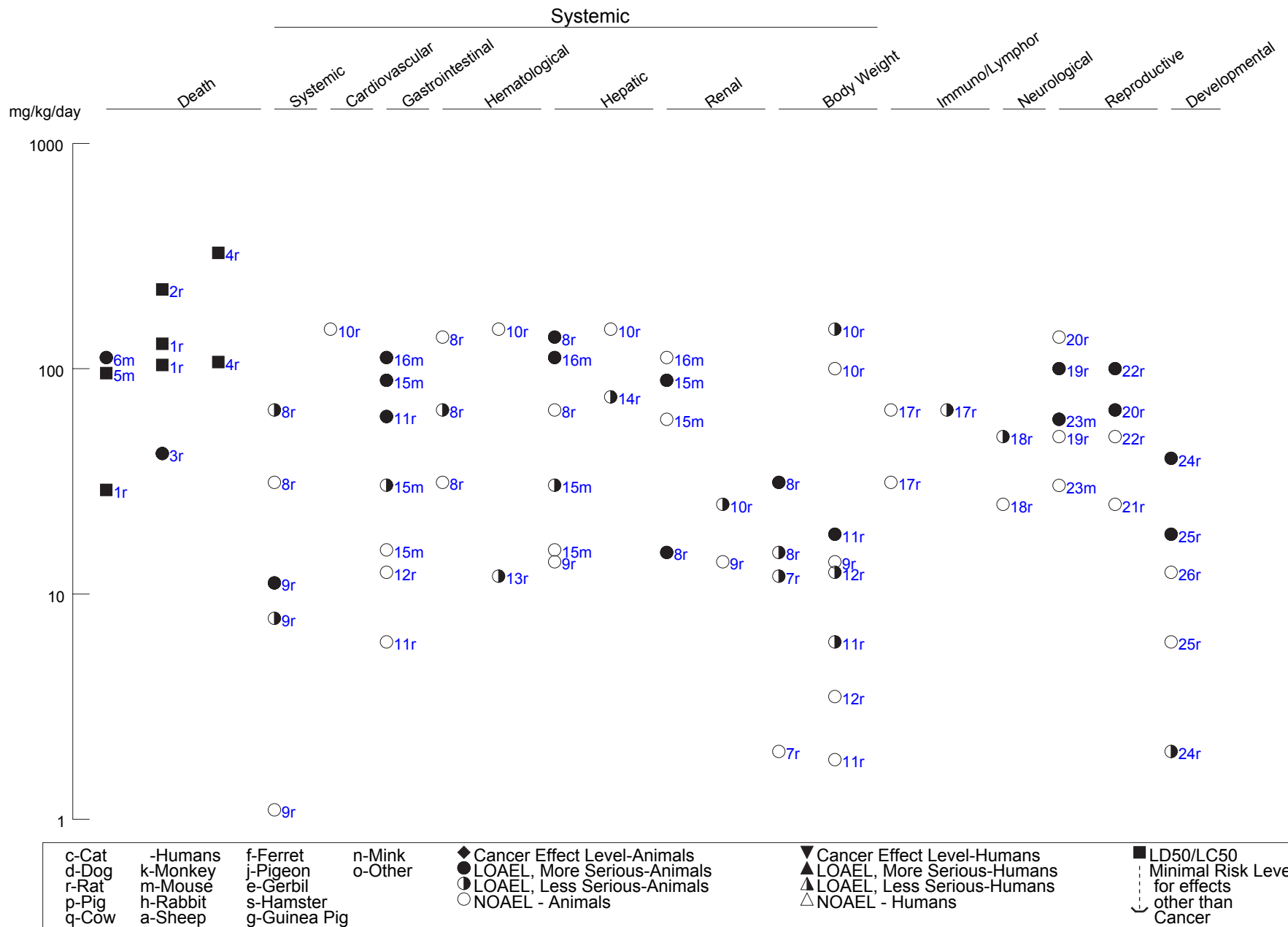

Figure 3-2 Levels of Significant Exposure to Cadmium - Oral (Continued)

Intermediate (15-364 days)

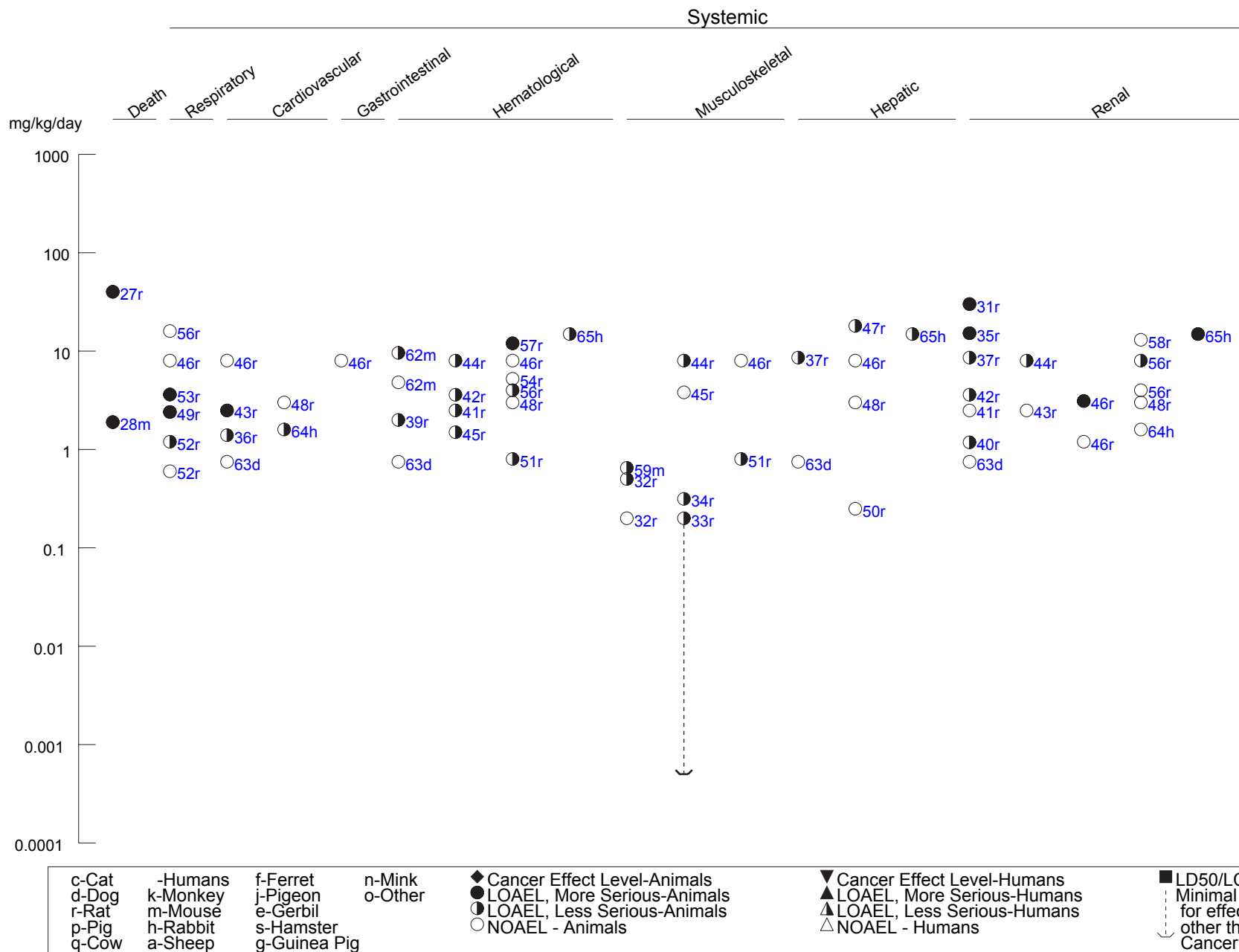

Figure 3-2 Levels of Significant Exposure to Cadmium - Oral (Continued)
Intermediate (15-364 days)

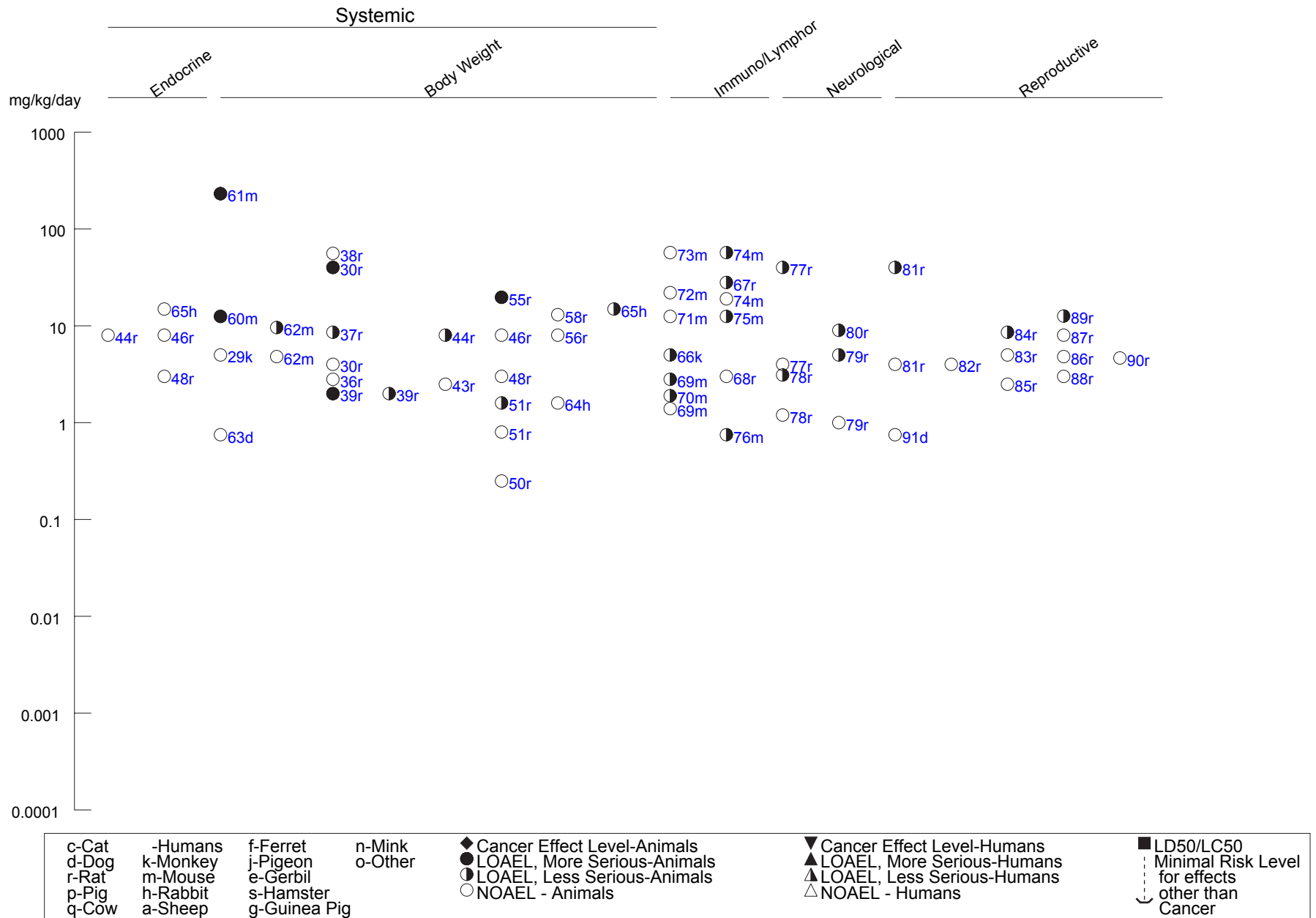

Figure 3-2 Levels of Significant Exposure to Cadmium - Oral (Continued)

Intermediate (15-364 days)

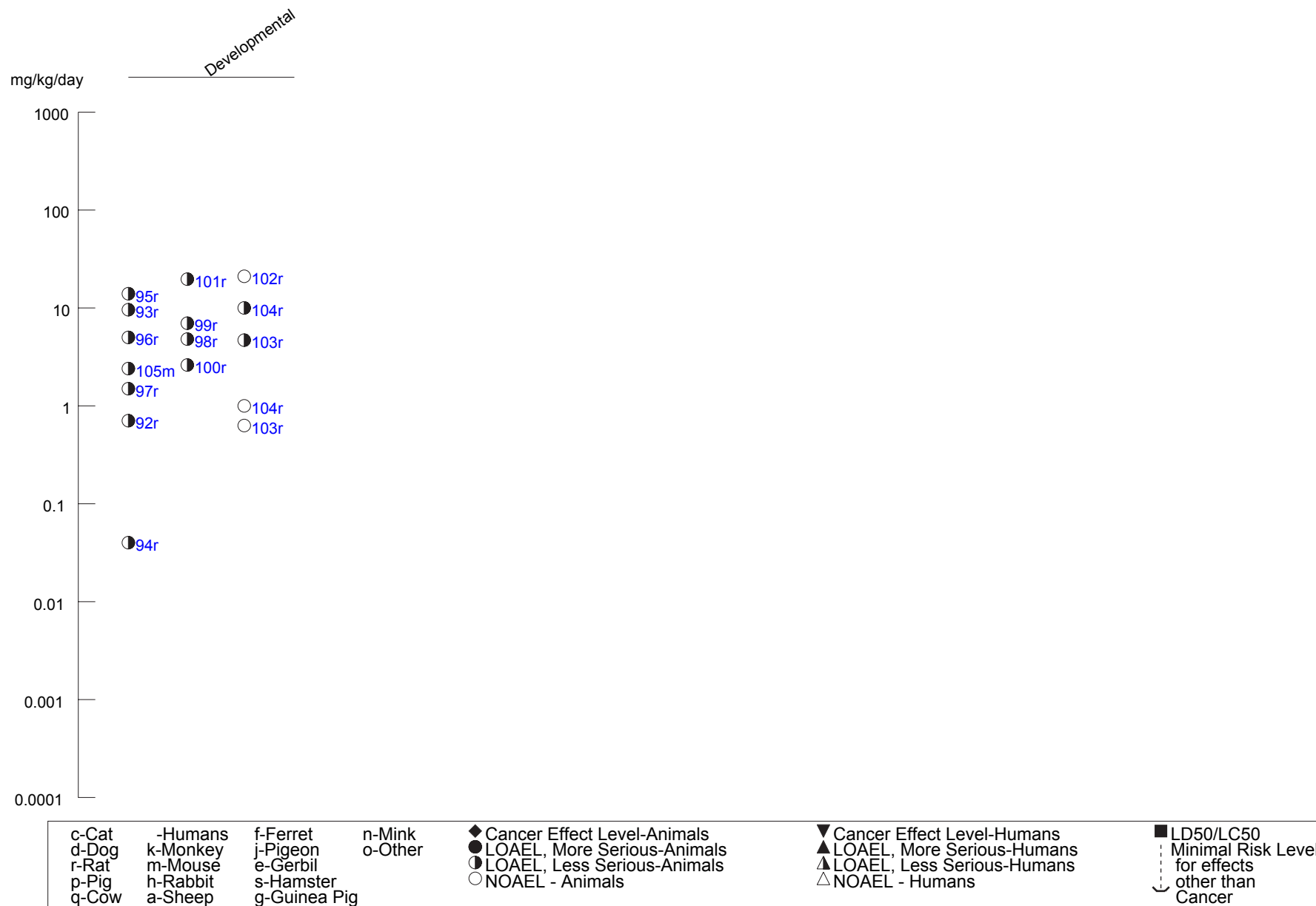
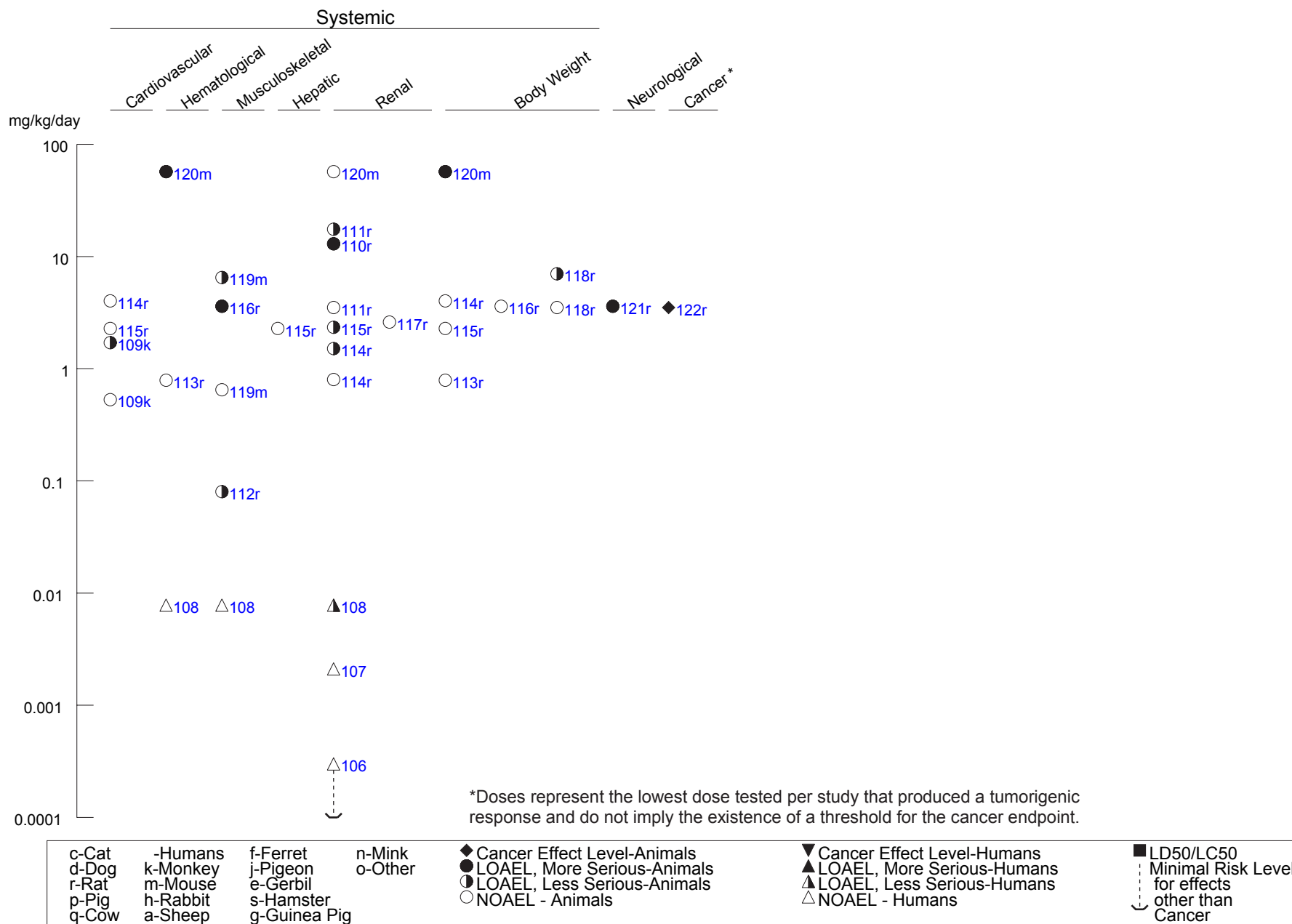

Figure 3-2 Levels of Significant Exposure to Cadmium - Oral (Continued)

Chronic (≥365 days)



3. HEALTH EFFECTS

Cardiovascular Effects. Studies regarding cardiovascular effects in humans after oral exposure to cadmium have primarily investigated relationships between blood pressure and biomarkers of cadmium exposure such as cadmium levels in blood, urine, or other tissues. Smoking is an important confounding factor, because of the higher blood, urine, and tissue cadmium levels of smokers (see Section 3.4) and the known cardiovascular toxicity of cigarette smoking. Case-control and cohort epidemiologic studies that adequately control for smoking have typically found no association between body cadmium levels (primarily reflecting dietary exposure) and hypertension (Beevers et al. 1980; Cummins et al. 1980; Ewers et al. 1985; Lazebnik et al. 1989; Satarug et al. 2005; Shiwen et al. 1990); however, some studies have found positive correlations (Geiger et al. 1989; Swaddiwuhipong et al. 2010; Tulley and Lehmann 1982) or negative correlations (Kagamimori et al. 1986; Staessen et al. 1984). Similar conflicting findings have been reported in studies analyzing death rates from cardiovascular disease among populations with dietary cadmium exposure (Inskip et al. 1982; Shigematsu 1984). Disorders of the cardiac conduction system, lower blood pressure, and decreased frequency of cardiac ischemic changes were found among elderly women with past high dietary exposure to cadmium (Kagamimori et al. 1986). Rhythmic disturbances, including ventricular fibrillation, were seen in an individual who had ingested 25 mg/kg cadmium as cadmium iodide (Wisniewska-Knypl et al. 1971).

Several studies conducting cross-sectional analysis on data from the National Health and Nutrition Examination Surveys (NHANES), investigated associations between blood and urine cadmium levels and cardiovascular effects (Agarwal et al. 2011; Eguogu et al. 2009; Everett and Frithsen 2008; Menke et al. 2009; Navas-Acien et al. 2005; Peters et al. 2010; Tellez-Plaza et al. 2008, 2010). Among adult participants in the NHANES 1988–1994 survey followed for mortality through 2000, the multivariable (including smoking)-adjusted hazard ratios of cardiovascular mortality associated with a 2-fold increase in creatinine-corrected urinary cadmium were 1.21 (95% CI of 1.07–1.36) in men and 0.93 (95% CI of 0.84–1.04) in women (Menke et al. 2009). The hazard ratios for coronary heart disease mortality were 1.36 (95% CI of 1.11–1.66) and 0.82 (95% CI of 0.76–0.89). Thus, the study suggests an association between elevated cadmium exposure and increased risk of cardiovascular mortality in men, but not in women. Urinary cadmium levels were found to be strongly associated with peripheral arterial disease (PAD, defined as blood pressure ankle brachial index <0.9 in at least one leg) in analysis conducted on 728 participants (at least 40 years of age) in the NHANES 1999–2000 study (Navas-Acien et al. 2005) and approximately 6,500 participants (≥ 40 years of age) in the NHANES 1999–2004 survey (Tellez-Plaza et al. 2010). Navas-Acien et al. (2005) reported that individuals with PAD had a 36% higher mean urine cadmium level than individuals without PAD; this study also found that individuals with PAD had 49%

3. HEALTH EFFECTS

higher urinary tungsten levels and urinary antimony levels exceeding 0.1 µg/L. In the Tellez-Plaza et al. (2010) analysis, the odds ratio for PAD comparing men with urinary cadmium levels in the highest quartile (≥ 0.69 µg/g creatinine) with the lowest quartile (< 0.20 µg/g creatinine) was 4.90 (95% CI of 1.55–15.54), after adjustment for age, race/ethnicity, education, smoking habits, and a variety of cardiovascular risk factors. In contrast, the odds ratio in women was 0.56 (95% CI of 0.18–1.71). When the women were divided by smoking habit, there was a positive progressive dose-response relationship and the odds ratio for PAD comparing the 80th with the 20th percentile for urinary cadmium was 1.46 (95% CI of 0.75–2.85) and for blood cadmium was 2.88 (95% CI of 1.10–7.50). Another study found a modest increase in systolic or diastolic blood pressure associated with increasing blood cadmium levels (geometric mean blood cadmium levels among all participants was 0.4 µg/L); no associations with blood pressure and urinary cadmium levels were found (Tellez-Plaza et al. 2008). The association between blood cadmium levels and blood pressure was stronger in participants who never smoked than in former smokers or current smokers. There were no associations between hypertension and cadmium levels in blood or urine. In the third study, analysis on 4,912 participants (45–79 years old) in the NHANES 1988–1994 survey found a significant association between urinary cadmium levels and myocardial infarction in women, but not men (Everett and Frithsen 2008). After adjusting for numerous risk factors including smoking, race, and family history, a significant increase in the risk of myocardial infarction was observed in women with urinary cadmium levels of ≥ 0.88 µg/g creatinine. Agarwal et al. (2011) found significantly higher blood cadmium levels among participants with cardiovascular and cerebrovascular disease in the NHANES 1999–2006 survey, as compared to participants without disease. The odds ratio of cardiovascular and cerebrovascular disease comparing the lowest blood cadmium quartile to the highest quartile was 1.44 (95% CI of 1.07–1.95) after adjusting for age, gender, race, education, hypertension, diabetes, hypercholesterolemia, BMI, c-reactive protein, and smoking. Peters et al. (2010) found that a 50% increase in blood or urinary cadmium levels resulted in a significant increase in the risk of stroke and congestive heart failure among participants in the NHANES survey. After adjusting for age, gender, race/ethnicity, education, BMI, poverty income ratio, alcohol consumption, smoking status, and disease (diabetes, hypertension, hypercholesterolemia, and chronic kidney disease), the odds ratios (95% CI) for stroke were 1.38 (1.14–1.67) and 1.10 (1.00–1.20) for 50% increases in blood and urinary cadmium levels, respectively; 50% increases in blood and urinary cadmium levels resulted in odds ratios (95% CI) for congestive heart failure of 1.48 (1.17–1.87) and 1.12 (1.04–1.21), respectively. A significant negative correlation between urinary cadmium levels and volume of oxygen consumed at sub-maximum activity (VO₂ max) among white males or Mexican American females (Egwuogu et al. 2009); however, no significant associations were found in black or Mexican American males and white and black females. Using a similar approach, Eum et al. (2008) and Lee et al. (2011) used data from the

3. HEALTH EFFECTS

Korean National Health and Nutrition Examination Survey (KNHANES) to assess the possible associations between cadmium exposure and cardiovascular effects. Eum et al. (2008) found a positive association (adjusted for age, gender, education, smoking status, alcohol intake, BMI, self-reported hypertension, family history of hypertension, and blood lead level) between blood cadmium levels and systolic, diastolic, and mean arterial blood pressure among adults. When comparing participants with the highest tertile of blood cadmium (1.87–5.52 $\mu\text{g/L}$) to those in the lowest tertile (0.18–1.28 $\mu\text{g/L}$), the multivariable adjusted odds ratio was 1.521 (95% CI of 1.129–2.049). In a similar analysis, Lee et al. (2011) divided the subjects by gender and found that an interquartile range increase (0.91 $\mu\text{g/L}$) in blood cadmium was associated with an elevated risk of hypertension (odds ratio of 1.4; 95% CI of 1.1–1.8) only in men. Lee et al. (2011) also found significant associations between an interquartile range increase in blood cadmium and the risk of ischemic heart disease in women (odds ratio of 2.28; 95% CI of 1.26–4.15). No significant associations between blood cadmium and risk of stroke were found.

In a study of children enrolled in the Treatment of Lead-Exposed Children trial, no significant associations between blood cadmium levels and blood pressure in 5 and 7 years olds following treatment for elevated blood lead levels (Cao et al. 2009).

A single gavage dose of 150 mg/kg cadmium in male Sprague-Dawley rats had no effect on blood pressure (Kotsonis and Klaassen 1977). Oral exposure of rats, rabbits, and monkeys to cadmium over intermediate and chronic durations has been found to increase blood pressure in some studies (Akahori et al. 1994; Boscolo and Carmignani 1986; Carmignani and Boscolo 1984; Kopp et al. 1982; Perry et al. 1989; Tomera and Harakal 1988), but not in others (Fingerle et al. 1982; Kotsonis and Klaassen 1978; Loeser and Lorke 1977a, 1977b; Mangler et al. 1988; Wills et al. 1981). In general, studies showing an effect on blood pressure have had control groups with lower blood pressure than studies showing no effect, and observed increases in blood pressure are generally small. At least in rats, the effect on blood pressure appears to be biphasic, reaching a maximum effect (an increase of 12–14 mm Hg in average systolic pressure) at intakes of 0.07 mg/kg/day, but decreasing to normal or even below normal at intakes 10–100 times higher (Kopp et al. 1982). Enlarged and arteriosclerotic hearts have been found in rats orally exposed to 0.35 mg Cd/kg/day for 3 years (Schroeder et al. 1965) or to 2.79 mg Cd/kg/day for 100 days (Wilson et al. 1941), but this effect is likely to be secondary to cadmium-induced anemia (Wilson et al. 1941). Histopathologic lesions of heart tissues (congestion, separation of muscle fibers) and decreased activity of antioxidant enzymes, but no increase in peroxidation, were found among rats given 2.5 mg/kg/day of cadmium in the diet for 7 weeks (Jamall et al. 1989).

3. HEALTH EFFECTS

Gastrointestinal Effects. Numerous human and animal studies indicate that oral exposure to cadmium in high concentrations causes severe irritation to the gastrointestinal epithelium (Andersen et al. 1988; Frant and Kleeman 1941). Common symptoms in humans following ingestion of food or beverages containing high concentrations of cadmium include nausea, vomiting, salivation, abdominal pain, cramps, and diarrhea (Baker and Hafner 1961; Buckler et al. 1986; Frant and Kleeman 1941; Nordberg et al. 1973; Shipman 1986; Wisniewska-Knypl et al. 1971). Although exact doses have not been measured, gastrointestinal symptoms have been caused in children by 16 mg/L cadmium in soft drinks (Nordberg et al. 1973) and 13 mg/L cadmium in popsicles (Frant and Kleeman 1941). Assuming an intake of 0.15 L (Nordberg et al. 1973) and a body weight of 35 kg, the emetic dose is 0.07 mg/kg. Although few studies have specifically examined gastrointestinal effects of longer-term cadmium exposure, no surveys of environmentally exposed populations have reported gastrointestinal symptoms (Morgan and Simms 1988; Roels et al. 1981a; Shigematsu 1984).

In rats and mice, histopathologic lesions (e.g., severe necrosis, hemorrhage, ulcers) in the gastrointestinal epithelium have been observed after high (>30 mg/kg/day) acute-duration oral cadmium exposure by gavage (Andersen et al. 1988; Basinger et al. 1988; Machemer and Lorke 1981), but not after lower levels (8 mg/kg/day in drinking water) for 24 weeks (Kotsonis and Klaassen 1978).

Hematological Effects. Oral cadmium exposure reduces gastrointestinal uptake of iron, which can result in anemia if dietary intake of iron is low. Anemia has been found in some instances among humans with chronic dietary exposure to cadmium (Kagamimori et al. 1986), but other studies have found no significant relationship between dietary cadmium exposure and anemia in humans (Roels et al. 1981a; Shiwen et al. 1990). Hypoproteinemia and hypoalbuminemia were reported in a male who ingested 25 mg/kg cadmium as cadmium iodide (Wisniewska-Knypl et al. 1971).

A number of studies have demonstrated that oral exposure to cadmium frequently produces anemia in laboratory animals, and that additional iron prevents anemia (Decker et al. 1958; Groten et al. 1990; Hays and Margaretten 1985; Itokawa et al. 1974; Kawamura et al. 1978; Kelman et al. 1978; Kozłowska et al. 1993; Ogoshi et al. 1989; Pleasants et al. 1992, 1993; Pond and Walker 1972; Sakata et al. 1988; Sorell and Graziano 1990; Stowe et al. 1972; Watanabe et al. 1986; Webster 1978; Wilson et al. 1941). Decreases in serum iron have also been reported (Prigge 1978a). Borzelleca et al. (1989) reported slight but statistically significant increases in hemoglobin, hematocrit, and erythrocytes in male rats at 65.6 mg/kg/day once a day for 10 days, but no change in females. Male Sprague-Dawley rats receiving a single gavage dose of 150 mg/kg cadmium showed no signs of anemia 14 days later (Kotsonis and

3. HEALTH EFFECTS

Klaassen 1977), but anemia was produced in male Wistar rats after 12 days of drinking-water exposure to 12 mg/kg/day (Sakata et al. 1988). Most intermediate-duration exposure studies in rats have shown evidence of anemia at doses of 2–14 mg/kg day (Decker et al. 1958; Groten et al. 1990; Itokawa et al. 1974; Kawamura et al. 1978; Pleasants et al. 1993; Pond and Walker 1972; Sakata et al. 1988; Wilson et al. 1941). However, some intermediate-duration studies have found no change in hemoglobin (Kotsonis and Klaassen 1978; Loeser and Lorke 1977a; Petering et al. 1979; Prigge 1978a) in rats treated at similar doses. Anemia has also been seen in intermediate-duration studies in mice (Webster 1978) and rabbits (Stowe et al. 1972), but not in dogs (Loeser and Lorke 1977b). The result in dogs may be due to the relatively low dose of cadmium (0.75 mg/kg/day) used in this study. Hematological effects following chronic-duration oral exposure to cadmium are less well characterized. In monkeys maintained on 4 mg/kg/day cadmium in food, pale feces, and clinical signs of anemia occurred after 90 weeks, but the anemia was associated with a decreased food intake rather than an increase in reticulocytes (Masaoka et al. 1994). Anemia was not present in rats exposed via drinking water for 12 months to the relatively low dose of 0.79 mg/kg/day (Decker et al. 1958). The number of erythroid progenitor cells in bone marrow is decreased in mice exposed to 57 mg/kg/day of cadmium in drinking water for 12 months (Hays and Margaretten 1985), but is increased in rats exposed to 12 mg/kg/day of cadmium in drinking water for up to 100 days (Sakata et al. 1988). Thus, the question remains open whether factors, in addition to reduced gastrointestinal absorption of iron, such as direct cytotoxicity to marrow or inhibition of heme synthesis may contribute to anemia.

Musculoskeletal Effects. Osteomalacia, osteoporosis, bone fractures, and decreased bone mineral density have been observed in several populations exposed to elevated levels of cadmium in the diet. Bone effects were first reported in residents in the Jinzu River Basin, a cadmium-contaminated area in Japan. The disease termed Itai-Itai or "ouch-ouch" disease most often affected women with several risk factors such as poor nutrition, multiparity, and postmenopausal status (Shigematsu 1984). The disease was characterized by multiple fractures of the long bones, osteomalacia, and osteoporosis in combination with proteinuria (Järup et al. 1998b; Nordberg et al. 1997). Other Japanese populations with dietary cadmium exposure have also been found to have elevated osteoporosis and osteomalacia in both men and women (Kido et al. 1989b). Kagamimori et al. (1986) evaluated elderly Japanese women with heavy cadmium exposure from ingesting polluted drinking water, rice, and fish during World Wars I and II; and continued low-grade cadmium exposure from agricultural produce. Of 56 cases of Itai-Itai disease, 26 were accompanied by osteomalacia and 26 were without osteomalacia. Another study found that the degree of loss of bone density is correlated with urinary excretion of β_2 -microglobulin, an index of renal injury (see Section 3.5.2) (Kido et al. 1990a). The bone effects observed in Itai-Itai disease and in other

3. HEALTH EFFECTS

studies of Japanese populations exposed to high levels of cadmium in rice are primarily due to kidney damage, which results from a progressive disturbance in renal metabolism of vitamin D to its biologically active form (Nogawa et al. 1987, 1990) and an increased urinary excretion of calcium (Buchet et al. 1990). These results suggest that bone changes may be secondary to disruption in kidney of vitamin D metabolism and resulting imbalances in calcium absorption and excretion. A recent study of women living in the Jinzu River basin found that bone turnover, particularly bone formation, was influenced by renal tubular function (Aoshima et al. 2003). However, it is possible that some bone effects are not mediated via the kidney.

Bone effects have also been observed in communities outside of Japan and in populations exposed to low levels of cadmium. In a study of Swedish women environmentally exposed to cadmium, a significant negative relationship between urinary cadmium levels and bone mineral density was observed (Åkesson et al. 2005); the mean urinary cadmium level of the population was 0.52 µg/L. In Swedish residents living in an area with known cadmium pollution from battery manufacturing facilities, significant associations were noted between blood cadmium levels and bone mineral density and between urinary cadmium levels and risk of fractures and osteoporosis. There were significant decreases in bone mineral density in environmentally exposed subjects older than 60 years of age with blood cadmium levels of ≥ 0.56 µg/L (Alfvén et al. 2002a). Increases in the risk of bone fractures were observed in subjects (approximately 10% of all subjects examined had environmental and occupational exposure to cadmium) older than 50 years of age with urinary cadmium levels >2 µg/g creatinine; no significant associations were found in subjects under 50 years of age (Alfvén et al. 2004). Another study of this population found significant increases in the risk of osteoporosis among men >60 years of age with urinary cadmium levels ≥ 5 µg/g creatinine; however, an increased risk of osteoporosis was not observed in women (Alfvén et al. 2000). A Belgian study in which residents living near zinc smelters found a 2-fold increase in cadmium exposure (as assessed via urinary cadmium levels) was associated with a decrease in proximal and distal forearm bone density of approximately 0.1 g/cm² among postmenopausal women (Staessen et al. 1999). For women with urinary cadmium levels >1 µg/day, the incidence of bone fracture was 13.5 per 1,000 person-years. Another study of a subset of the women living near a zinc smelters (Schutte et al. 2008) provides suggestive evidence that cadmium has a direct osteotoxic effect. Significant associations between urinary cadmium levels and the levels of two pyridinium crosslinks of collagen (urinary levels of hydroxylsypyridinoline and lysypyridinoline), proximal forearm bone mineral density, and serum parathyroid hormone levels were found. In almost all of the examined women, urinary levels of retinol binding protein were below the cut-off level of 338 µg/day, suggesting no cadmium-induced effect on renal tubular function. Several biomarkers of bone damage were examined in a subsequent follow-up

3. HEALTH EFFECTS

study of some of the women (Schutte et al. 2008) only 1 of the 294 women examined had evidence of renal dysfunction (increased retinol binding protein). Significant associations between urinary cadmium excretion and two biomarkers of bone resorption (urinary hydroxylysylpyridinoline and lysylpyridinoline) were found. Although significant associations between urinary cadmium levels and biomarkers of renal dysfunction were observed in Polish adults living in a cadmium-polluted area, the only association between urinary cadmium and bone biomarkers was a significant decrease in bone mineral density among males with urinary cadmium levels of $\geq 2 \mu\text{g/g}$ creatinine (Trzcinka-Ochocka et al. 2010). Similar results have been observed in several studies of residents living in areas of China with moderate or high cadmium pollution levels (Jin et al. 2004b; Nordberg et al. 2002; Wang et al. 2003; Zhu et al. 2004). There were significant increases in the prevalence of low forearm bone mineral density in postmenopausal women with urinary cadmium levels $>20 \mu\text{g/g}$ creatinine and in men, premenopausal women, and postmenopausal women with blood cadmium levels $>20 \mu\text{g/L}$ (Nordberg et al. 2002). An increase in bone fractures was observed in males and females over the age of 40 years living in the area of high cadmium exposure (mean urinary cadmium levels in the area were 9.20 and 12.86 $\mu\text{g/g}$ creatinine in the males and females, respectively) (Wang et al. 2003). A significant dose-response relationship between urinary cadmium levels and the prevalence of osteoporosis was observed (Jin et al. 2004b; Wang et al. 2003; Zhu et al. 2004); the Jin et al. (2004b) study found that 23 of the 31 subjects with osteoporosis also exhibited signs of renal dysfunction. A subsequent study by this group examined 316 male and female residents living in areas with moderate or heavy cadmium pollution 10 years after the source of rice was switched to commercially available rice from nonpolluted areas (Chen et al. 2009). As in the earlier studies, significant decreases in forearm bone mineral density were observed in the women living in the moderately polluted area and in the men and women living in the heavily polluted areas. When the subjects were divided by age, decreases in bone mineral density were observed in women 60–69 or ≥ 70 years old in both cadmium polluted areas and in men ≥ 70 years living in the heavily polluted area. A significantly higher prevalence of osteoporosis was also observed in women living in the polluted areas and the prevalence increased with increasing urinary cadmium levels. In another study of this population, Chen et al. (2011) found a higher prevalence of osteoporosis (assessed in 2006) among women with renal dysfunction (urinary albumin $>15 \text{ mg/g}$ creatinine and urinary NAG $\geq 12 \text{ IU/g}$ creatinine; renal biomarkers assessed in 1998) or tubular damage (urinary NAG $\geq 12 \text{ IU/g}$ creatinine); no significant association was found for glomerular damage (urinary albumin $\geq 15 \text{ mg/g}$ creatinine). Significantly lower bone mineral density levels were also found in women with tubular damage, as compared to those without tubular damage. In men, no significant associations between the prevalence of osteoporosis or bone mineral density and alterations in renal biomarkers were found. Chen et al. (2011) also compared the change in bone mineral damage from 1998 to 2006 in subjects with and without evidence of kidney

3. HEALTH EFFECTS

damage and found a significantly greater decrease in bone mineral density among women with tubular damage. In a study of adults living near an industrial complex in Korea, significant associations between high urinary cadmium levels (≥ 1.0 $\mu\text{g/g}$ creatinine) and osteopenia were observed in males and females (Shin et al. 2011). Bone mineral density was also negatively associated with urinary cadmium levels.

In a substudy of a population-based health survey in Sweden (Engström et al. 2009), a significantly lower bone mineral density was observed in postmenopausal women with elevated urinary cadmium levels (median of 1.1 $\mu\text{g/g}$ creatinine, 5–95th percentile of 0.69–1.7 $\mu\text{g/g}$ creatinine) as compared to women with low urinary cadmium levels (median of 0.36 $\mu\text{g/g}$ creatinine; 5–95th percentile of 0.18–0.73 $\mu\text{g/g}$ creatinine). Significant decreases in serum parathyroid hormone levels and increases in urinary deoxypyridinoline levels (indicative of increased bone resorption) were also found in the high urinary cadmium group; however, there were no significant alterations in serum 1,25-dihydroxyvitamin D levels. Significant elevations in biomarkers of renal dysfunction (urinary NAG and pHC and estimated glomerular filtration rate) were also in the high urinary cadmium group. In the U.S. general population (using data collected during NHANES III, 1988–1994), a significant association was found between urinary cadmium levels and osteopenia and osteoporosis among adults with urinary cadmium levels of >1 $\mu\text{g/g}$ creatinine (Wu et al. 2010). Using the same NHANES data set, Gallagher et al. (2008) found a 43% increased risk of osteoporosis (hip bone mineral density defined) (odds ratio of 1.43; 95% CI of 1.02–2.00) among women ≥ 50 years of age with urinary cadmium levels of 0.50–1.00 $\mu\text{g/g}$ creatinine, as compared to women with urinary cadmium levels of <0.50 $\mu\text{g/g}$ creatinine.

Using data collected during NHANES III (1988–1994), Arora et al. (2008, 2008) examined the possible association between urinary cadmium levels and dental health in children and adults. In children aged 6–12 years, a significant association (adjusted for age, gender, ethnicity, education level, poverty status, log-transformed blood lead, log-transformed serum cotinine, and dietary sucrose intake) between urinary cadmium levels and dental caries in deciduous teeth among children with low external tobacco smoke exposure; no significant associations were found in permanent teeth (Arora et al. 2008). A significant association (after adjustment for gender, age, education level of household head, race/ethnicity, household poverty status, time since last visit to dentist, missing teeth, serum cotinine, smoking habits, exposure to external tobacco smoke, blood lead, diabetes, renal dysfunction, and bone mineral density) between urinary cadmium and periodontal disease (presence of attachment loss of at least 4 mm in $>10\%$ of sites examined) in adults (≥ 18 years of age) (Arora et al. 2009). A logistic regression model predicted a 56% increase in the prevalence of periodontal disease associated with a 3-fold increase in urinary cadmium levels (0.18–0.63 $\mu\text{g/g}$ creatinine).

3. HEALTH EFFECTS

A number of animal studies confirm the findings of the epidemiology data suggesting that the bone is a sensitive target of cadmium toxicity. Decreases in bone mineralization and bone mineral density have been observed in female rats exposed to ≥ 0.2 mg Cd/kg/day in the lumbar spine, femur, and tibia (Brzóška et al. 2004b, 2005a, 2005b, 2005c) and in male rats exposed to ≥ 0.5 mg Cd/kg/day (Brzóška and Moniuszko-Jakoniuk 2005a, 2005b; Brzóška et al. 2010; Yokota and Tonami 2008) for an intermediate duration and in female rats chronically exposed to 0.08 mg Cd/kg/day (Brzóška 2012; Brzóška and Moniuszko-Jakoniuk 2004a, 2004b). In the series of studies conducted by Brzóška and associates, the occurrence of osteopenia and osteoporosis was evaluated using data for bone mineral density of the cadmium-exposed rats, control rats, and healthy adult rats. Osteopenia was observed in male rats exposed to 0.5 mg Cd/kg/day for 12 months (Brzóška and Moniuszko-Jakoniuk 2005a, 2005b) and in female rats exposed to 0.08 mg Cd/kg/day for 12 or 18 months (Brzóška and Moniuszko-Jakoniuk 2004a, 2004b); osteoporosis was observed in male rats exposed to 4 mg Cd/kg/day for 12 months (Brzóška and Moniuszko-Jakoniuk 2005a, 2005b) and in female rats exposed to 0.08 mg Cd/kg/day for 24 months (Brzóška and Moniuszko-Jakoniuk 2004a, 2004b).

The decreases in bone mineralization resulted in altered mechanical properties (e.g., stiffness, load, displacement at load) of the vertebral body, femur, and tibia and increases in the number of animals with deformed or fractured lumbar spinal bone in female rats exposed to ≥ 0.2 mg Cd/kg/day for an intermediate duration (Brzóška and Moniuszko-Jakoniuk 2005d; Brzóška et al. 2004b, 2005b, 2005a, 2005c, 2010; Ogoshi et al. 1989); increases in lumbar spine deformities were also observed in male rats exposed to 0.5 mg Cd/kg/day for 12 months (Brzóška and Moniuszko-Jakoniuk 2005a, 2005b) and in female rats exposed to 0.08 mg Cd/kg/day for 24 months (Brzóška 2012; Brzóška and Moniuszko-Jakoniuk 2004a, 2004b).

The studies by Brzóška and associates reported significant alterations in biochemical markers of bone turnover. During the first 6 months of a 1-year study, significant decreases in osteocalcin concentrations were observed in female rats exposed to ≥ 0.2 mg Cd/kg/day; no alterations were observed during the last 6 months of the study (Brzóška and Moniuszko-Jakoniuk 2005d). Observed changes in alkaline phosphatase levels included decreases in total serum levels in the 4 mg Cd/kg/day group after 6, 9, or 12 months of exposure, decreases in trabecular bone levels at ≥ 0.2 mg Cd/kg/day after 3, 6, or 9 months of exposure and at 0.5 mg Cd/kg/day at 12 months, decreases in cortical bone levels at 4 mg Cd/kg/day after 3 months of exposure, and increases in trabecular bone and cortical bone alkaline phosphatase at 4 mg Cd/kg/day after 12 months (Brzóška and Moniuszko-Jakoniuk 2005d). Serum C-terminal

3. HEALTH EFFECTS

telopeptides of type I collagen concentration (CTX) was significantly decreased after 3 or 6 months of exposure or increased after 9 or 12 months in rats exposed to ≥ 0.2 mg Cd/kg/day (Brzóška and Moniuszko-Jakoniuk 2005d). As noted by Brzóška and Moniuszko-Jakoniuk (2005d), these alterations in bone turnover markers indicate that cadmium exposure at the stage of intensive skeletal development leads to low bone turnover and induces high bone turnover due to enhanced resorption at the stage of consolidation of bone mass and at skeletal maturity.

Decreased calcium content of bone and increased urinary calcium excretion are common findings in intermediate- and chronic-duration studies in the 0.2–8 mg Cd/kg/day range (Brzóška and Moniuszko-Jakoniuk 2005d; Kawamura et al. 1978; Nogawa et al. 1981b; Pleasants et al. 1992; Watanabe et al. 1986). In contrast, Kotsonis and Klaassen (1978) reported no change in bone calcification after a 24-week exposure via drinking water at 8 mg/kg/day, and Kelman et al. (1978) reported no significant change in stable or radiolabeled calcium in any maternal rat tissues from a 3.8 mg/kg/day in drinking water for 22 days during gestation.

Gender, age, and nutritional state appear to influence cadmium toxicity on bone. In the series of experiments conducted by Brzóška and associates, alterations in bone mineral density and the mechanical strength of the lumbar spine and femur were observed in female rats exposed to ≥ 0.2 mg Cd/kg/day and in male rats at 0.5 mg Cd/kg/day (Brzóška and Moniuszko-Jakoniuk 2005a, 2005b, 2005d; Brzoska et al. 2005a, 2005c); no adverse bone effects were observed in males exposed to 0.2 mg Cd/kg/day. In the Ogoshi et al. (1989) study, decreases in the mechanical strength of the femur bone were observed in young rats (21 days of age) exposed to 0.8 mg Cd/kg/day for 4 weeks; however, no alterations in bone strength were observed in adult (24 weeks of age) or elderly (1.5 years of age) rats exposed to cadmium doses as high as 25.6 mg Cd/kg/day for 4 weeks. Adverse effects on bone are exacerbated by a calcium-deficient diet (Itokawa et al. 1974; Kimura et al. 1974; Larsson and Piscator 1971; Wang and Bhattacharyya 1993; Wang et al. 1994), by ovariectomy (Bhattacharyya et al. 1988c), or by multiple rounds of gestation and lactation (Bhattacharyya et al. 1988b).

Hepatic Effects. Liver damage is not usually associated with oral cadmium exposure, except at very high levels of exposure. In humans, a fatal dose of cadmium can cause pronounced liver damage (Buckler et al. 1986; Wisniewska-Knypl et al. 1971). Nishino et al. (1988) reported increased serum concentrations of the urea-cycle amino acids among individuals exposed to cadmium in the diet, and that these levels reflected liver as well as kidney damage. No cadmium-related alterations in liver biomarkers including serum levels of alkaline phosphatase, alanine aminotransferase, aspartate aminotransferase,

3. HEALTH EFFECTS

lactate dehydrogenase, and γ -glutamyl transpeptidase were observed in women living in cadmium nonpolluted areas in Japan (Ikeda et al. 1997, 2000). No other studies were located regarding hepatic effects in humans after oral exposure to cadmium.

Hepatic effects have been found in rats, mice, and rabbits after oral cadmium exposure. Acute exposure via gavage at doses of 30–138 mg/kg/day causes liver necrosis in most studies (Andersen et al. 1988; Basinger et al. 1988; Borzelleca et al. 1989; Shimizu and Morita 1990), although histopathologic evidence of liver damage was not seen in one study at a gavage dose of 150 mg/kg (Kotsonis and Klaassen 1977). Exposure of rats for 10 days to drinking water containing 13.9 mg Cd/kg/day was without effect on the liver (Borzelleca et al. 1989). Depletion of liver glutathione by fasting increases the liver necrosis following acute oral exposure to cadmium in rats (Shimizu and Morita 1990).

In a 10-week study, male Rhesus monkeys exposed to 4 mg/kg/day cadmium chloride via gavage, had a significant decrease in glutathione peroxidase in liver, kidney, heart, and lung in the following order: liver>kidney>heart>lung; a significant decrease in glutathione *S*-transferase (GST) activity towards 1-chloro-2,4-dinitrobenzene in all four organs in the following order: liver>lung>kidney>heart; and a significant increase in GST activity towards ethacrynic acid in all four organs in the following order: heart>lung>kidney>liver (Sidhu et al. 1993). Intermediate-duration exposure causes histopathologic changes in the liver (e.g., necrosis of central lobules, focal hepatic fibrosis, biliary hyperplasia) at doses of 1.6–15 mg/kg/day (Cha 1987; Gill et al. 1989b; Miller et al. 1974a; Renugadevi and Prabu 2010; Schroeder et al. 1965; Stowe et al. 1972; Wilson et al. 1941), and metabolic alterations (e.g., decreased cytochrome c oxidase activity in mitochondria, increased ALT and AST activities) at doses of 0.05–10 mg/kg/day (Groten et al. 1990; Muller and Stacey 1988; Muller et al. 1988; Renugadevi and Prabu 2010; Sporn et al. 1970; Steibert et al. 1984; Tewari et al. 1986b). Decreased relative liver weight to body weight has also been reported in male rats fed 5.95 mg/kg/day for 6 weeks (Kozłowska et al. 1993).

Hypertriglyceridemia was observed in male rats exposed to 18 mg Cd/kg/day as cadmium chloride in the drinking water for 8 weeks (Larregle et al. 2008); the increase in plasma triglycerides was likely due to a decrease in lipoprotein lipase activity (key enzyme in triglyceride hydrolysis). A significant increase in liver triglyceride level was also observed; this increase was attributed to increased triglyceride synthesis.

Other intermediate and chronic duration studies have not found liver effects in animals following oral exposure. These studies include a daily gavage exposure of 14 mg/kg/day for 6 weeks in rats (Hopf et al. 1990), a 3-month exposure to cadmium in food at 3 mg/kg/day in rats (Loeser and Lorke 1977a), a

3. HEALTH EFFECTS

24-week exposure to cadmium in water at 8 mg/kg/day in rats (Kotsonis and Klaassen 1978), and a 3-month exposure in food at 0.75 mg/kg/day in dogs (Loeser and Lorke 1977b). Kopp et al. (1982) report no hepatic effects from a chronic exposure of 18 months to cadmium in water at 0.65 mg/kg/day in rats.

Renal Effects. Numerous studies indicate that the kidney is the primary target organ of cadmium toxicity following extended oral exposure, with effects similar to those seen following inhalation exposure (see Section 3.2.1.2). Most of the data involves chronic exposure to cadmium; two case reports involving acute exposure to large doses of cadmium also found kidney effects. In two fatal cases of oral cadmium poisoning, anuria was present in one individual who ingested 25 mg/kg cadmium as cadmium iodide. Damage to the kidneys was reported at autopsy, but was not further specified (Wisniewska-Knypl et al. 1971). The kidneys were reported as normal at autopsy in an individual who died 2 days after ingesting 1,840 mg/kg cadmium (Buckler et al. 1986).

Several studies have found associations between increased mortality and renal dysfunction in residents living in cadmium polluted areas. Significant increases in SMRs were found in residents living in cadmium polluted areas of Japan with elevated levels of biomarkers of renal dysfunction (Arisawa et al. 2001, 2007b; Iwata et al. 1991a, 1991b; Matsuda et al. 2002; Nakagawa et al. 1993; Nishijo et al. 1995, 2004a, 2006). Among the studies that examined cause of death, significant increases in deaths from renal diseases were found in the residents that were categorized as biomarker-positive (urinary levels of the renal biomarker was higher than the cut-off value); the cut-off values used were β 2-microglobulin $\geq 1,000$ $\mu\text{g/g}$ creatinine (Arisawa et al. 2001, 2007b; Iwata et al. 1991a, 1991b; Nakagawa et al. 1993; Nishijo et al. 2004a, 2006) or retinol binding protein ≥ 4 mg/L (Nishijo et al. 1995). Other studies have found that mortality increased in proportion to the renal biomarker level (β 2-microglobulin, protein, or glucose) (Iwata et al. 1991a, 1991b; Matsuda et al. 2002; Nakagawa et al. 1993; Nishijo et al. 2004a, 2006). Increases in mortality from renal diseases have also been observed among populations living in cadmium polluted areas of Belgium (Lauwerys and De Wals 1981) and England (Inskip et al. 1982); however, statistical analysis was not reported in the Belgium study and the increase in renal disease was not statistically significant in the other study. In a nationwide study in Japan, no significant associations between the levels of cadmium in brown rice and deaths from all causes or age-adjusted renal insufficiency mortality rate were found (Koizumi et al. 2010).

Elevated levels of several biomarkers of renal dysfunction and/or associations between cadmium burden and these biomarkers have been found in studies of populations living in cadmium nonpolluted areas of Japan (Ezaki et al. 2003; Ikeda et al. 1999; Suwazono et al. 2000; Oo et al. 2000; Uno et al. 2005;

3. HEALTH EFFECTS

Yamanaka et al. 1998), South Korea (Hwangbo et al. 2011), Belgium (Buchet et al. 1990; Roels et al. 1981a), and the United States (Ferraro et al. 2010; Noonan et al. 2002) and in populations living in cadmium polluted areas of China (Cai et al. 1990, 1992, 1998; Jin et al. 2002, 2004a, 2004c; Nordberg et al. 1997; Wu et al. 2001), Japan (Cai et al. 2001; Hayano et al. 1996; Horiguchi et al. 2010; Ishizaki et al. 1989; Izuno et al. 2000; Kawada et al. 1992; Kido and Nogawa 1993; Kobayashi et al. 2002b, 2009b; Monzawa et al. 1998; Nakadaira and Nishi 2003; Nakashima et al. 1997; Nogawa et al. 1989; Osawa et al. 2001; Watanabe et al. 2002), Thailand (Honda et al. 2010; Teeyakasem et al. 2007), Sri Lanka (Bandara et al. 2010), Sweden (Järup et al. 2000; Olsson et al. 2002), and Poland (Trzcinka-Ochocka et al. 2004). Most of these studies did not estimate cadmium intake; rather, exposure was characterized based on the levels of cadmium in rice, blood, or urine. The oral route is assumed to be the primary route of exposure, although the inhalation route, particularly in smokers, may have contributed to the overall cadmium body burden. The epidemiology data are summarized in [Table 3-7](#) and brief discussions of the better designed studies providing valuable dose-response data follows.

Buchet et al. (1990) examined 1,699 non-occupationally exposed males and females (aged 20–80 years) living in Belgium. Urinary cadmium levels significantly correlated with urinary β 2-microglobulin, retinol binding protein, NAG, amino acid, and calcium levels; the partial r^2 values were 0.0036, 0.0210, 0.0684, 0.0160, and 0.0168, respectively. The probability that individuals would have abnormal values for the renal biomarkers (defined as $>95^{\text{th}}$ percentile for subjects without diabetes or urinary tract diseases and who did not regularly take analgesics) was estimated using logistic regression models with adjustments for age, gender, smoking, disease, and use of analgesics. It was estimated that $>10\%$ of β 2-microglobulin, retinol binding protein, amino acid, and calcium values would be abnormal when 24-hour urinary cadmium levels were >3.05 , 2.87 , 2.74 , 4.29 , or $1.92 \mu\text{g}/24$ hour, respectively.

Järup et al. (2000) examined 1,021 individuals living near a nickel-cadmium battery plant in Sweden for at least 5 years ($n=799$) or employed as battery workers ($n=222$). The mean urinary cadmium levels were 0.81 and $0.65 \mu\text{g}/\text{g}$ creatinine in males and females, respectively. Urinary cadmium levels were significantly associated with urinary human complex-forming glycoprotein (pHC; also referred to as α 1-microglobulin) levels, after adjustment for age. The relationship remained statistically significant after removal of the cadmium workers from the analysis. The prevalence of abnormal pHC values (defined as exceeding the 95^{th} percentile in a Swedish reference population; >7.1 and $5.3 \text{ mg}/\text{g}$ creatinine for males and females, respectively) was estimated to increase by 10% at urinary cadmium levels of $1 \mu\text{g}/\text{g}$ creatinine. The European Chemicals Bureau (2007) recalculated the probability of HC proteinuria (using the raw data from Järup and associates) to account for the differences in age of the reference

3. HEALTH EFFECTS

Table 3-7. Summary of Human Studies Examining Renal Effects

Population studied	Mean urinary cadmium level	Effect biomarker	Results	Reference
General population (Japan) 10,753 females; 35–60 years old	1.26 µg/g creat.	β2M pHC	Significant correlation between urinary cadmium and effect biomarkers; however, no significant relationship was established when age was factored into analysis.	Ezaki et al. 2003
General population (Japan) 470 nonsmoking females	2.1 µg/g creat.	β2M pHC	Significant correlation between urinary cadmium (not corrected for creat.) and pHC and β2M.	Ikeda et al. 1999
General population (Japan) 1,105 males, 1,648 females; >50 years old	1.8 µg/g creat. (M) 2.4 µg/g creat. (F)	β2M Total protein NAG	Significant correlation between urinary cadmium and protein and β2M. Dose-response relationship between urinary cadmium and prevalence of abnormal effect biomarker levels.	Suwazono et al. 2000
General population (Japan) 568 males, 742 females; ≥50 years old	2.2–3.4 µg/L (M) 2.8–3.9 µg/L (F)	total protein NAG β2M	Significant correlation (with age adjustment) between urinary cadmium and effect biomarkers.	Oo et al. 2000
General population (Japan) 558 males, 743 females; ≥50 years old	1.3 µg/g creat. (M) 1.3 µg/g creat. (F)	β2M total protein NAG	Significant correlation between urinary cadmium and effect biomarkers (NAG was only significant in females). Dose-response relationship between urinary cadmium and prevalence of abnormal effect biomarker levels.	Yamanaka et al. 1998
General population (Japan) 410 males, 418 females; 40–59 years old	0.8 µg/g creat. (M) 1.8 µg/g creat. (F) (median levels)	β2M protein NAG	Significant associations between urinary cadmium and effect biomarkers (protein only significant in males). Dose-response relationship between urinary cadmium and prevalence of abnormal effect biomarker levels.	Uno et al. 2005
General population (South Korea) 955 males, 954 females; ≥20 years of age		Glomerular filtration rate	Significant association between elevated blood cadmium levels and decreased glomerular filtration rate in females only.	Hwangbo et al. 2011

3. HEALTH EFFECTS

Table 3-7. Summary of Human Studies Examining Renal Effects

Population studied	Mean urinary cadmium level	Effect biomarker	Results	Reference
General population (Belgium) 175 females; mean age 81.1–82.3 years old	0.040–0.093 µg/hour	β2M protein amino acids albumin	Dose-response relationship between urinary cadmium and urinary protein and amino acids; significant relationship with β2M and albumin only in the two areas with highest urinary cadmium levels.	Roels et al. 1981a
General population (Belgium) 1,699 males, females; 20–80 years old		β2M protein NAG amino acids calcium	Significant correlation between urinary cadmium and effect biomarkers. Dose-response relationship between urinary cadmium and prevalence of abnormal effect biomarker levels.	Buchet et al. 1990
General population (United States) 88 males, 71 females; 6–17 years old; 71 males, 80 females; ≥18 years old	0.07 µg/g creat. (M, child) 0.08 µg/g creat. (F, child) 0.24 µg/g creat. (M, adult) 0.23 µg/g creat. (F, adult)	β2M NAG AAP albumin	No significant associations (after correction for age, sex) between urinary cadmium and effect biomarkers in children. Significant association (after age and gender adjustment) between urinary cadmium and NAG and AAP in adults. Dose-response relationship between urinary cadmium and NAG and AAP.	Noonan et al. 2002
General population (United States) 2,644 males, 2,782 females ≥20 years old (data from NHANES 1999–2006)	0.29 µg/g creat.	albumin	Significant association (after age, gender, race/ethnicity, and BMI adjustment) between urinary cadmium >1 µg/g creatinine and urinary albumin to creatinine ratio of >20 mg/g (males) or 30 mg/g (females).	Ferraro et al. 2010
Residents in cadmium-polluted area (China) 433 males and females	11.27 µg/g creat.	β2M NAG	Significantly higher effect biomarkers levels.	Cai et al. 1990, 1992
Residents in cadmium-polluted area (China) 219 males and females		β2M	Significant dose-response relationship between urinary cadmium, blood cadmium, and cumulative Cd intake and β2M; prevalence of abnormal values.	Cai et al. 1998

3. HEALTH EFFECTS

Table 3-7. Summary of Human Studies Examining Renal Effects

Population studied	Mean urinary cadmium level	Effect biomarker	Results	Reference
Residents in cadmium-polluted area (China) 118 males, 170 females in high exposure group 80 males, 158 females in moderate exposure group	High: 11.18 µg/g creat. Mod.: 3.55 µg/g creat.	β2M RBP albumin	Significant correlation between urinary cadmium and effect biomarkers. Dose-response relationship between urinary cadmium and prevalence of abnormal effect biomarker levels.	Jin et al. 2002
Residents in cadmium-polluted area (China) 118 males, 170 females in high exposure group 80 males, 158 females in moderate exposure group		β2M NAG NAG-B RBP albumin	Dose-response relationship between urinary cadmium and prevalence of abnormal effect biomarker levels.	Jin et al. 2004c
Residents in cadmium-polluted area (China) 66 males, 22 females	9.12 µg/g creat.	β2M NAG albumin	Dose-response relationship between urinary cadmium and prevalence of abnormal effect biomarker levels.	Jin et al. 2004a
Residents in cadmium-polluted area (China) 120 males, 127 females in high exposure group 125 males, 122 females in moderate exposure group	High: 9.40 µg/L (M) 12.13 µg/L (F) Mod.: 1.28 µg/L (M) 2.05 µg/L (F)	β2M albumin	Dose-response relationship between urinary cadmium and prevalence of abnormal effect biomarker levels.	Nordberg et al. 1997
Residents in cadmium-polluted area (China) 122 males, 125 females	6.1 µg/g creat. (M) 7.5 µg/g creat. (F)	β2M NAG calcium	Effect biomarkers significantly higher than controls. Dose-response relationship between urinary cadmium and effect biomarkers.	Wu et al. 2001
Residents in cadmium-polluted area (Japan) 127 males; mean age 72.1–73.6 years old	6.8–6.9 µg/g creat.	β2M	Higher prevalence of abnormal effect biomarkers compared to controls.	Cai et al. 2001

3. HEALTH EFFECTS

Table 3-7. Summary of Human Studies Examining Renal Effects

Population studied	Mean urinary cadmium level	Effect biomarker	Results	Reference
Residents in cadmium-polluted area (Japan) 1,178 females	3.16–4.08 µg/g creat.	β2M	No significant association between urinary cadmium and effect biomarkers.	Horiguchi et al. 2004
Residents in cadmium-polluted area (Japan) 82 males, 56 females		β2M	Significant association between cadmium intake and effect biomarkers in males only.	Izuno et al. 2000
Residents in cadmium-polluted area (Japan) 634 males, 411 females		Protein	Significant association between cadmium intake and increased prevalence of abnormal levels of urinary protein in males.	Kobayashi et al. 2002a; Watanabe et al. 2002
Residents in cadmium-polluted area (Japan) 1,419 males, 1,745 females	4.6 µg/g creat. (M) 7.2 µg/g creat. (F)	Potassium sodium	Significantly higher urinary potassium levels, compared to controls. Significant correlation between urinary potassium and urinary cadmium and β2M. Urinary sodium not significantly different than controls and not correlated with urinary cadmium.	Monzawa et al. 1998
Residents in cadmium-polluted area (Japan) 44 males, 54 females	2.69 µg/g creat. (M) 4.68 µg/g creat. (F)	β2M pHC NAG protein inorganic phosphorus	Significant correlation between urinary cadmium and effect biomarkers (except β2M in males).	Nakadaira and Nishi 2003
Residents in cadmium-polluted area (Japan) 832 males, 871 females		β2M protein amino nitrogen	Significant correlation between cadmium concentration in rice and effect biomarkers. Dose-response relationship between cadmium levels in rice and prevalence of abnormal β2M (males) and protein (females) levels.	Nakashima et al. 1997
Residents in cadmium-polluted area (Japan) 826 males, 641 females		Protein	Dose response relationship between cadmium levels in rice and prevalence of abnormal effect biomarker levels.	Osawa et al. 2001
Residents in cadmium-polluted area (Japan) 878 males, 972 females		β2M	Dose response relationship between cadmium in rice and effect biomarkers.	Nogawa et al. 1989

3. HEALTH EFFECTS

Table 3-7. Summary of Human Studies Examining Renal Effects

Population studied	Mean urinary cadmium level	Effect biomarker	Results	Reference
Residents in cadmium-polluted area (Japan) 1,424 males, 1,754 females	4.56 µg/g creat. (M) 7.15 µg/g creat. (F)	β2M	β2M significantly higher than controls. Dose-response relationship between urinary cadmium and prevalence of abnormal β2M levels.	Ishizaki et al. 1989
Residents in cadmium-polluted area (Japan) 878 males, 972 females		β2M	Dose response relationship between cadmium in rice and prevalence of abnormal β2M levels.	Kido and Nogawa 1993
Residents in cadmium-polluted area (Japan) 1,403 males, 1,716 females; ≥50 years old	4.56 µg/g creat. (M) 7.15 µg/g creat. (F)	β2M	Dose response relationship between urinary cadmium and prevalence of abnormal β2M levels.	Hayano et al. 1996
Residents in cadmium-polluted area (Japan) 120 males, 280 females	1.78 µg/g creat. (M) 2.27 µg/g creat. (F)	NAG	Significant correlation between urinary cadmium and NAG.	Kawada et al. 1992
Residents in cadmium-polluted area (Japan) 129 females; 34– 74 years of age	6.30 µg/g creat.	β2M	Significant correlation between urinary cadmium and β2M.	Horiguchi et al. 2010
Residents in cadmium-polluted area (Thailand) 58 males, 70 females	12 µg/g creat.	β2M pHC NAG protein albumin	Significant correlation between urinary cadmium and effect biomarkers. Dose-response relationship between urinary cadmium and prevalence of abnormal β2M levels.	Teeyakasem et al. 2007
Residents in cadmium-polluted area (Thailand) 307 males, 488 females; >30 years of age	5.3 µg/g creat. (M) 5.8 µg/g creat. (F)	β2M NAG	Dose-response relationship between urinary cadmium and prevalence of abnormal β2M levels (≥1,000 µg/g creatinine) in females and NAG (≥9 IU/g creatinine) in males and females.	Honda et al. 2010
Residents in cadmium-polluted area (includes occupationally exposed subjects (Sweden)	0.81 µg/g creat. (M) 0.66 µg/g creat. (F)	pHC	Linear relationship between urinary cadmium and pHC (relationship remained significant after removal of occupationally exposed subjects.	Järup et al. 2000

3. HEALTH EFFECTS

Table 3-7. Summary of Human Studies Examining Renal Effects

Population studied	Mean urinary cadmium level	Effect biomarker	Results	Reference
Residents in cadmium-polluted area (Sweden) 57 males, 48 females	0.26 µg/g creat.	β2M protein HC NAG albumin	Significant correlation between urinary and blood cadmium and effect biomarkers. β2M clearance was significantly explained by urinary cadmium levels.	Olsson et al. 2002
Residents in cadmium-polluted area (Poland) 44 males, 128 females only exposed as adults 72 males, 64 females exposed as children	0.97 µg/g creat. (childhood exposure) 2.23 µg/g creat. (adult exposure)	β2M RBP NAG NAG-A NAG-B albumin	In childhood exposure group, significant correlations between urinary cadmium and β2M, RBP, and albumin. In adult exposure group, significant correlations between urinary cadmium and all effect biomarkers.	Trzcinka-Ochocka et al. 2004

AAP = alanine aminopeptidase; β2M = β2-microglobulin; creat. = creatinine; BMI = body mass index; F = female; M = male; Mod. = moderate; NAG = N-acetyl-β-glucosaminidase; NHANES = National Health and Nutrition Examination Survey; pHC = human complex-forming glycoprotein, also referred to as α1M; RBP = retinol binding protein

3. HEALTH EFFECTS

population (mean of 40 years) and study population (mean of 53 years). Based on these recalculations, the urinary cadmium level associated with a 10% increased probability of abnormal pHc values (20% total probability) was 2.62 $\mu\text{g/g}$ creatinine for the total population. In the environmental exposed subgroup, a urinary cadmium level of 0.5 $\mu\text{g/g}$ creatinine was associated with a 13% probability (doubling of the probability in reference population) of abnormal pHc values.

Noonan et al. (2002) examined residents in Pennsylvania living near a defunct zinc smelting facility (geometric mean urinary cadmium level of 0.14 $\mu\text{g/g}$ creatinine) and a reference community located 10 miles from the facility (geometric mean urinary cadmium levels of 0.12 $\mu\text{g/g}$ creatinine). The data from the two communities were pooled because there were no differences in urinary cadmium levels between them. β 2-microglobulin, NAG, alanine aminopeptidase (AAP), and albumin levels were measured as biomarkers of renal dysfunction. The geometric mean urinary cadmium levels were 0.07 and 0.08 $\mu\text{g/g}$ creatinine in 88 males and 71 females aged 6–17 years and 0.24 and 0.23 $\mu\text{g/g}$ creatinine in 71 males and 80 females aged ≥ 18 years. No significant correlations between urinary cadmium levels and renal biomarkers were observed in the children, after adjustment for creatinine, age, and gender. In adults, significant correlations (after adjustment for creatinine, age, gender, smoking, and self-reported diabetes or thyroid disease) between urinary cadmium and NAG (partial correlation coefficient of 0.20, 95% CI of 0.05–0.36) and AAP (partial correlation coefficient of 0.21 and 95% CI of 0.05–0.36) were observed. Significant dose-effect relationships were also found for these two biomarkers. Urinary cadmium levels were not significantly associated with elevated levels of β 2-microglobulin or albumin.

Nogawa et al. (1980) examined 878 males and 972 females aged ≥ 50 years living in the Kakehashi River basin in Japan; the Kakehashi River, cadmium polluted from an upstream mine, was used to irrigate rice fields. β 2-Microglobulin measured in morning urine samples was used as a biomarker of renal dysfunction and cadmium intake was estimated from rice samples collected in 1974. Cadmium levels in rice were considered to be representative of cadmium intake because over 70% of the total cadmium intake has been shown to come from rice. Cadmium in the rice ranged from 0.10 to 0.69 $\mu\text{g/g}$. β 2-Microglobulin levels were significantly higher in the study population compared to a reference population of 113 males and 161 females living in a nearby area. A significant dose-related association between total cadmium intake and prevalence of abnormal β 2-microglobulin values (defined as β 2-microglobulin levels of $\geq 1,000$ $\mu\text{g/g}$ creatinine) was found. The total cadmium intake, which resulted in a prevalence of abnormal β 2-microglobulin levels equal to the control group, was 1,678 mg in males (prevalence in controls was 6.0%) and 1,763 mg in females (prevalence in controls was 5.0%). A further analysis of the exposed subjects (Hochi et al. 1995) found that the prevalence of abnormal

3. HEALTH EFFECTS

β 2-microglobulin levels (using a cut-off level of 1,000 $\mu\text{g/g}$ creatinine) exceeded the prevalence in the reference population when cadmium intake was ≥ 2 g and the subjects were divided into subgroups by age. The prevalence of abnormal β 2-microglobulin levels at a given cadmium intake increased with age.

Yamanaka et al. (1998) examined 558 males and 743 females aged ≥ 50 years living in a cadmium nonpolluted area in Japan. Urinary cadmium level was used as a biomarker of exposure and urinary β 2-microglobulin, total protein, and NAG as biomarkers of renal dysfunction. The geometric mean urinary cadmium levels were 1.3 and 1.3 $\mu\text{g/g}$ creatinine in males and females, respectively. Significant correlations (after adjustment for age) between urinary cadmium levels and total protein, β 2-microglobulin, and NAG were found. Abnormal levels of renal biomarkers were defined as exceeding the 84% upper limit value calculated from a referent group of 2,778 non-exposed individuals; the cut-off values were 124.8 and 120.8 mg/g creatinine for total protein in males and females, 492 and 403 $\mu\text{g/g}$ creatinine for β 2-microglobulin, and 8.0 and 8.5 U/g creatinine for NAG. Dose-response relationships between urinary cadmium levels and prevalence of abnormal levels of β 2-microglobulin, total protein, and NAG were found. The odds ratios (95% CI) were 6.589 (3.383–12.833), 3.065 (1.700–5.526), and 1.887 (1.090–3.268) for protein, β 2-microglobulin, and NAG in males and 17.486 (7.520–40.660), 5.625 (3.032–10.435), and 2.313 (1.399–3.824) for protein, β 2-microglobulin, and NAG in females.

Another study of residents living in a cadmium nonpolluted area of Japan examined 346 males and 529 females from one area (area A) and 222 males and 413 females in another area (area B); all subjects were ≥ 50 years of age and were not occupationally exposed to heavy metals (Oo et al. 2000). The geometric mean urinary cadmium levels were 2.2 and 2.8 $\mu\text{g/L}$ in males and females in area A and 3.4 and 3.9 $\mu\text{g/L}$ in area B. Significant correlations (with adjustment for age) were found between urinary cadmium and urinary levels of protein, β 2-microglobulin (not significant in males in area B) and NAG levels. A significant association between urinary cadmium levels and the prevalence (cut-off levels from same referent population as Yamanaka et al. 1998) of abnormal levels of urinary protein (cut-off level of 113.8 and 96.8 $\mu\text{g/L}$ in males and females), β 2-microglobulin (378 and 275 $\mu\text{g/L}$) (only significant in females in area A), and NAG (8.0 and 7.2 $\mu\text{g/L}$). The odds ratios (95% CI) for an increase in prevalence of abnormal renal biomarkers were 8.810 (3.401–22.819) and 11.282 (3.301–38.362) for protein in males in areas A and B, respectively, 8.234 (3.696–18.343) and 23.901 (8.897–64.210) for protein in females in areas A and B; 2.558 (1.246–5.248) for β 2-microglobulin in females in area A; 47.944 (14.193–161.954) and 9.940 (3.153–31.340) for NAG in males in areas A and B; and 72.945 (21.873–243.263) and 25.374 (9.452–68.117) for NAG in females in areas A and B.

3. HEALTH EFFECTS

In a re-examination of the populations studied by Yamanaka et al. (1998) and Oo et al. (2000), Suwazono et al. (2000) measured cadmium levels in blood and urine and urinary levels of total protein, β 2-microglobulin, and NAG in 1,105 males and 1,648 females over the age of 50 years. The geometric mean concentrations of cadmium in urine were 1.8 and 2.4 $\mu\text{g/g}$ creatinine in males and females, respectively, and blood cadmium levels were 2.0 and 1.8 ng/g in males and females. After adjustment for age, significant associations between urinary cadmium levels and urinary protein and β 2-microglobulin in males and females were found. Additionally, blood cadmium levels were significantly associated with urinary protein and NAG levels in males and urinary protein, β 2-microglobulin, and NAG levels in females. Cut-off levels (defined as the 84% upper limit values from 424 male and 1,611 female nonsmoking subjects) of 157.4 and 158.5 mg/g creatinine for protein in males and females, respectively, 507 and 400 $\mu\text{g/g}$ creatinine for β 2-microglobulin in males and females, respectively, and 8.2 and 8.5 $\mu\text{g/g}$ creatinine for NAG in males and females, respectively, were used to evaluate the prevalence of abnormal levels of renal biomarkers. Logistic regression analysis demonstrated significant associations between urinary cadmium levels and increased prevalence of abnormal levels of total protein (odds ratio of 3.923, 95% CI of 2.2028–7.590) and β 2-microglobulin (odds ratio of 2.259, 95% CI of 1.372–3.717) in males; in females, significant associations were found for total protein (odds ratio of 7.763; 95% CI of 4.231–14.243), β 2-microglobulin (odds ratio of 2.259, 95% CI of 1.879–4.281), and NAG (odds ratio of 1.882, 95% CI of 1.311–2.702). For blood cadmium levels, the only significant association found was for an increased prevalence of abnormal total protein levels in females (odds ratio of 3.490, 95% CI of 1.661–7.331).

Jin et al. (2002) examined three populations living various distances from a nonferrous metal smelter. The geometric mean levels of urinary cadmium were 11.18 and 12.86 $\mu\text{g/g}$ creatinine in males ($n=294$) and females ($n=171$) in the highly polluted area, 3.55 and 4.45 $\mu\text{g/g}$ creatinine in males ($n=243$) and females ($n=162$) in the moderately polluted area, and 1.83 and 1.79 $\mu\text{g/g}$ creatinine in males ($n=253$) and females ($n=155$) in the control area. Significant correlations were found between urinary (and blood) cadmium levels and renal biomarkers (β 2-microglobulin, retinol binding protein, and albumin). Cut-off values for β 2-microglobulin, retinol binding protein, and albumin of 300 $\mu\text{g/g}$ creatinine, 300 $\mu\text{g/g}$ creatinine, and 15 mg/g creatinine, respectively, were used to assess possible dose-response relationships (no additional information was provided); although 300 $\mu\text{g/g}$ creatinine was reported as the cut-off values for β 2-microglobulin, subsequent analysis of this data set (Jin et al. 2004c) reported a cut-off value of 800 $\mu\text{g/g}$ creatinine. Significant dose-response relationships between urinary (and blood) cadmium and the prevalence of abnormal levels of renal markers of kidney dysfunction were found.

3. HEALTH EFFECTS

Unlike the studies discussed above, Hellström et al. (2001) used the incidence of renal replacement therapy (dialysis or kidney transplantation) as an indicator of renal dysfunction, in particular, end-stage renal disease. Residents of Kalmar County, Sweden were divided into four exposure groups: high exposure (workers at cadmium battery production facility), moderate (residents living within 2 km of the cadmium battery facility), low (residents living between 2 and 10 km of the facility), and no exposure (residents living at least 10 km from the facility); all subjects were 20–79 years of age. The Mantel-Haenszel rate ratio (MH-RR) for renal replacement therapy in the cadmium exposed group was 1.8 (95% CI 1.3–2.3); among the environmentally exposed group, the MH-RR was 1.7 (95% CI 1.3–2.3). The age SRRs were 1.9 (95% CI 1.3–2.5) and 1.9 (95% CI 1.2–2.6) for subjects in the moderate exposure group aged 20–79 years or 40–79 years, respectively. The trend for increasing MH-RR with increasing exposure was statistically significant. The age SRRs were not significantly elevated in the low exposure group. The investigators noted that the causes of end stage renal disease were similar in the cadmium exposed and unexposed groups. When only primary renal diseases (excludes renal failure secondary to diabetes or vascular or systemic diseases) were considered, the MH-RR was 1.7 (95% CI 1.1–2.6) for all cadmium exposed individuals and 2.1 (95% CI 1.4–3.2) for cadmium exposed individuals aged 40–79 years. Although urinary cadmium levels were not assessed in this study, other studies in this area found mean urinary cadmium levels of 1.0 and 0.46 $\mu\text{g/g}$ creatinine in residents living within 0.5 and 0.5–1 km, respectively, of the battery facility (Järup et al. 1995a) and 0.38 and 0.55 $\mu\text{g/g}$ creatinine in men and women, respectively, living in the contaminated area (Alfvén et al. 2000). Ferraro et al. (2011) and Swaddiwudhipong et al. (2011) used another approach for evaluating kidney damage by examining the association between elevated urinary cadmium levels and kidney stone formation. Using the NHANES survey data from 1988 to 1994, Ferraro et al. (2011) found significantly higher urinary cadmium levels in individuals with a history of kidney stone formation, as compared to individuals without a history of kidney stone formation. However, after adjusting for age, race/ethnicity, BMI, smoking habits, region of residence, and daily intake of calcium and sodium, a significant association was only found in females; the odds ratio of kidney stones was 1.40 (95% CI of 1.06–1.86) among individuals with a urinary cadmium level of $>1 \mu\text{g/g}$. Swaddiwudhipong et al. (2011) found a significant association between urinary cadmium levels and prevalence of urinary stone formation among adults living in cadmium-contaminated areas of Thailand.

Although there is strong evidence to suggest a relationship between urinary cadmium excretion and excretion of renal biomarkers (particularly low molecular weight proteins such as β 2-microglobulin, pHC, and retinol binding protein), there is less agreement about the significance of the early renal changes and the threshold urinary cadmium levels associated with renal damage. Several studies monitoring

3. HEALTH EFFECTS

populations following a decrease in cadmium exposure have attempted to address the question of the reversibility of early renal changes. In Japan, cadmium-contaminated soil used in rice paddies was replaced resulting in decreasing urinary cadmium levels in residents consuming rice grown in these fields (Cai et al. 2001; Iwata et al. 1993; Kobayashi et al. 2008b; Sato et al. 2010). Although, cadmium exposure decreased over the same time period, the levels of renal biomarkers increased (Cai et al. 2001; Iwata et al. 1993; Kido et al. 1988; Kobayashi et al. 2008b; Sato et al. 2010) and the prevalence of abnormal values remained higher compared to the reference population (Cai et al. 2001). Although significant decreases in urinary cadmium levels were observed over time, cadmium burdens still remained high; urinary cadmium levels at the later time periods were 6.03–9.6 $\mu\text{g/g}$ creatinine (Cai et al. 2001; Iwata et al. 1993; Kido et al. 1988). Kobayashi et al. (2008b) found significant correlations (after adjustment for age) between the amount of time since soil replacement and increases in urinary levels of retinol binding protein, total protein, and glucose (males only). In contrast, a follow-up study of a portion of the population examined by Buchet et al. (1990) found small, but statistically significant, decreases in urinary cadmium levels and urinary levels of β 2-microglobulin, NAG, and retinol binding protein (Hotz et al. 1999). Urinary cadmium levels in this study (0.6–0.9 $\mu\text{g/g}$ creatinine at baseline and 0.5–0.8 $\mu\text{g/g}$ creatinine at follow up) were much lower than levels in the Japanese studies. Wu et al. (2008) examined biomarkers of renal dysfunction before (measured in 1995) and after (measured in 1998) remediation in 148 adults living in an area of China with cadmium pollution. The subjects were divided into two groups based on whether or not they had elevated β 2-microglobulin levels in 1995. Among the subjects with no alteration in β 2-microglobulin levels in 1995, there were no significant changes in β 2-microglobulin levels in subjects with urinary cadmium levels of <10 $\mu\text{g/g}$ creatinine in 1995 and significant increases in β 2-microglobulin levels in the subjects with initial urinary cadmium levels of ≥ 10 $\mu\text{g/g}$ creatinine. In the subjects with elevated β 2-microglobulin levels in 1995, there were significant decreases in β 2-microglobulin in subjects with urinary cadmium levels of <5 $\mu\text{g/g}$ creatinine, no changes in subjects with urinary cadmium levels of 5 $\mu\text{g/g}$ creatinine, and significant increases in β 2-microglobulin levels in subjects with urinary cadmium levels of ≥ 10 $\mu\text{g/g}$ creatinine. A similar pattern was found for urinary albumin levels, with significant decreases in urinary albumin levels in subjects previously diagnosed with albuminuria and urinary cadmium levels of <5 $\mu\text{g/g}$ creatinine and no changes in urinary albumin levels in subjects with urinary cadmium levels of ≥ 5 $\mu\text{g/g}$ creatinine. In subjects without albuminuria in 1995, there were increases at the higher urinary cadmium levels (5 and 20 $\mu\text{g/g}$ creatinine). Although the data are inconclusive, the results of these studies provide some indication of reversibility of renal damage resulting from substantial decreases in cadmium exposure among subjects exposed to low levels of cadmium. However, renal damage may continue to progress in subjects initially exposed to higher levels of cadmium.

3. HEALTH EFFECTS

A number of investigators have examined different approaches to establishing a safe cadmium body burden (as assessed by urinary cadmium levels). Several BMD analyses of data from populations living in cadmium nonpolluted areas in Sweden (Suwazono et al. 2006) or Japan (Kobayashi et al. 2006, 2008a; Suwazono et al. 2011a, 2011b, 2011c; Uno et al. 2005) or cadmium polluted areas in Japan (Shimizu et al. 2006) or China (Jin et al. 2004c) have been conducted. The analyses used urinary cadmium levels as a biomarker of cadmium exposure and the prevalence of abnormal levels of β 2-microglobulin, pHc, protein, NAG, retinol binding protein, albumin, or glomerular filtration rate as biomarkers of renal effects. Two approaches were used for BMD modeling: dichotomous variable (Jin et al. 2004c; Kobayashi et al. 2006; Shimizu et al. 2006; Uno et al. 2005) or hybrid (Kobayashi et al. 2008a; Suwazono et al. 2006, 2011a, 2011b, 2011c) approaches. In the dichotomous variable approach, urinary cadmium excretion was divided into categories and the distribution of abnormal values (exceeding the cut-off value) was fit to dichotomous BMD models. As noted by Suwazono et al. (2010), one limitation of this approach is that it does not allow for adjustment for potential covariates, particularly age; additionally, the results may fluctuate depending on the categorization of exposure, number of categories, or dose intervals. The hybrid approach eliminates the categorization of subjects by exposure (e.g., urinary cadmium levels) and is based on a continuous measure of outcome and allows for the adjustment of potential covariates such as age and BMI. As summarized in [Table 3-8](#), the BMDs for urinary cadmium levels vary widely between the studies depending on the renal biomarker and the cut-off level used. For example, when NAG is used as the effect biomarker, the BMD_{0.05} (dose associated with a 5% extra risk) values of 0.64, 12.0–10.8, and 6.36–7.74 $\mu\text{g/g}$ creatinine were calculated by Suwazono et al. (2006), Kobayashi et al. (2006), and Jin et al. (2004c) when the 95% upper limit cut-off value of 3.6, 16.0–16.6, and 15.0 U/g creatinine, respectively, was used. The results of the two BMD approaches were similar when similar cut-off levels were used. The BMDL (95% confidence bound of the BMD) is typically considered a no adverse effect level; the results of these BMD analyses suggest that chronic exposure to cadmium resulting in urinary cadmium levels of 0.3–11.31 or 0.6–11.4 $\mu\text{g/g}$ creatinine would be associated with a 5 or 10% additional risk of renal dysfunction.

Ikeda and associates used regression analysis to predict a threshold urinary cadmium level. Plotting urinary cadmium levels against β 2-microglobulin levels taken from published data from populations living in cadmium polluted and non polluted areas of Japan resulted in a distribution shaped like the letter “J”. The threshold level was defined as the point of flexion in the “J” shaped curve. In the first investigation (Ikeda et al. 2003b), the point of flexion was estimated as the point of intersection between two regression lines: one with no elevation in β 2-microglobulin from non-exposed populations and the

3. HEALTH EFFECTS

Table 3-8. Benchmark Dose Estimations of Urinary Cadmium Levels ($\mu\text{g/g}$ Creatinine)

Study population	Effect biomarker	Response criterion	BMD model	5% BMR		10% BMR		Reference
				BMD	BMDL	BMD	BMDL	
General population (Sweden) 790 females; 53–64 years old	NAG	3.6 U/g creat. (95% cut-off) ^a	Profile likelihood method	0.64	0.50	1.08	0.83	Suwazono et al. 2006
	pHC	6.8 mg/g creat. (95% cut-off) ^a		0.63	0.49	1.05	0.81	
	Estimated GFR	78.5 mL/minute (95% cut-off) ^a		1.08	0.70	1.80	1.18	
Residents in cadmium-polluted (1,397 males, 1,706 females) and cadmium nonpolluted areas (Japan) (130 males, 159 females); ≥ 50 years old	$\beta 2\text{M}$	507 $\mu\text{g/g}$ creat. (M)	Quantal linear model	1.5 (M)	1.2 (M)	3.1 (M)	2.5 (M)	Shimizu et al. 2006
		400 $\mu\text{g/g}$ creat. (F)		1.4 (F)	1.1 (F)	2.9 (F)	2.3 (F)	
		507 $\mu\text{g/g}$ creat. (M)	Log-logistic model	3.7 (M)	2.9 (M)	5.1 (M)	4.2 (M)	
		400 $\mu\text{g/g}$ creat. (F)		2.6 (F)	1.5 (F)	6.3 (F)	2.7 (F)	
		994 $\mu\text{g/g}$ creat. (M)		Quantal linear model	2.3 (M)	1.8 (M)	4.7 (M)	
784 $\mu\text{g/g}$ creat. (F)	1.7 (F)	1.4 (F)			3.5 (F)	2.9 (F)		
994 $\mu\text{g/g}$ creat. (M)	Log-logistic model	4.8 (M)	3.9 (M)	6.3 (M)	5.5 (M)			
784 $\mu\text{g/g}$ creat. (F)		4.4 (F)	3.2 (F)	6.4 (F)	5.1 (F)			
Residents in cadmium-polluted (1,397 males, 1,706 females) ^d and cadmium nonpolluted areas (Japan) (520 males, 700 females); ≥ 50 years old	$\beta 2\text{M}$	915.5 $\mu\text{g/g}$ creat. (M)	Profile likelihood method	4.0 (M)	3.5 (M)			Suwazono et al. 2011b
		897.1 $\mu\text{g/g}$ creat. (F)		4.0 (F)	(3.7) (F)			

3. HEALTH EFFECTS

Table 3-8. Benchmark Dose Estimations of Urinary Cadmium Levels ($\mu\text{g/g}$ Creatinine)

Study population	Effect biomarker	Response criterion	BMD model	5% BMR		10% BMR		Reference
				BMD	BMDL	BMD	BMDL	
General population (Japan) 1,114 males, 1,664 females	Protein	157 mg/g creat. (M)	Log-logistic model	3.6 (M)	3.1 (M)	5.6 (M)	4.9 (M)	Kobayashi et al. 2006
		159 mg/g creat. (F)		4.8 (F)	4.2 (F)	7.5 (F)	6.6 (F)	
		(84% cut-off) ^f						
		309 mg/g creat. (M)		10.6 (M)	6.8 (M)	15.3 (M)	9.6 (M)	
		311 mg/g creat. (F)		8.7 (F)	7.3 (F)	12.0 (F)	9.9 (F)	
		(95% cut-off) ^g						
	β2M	507 $\mu\text{g/g}$ creat. (M)		2.9 (M)	2.4 (M)	5.0 (M)	4.0 (M)	
		400 $\mu\text{g/g}$ creat. (F)		3.8 (F)	3.3 (F)	6.6 (F)	5.5 (F)	
		(84% cut-off) ^f						
		994 $\mu\text{g/g}$ creat. (M)		6.4 (M)	4.5 (M)	10.2 (M)	7.1 (M)	
		784 $\mu\text{g/g}$ creat. (F)		8.7 (F)	7.3 (F)	12.0 (F)	9.9 (F)	
		(95% cut-off) ^g						
NAG	8.2 U/g creat. (M)	4.8 (M)	3.3 (M)	8.3 (M)	5.7 (M)			
	8.5 U/g creat. (F)	4.7 (F)	3.7 (F)	8.3 (F)	6.4 (F)			
	(84% cut-off) ^f							
	16.0 U/g creat. (M)	12.0 (M)	7.7 (M)	16.4 (M)	10.3 (M)			
	16.6 U/g creat. (F)	10.8 (F)	8.5 (F)	14.8 (F)	11.4 (F)			
	(95% cut-off) ^g							
General population (Japan) 1,181 males, 1,748 females	β2M	492 $\mu\text{g/g}$ creat. (M)	Multiple logistic model	3.0 (M)	2.7 (M)	5.0 (M)	4.6 (M)	Kobayashi et al. 2008a
		407 $\mu\text{g/g}$ creat. (F)		3.4 (F)	3.2 (F)	5.7 (F)	5.4 (F)	
		(84% cut-off) ^h						
		965 $\mu\text{g/g}$ creat. (M)		4.9 (M)	4.5 (M)	7.4 (M)	6.8 (M)	
		798 $\mu\text{g/g}$ creat. (F)		5.9 (F)	5.6 (F)	8.6 (F)	8.1 (F)	
(97.5% cut-off) ⁱ								
1,000 $\mu\text{g/g}$ creat.	5.0 (M)	4.6 (M)	7.5 (M)	6.9 (M)				
	6.7 (F)	6.3 (F)	9.4 (F)	8.9 (F)				

3. HEALTH EFFECTS

Table 3-8. Benchmark Dose Estimations of Urinary Cadmium Levels ($\mu\text{g/g}$ Creatinine)

Study population	Effect biomarker	Response criterion	BMD model	5% BMR		10% BMR		Reference
				BMD	BMDL	BMD	BMDL	
General population (Japan) 547 males, 723 females; aged ≥ 50 years	Protein	159 mg/g creat. (M)	Profile likelihood method	2.6 (M)	2.1 (M)			Suwazono et al. 2011c
		93 mg/g creat. (F) (95% cut-off) ^a		1.7 (F)	1.5 (M)			
	$\beta 2\text{M}$	708 $\mu\text{g/g}$ creat. (M) 415 $\mu\text{g/g}$ creat. (F) (95% cut-off) ^e		3.4 (M) 1.7 (F)	2.6 (M) 1.4 (F)			
	NAG	10.7 IU/g creat. (M) 11.1 IU/g creat. (F) (95% cut-off) ⁱ		6.3 (M) 4.3 (F)	4.1 (M) 3.1 (F)			
General population (Japan) 410 males, 418 females; 40–59 years old	Protein	70 mg/g creat. (M)	Quantal linear model	0.9 (M)	0.6 (M)	1.9 (M)	1.2 (M)	Uno et al. 2005
		70 mg/g creat. (F) (84% cut-off) ^k		3.2 (F)	1.8 (F)	6.6 (F)	3.6 (F)	
	$\beta 2\text{M}$	233 $\mu\text{g/g}$ creat. (M) 274 $\mu\text{g/g}$ creat. (F) (84% cut-off) ^k		0.5 (M) 0.9 (F)	0.4 (M) 0.8 (F)	1.0 (M) 1.8 (F)	0.7 (M) 1.3 (F)	
	NAG	2.4 U/g creat. (M) 2.5 U/g creat. (F) (84% cut-off) ^k		0.3 (M) 0.8 (F)	0.3 (M) 0.6 (F)	0.7 (M) 1.6 (F)	0.6 (M) 1.2 (F)	
General population (Japan) ^l 209 males, 215 females; 40–49 years old	Protein	67.7 mg/g creat. (M)	Profile likelihood method	1.3 (M)	0.9 (M)			Suwazono et al. 2011a
		94.6 mg/g creat. (F) (95% cut-off) ^a		3.2 (F)	1.9 (F)			
	$\beta 2\text{M}$	224.5 $\mu\text{g/g}$ creat. (M) 298.9 $\mu\text{g/g}$ creat. (F) (95% cut-off) ^a		0.9 (M) 2.2 (F)	0.7 (M) 1.5 (F)			
	NAG	2.2 IU/g creat. (M) 2.1 IU/g creat. (F) (95% cut-off) ^a		0.7 (M) 1.3 (F)	0.6 (M) 0.6 (F)			

3. HEALTH EFFECTS

Table 3-8. Benchmark Dose Estimations of Urinary Cadmium Levels ($\mu\text{g/g}$ Creatinine)

Study population	Effect biomarker	Response criterion	BMD model	5% BMR		10% BMR		Reference
				BMD	BMDL	BMD	BMDL	
General population (Japan) ^f 201 males, 203 females; 50–59 years	Protein	94.5 mg/g creat. (M)	Profile likelihood method	1.6 (M)	1.1 (M)			Suwazono et al. 2011a
		92.7 mg/g creat. (F) (95% cut-off) ^a		5.7 (F)	3.4 (F)			
	β 2M	322.1 $\mu\text{g/g}$ creat. (M)	1.8 (M)	1.2 (M)				
296.7 $\mu\text{g/g}$ creat. (F) (95% cut-off) ^a		2.4 (F)	1.8 (F)					
	NAG	2.5 IU/g creat. (M)		1.0 (M)	0.8 (M)			
		3.3 IU/g creat. (F) (95% cut-off) ^a		3.2 (F)	2.3 (F)			
Residents in cadmium highly polluted area (China) 123 males, 171 females	NAG	15.0 U/g creat. (95% cut-off) ^m	Quantal linear logistic regression model	6.36 (M)	5.83 (M)			Jin et al. 2004c
	NAG-B	4.0 U/g creat. (95% cut-off) ^k		7.74 (F)	5.46 (F)			
		β 2M		800 $\mu\text{g/g}$ creat. (95% cut-off) ^m	4.88 (M)	3.98 (M)	4.24 (F)	
Residents in cadmium moderately polluted area (China) 81 males, 162 females	RBP	0.300 mg/g creat. (95% cut-off) ^m		5.86 (M)	4.74 (M)			
				9.98 (F)	8.47 (F)			
	Albumin	25.0 mg/g creat. (95% cut-off) ^m		5.99 (M)	4.87 (M)	9.03 (F)	7.63 (F)	
				16.72 (M)	11.18 (M)			
				14.42 (F)	11.31 (F)			

^a95th percentile of effect biomarkers on the “hypothetical” control distribution at a urinary cadmium level of zero.

^b84% upper limit values from a group of 424 males and 1,611 females who did not smoke and lived in three different cadmium nonpolluted areas.

^c95% upper limit values from a group of 424 males and 1,611 females who did not smoke and lived in three different cadmium nonpolluted areas.

^dSame population of residents living in polluted area as Shimizu et al. (2006).

^e95th percentile calculated by benchmark model at no cadmium exposure (urinary cadmium equal to zero), adjusted to mean age.

^f84% upper limit value of the target population of people who have not smoked.

^g95% upper limit value of the target population of people who have not smoked.

^h84th percentile level in subjects from nonpolluted areas.

ⁱ97.5th percentile level in subjects from nonpolluted areas.

^j95th percentile calculated by benchmark model at no cadmium exposure (urinary cadmium equal to zero), adjusted to mean age in females only.

^k84% upper limit value of the target population.

^lSame population as Uno et al. (2005), divided into two age groups.

^m95% upper limit value from a control group 98 males and 155 females living in a cadmium nonpolluted area.

BMD = benchmark dose; BMDL = lower 95% confidence limit on the benchmark dose; BMR = benchmark response; β 2M = β 2-microglobulin; creat. = creatinine; F = female; M = male; NAG = *N*-acetyl- β -D-glucosaminidase; NAG-B = *N*-acetyl- β -D-glucosaminidase's isoform B; RBP = retinol binding protein

3. HEALTH EFFECTS

other when β 2-microglobulin was >400 or $>1,000$ $\mu\text{g/g}$ creatinine using data from exposed populations. Although no specific data were given for the two populations, the investigators noted that the highest urinary cadmium levels in the non-exposed populations were 5.6 and 3.6 $\mu\text{g/g}$ creatinine in females and males, respectively. The points of intersection of the regression lines were 11.0 and 11.7 $\mu\text{g/g}$ creatinine in females using the >400 and 1,000 $\mu\text{g/g}$ creatinine criteria, respectively, and 10.0 and 11.0 $\mu\text{g/g}$ creatinine in males. The second investigation also used published data on Japanese populations living in polluted and nonpolluted areas (Ikeda et al. 2005b). The urinary cadmium levels ranged from 0.2 to 7.8 $\mu\text{g/g}$ creatinine and from 0.8 to 31.6 $\mu\text{g/g}$ creatinine in the nonpolluted and polluted areas, respectively, and the data for the two populations were combined. Plotting urinary cadmium levels against β 2-microglobulin levels showed that there was a marked increase in β 2-microglobulin levels (levels exceeded 1,000 $\mu\text{g/g}$ creatinine) when urinary cadmium levels exceeded 4 $\mu\text{g/g}$ creatinine. The urinary cadmium levels at the point of intersection of the regression line for urinary cadmium levels of ≤ 2 or ≤ 5 $\mu\text{g/g}$ creatinine was 6.7 and 6.7 $\mu\text{g/g}$ creatinine using ordinary scales and 3.7 and 3.7 $\mu\text{g/g}$ creatinine using double logarithmic scales. These urinary cadmium levels corresponded to β 2-microglobulin levels of 139 and 267 $\mu\text{g/g}$ creatinine with the ordinary scales and 118 and 118 $\mu\text{g/g}$ creatinine using the double logarithmic scales. Using these regression equations and a critical β 2-microglobulin level of 1,000 $\mu\text{g/g}$ creatinine resulted in urinary cadmium levels of 7.6 (ordinary scales) or 8.1 (double logarithmic scales) $\mu\text{g/g}$ creatinine. Based on this analysis, the investigators concluded that at urinary cadmium levels of >4 $\mu\text{g/g}$ creatinine, there is a substantial increase in β 2-microglobulin levels (Ikeda et al. 2005b). Similarly, Kobayshi et al. (2009a) estimated the threshold level for lifetime cadmium intake using BMD modeling in 2607 adults, aged ≥ 50 years, residing for at least 30 years in an area of Japan with known cadmium contamination. A lifetime cadmium intake of 1.16–2.43 g in males and 0.86–1.79 g in women would be associated with a 5% additional risk of proteinuria and/or glucosuria.

A third approach used to identify a threshold level was a meta-analysis conducted by Gamo et al. (2006) using published data on environmentally exposed populations. Urinary cadmium was used as a biomarker of exposure and the prevalence of abnormal levels of β 2-microglobulin as an indicator of renal dysfunction. The investigators estimated maximum permissible geometric mean urinary cadmium levels in age- and gender-specific populations that would not result in a significant increase in the prevalence of abnormal β 2-microglobulin levels. They concluded that the geometric mean urinary cadmium level for a population in a small geographical area should not exceed 3 $\mu\text{g/g}$ creatinine; in a nationwide population, the geometric mean should not exceed 2 $\mu\text{g/g}$ creatinine.

3. HEALTH EFFECTS

Numerous studies in rats, mice, and rabbits confirm that oral exposure to cadmium causes kidney damage including proteinuria and tubular damage (Andersen et al. 1988; Bernard et al. 1980, 1988a, 1992; Bomhard et al. 1984; Borzelleca et al. 1989; Cardenas et al. 1992a, 1992b; Cha 1987; Fingerle et al. 1982; Gatta et al. 1989; Gill et al. 1989b; Itokawa et al. 1974; Kawamura et al. 1978; Kotsonis and Klaassen 1978; Kozłowska et al. 1993; Mangler et al. 1988; Masaoka et al. 1994; Pleasants et al. 1992, 1993; Prigge 1978a; Steibert et al. 1984; Stowe et al. 1972; Wilson et al. 1941). Histopathological findings include focal necrosis of proximal tubular epithelial cells and cloudy swelling in renal tubules (Cha 1987). Some studies have also shown no effect on renal function (Basinger et al. 1988; Borzelleca et al. 1989; Boscolo and Carmignani 1986; Groten et al. 1990; Jamall et al. 1989; Loeser and Lorke 1977a, 1977b).

In acute-duration gavage studies in rats, decreased urine flow (Kotsonis and Klaassen 1977) and histopathologic evidence of kidney damage have been reported (Borzelleca et al. 1989) at the very high doses of 150 and 138 mg/kg/day, respectively. No effect on renal function was reported in rats receiving 13.9 mg/kg/day for 10 days in drinking water (Borzelleca et al. 1989). Mice treated with a single gavage dose showed tubular necrosis at 88.8 mg/kg in one study (Andersen et al. 1988), but no effects on the kidney in another study at a dose of 112 mg/kg (Basinger et al. 1988). Proteinuria is a common finding in intermediate-duration oral exposure studies in rats (Bernard et al. 1988a; Cardenas et al. 1992a, 1992b; Kotsonis and Klaassen 1978; Prigge 1978a), as are histopathologic changes in the kidney (Gatta et al. 1989; Itokawa et al. 1974; Kotsonis and Klaassen 1978; Wilson et al. 1941). Renal clearance was decreased in one study (Kawamura et al. 1978). Both increases (Pleasants et al. 1992, 1993) and decreases (Kozłowska et al. 1993) in relative kidney weight have been reported. These effects occurred in rats at doses ranging from 2 to 30 mg/kg/day. No renal effects were seen in dogs receiving 0.75 mg/kg/day cadmium for 3 months (Loeser and Lorke 1977b), but interstitial renal fibrosis was observed in rabbits exposed to 14.9 mg/kg/day for 200 days (Stowe et al. 1972). Renal dysfunction has been reported in Rhesus monkeys exposed to 1.2 mg/kg/day for 9 years, but not at 0.4 mg/kg/day (Masaoka et al. 1994). Adverse renal effects are common in rats following chronic-duration oral exposure to cadmium. Proteinuria (Bernard et al. 1992; Bomhard et al. 1984) and histopathologic damage (Fingerle et al. 1982; Mangler et al. 1988) have been reported at doses ranging from 1.8 to 12.5 mg/kg/day cadmium.

The hypothesis that a critical concentration of approximately 200 $\mu\text{g/g}$ in the renal cortex must be reached before proteinuria develops is generally supported by the animal data (Bhattacharyya et al. 1988c; Kotsonis and Klaassen 1978; Mangler et al. 1988; Shaikh et al. 1989; Viau et al. 1984).

3. HEALTH EFFECTS

Endocrine Effects. Using data from the NHANES 1988–1994, Schwartz et al. (2003) investigated possible associations between cadmium exposure (as measured by urinary cadmium levels) and the prevalence of impaired fasting glucose and diabetes. Analysis on 8,722 participants of the survey (≥ 40 years old) showed a dose-related increase in both impaired fasting glucose and diabetes after adjusting for age, ethnicity, sex, and BMI. No other studies were located regarding endocrine effects in humans after oral exposure to cadmium.

Studies on the potential toxicity of cadmium to the endocrine system consist of studies conducting histopathologic examination of endocrine tissues and studies examining 24-hour variations in hormone release. No adverse effects were seen in parathyroid glands from female Wistar rats exposed to 8 mg Cd/kg/day via drinking water for 90 days (Kawamura et al. 1978) or in adrenal gland from male Sprague-Dawley rats exposed to 8 mg/kg/day via drinking water for 24 weeks (Kotsonis and Klaassen 1978). Pituitary, adrenals, thyroid, and thymus were unaffected in Wistar rats exposed to 3 mg/kg/day cadmium via feed for 3 months (Loeser and Lorke 1977a). Wilson et al. (1941) reported pancreatic atrophy and pancreatitis in rats from cadmium at 2.79 mg/kg/day via feed for 100 days. In rabbits exposed to 14.9 mg Cd/kg body weight/day via drinking water for 200 days, the pancreas had moderate concentrations of cadmium, but no interstitial fibrosis or other pathologic alterations (Stowe et al. 1972). Alterations in the 24-hour pattern of plasma adrenocorticotropin hormone and growth hormone levels were observed in rats exposed to 0.92 or 1.8 mg Cd/kg/day as cadmium chloride in drinking water for 30 days (Caride et al. 2010b); significant increases in adrenocorticotropin hormone and thyroid stimulating hormone levels were also observed. Cadmium also disrupted the daily pattern of aspartate, glutamate, and glutamine content in the anterior and posterior pituitary gland in rats exposed to 0.92 or 1.8 mg Cd/kg/day as cadmium chloride in drinking water for 30 days (Caride et al. 2010a).

Dermal Effects. No studies were located regarding dermal effects in humans after oral exposure to cadmium.

Coarse fur was reported in Long-Evans rats receiving 6.13 mg/kg/day cadmium during Gd 6–15 (Machemer and Lorke 1981). A ruffled hair coat was reported in Wistar rats receiving 40 mg/kg/day cadmium by gavage 5 days/week for 14 weeks (Baranski and Sitarek 1987). No other reports of dermal effects after oral exposure to cadmium were located.

Ocular Effects. No studies were located regarding ocular effects in humans or animals after oral exposure to cadmium.

3. HEALTH EFFECTS

Body Weight Effects. No studies were located regarding body weight effects in humans after oral exposure to cadmium.

Decreased body weight and decreased rates of growth are common findings in studies where experimental animals are orally exposed to cadmium. Sprague-Dawley rats receiving a single gavage dose of 150 mg/kg cadmium exhibited a 12% decrease in body weight, but 100 mg/kg had no effect (Kotsonis and Klaassen 1977). Daily gavage doses of 15.3 mg/kg over a 10-day period caused a 79% decrease in body weight gain in male Sprague-Dawley rats (Borzelleca et al. 1989). Significant reductions in maternal weight gain have also been reported (Baranski 1985; Macheimer and Lorke 1981).

Body weight reductions are also seen in intermediate-duration studies. For example, in a 14-week exposure via drinking water in male Long-Evans rats, 2.9 mg/kg/day had no effect on body weight gain; however, 5.8 mg/kg/day caused a 6–23% decrease and 11.6 mg/kg/day caused a 47–58% decrease (Pleasant et al. 1992, 1993). In general, intermediate-duration doses in feed or drinking water of ≤ 3 mg/kg/day have either no effect or only a small effect (10–20% decrease) on body weight in rats (Carmignani and Boscolo 1984; Jamall et al. 1989; Loeser and Lorke 1977a; Muller et al. 1988; Ogoshi et al. 1989; Perry et al. 1989; Wilson et al. 1941). Higher doses (4–14 mg/kg/day) had no effect in some studies (Kostial et al. 1993; Kotsonis and Klaassen 1978; Prigge 1978a; Viau et al. 1984) and small effects in others (Cha 1987; Kawamura et al. 1978; Kozlowska et al. 1993). A 29% decrease in maternal weight gain was observed in rats exposed to a high dose of 40 mg/kg/day (Baranski and Sitarek 1987). In mice, a dose of 4.8 mg/kg/day had no effect on maternal weight gain, but a dose of 9.6 mg/kg/day caused a 14% decrease (Webster 1978). A high dose of 232 mg/kg/day in mice caused a 29% decrease in body weight (Waalkes et al. 1993). Beagle dogs were unaffected at 0.75 mg/kg/day (Loeser and Lorke 1977b), as were rabbits at up to 2.2 mg/kg/day (Boscolo and Carmignani 1986; Tomera and Harakal 1988). A small decrease (11%) was seen in rabbits exposed to 14.9 mg/kg/day for 200 days (Stowe et al. 1972).

A chronic-duration study in Rhesus monkeys reported decreased growth rates at 0.4 mg/kg/day, but no effect at 0.12 mg/kg/day (Masaoka et al. 1994). No effect on body weight was seen in rats at up to 4.4 mg/kg/day (Decker et al. 1958; Fingerle et al. 1982; Mangler et al. 1988), but a small effect was seen at 7 mg/kg/day (Waalkes and Rehm 1992). Decreased terminal body weight was observed in mice after 12 months of drinking-water exposure to a high dose of 57 mg/kg/day (Hays and Margaretten 1985).

3. HEALTH EFFECTS

Metabolic Effects. Hyperthermia and metabolic acidosis were reported in a human male who had ingested 25 mg/kg cadmium as cadmium iodide (Wisniewska-Knypl et al. 1971).

No studies were located regarding metabolic effects in animals after oral exposure to cadmium.

3.2.2.3 Immunological and Lymphoreticular Effects

No studies were located regarding immunological effects in humans after oral exposure to cadmium.

Numerous studies in rats, mice, and monkeys have established the capability of cadmium to affect the immune system, but the clinical significance of the effects is not clear. In mice, intermediate-duration oral exposure to cadmium has been shown to increase resistance to viral infection (Exon et al. 1986), to be without effect on natural or acquired resistance to infection (Bouley et al. 1984), and to increase mortality from virally-induced leukemia (Blakley 1986; Malave and de Ruffino 1984). Oral cadmium exposure has also been found to suppress the humoral immune response of mouse splenic cells to sheep red blood cell antigen in 6-week-old mice (Blakley 1985), but not in 12-month-old mice (Blakley 1988). The author suggests that “natural” age-related immune system dysfunction masked any cadmium suppressive effect in the 12-month-old mice, and that immunotoxicological investigations in aged models appear to be a poor indicator of immune response in the general population. Oral cadmium exposure has also been found to increase the cell-mediated immune response of monkeys (Chopra et al. 1984), to induce anti-nuclear antibodies in mice (Ohsawa et al. 1988), to increase circulating leukocytes in female rats (Borzelleca et al. 1989), and to exhibit time-dependent inhibitory and stimulative effects (Cifone et al. 1989b) or no effect (Stacey et al. 1988a) on natural killer cell activity in rats. The highest NOAEL values and all LOAEL values from each reliable study for immunological effects in each species and duration category are recorded in [Table 3-6](#) and plotted in [Figure 3-2](#).

3.2.2.4 Neurological Effects

A few studies have reported an association between environmental cadmium exposure and neuropsychological functioning. These studies used hair cadmium as an index of exposure (see Section 3.8.1 for a discussion of the limitations of using hair as an indicator of exposure). End points that were affected included verbal IQ in rural Maryland children (Thatcher et al. 1982), acting-out and distractibility in rural Wyoming children (Marlowe et al. 1985), and disruptive behavior in Navy recruits (Struempfer et al. 1985). The usefulness of the data from these studies is limited because of the potential confounding

3. HEALTH EFFECTS

effects of lead exposure; lack of control for other possible confounders including home environment, caregiving, and parental IQ levels; and an inadequate quantification of cadmium exposure.

Although cadmium-induced neurotoxicity has not been clearly demonstrated in human studies, it has been observed in animal studies. Both a single oral exposure (Kotsonis and Klaassen 1977) and intermediate-duration exposure of adult rats to cadmium resulted in significantly decreased motor activity (Kotsonis and Klaassen 1978; Nation et al. 1990). Intermediate-duration oral exposure to cadmium has also been reported to cause weakness and muscle atrophy (Sato et al. 1978), induce aggressive behavior (Baranski and Sitarek 1987), induce anxiety as manifested by increased passive avoidance behavior (Nation et al. 1984) and by increased ethanol consumption (Nation et al. 1989), and alter brain biogenic amine content and enzyme activities (Murthy et al. 1989). Doses associated with these effects range from 5 to 40 mg/kg/day cadmium. Degenerative changes in the choroid plexus have been reported in mice exposed to 1.4 mg/kg/day cadmium in drinking water for 22 weeks (Valois and Webster 1989). Peripheral neuropathy has been reported in rats after a 31-month exposure to cadmium in drinking water (Sato et al. 1978). Neurological effects in offspring of animals orally exposed to cadmium during gestation are discussed in Section 3.2.2.5. The highest NOAEL values and all LOAEL values from each reliable study for neurological effects in each species and duration category are recorded in [Table 3-6](#) and plotted in [Figure 3-2](#).

3.2.2.5 Reproductive Effects

Several studies have examined the possible association between increased cadmium exposure and male reproductive toxicity; however, most studies focused on sex steroid hormone levels and the results appear to be inconsistent. Akinloye et al. (2006) found significant associations between increasing blood cadmium levels and increasing levels of serum luteinizing hormone, follicle stimulating hormone, prolactin, and testosterone among infertile men (sperm counts <20 million/cm³ or no spermatozoa in semen). A significant association between increased blood cadmium levels and increased serum testosterone was also found in a group of workers with slight to moderate lead exposure (Telišman et al. 2000); however, neither study controlled for smoking. A study by Jurasović et al. (2004) found significant associations between blood cadmium levels and increased serum estradiol, follicle stimulating hormone, and testosterone levels in infertile men after adjusting for age, smoking, alcohol consumption, and biomarkers of lead, copper, zinc, and selenium. In contrast, a study of Chinese men living in areas with high levels of cadmium in rice did not find significant correlations between urinary or blood cadmium levels and serum testosterone, follicle stimulating hormone, or luteinizing hormone levels after

3. HEALTH EFFECTS

adjusting for BMI, age, smoking, and alcohol consumption (Zeng et al. 2004a). However, they did find that the prevalence of abnormally elevated serum testosterone levels (>95th percentile for controls) increased with exposure to cadmium. Using NHANES III data, Menke et al. (2008) found significant associations between urinary cadmium levels and serum testosterone and estradiol levels, but the associations were no longer significant after adjusting from smoking status and serum cotinine levels. Differences in study populations (e.g., infertile men, background cadmium exposure, high cadmium dietary exposure) and confounding factors (e.g., smoking, lead exposure) limit the interpretation of these results.

Four studies examined the possible association between cadmium exposure and sperm quality. In infertile men, increasing serum cadmium levels were significantly associated with abnormal sperm morphology and decreased sperm counts, sperm motility, and sperm viability (Akinloye et al. 2006). Another study found significant associations between blood cadmium levels and abnormal sperm morphology and decreased sperm motility in workers with slight to moderate lead exposure (Telišman et al. 2000). As noted previously, neither study adjusted for smoking. No significant correlations between blood cadmium levels and sperm quality were observed in infertile men with or without adjustment for smoking (Jurasović et al. 2004). Similarly, no significant association between blood cadmium levels and abnormal semen parameters were observed in infertile men (Benoff et al. 2009), although seminal plasma cadmium levels were significantly negatively correlated with sperm concentration and sperm motility in whole semen. Among men exposed to high levels of environmental cadmium, blood cadmium levels were significantly higher in men with abnormal digital rectal examinations of the prostate and trend analysis showed a dose-response relationship between cadmium exposure and the prevalence of abnormal prostate specific antigen (Zeng et al. 2004b).

Data on possible reproductive toxicity of cadmium in women are limited to two studies examining the possible association between cadmium body burden and endometriosis and one study examining fecundability. Among infertile Japanese, no association between urinary cadmium levels and the risk of endometriosis was observed (Itoh et al. 2008). Jackson et al. (2008) found a significant association between blood cadmium levels and risk of endometriosis using NHANES 1999–2002 data. Blood cadmium levels were significantly higher among women with endometriosis as compared to women without endometriosis. When comparing participants with the highest tertile of blood cadmium (0.5–8.5 µg/L) with the lowest tertile (<0.3 µg/L), the multivariate (including lead and mercury blood levels, race/ethnicity, smoking status, age) adjusted odds ratio was 3.39 (95% CI of 1.37–8.40). No association between blood cadmium levels and risk of uterine myomas was found. The possible association between

3. HEALTH EFFECTS

elevated cadmium body burden and time to pregnancy was examined among 400 couples participating in the Longitudinal Investigation of Fertility and the Environment (LIFE) Study (Buck Louis et al. 2012). After adjusting for several variables (age, BMI, cotinine, parity, and serum lipids), female urine cadmium levels were associated with a reduction in the fecundability odds ratio (0.78; 95% CI of 0.63–0.97) (a fecundability odds ratio of <1 denotes a longer time to pregnancy).

A number of animal studies have shown adverse reproductive effects to male and female reproductive capacity from cadmium exposure. In male rats and mice, acute oral exposure to near-lethal (60–100 mg/kg) doses can cause testicular atrophy and necrosis (Andersen et al. 1988; Bomhard et al. 1987; Borzelleca et al. 1989), and concomitant decreased fertility (Kotsonis and Klaassen 1978). Lower-dose acute exposures of 25–50 mg/kg did not result in reproductive toxicity in male animals (Andersen et al. 1988; Bomhard et al. 1987; Dixon et al. 1976).

The following intermediate-duration dosing regimens resulted in neither testicular histopathologic lesions nor a decrease in male reproductive success: 0.25 mg Cd/kg/day via gavage for 10 weeks (Bomhard et al. 1987); 5 mg/kg/day via water for 30–90 days (Dixon et al. 1976); 2.5 mg/kg/day via food for 4 weeks (Groten et al. 1990); 8 mg/kg/day via water for 24 weeks (Kotsonis and Klaassen 1978); 3 mg/kg/day via food for 12 weeks (Loeser and Lorke 1977a, 1977b); 2.9 mg/kg/day via water for 14 weeks (Pleasants et al. 1992); and 4.64 mg/kg/day via water for 70–80 days (Zenick et al. 1982). Some dosing regimens have resulted in adverse reproductive effects. Male rats exposed to 8.58 mg Cd/kg/day in water for 10 weeks developed necrosis and atrophy of seminiferous tubule epithelium (Cha 1987). Rats exposed to 5.8 mg/kg/day via water for 14 weeks (Pleasants et al. 1992) or 11.6 mg/kg/day via water for 14 weeks (Pleasants et al. 1993) developed increased testes weight. Rats exposed to 12.9 mg/kg/day in water for 120 days developed significantly increased relative testis weight, decreased sperm count and motility, decreased seminiferous tubular diameter, and seminiferous tubular damage (pyknotic nuclei, multinucleated giant cells, interstitial edema, and dilated blood vessels) (Saxena et al. 1989). In a protocol designed to assess the effects of vitamins on cadmium toxicity, Pleasants et al. (1992, 1993) reported that vitamins A and D₃ reduced the amount of cadmium-related increase in testis weight. Bomhard et al. (1987) reported no histopathologic lesions (other than those found in control animals as part of aging) in testes of rats receiving 10 weekly doses of 5 mg Cd/kg and followed for up to 30 months.

Higher doses of cadmium were generally needed to elicit a reproductive toxic response in females compared to the males. Although a dose of 65.6 mg Cd/kg/day via gavage for 10 days was sufficient to produce testicular atrophy and loss of spermatogenic element in male rats, no effects were seen in female

3. HEALTH EFFECTS

rats up to 138 mg/kg/day (Borzelleca et al. 1989). Decreased percentage of fertilized females and percentage of pregnancies were reported at 61.32 mg Cd/kg/day via gavage for 10 days during gestation (Gd 6–15) (Machemer and Lorke 1981). No effect was seen at doses up to 18.39 mg/kg/day (Machemer and Lorke 1981). Baranski (1987) also reported no treatment related effects on number or percentage of females pregnant with 28.8 mg Cd/kg/day via gavage for gestation days (Gds) 1–20. Baranski and Sitarek (1987), however, administered 40 mg/kg by gavage 5 days/week for 14 weeks to female rats and observed a significant increased duration (twice as long) of the estrus cycle starting at 7–8 weeks and persisting to 14 weeks of exposure and the termination of the experiment. This adverse effect was not seen at 4 mg/kg (Baranski et al. 1983; Baranski and Sitarek 1987).

Petering et al. (1979) exposed female rats to either 2.61 mg/kg/day via drinking water for 60 days prior to gestation or during gestation, or 5.23 mg/kg/day via drinking water for 111 days including 90 days prior gestation plus 21 days during gestation. These doses had no significant effects compared with controls for the number of pups stillborn. Pond and Walker (1975) also observed no effects in females from a cadmium exposure of 19.7 mg/kg/day via food for 21–25 days, including Gd 1 through lactation day (Ld) 1, on number of pups born. No effects from a cadmium exposure on number of pups born to females were observed for an exposure of 8.2 mg/kg/day via food for 15 days, including Gd 6–20 (Sorell and Graziano 1990).

A dose of 10 mg Cd/kg/day once a day via gavage for 9 weeks (6 weeks prior to gestation and 3 weeks of gestation) significantly decreased the number of copulating and pregnant females, and the number of implants and live fetuses (Sutou et al. 1980). No effect was seen at 1 mg/kg/day (Sutou et al. 1980).

Reproductive effects on both male and female rats orally exposed to 2.5 mg/kg/day via drinking water for 180 days may have resulted in the observed decrease in litter size and increased interval between litters. Both males and females were treated over two generations. Three of five pairs failed to breed in the second generations (Schroeder and Mitchener 1971). No histopathologic lesions were found in testes or uteri of dogs given cadmium chloride at 0.75 mg/kg/day via food for 3 months (Loeser and Lorke 1977b).

Male rats were exposed to 0–14 mg Cd/kg/day via food for 77 weeks. The incidence of prostatic hyperplasias was increased above controls (1.8%) from the 3.5 mg Cd/kg/day dose. The overall incidence for prostatic lesions for all cadmium-treated groups was much lower in zinc-deficient rats, possibly because of a marked increase in prostatic atrophy that was associated with reduced zinc intake. Moreover, there was not a clear dose-response increase in prostatic proliferative lesions. Testicular

3. HEALTH EFFECTS

tumors (exclusively benign interstitial tumors) increased significantly only at the highest-dose cadmium with diets adequate in zinc. Male Wistar rats exposed to cadmium in the drinking water at 0, 25, 50, 100, or 200 ppm developed tumors of the prostate (50 ppm), testes (200 ppm), and hematopoietic system (50 ppm), while dietary zinc deficiency has complex, apparently inhibitory effects on cadmium carcinogenesis by this route (Waalkes and Rehm 1992).

The highest NOAEL values and all LOAEL values from each reliable study for reproductive effects in each species and duration category are recorded in [Table 3-6](#) and plotted in [Figure 3-2](#).

3.2.2.6 Developmental Effects

There are very limited data on the developmental effects of cadmium in humans. Several studies have examined the possible relationship between maternal cadmium levels and newborn size. No significant association between maternal blood cadmium levels and newborn body weight were observed in women with mean blood cadmium levels of 0.7 µg/L (Mokhtar et al. 2002), 1.04 µg/L (Nishijo et al. 2004b), 1.4 µg/L (Galicía-García et al. 1997), or 1.72 µg/L (Zhang et al. 2004) or urinary cadmium levels of >2 nmol/mmol creatinine (Nishijo et al. 2002); the Nishijo et al. (2002, 2004b), and Zhang et al. (2004) studies used statistical adjustments for maternal age, maternal size, and/or gestation age. Two studies found an association between cord blood cadmium levels and decreasing birthweight (Galicía-García et al. 1997; Salpietro et al. 2002); however, the association was only statistically significant in the Salpietro et al. (2002) study. A significant association between newborn height and maternal blood cadmium levels was observed in women with a mean blood cadmium level of 9.29 nmol/L (Nishijo et al. 2004b); other studies have not found this association (Mokhtar et al. 2002; Nishijo et al. 2002; Zhang et al. 2004). Nishijo et al. (2002) found a significant negative correlation between maternal urinary cadmium levels and gestation length; Mokhtar et al. (2002) did not find a significant association between maternal blood cadmium levels and gestation length.

Urinary cadmium content was measured in women 3 days after giving birth and compared to smoking habits and birth weight of offspring. Among nonsmoking women, when cadmium content was expressed as µg/L, cadmium levels were higher in women with infants of below-normal birth weight. However, when cadmium content was expressed as µg/g creatinine, cadmium levels were lower in women with infants with below-normal birth weight. Cadmium levels in smoking women were lower in both µg/L and µg/g in women with infants with below-normal birth weight (Cresta et al. 1989).

3. HEALTH EFFECTS

Cao et al. (2009) examined the possible association between postnatal exposure to cadmium (as measured by blood cadmium) and neurodevelopment in children participating in the Treatment of Lead-Exposed Children trial. Blood cadmium levels in the children were comparable to levels in the NHANES 2005–2006 survey, and blood lead levels were between 20 and 44 $\mu\text{g}/\text{dL}$ at referral. No significant associations (after adjustment for multiple variables including parent's education, gender, and concurrent blood lead levels) between blood cadmium levels and scores on neuropsychological and behavioral tests were found in children evaluated at age 5 and 7 years or IQ evaluated at 2, 5, and 7 years of age.

A number of studies in rats and mice indicate that cadmium can be fetotoxic from oral exposures prior to and during gestation. This fetotoxicity is most often manifested as reduced fetal or pup weights (Ali et al. 1986; Baranski 1987; Gupta et al. 1993; Kelman et al. 1978; Kostial et al. 1993; Petering et al. 1979; Pond and Walker 1975; Sorell and Graziano 1990; Sutou et al. 1980; Webster 1978; Whelton et al. 1988), but malformations, primarily of the skeleton, have been found in some studies (Baranski 1985; Machemer and Lorke 1981; Schroeder and Mitchener 1971). Malformations or skeletal effects reported include sirenomelia (fused lower limbs), amelia (absence of one or more limbs), and delayed ossification of the sternum and ribs (Baranski 1985); dysplasia of facial bones and rear limbs, edema, exenteration, cryptorchism, and palatoschisis (Machemer and Lorke 1981); and sharp angulation of the distal third of the tail (Schroeder and Mitchener 1971). Dosing levels were in the 1–20 mg/kg/day range.

The most sensitive indicator of developmental toxicity of cadmium in animals appears to be neuro-behavioral development. Offspring of female rats orally exposed to cadmium at a dose of 0.04 mg/kg/day prior to and during gestation had reduced exploratory locomotor activity and rotorod performance at age 2 months (Baranski et al. 1983). Pups from dams exposed to 0.7 mg/kg/day during gestation had significant delays in cliff aversion and swimming behavior. Locomotor activity was significantly increased. In post-weaning measurements, locomotor activity was significantly decreased in treated groups at 60 days of age; conditioned avoidance behavior was also significantly decreased when tested at 60 and 90 days of age (Ali et al. 1986).

Nagymajtenyi et al. (1997) also reported behavioral and functional neurotoxicological changes caused by cadmium in a three-generational study in rats. Three consecutive generations of Wistar rats were orally treated by gavage with 3.5, 7.0, or 14.0 mg Cd/kg bw (as cadmium chloride diluted in distilled water) over the period of pregnancy, lactation, and 8 weeks after weaning. Behavioral (open field behavior) and electrophysiological (spontaneous and evoked cortical activity, etc.) parameters of male rats from each generation were investigated at the age of 12 weeks. The main behavioral outcomes were increased

3. HEALTH EFFECTS

vertical exploration activity (rearing) and increased exploration of an open-field center. The spontaneous and evoked electrophysiological variables showed dose- and generation-dependent changes (increased frequencies in the electrocorticogram, lengthened latency and duration of evoked potentials, etc.) signaling a change in neural functions. The results indicate that low-level, multigeneration exposure of rats to inorganic cadmium can affect nervous system function.

Desi et al. (1998) continued the above studies to further evaluate cadmium associated changes in behavior and neurological function in rats following different dosage regimens during pregnancy. Female Wistar rats were given 3.5, 7.0, or 14.0 mg Cd/kg body weight (cadmium chloride dissolved in distilled water) in three different treatment regimes: days 5–15 of pregnancy; days 5–15 of pregnancy + 4 weeks of lactation; and days 5–15 of pregnancy + 4 weeks of lactation followed by the same oral treatment of male rats of the F₁ generation for 8 weeks. The behavioral (open-field exploration) and electrophysiological (electrocorticogram, cortical-evoked potentials, conduction velocity and refractory periods of a peripheral nerve) parameters of F₁ male rats exposed by various treatments were investigated at the age of 12 weeks. The results indicate that cadmium altered the spontaneous and evoked electrophysiological functions (e.g., increased the frequency of the electrocorticogram, lengthened the latency and duration of evoked potentials, etc.) in a dose- and duration-dependent manner. Only combining treatment during the prenatal development and the 4-week suckling period resulted in a significant dose-dependent decrease of horizontal and vertical exploratory activity and a significantly lower exploration frequency of the open-field center. The results suggest that low-level pre- and postnatal inorganic cadmium exposure affects the electrophysiological and higher order functions of the nervous system.

Neurochemical alterations have also been observed in the offspring of rats administered cadmium acetate in drinking water during gestation (1.12 mg Cd/kg/day) and lactation (2.41 mg Cd/kg/day) (Antonio et al. 2010). The alterations included decreased serotonin in dorsal hippocampus and dihydroxyphenylacetic acid in brain cortex and rostral neostriatum and increased 5-hydroxyindolacetic acid in dorsal hippocampus and brain cortex and glutamate in the dorsal hippocampus.

A study by Gupta et al. (1993) examined the developmental profiles of DNA, RNA, proteins, DNA synthesis, thymidine kinase activity, and concentrations of zinc and cadmium in the brain of neonates from dams exposed to cadmium acetate at 5–6.3 mg/kg/day in drinking water during gestation, and 7–8 mg/kg/day during a 21-day lactation period. Pup brain and body weights were significantly decreased in the cadmium exposed pups on Ld 7–21. Cadmium brain accumulation was significantly increased in exposed pups on Ld 7 and remained at similar levels on Ld 14 and 21. DNA and thymidine kinase brain

3. HEALTH EFFECTS

levels were significantly decreased in treated pups compared with controls on Ld 7, 14, and 21. The toxicological significance of changes in DNA incorporation and thymidine kinase activity are uncertain.

Xu et al. (1993b) determined lipid peroxide (LPO) concentrations in rat pups in various organs as an index of cadmium toxicity. Male and female Wistar mice were exposed to cadmium in drinking water at 0, 5.7, or 14.25 mg/kg/day for 2 months prior to mating. The pregnant females continued to be exposed during gestation and lactation. Litter size and pup survival rates were unaffected by cadmium. Body weights were not statistically different between the exposed and control groups. In pups, brain weights (at 5.7 and 14.25 mg/kg/day) and liver, kidney, and heart weights (at 14.25 mg/kg/day) were significantly decreased. Although the relative organ weights were lower in the high-dose group, the difference from controls was not statistically significant. LPO concentrations in all organs were significantly increased in pups on Ld 7 at 14.25 mg/kg/day except in the kidney; concentrations in the liver, heart, and brain were 131.5, 156, and 237.4%, respectively, of the concentrations in controls.

In contrast to most of the study results, Saxena et al. (1986) reported no developmental effects from an exposure to 21 mg Cd/kg/day via drinking water during gestation (Gd 0–20). This study evaluated simultaneous exposure to lindane (20 mg lindane/kg via gavage on Gd 6–14) and cadmium acetate in drinking water at doses that individually did not cause maternal or developmental effects. Maternal toxicity (significantly decreased weight gain) and developmental toxicity were only observed in the cadmium plus lindane group. Fetal body weight was significantly decreased; intrauterine death and the rate of skeletal anomalies were significantly increased. Anomalies consisted of decreased ossification, wavy ribs, and scrambled sternbrae.

The highest NOAEL values and all LOAEL values from each reliable study for developmental effects in each species and duration category are recorded in [Table 3-6](#) and plotted in [Figure 3-2](#).

3.2.2.7 Cancer

Epidemiology studies have examined the possible association between exposure to elevated levels of cadmium and overall cancer rates or specific cancer rates. Older studies have examined cancer rates among residents of cadmium polluted areas but did not estimate cadmium exposure levels. No significant increase in cancer rates was found among residents of a cadmium-polluted village in England (Inskip et al. 1982) or in prostate, kidney, or urinary tract cancer among residents of a cadmium-polluted area of Belgium (Lauwerys and De Wals 1981). Another study found that the geographic distribution of elevated

3. HEALTH EFFECTS

rates of prostate cancer incidence paralleled the distribution of elevated cadmium concentrations in water, soil, or grain crops in Alberta, Canada (Bako et al. 1982). In a retrospective mortality study of residents of three areas of Japan classified on the basis of rice cadmium content as highly polluted, slightly polluted, or nonpolluted, no significant differences were found in mortality from cancer of all sites including prostate cancer (Shigematsu 1984). Inhabitants of cadmium-polluted areas of Japan with elevated urinary retinol binding protein excretion had a mortality rate from malignant neoplasms no different from expected (Nakagawa et al. 1987).

Three more recent studies of populations living in cadmium-polluted areas have used blood or urine to examine dose-response relationships for carcinogenic risk. Among residents living in a cadmium-polluted area of China, significantly higher blood cadmium levels were observed in subjects with suspected prostate cancer (based on digital rectal examination) as compared to subjects with normal digital rectal examination results (Zeng et al. 2004); there were no significant differences in urinary cadmium levels. However, a significant trend was found for the number of cases with positive prostate-specific antigen levels and urinary cadmium levels. In a study of residents living in an area of Japan that previously had high levels of cadmium contamination, a significant increase in cancer mortality was observed among subjects with urinary β 2-microglobulin levels of $\geq 1,000$ $\mu\text{g/g}$ creatinine (Arisawa et al. 2001); however, no increases in cancer incidence were observed in exposed subjects or in subjects with elevated urinary β 2-microglobulin, urinary cadmium, or blood cadmium levels. In a follow-up study that extended the observation period from 15 to 23 years, no alterations in cancer mortality or cancer incidence were observed in the exposed population as compared to referent populations (Arisawa et al. 2007b). However, when the subjects were divided into two groups based on urinary β 2-microglobulin levels, the relative risk of cancer deaths in males and females with β 2-microglobulin levels of $\geq 1,000$ $\mu\text{g/g}$ creatinine was 2.58 (95% CI of 1.25–5.36) compared to residents with urinary β 2-microglobulin levels of $< 1,000$ $\mu\text{g/g}$ creatinine.

Several case-control studies have examined the possible association between cadmium body burden and increased risk of cancer among the general populations. In a study conducted in Belgium, a significant relationship between bladder cancer and blood cadmium levels was reported (Kellen et al. 2007). After adjustment for age, gender, occupational exposure to polyaromatic hydrocarbons or aromatic amines, and smoking, the odds ratio was 5.7 (95% CI of 3.3–9.9) when comparing the risk of bladder cancer for subjects in the highest blood cadmium tertile to those in the lowest tertile. Another case-control study examined the possible relationship between urinary cadmium levels and breast cancer risk in the United States (McElroy et al. 2006). The breast cancer risk (after adjustment for a number of variables including

3. HEALTH EFFECTS

age, parity, family history of breast cancer and BMI) in women with urinary cadmium levels in the highest quartile was 2.29 (95% CI of 1.3–4.2) as compared to women in the lowest quartile; the investigators noted that adjusting for smoking status did not change the risk estimate. Similarly, a significant increase in the risk of breast cancer was observed among women living in Long Island, New York with urinary cadmium levels $>0.60 \mu\text{g cadmium/g creatinine}$, as compared to women with urinary cadmium levels of $<0.22 \mu\text{g cadmium/g creatinine}$ after controlling for age, menopausal status, smoking and alcohol use, and family history (Gallagher et al. 2010). Another study of residents of the East Nile Delta region in Egypt with pancreatic cancer found a significant association between pancreatic cancer risk and serum cadmium levels; the odds ratio was 1.12 (95% CI of 1.04–1.23) (Kriegel et al. 2005). The study also found a significant association between farming and risk of pancreatic cancer. The results of this study should be interpreted cautiously since the study did not adjust for smoking status or farming occupation.

In a Swedish population-based study of postmenopausal women, an increased risk of endometrial cancer was found in women with elevated cadmium intake (Åkesson et al. 2008). Among women who never smoked, did not use postmenopausal hormones, had a BMI of $<27 \text{ kg/m}^2$, and consistently had a cadmium intake above the median intake for the study, the relative risk of endometrial cancer was 2.86 (95% CI of 1.05–7.79).

One study examined cadmium, zinc, and copper in human kidney tumors and normal kidneys. Kidneys with renal cell carcinoma in cortex from 31 cases (20 men and 11 women) were compared to kidneys of patients who had died from causes other than a malignant disease from 17 controls (9 men and 8 women). No patients in this study had been occupationally exposed. Smoking habits for patients were recorded. The level of cadmium in tumor tissue did not correlate with cadmium in cortex or medulla in the same kidney. No significant difference was found between cases and controls, although smoking cases had higher levels of cadmium. It was concluded that cadmium was not a risk factor for renal cell carcinoma (Hardell et al. 1994).

In rats and mice, earlier studies on chronic oral exposure to cadmium did not report an increased overall cancer incidence or the incidence of specific tumor types (Kanisawa and Schroeder 1969; Levy and Clack 1975; Levy et al. 1975; Löser 1980; Mangler et al. 1988; Schroeder et al. 1964, 1965). However, maximum daily doses tested were only 1 mg/kg/day in mice (Schroeder et al. 1964) and 3.5 mg/kg/day in rats (Löser 1980) and, in most of these studies, histopathologic examination was limited compared to contemporary standards. Löser (1980) did perform a relatively thorough histological examination. A few

3. HEALTH EFFECTS

additional animal studies of noncancer effects of chronic-duration oral cadmium exposure have indicated that no dose-related increases in tumors were found at maximum doses of 4.01 mg/kg/day in rats (Fingerle et al. 1982) or 8 mg/kg/day in mice (Watanabe et al. 1986).

Waalkes and Rehm (1992) evaluated the effects of chronic dietary zinc deficiency on oral cadmium carcinogenesis in male Wistar rats. Rats were exposed for 77 weeks to cadmium at 0, 1.75, 3.5, 7.0, or 14.0 mg cadmium/kg/day as cadmium chloride in a diet containing an adequate or a deficient amount of zinc. A significant increase in the incidence of proliferative lesions (hyperplasia and adenomas) was observed in the prostate of rats exposed to 1.75 mg cadmium/kg/day in the zinc-adequate (22.7%) or zinc-deficient (15.4%) groups, as compared to controls (1.9%). However, the incidences of prostatic lesions were not significantly increased in rats exposed to higher cadmium doses. The incidence of large granular lymphocyte leukemia was significantly increased in rats fed the zinc-adequate diet with 3.5 or 7.0 mg cadmium/kg/day, but not at 14.0 mg cadmium/kg/day; however, an increased incidence was observed at 14.0 mg cadmium/kg/day in the zinc-deficient rats. Exposure to 14.0 mg cadmium/kg/day also resulted in a significant increase in interstitial cell tumors of the testes in the group fed a zinc-adequate diet. The results of the study suggest that dietary zinc deficiency may inhibit the carcinogenic potential of cadmium, but additional research is needed.

A subsequent study by Waalkes et al. (1993) using male B6C3F1 mice evaluated the effects of cadmium exposure on tumor incidence at various times after the initiation of the carcinogenic process. The possible role of metallothionein in the susceptibility of transformed cells to cadmium cytotoxicity was also evaluated. At 5 weeks of age, mice received an intraperitoneal injection of *N*-nitrosodiethylamine (NDEA) at 90 mg/kg. At 2, 4, 8, 16, or 32 weeks post-NDEA injection, mice received water containing 1,000 ppm cadmium *ad libitum* for up to 48 weeks of post-NDEA exposure. Cadmium exposure caused a marked "reduction" in liver tumor incidence in NDEA-treated mice even when given as late as 32 weeks after the initial NDEA treatment. Cadmium alone eliminated the spontaneously occurring incidence of liver tumors (i.e., 0 of 25 compared with 5 of 25 in the controls). Liver tumors produced by NDEA were typically basophilic adenomas. Cadmium resulted in a modest reduction in lung tumor incidence, statistically significant (28% reduction) only for the 16–48-week cadmium-treated group pretreated with NDEA. Lung tumors were typically adenomas of alveolar cell origin. Cadmium alone eliminated spontaneously occurring lung tumors compared with the controls. Cadmium significantly reduced the multiplicity of tumors induced by NDEA. NDEA alone typically induced seven tumors per lung, while NDEA plus cadmium treatment reduced the number of tumors to 2.5–3.5 (data taken from a graph) with some cases showing an 80% reduction in tumor numbers. Lung tumors found in the cadmium plus

3. HEALTH EFFECTS

NDEA-treatment groups were also smaller in overall size than those found in the NDEA-only treatment groups. Relatively little metallothionein was present in liver carcinomas, liver adenomas, and lung adenomas as indicated by immunohistochemistry. This finding was confirmed biochemically for the liver tumors. The authors concluded that cadmium can effectively “impair” tumor formation in the lungs and liver of male B6C3F1 mice and that cadmium appears to be able to selectively destroy existing preneoplastic and/or tumor cells (adenomas). The mechanism may involve a reduced activity and responsiveness of the metallothionein system in transformed liver cells.

A two-stage initiation/promotion experiment evaluated the promoting effects of cadmium chloride in the drinking water in rats. Cadmium exposure resulted in the following alterations in tumorigenic outcome: in the liver, hepatocellular carcinomas (initiated with diethyl nitrosamine) were decreased; in the stomach, tumors (initiated with *N*-methyl-*N'*-nitro-nitrosoguanidine plus NaCl at 10% in the diet) were not affected; in the kidney, tumors (initiated with *N*-ethyl-*N*-hydroxyethyl nitrosamine) showed increased dysplastic foci but no increase in renal cell tumors; in the pancreas, tumors (initiated with *N*-nitrosobis [2-oxopropyl] amine) had a nonsignificant increase in adenocarcinomas (female hamster study); and in the skin (initiated with 7,12-dimethyl benz(a)anthracene), there was no effect (female SENCAR mouse study) (Kurokawa et al. 1989).

3.2.3 Dermal Exposure

3.2.3.1 Death

No studies were located regarding death in humans after dermal exposure to cadmium.

Some guinea pigs died 2 or 6 weeks after being exposed in a skin depot (3.1 cm²) to 2 mL of 0.239 molar aqueous of cadmium chloride (0.14 mg/kg body weight) (Wahlberg 1965). However, it is difficult to attribute these deaths to cadmium exposure, due to the low dose compared to oral LD₅₀ values and to the fact that no necropsy was done to determine whether the exposed guinea pigs might have died from pneumonia (which killed some control guinea pigs) (Wahlberg 1965).

3.2.3.2 Systemic Effects

No studies were located regarding respiratory, cardiovascular, gastrointestinal, hematological, musculoskeletal, hepatic, or renal effects in humans or animals after dermal exposure to cadmium.

3. HEALTH EFFECTS

Dermal Effects. Among eczema patients routinely patch-tested with 2% cadmium chloride, 25 out of 1,502 showed some reaction (Wahlberg 1977). Since no reaction was found at lower dilutions in reactive patients (Wahlberg 1977), the effect was likely direct irritation of the skin and is indicated as a LOAEL value in [Table 3-9](#).

No studies were located regarding dermal effects in animals after dermal exposure to cadmium.

Ocular Effects. No studies were located regarding ocular effects in humans after dermal exposure to cadmium.

Rats exposed to high concentrations of cadmium pigments or cadmium oxide in air had excessive lacrimation four hours after exposure (Rusch et al. 1986), possibly due to a direct irritation effect on the eyes.

3.2.3.3 Immunological and Lymphoreticular Effects

Dermal exposure to cadmium does not appear to affect the immune system significantly. One report of workers with extensive exposure to cadmium dust reported an increase in complaints of eczema (Friberg 1950); however, no subsequent studies have confirmed any association. Routine patch tests among dermatitis and eczema patients using up to 2% cadmium chloride solutions have found skin irritation at 2%, but no evidence of allergic reactions at a dose of 1% among people without known prior cadmium exposure (Rudzki et al. 1988; Wahlberg 1977) or among workers occupationally exposed to cadmium (Rudzki et al. 1988). Individuals with yellow tattoos containing cadmium sulfide often experience swelling of the surrounding skin on exposure to ultra violet (UV) irradiation (Bjornberg 1963); however, this may be the result of dermal damage from the photoconductivity of cadmium sulfide rather than a direct immunological reaction.

Guinea pigs showed no contact sensitization following intradermal or topical exposure to cadmium chloride at concentrations up to 0.5% (Wahlberg and Boman 1979). The NOAEL values from each reliable study for immunological effects in each species and duration category are recorded in [Table 3-9](#).

Table 3-9 Levels of Significant Exposure to Cadmium - Dermal

Species (Strain)	Exposure/Duration/Frequency (Route)	System	LOAEL				Reference Chemical Form	Comments
			NOAEL	Less Serious		Serious		
ACUTE EXPOSURE								
Systemic								
Human	once	Dermal	1 Percent (%)	2 Percent (%)	(skin irritation)		Wahlberg 1977 CdCl ₂	
Rat (Sprague-Dawley)	2 hr	Ocular		99 mg/m ³	(excessive lacrimation)	112 mg/m ³	(eyes closed from exposure)	Rusch et al. 1986 CdSeS
				97 mg/m ³	(excessive lacrimation)			
Immuno/ Lymphoret								
Human	once		1 Percent (%)				Rudzki et al. 1988 CdCl ₂	

hr = hour(s); Immuno/Lymphoret = immunological/lymphoreticular; LOAEL = lowest-observed-adverse-effect level; NOAEL = no-observed-adverse-effect level

3. HEALTH EFFECTS

No studies were located regarding the following health effects in humans or animals after dermal exposure to cadmium:

3.2.3.4 Neurological Effects

3.2.3.5 Reproductive Effects

3.2.3.6 Developmental Effects

3.2.3.7 Cancer

3.3 GENOTOXICITY

The genotoxic potential of cadmium has been studied in *in vivo* studies of cadmium workers, members of the general population, and rodents as summarized in [Table 3-10](#). Although not always consistent, these results suggest that cadmium is a clastogenic agent, as judged by the induction of DNA damage, micronuclei, sister chromatid exchange (SCE), and chromosomal aberrations.

Palus et al. (2003) examined peripheral lymphocytes from workers occupationally exposed to cadmium and found statistically significant increases compared to the control population in micronuclei rates and sister chromatid exchanges as well as evidence of an increased incidence of leukocytes with DNA fragmentation. Examination of lymphocytes and leukocytes from workers occupationally exposed to cadmium and lead or to cadmium, lead, and zinc showed increased frequency of chromosomal aberrations compared to control groups (Abraham et al. 2011; Bauchinger et al. 1976; Deknudt and Leonard 1975; Deknudt et al. 1973), but this effect was not observed in men exposed primarily to cadmium (Bui et al. 1975; O'Riordan et al. 1978). Human lymphocytes from individuals inhabiting cadmium-polluted areas of China have been found to have increased micronuclei rates and a higher frequency of chromosomal aberrations and severe aberration types, in comparison to control populations with either no known exposure to cadmium or low-level exposure (Fu et al. 1999; Tang et al. 1990). Bui et al. (1975) examined blood samples from four female Japanese patients with Itai-Itai disease and found no evidence to indicate that cadmium is capable of inducing chromosomal damage.

For the most part, cadmium exposure via inhalation (Valverde et al. 2000), oral (Devi et al. 2001; Kasuba et al. 2002), and parenteral (Fahmy and Aly 2000; Kasuba et al. 2002; Mukherjee et al. 1988a; Saplakoglu et al. 1997; Wronska-Nofer et al. 1999; Zhou et al. 2004b) routes has been shown to be associated with DNA damage and induction of micronuclei in rodent cells.

3. HEALTH EFFECTS

Table 3-10. Genotoxicity of Cadmium *In Vivo*

Species (test system)	End point	Results	Reference
Mammalian cells:			
Inhalation exposure:			
Human lymphocytes	Chromosomal aberrations	+	Deknudt et al. 1973
Human lymphocytes	Chromosomal aberrations	–	Bui et al. 1975
Human lymphocytes	Chromosomal aberrations	+	Deknudt and Leonard 1975
Human lymphocytes	Chromosomal aberrations	+	Bauchinger et al. 1976
Human lymphocytes	Chromosomal aberrations	–	O’Riordan et al. 1978
Human lymphocytes	Chromosomal aberrations	+	Alessio et al. 1993
Human lymphocytes	Chromosomal aberrations	+	Abraham et al. 2011
Human lymphocytes	Sister chromatid exchanges	+	Abraham et al. 2011
Human lymphocytes	Sister chromatid exchanges	+	Palus et al. 2003
Human lymphocytes	Micronuclei	+	Palus et al. 2003
Human lymphocytes	DNA damage	+	Palus et al. 2003
Mouse bone marrow	DNA damage	+	Valverde et al. 2000
Mouse brain cells	DNA damage	+	Valverde et al. 2000
Mouse testicular cells	DNA damage	+	Valverde et al. 2000
Mouse liver cells	DNA damage	+	Valverde et al. 2000
Mouse kidney cells	DNA damage	+	Valverde et al. 2000
Mouse lung cells	DNA damage	+	Valverde et al. 2000
Mouse nasal epithelial cells	DNA damage	+	Valverde et al. 2000
Oral exposure:			
Rat bone cells	Altered gene expression	+	Ohba et al. 2007
Mouse bone marrow	Chromosomal aberrations	–	Deknudt and Gerber 1979
Mouse bone marrow	Chromosomal aberrations	+	Mukherjee et al. 1988b
Rat bone marrow	Chromosomal aberrations	–	Desi et al. 2000
Human leukocytes	Chromosomal aberrations	+	Shiraishi and Yoshida 1972
Human lymphocytes	Chromosomal aberrations	–	Bui et al. 1975
Human lymphocytes	Chromosomal aberrations	+	Tang et al. 1990
Human lymphocytes	Chromosomal aberrations	+	Fu et al. 1999
Mouse leukocytes	DNA damage	+	Devi et al. 2001
Rat lymphocytes	DNA damage	+	Kasuba et al. 2002
Rat spermatogenesis	Dominant lethal mutations	–	Sutou et al. 1980
Rat spermatogenesis	Dominant lethal mutations	–	Zenick et al. 1982
Rat lymphocytes	Micronuclei	+	Kasuba et al. 2002
Human lymphocytes	Micronuclei	+	Fu et al. 1999
Intraperitoneal exposure:			
Mouse oocytes	Aneuploidy	–	Mailhes et al. 1988
Mouse spermatocytes	Chromosomal aberrations	+	Selypes et al. 1992

3. HEALTH EFFECTS

Table 3-10. Genotoxicity of Cadmium *In Vivo*

Species (test system)	End point	Results	Reference
Mouse bone marrow	Chromosomal aberrations	+	Fahmy and Aly 2000
Mouse spermatocytes	Chromosomal aberrations	+	Fahmy and Aly 2000
Mouse bone marrow	Chromosomal aberrations	–	Bruce and Heddle 1979
Mouse bone marrow	Chromosomal aberrations	+	Mukherjee et al. 1988a
Mouse spermatocytes	Chromosomal translocations	–	Gilliavod and Leonard 1975
Rat lung cells	DNA strand breaks	+	Saplakoglu et al. 1997
Rat kidney cells	DNA strand breaks	+	Saplakoglu et al. 1997
Rat liver cells	DNA strand breaks	–	Saplakoglu et al. 1997
Mouse spermatogenesis	Dominant lethal mutations	–	Epstein et al. 1972
Mouse spermatogenesis	Dominant lethal mutations	–	Gilliavod and Leonard 1975
Mouse oocytes	Dominant lethal mutations	–	Suter 1975
Rat lymphocytes hprt locus	Gene mutation	±	Jianhua et al. 2006
Mouse bone marrow	Micronuclei	±	Mukherjee et al. 1988a
Mouse bone marrow	Micronuclei	+	Wronska-Nofer et al. 1999
Mouse bone marrow	Micronuclei	+	Fahmy and Aly 2000
Mouse bone marrow	Sister chromatid exchanges	+	Mukherjee et al. 1988a
Mouse bone marrow	Sister chromatid exchanges	+	Fahmy and Aly 2000
Mouse spermatozoa	Sperm morphology	–	Bruce and Heddle 1979
Mouse spermatozoa	Sperm morphology	+	Mukherjee et al. 1988a
Syrian hamster embryo cells	Transformation	+	DiPaulo and Castro 1979
Subcutaneous exposure:			
Mouse testicular cells	Altered gene expression	+	Zhou et al. 2004b
Mouse blastocysts	Aneuploidy	+	Watanabe and Endo 1982
Syrian hamster oocytes	Aneuploidy	+	Watanabe et al. 1979
Mouse bone marrow	Chromosomal aberrations	+	Karmakar et al. 1998
Mouse testicular cells	DNA damage	–	Zhou et al. 2004b
Rat lymphocytes	DNA damage	+	Kasuba et al. 2002
Rat lymphocytes	Micronuclei	+	Kasuba et al. 2002
Mouse bone marrow	Sister chromatid exchanges	–	Nayak et al. 1989
Mouse fetal liver and lung cells	Sister chromatid exchanges	–	Nayak et al. 1989

– = negative result; + = positive result; ± = weakly positive result; DNA = deoxyribonucleic acid

3. HEALTH EFFECTS

Evidence of the potential for cadmium to induce SCE (Fahmy and Aly 2000; Mukherjee et al. 1988a; Nayak et al. 1989) and chromosomal aberrations (Bruce and Heddle 1979; Desi et al. 2000; DiPaulo and Castro 1979; Fahmy and Aly 2000; Karmakar et al. 1998; Mukherjee et al. 1988a; Tang et al. 1990; Watanabe et al. 1979) is mixed. Data regarding the aneugenic potential of cadmium are limited and also conflicting. Watanabe and Endo (1982) observed an increased incidence of mouse blastocysts with trisomies and triploidies from female mice treated subcutaneously with cadmium compared to control mice. Watanabe et al. (1979) reported that subcutaneous exposure to cadmium induced mutagenicity in hamster oocytes, and in particular, induced the production of diploid oocytes. However, Mailhes et al. (1988) did not observe an increased incidence of hyperploid oocytes in female mice treated with cadmium via intraperitoneal injection.

No evidence for germ cell mutations (the dominant lethal test) has been observed in male rats orally exposed to cadmium (Sutou et al. 1980; Zenick et al. 1982) or in mice exposed to cadmium via inhalation (Gilliavod and Leonard 1975; Suter 1975) or intraperitoneal exposure (Epstein et al. 1972). However, chromosomal aberrations in mouse spermatocytes and Syrian hamster oocytes (Fahmy and Aly 2000; Selypes et al. 1992; Watanabe et al. 1979) and altered gene expression in mouse testicular cells (Zhou et al. 2004b) have been observed following cadmium exposure.

Data based on *in vitro* examination of the genotoxic effects of cadmium in microorganisms, yeast, insects, and mammalian cells are summarized in [Table 3-11](#). For the most part, *in vitro* data support the *in vivo* data suggesting that cadmium has the potential to induce DNA damage, micronuclei, chromosomal aberrations, and genetic mutations.

In vitro studies have shown that cadmium induces genetic mutations in hamster and mouse cells (Amacher and Paillet 1980; Filipic and Hei 2004; Honma et al. 1999; Jianhua et al. 2006; Oberly et al. 1982), transformation in rodent cells (Casto et al. 1979; Terracio and Nachtigal 1988), unscheduled DNA synthesis in rat cells (Denizeau and Marion 1989), DNA breaks in human cells (Depault et al. 2006; Lopez-Ortal et al. 1999; Mikhailova et al. 1997), DNA lesions in hamster cells (Jianhua et al. 2006), and inhibits DNA repair in human and hamster cells (Lutzen et al. 2004; Lynn et al. 1997). Misra et al. (1998) did not observe DNA damage in rat cells following treatment with cadmium, but DNA damage has been noted in human cells (Fatur et al. 2002; Rozgaj et al. 2002).

Chromosomal aberrations following cadmium exposure have been observed in Chinese hamster ovary cells (Cai and Arenaz 1998; Deaven and Campbell 1980; Rohr and Bauchinger 1976), but studies on

3. HEALTH EFFECTS

Table 3-11. Genotoxicity of Cadmium *In Vitro*

Species (test system)	End point	Results		Reference
		With activation	Without activation	
Prokaryotic organisms:				
<i>Bacillus subtilis</i>	DNA repair	No data	±	Nishioka 1975
<i>B. subtilis</i>	DNA repair	No data	±	Kanematsu et al. 1980
<i>Salmonella typhimurium</i> (plate incorporation)	Gene mutation	–	–	Bruce and Heddle 1979
<i>S. typhimurium</i> (liquid suspension)	Gene mutation	–	–	Milvy and Kay 1978
<i>S. typhimurium</i> (liquid suspension)	Gene mutation	No data	±	Mandel and Ryser 1984
<i>S. typhimurium</i> (plate incorporation)	Gene mutation	–	+	Wong 1988
Eukaryotic organisms:				
Yeast:				
<i>Saccharomyces cerevisiae</i>	Gene mutation	No data	+	Putrament et al. 1977
<i>S. cerevisiae</i>	Intrachromosomal recombination	No data	+	Schiestl et al. 1989
Insects:				
<i>Drosophila melanogaster</i>	Dominant lethal mutations	No data	+	Vasudev and Krishnamurthy 1979
<i>D. melanogaster</i>	Nondisjunction	No data	–	Ramel and Magnusson 1979
<i>D. melanogaster</i>	Sex-linked recessive lethal mutations	No data	–	Inoue and Watanabe 1978
Mammalian cells:				
Mouse spleen cells	Chromosomal aberration	No data	+	Fahmy and Aly 2000
Chinese hamster ovary Hy cells	Chromosomal aberration	No data	+	Rohr and Bauchinger 1976
Chinese hamster ovary CHO cells	Chromosomal aberration	No data	+	Deaven and Campbell 1980
Chinese hamster ovary CHO cells	Chromosomal aberration	No data	+	Cai and Arenaz 1998
Human leukocytes	Chromosomal aberrations	No data	+	Shiraishi et al. 1972
Human blood lymphocytes	Chromosomal aberration	No data	–	Paton and Allison 1972
Human blood lymphocytes	Chromosomal aberration	No data	+	Shiraishi et al. 1972

3. HEALTH EFFECTS

Table 3-11. Genotoxicity of Cadmium *In Vitro*

Species (test system)	End point	Results		Reference
		With activation	Without activation	
Human blood lymphocytes	Chromosomal aberration	No data	–	Deknuddt and Deminatti 1978
Human blood lymphocytes	Chromosomal aberration	No data	±	Gasiorek and Bauchinger 1981
Human blood lymphocytes	DNA breaks	No data	+	Depault et al. 2006
Human lymphoblastoid cells	DNA breaks	No data	+	Mikhailova et al. 1997
Human fetal hepatic WRL-68 cells	DNA breaks	No data	+	Lopez-Ortal et al. 1999
Chinese hamster ovary CHO-K1 cells	DNA damage	No data	–	Misra et al. 1998
Rat L6 myoblast cells	DNA damage	No data	–	Misra et al. 1998
Rat Clone 9 liver cells	DNA damage	No data	–	Misra et al. 1998
Rat TRI 1215 liver cells	DNA damage	No data	–	Misra et al. 1998
Human blood lymphocytes	DNA damage	No data	+	Rozgaj et al. 2002
Human hepatoma cells (HepG2)	DNA damage	No data	+	Fatur et al. 2002
V79 Chinese hamster lung cells	DNA lesions	No data	+	Jianhua et al. 2006
Chinese hamster ovary CHO-K1 cells	DNA repair	No data	+	Lynn et al. 1997
Human 293T-Tet-Off-hMLH1 cells	DNA repair	No data	+	Lutzen et al. 2004
V79 Chinese hamster lung cells hprt locus	Gene mutation	No data	+	Jianhua et al. 2006
A _L human-hamster hybrid CD59 gene	Gene mutation	No data	+	Filipic and Hei 2004
Mouse lymphoma L5178Y thymidine kinase locus	Gene mutation	No data	±	Amacher and Paillet 1980
Mouse lymphoma L5178Y thymidine kinase locus	Gene mutation	No data	+	Oberly et al. 1982
Mouse lymphoma L5178Y thymidine kinase locus	Gene mutation	+	+	Honma et al. 1999
Human blood lymphocytes	Micronuclei	No data	+	Migliore et al. 1999
Human blood lymphocytes (G ₀ phase)	Micronuclei	No data	–	Kasuba and Rozgaj 2002
Human blood lymphocytes (S phase)	Micronuclei	No data	+	Kasuba and Rozgaj 2002
Human diploid fibroblasts (MRC-5)	Micronuclei	No data	+	Seoane and Dulout 2001
Mouse spleen cells	Sister chromatid exchanges	No data	+	Fahmy and Aly 2000

3. HEALTH EFFECTS

Table 3-11. Genotoxicity of Cadmium *In Vitro*

Species (test system)	End point	Results		Reference
		With activation	Without activation	
Human blood lymphocytes	Sister chromatid exchanges	No data	–	Bassendowska-Karska and Zawadzka-Kos 1987
Human blood lymphocytes (G ₀ phase)	Sister chromatid exchanges	No data	–	Saplakoglu and Iscan 1998
Human blood lymphocytes (S phase)	Sister chromatid exchanges	No data	+	Saplakoglu and Iscan 1998
Syrian hamster embryo cells	Transformation	No data	+	Casto et al. 1979
Rat ventral prostate cells	Transformation	No data	+	Terracio and Nachtigal 1988
Rat hepatocytes	Unscheduled DNA synthesis	No data	+	Denizeau and Marion 1989

– = negative result; + = positive result; ± = weakly positive; CHO = Chinese hamster ovary; DNA = deoxyribonucleic acid; NA = not applicable; RNA = ribonucleic acid

3. HEALTH EFFECTS

human cells have shown mixed results (Deknudt and Deminatti 1978; Gasiorek and Bauchinger 1981; Paton and Allison 1972; Shiraishi et al. 1972). For the most part, *in vitro* studies have not shown cadmium to induce SCE in human cells (Bassendowska-Karska and Zawadzka-Kos 1987; Saplakoglu and Iscan 1998). However, a study by Fahmy and Aly (2000) did observe SCE in mouse spleen cells following cadmium treatment. Kasuba and Rozgaj (2002) and Saplakoglu and Iscan (1998) evaluated the ability of cadmium to induce micronuclei and SCE in human lymphocytes *in vitro* respectively, at two different stages of the cell cycle, G₀ and S phase. These studies observed that the genotoxicity of cadmium may vary depending on the stage of the cell cycle as both micronuclei and SCE were induced in cells in S phase, but not in cells in G₀ phase. These observations may in part explain some of the contradictory findings regarding cadmium genotoxicity in the literature.

Positive mutagenicity results have been found in some studies using bacterial cells (Kanematsu et al. 1980; Mandel and Ryser 1984; Nishioka 1975; Wong 1988), in studies using yeast (Putrament et al. 1977; Schiestl et al. 1989), and in a single study using *Drosophila melanogaster* (Vasudev and Krishnamurthy 1979). Other studies report negative mutagenicity results in bacterial cells (Bruce and Heddle 1979; Milvy and Kay 1978) and in *D. melanogaster* (Inoue and Watanabe 1978; Ramel and Mangusson 1979).

3.4 TOXICOKINETICS

Cadmium metal and cadmium salts are not well absorbed; approximately 25, 1–10, or <1% of the dose is absorbed following inhalation, oral, or dermal exposure. Several factors can influence inhalation and oral absorption efficiency; for example, cadmium in cigarette smoke has a higher absorption efficiency due to its small particle size and cadmium absorption from the gastrointestinal tract is increased in individuals with poor iron status. Following absorption from any route of exposure, cadmium widely distributes throughout the body, with the highest concentrations found in the liver and kidney. Cadmium is not known to undergo any direct metabolic conversion such as oxidation, reduction, or alkylation. Absorbed cadmium is excreted very slowly, with urinary and fecal excretion being approximately equal. Approximately 0.007 and 0.009% of the body burden is excreted in the urine and feces, respectively, per day.

3. HEALTH EFFECTS

3.4.1 Absorption**3.4.1.1 Inhalation Exposure**

Cadmium metal and cadmium salts have low volatility and exist in air primarily as fine suspended particulate matter. When inhaled, some fraction of this particulate matter is deposited in the airways or the lungs, and the rest is exhaled. Large particles (greater than about 10 μm in diameter) tend to be deposited in the upper airway, while small particles (approximately 0.1 μm) tend to penetrate into the alveoli. While some soluble cadmium compounds (cadmium chloride and cadmium sulfate) may undergo limited absorption from particles deposited in the respiratory tree, the major site of absorption is the alveoli. Thus, particle size, which controls alveolar deposition, is a key determinant of cadmium absorption in the lung (Nordberg et al. 1985).

No direct data are available on cadmium deposition, retention, or absorption in the human lung. Data from animal studies indicate that lung retention is greatest after short-term exposure (5–20% after 15 minutes to 2 hours) (Barrett et al. 1947; Henderson et al. 1979; Moore et al. 1973; Rusch et al. 1986). The initial lung burden declines slowly after exposure ceases (Henderson et al. 1979; Moore et al. 1973; Rusch et al. 1986) due to absorption of cadmium and lung clearance of deposited particles. After longer periods of inhalation exposure to cadmium, somewhat lower lung retentions are found (Glaser et al. 1986). The absorption of cadmium in lung differs somewhat among chemical forms, but the pattern does not correlate with solubility (Glaser et al. 1986; Rusch et al. 1986).

Based on comparison of cadmium body burdens in human smokers and nonsmokers, cadmium absorption from cigarettes appears to be higher than absorption of cadmium aerosols measured in animals (Nordberg et al. 1985). The chemical form of cadmium in cigarette smoke is likely to be similar to that produced by other combustion processes, primarily cadmium oxide aerosols. The greater absorption of cadmium from cigarette smoke is likely due to the very small size of particles in cigarette smoke and the consequent very high alveolar deposition (Nordberg et al. 1985; Takenaka et al. 2004).

Based on the physiology of the human respiratory tree, a comprehensive model has been developed to predict the kinetics of inhaled cadmium in humans (Nordberg et al. 1985). Results of this model suggest that only about 5% of particles $>10 \mu\text{m}$ in diameter will be deposited, up to 50% of particles $<0.1 \mu\text{m}$ will be deposited, and between 50 and 100% of cadmium deposited in the alveoli will ultimately be absorbed (Nordberg et al. 1985).

3. HEALTH EFFECTS

3.4.1.2 Oral Exposure

Most ingested cadmium passes through the gastrointestinal tract without being absorbed (Kjellström et al. 1978). Measurement of gastrointestinal absorption is complicated by the fact that not all of a dose initially retained in the gastrointestinal system can be considered to be absorbed, because some portion may be trapped in the intestinal mucosa without crossing into the blood or lymph (Foulkes 1984). Thus, measures of whole-body cadmium retention may overestimate cadmium absorption (at least in the short-term). On the other hand, some absorbed cadmium may be excreted in urine or feces, so that retention may underestimate exposure. However, this underestimate is probably minor because excretion of absorbed cadmium is very slow (see Section 3.4.4.2).

Cadmium absorption has been estimated based on the retention of cadmium in the bodies of humans following ingestion of radioactive cadmium. Estimated cadmium absorption ranged from 1.1 to 10.6% (Flanagan et al. 1978; McLellan et al. 1978; Newton et al. 1984; Rahola et al. 1973; Shaikh and Smith 1980; Vanderpool and Reeves 2001). Although some studies have reported higher absorption levels (25–42%), this was based on cadmium retention measurements for 3–5 days after exposure that was probably too short to accurately measure cadmium transfer from the intestinal mucosa to circulation (Crews et al. 2000; Rahola et al. 1973). Using estimated cadmium intakes from national data and measured renal and urinary cadmium levels in healthy nonsmokers, cadmium absorption rates of 3–5% have been estimated (Ellis et al. 1979; Morgan and Sherlock 1984). In a balance study of women with high background cadmium intakes (mean urinary cadmium levels of 2.7–5.16 µg/g creatinine); the mean absorption rate in subjects examined for 7 days was 6.5% (Horiguchi et al. 2004).

The body store of iron influences cadmium absorption; subjects with low iron stores (assessed by serum ferritin levels) had an average absorption of 6 and 8.9%, while those with adequate iron stores had an average absorption of 2.3 and 2.4% (Flanagan et al. 1978; Shaikh and Smith 1980). Several epidemiology studies have found significant negative correlations between body iron (assessed via serum ferritin and/or transferrin levels) and cadmium body burden (blood cadmium and/or urinary cadmium levels) among men and women (Apinan et al. 2010) and among never-smoking, nonpregnant, nonmenopausal women (Gallagher et al. 2011; Meltzer et al. 2010). Studies in rats have shown that iron deficiency results in the upregulation of divalent metal transporter 1 (DMT1) and metal transporter protein 1 (MTP1) in the duodenum, which may facilitate the absorption of cadmium (Kim et al. 2007; Ryu et al. 2004). Other epidemiology studies have found significantly higher cadmium body burdens in women with lower iron stores (Kippler et al. 2009). In contrast, a study of anemic females with high

3. HEALTH EFFECTS

background cadmium levels did not find a significant alteration in cadmium absorption, as compared to healthy females; however, cadmium absorption was lower in the anemic group (13.6%) than in healthy group (27.4%) (Horiguchi et al. 2004). It is not known if the differences in the methods used to estimate cadmium absorption (kinetic study using radiolabelled cadmium versus a balance study) or the high background cadmium intake in the Horiguchi study resulted in the discrepancy between the two studies. There is some indication that not all forms of cadmium are equally absorbed. Some populations with high dietary-cadmium exposure from Bluff oysters (McKenzie-Parnell et al. 1988) or seal meat (Hansen et al. 1985) have been found not to have elevated blood-cadmium levels, perhaps due to the particular form of cadmium in these foods.

Crews et al. (2000) estimated that 42% of a cadmium dose incorporated into porridge was retained in the body 5 days after exposure (as measured by fecal excretion of radiolabelled cadmium); however, the fecal collection period was probably too short to accurately measure cadmium absorption. The investigators also attempted to measure cadmium absorption in 12-month-old infants; 18% of the labeled cadmium in the porridge was retained in the body after 4 days. As with the adult data, the collection period may have been too short to accurately measure cadmium absorption in the infants.

Most estimates of cadmium absorption in animals are somewhat lower than the values found from human studies, particularly after prolonged exposure. In mice, 0.27–3.2% of an oral dose of cadmium chloride was retained after 3–5 days (Bhattacharyya et al. 1981; Engstrom and Nordberg 1979), and in rats, 2–3% of a single oral dose of cadmium chloride was retained (Moore et al. 1973; Schafer et al. 1990). Following 30 days of oral exposure, 0.2–0.3% of an administered dose was retained in rats (Muller et al. 1986). After 4 weeks of dietary exposure to cadmium, absorption of cadmium was reduced to one-third the absorption of rats without pre-exposure to cadmium (Schafer et al. 1990). Cadmium pigments (cadmium sulfide and cadmium sulfoselenide) appear to be absorbed much less than cadmium chloride in rats (ILZRO 1977). Increases in absorption have been observed during gestation and lactation, 0.37 and 0.35% of cadmium administered via gavage was absorbed in mice on gestation days 8 and 15 and 0.56, 0.60, and 0.30% on lactation days 10, 17, and 24, as compared to 0.27% in nonpregnant controls; absorption was only significantly different from nonpregnant controls on lactation days 10 and 17 (Bhattacharyya et al. 1981). Similar findings were observed in mice continuously exposed to cadmium during pregnancy and/or lactation (Bhattacharyya et al. 1982, 1986).

The absorption of cadmium from the gastrointestinal tract has been extensively studied in rats and mice, and a number of factors are recognized that influence absorption. Absorption appears to take place in two

3. HEALTH EFFECTS

phases: uptake from lumen into mucosa, and transfer into the circulation (Foulkes 1985). Phase 1 may involve sequestering of cadmium by metallothionein (Foulkes 1980), but any protective effect is overloaded at moderate doses (Kotsonis and Klaassen 1978). Uptake behaves like a saturable process with fractional absorption decreasing at high concentrations (Foulkes 1980). There is evidence, however, to suggest that this saturation results from charge neutralization at the membrane (Foulkes 1985), so that it need not be assumed that there is a specific system for carrying cadmium into the body. At doses high enough to damage gastrointestinal mucosa, fractional absorption is increased (Andersen et al. 1988; Goon and Klaassen 1989; Lehman and Klaassen 1986). Cadmium bound to metallothionein was absorbed by rats to a lesser extent than cadmium added to the diet as cadmium chloride, but kidney cadmium content was only slightly less (Groten et al. 1990).

Maitani et al. (1984) compared the distribution of cadmium after oral administration of either cadmium ions or Cd-thionein in male CF-1 mice given 0.5 mg Cd/kg, per os (po), as cadmium chloride in saline, cadmium chloride in control rat liver homogenate, cadmium thionein in saline, Cd-TH in liver homogenate, or liver homogenate from Cd-treated rats. In all cases, 85–90% of the cadmium dose was present in feces within 24 hours. However, in groups receiving cadmium chloride, more cadmium was found in feces on days 2 and 3, compared to those receiving cadmium-thionein. In a companion study, tissue levels indicated that less cadmium was absorbed when rats received cadmium-thionein in saline than cadmium chloride in saline. Cadmium-thionein added to liver homogenate or liver homogenate containing cadmium-thionein increased the absorption of cadmium, resulting in renal cadmium levels similar to those in mice receiving cadmium chloride in saline. The kidney/liver cadmium concentration ratio (9) was the same for cadmium-thionein in all three media. Although Cd-TH gave much higher kidney/liver cadmium ratios than cadmium chloride (9 versus 2), renal cadmium concentrations were the same or lower than after cadmium chloride treatments. The authors concluded that the high kidney/liver cadmium ratio after cadmium-thionein treatment versus cadmium chloride was due to lower concentrations of cadmium in liver rather than marked increases in renal cadmium levels. While the chemical form of cadmium administered affects the absorption and distribution, the amount of cadmium reaching the kidney after cadmium-thionein administration is similar to that after cadmium chloride administration.

At moderate doses of cadmium, the presence of divalent and trivalent cations, such as calcium, chromium, magnesium, and zinc, may decrease cadmium uptake, probably by a nonspecific effect on the charge distribution of the intestinal brush border membrane (Foulkes 1985). However, the influence of cations on cadmium absorption is complex, because zinc can increase the amount of cadmium absorbed

3. HEALTH EFFECTS

from the intestine (Jaeger 1990). A refined diet high in fat and protein increases cadmium absorption in mice, partially due to increased gastrointestinal passage time (Schafer et al. 1986). Studies in newborn rats and pigs also provide evidence that diet constituents influence cadmium absorption; absorption of cadmium chloride was higher when administered in water compared to cereal-based infant formula (Eklund et al. 2001, 2004). Diets low in iron increase cadmium absorption (Flanagan et al. 1978; Reeves and Chaney 2001, 2002; Schafer et al. 1990); a diet low in calcium will also increase cadmium absorption (Reeves and Chaney 2001, 2002). In contrast, low levels of dietary iron did not increase cadmium absorption in suckling piglets; however, iron supplementation did increase cadmium absorption (Öhrvik et al. 2007); this difference may be due to the high cadmium dose used in the study. Zinc deficiency may result in an increased accumulation of cadmium in the intestinal wall, but does not affect transport into the blood (Foulkes and Voner 1981; Hoadley and Cousins 1985). The absorption of cadmium in rats depends on age, with measured absorption decreasing from 12 to 5 to 0.5% at 2 hours, 24 hours, and 6 weeks after birth, respectively (Sasser and Jarboe 1977). Sasser and Jarboe (1980) also reported that absorption of cadmium in the gastrointestinal tract of young guinea pigs was 20-fold higher than in adult guinea pigs. Thus, for a given individual, the absorption following oral exposure to cadmium is likely to depend on physiologic status (age; body stores of iron, calcium, and zinc; pregnancy history; etc.) and, also, on the presence and levels of ions and other dietary components ingested with the cadmium.

3.4.1.3 Dermal Exposure

A few measurements of dermal absorption of cadmium in animals have been made, with only one *in vitro* study using human skin to determine the percutaneous absorption of cadmium.

A study by Wester et al. (1992) evaluated the percutaneous absorption of cadmium from water and soil into and through human skin using *in vitro* skin cells. Radioactive cadmium (^{109}Cd cadmium chloride) was made to a concentration of 116 ppb in water or 13 ppb in filtered soil (26% sand, 26% clay, 48% silt, 0.9% organic content). Cadmium chloride was administered either at 5 $\mu\text{L}/\text{cm}^2$ or 2 volumes of 2.5 $\mu\text{L}/\text{cm}^2$ (the same amount of cadmium apparently applied). Human cadaver skin dermatomed at 500 μm was placed in flow-through skin cells and perfused with human plasma. Approximately 0.1–0.6% of the cadmium chloride in water entered the plasma perfusate over the 16-hour perfusion period, while 2.4–12.7% of applied dose remained in the skin. Most of the cadmium (74–93%) remained unabsorbed and was recovered from the skin surface. Total recoveries ranged from 88 ± 20 to 103 ± 3 . When cadmium-contaminated soil (13 ppb cadmium chloride) was applied to the skin surface, plasma levels ranged from 0.02 to 0.07% of the applied dose, while the skin contained 0.06–0.13% of applied

3. HEALTH EFFECTS

dose. Surface wash ranged from 82 to 102% of applied dose. Total recoveries were from 83 ± 33 to 106 ± 2 . The large differences between water and soil absorption into the plasma and retention in the skin were attributed to differences in cadmium partition coefficients, measured to be 3.61×10^1 for stratum corneum (powdered):water and 1.03×10^5 for soil:water. These measurements indicate that soil has a relatively higher affinity for cadmium than does the stratum corneum. The transfer of cadmium from soil to skin depends on the soil's binding capacity and water retention and variables describing the physical contact with the skin. When cadmium levels in the soil were increased from 6.5 to 65 ppb, skin levels correspondingly increased, but plasma receptor fluid levels remained constant. This suggests that, with *in vitro* perfusion, the surface concentration of cadmium will influence skin cadmium concentration, but that absorption into plasma receptor fluid is relatively independent of the skin surface concentration. The authors offer the caveat that *in vitro* methods can influence results and therefore, the receptor fluid accumulation must be interpreted with caution. The authors calculate that a whole-body exposure to cadmium at 116 ppb in water with 0.5% absorption will result in a daily systemic intake of about 10 μg cadmium.

A few animal studies are available that describe the percutaneous absorption of cadmium as estimated from the accumulation of cadmium in the liver and kidneys of mice and rabbits. Male rabbits (strain not specified) dosed with cadmium chloride percutaneously via a 1% aqueous solution (6.1 mg cadmium) or 2% ointment (12.2 mg cadmium) over a 10-cm² shaved area (Kimura and Otaki 1972). Animals were treated 5 times over 3 weeks (duration of exposure not reported) and were killed 2 weeks after the last application. Only cadmium contents of liver and kidney were measured, so total absorption through the skin may have been greater. Accumulated amounts of cadmium in the liver and kidneys were found to be 0.4–0.61% 2 weeks after the end of cadmium exposure. This percentage was similar for aqueous solution or hydrocarbon ointment. Similarly, male hairless mice (strain not specified) were dosed with cadmium chloride percutaneously with a 2% ointment (containing 0.61 mg cadmium) 1 or 5 times in a week (duration of exposure not reported) and killed 1 week later (Kimura and Otaki 1972). Accumulated amounts of cadmium in the liver and kidneys were found to be 0.2–0.87%.

Cadmium was detected in liver, kidneys, and urine following dermal exposure in guinea pigs (Skog and Wahlberg 1964). The disappearance of cadmium from cadmium chloride in water applied to guinea pig skin was dependent on concentration, with a peak mean absorption of 1.8% over 5 hours at 0.239 molar cadmium (about a 2.7% solution). Less absorption occurred both at higher and lower concentrations of a cadmium chloride solution applied to the skin (Skog and Wahlberg 1964).

3. HEALTH EFFECTS

The results from all of these studies suggest that dermal absorption is slow, and would be of concern only in situations where concentrated solutions would be in contact with the skin for several hours or longer.

3.4.2 Distribution

Cadmium is widely distributed in the body, with the major portion of the body burden located in the liver and kidney. Animals and humans appear to have a similar pattern of distribution that is relatively independent of route of exposure, but somewhat dependent on duration of exposure.

3.4.2.1 Inhalation Exposure

Cadmium was found in autopsy samples from nearly all organs of a worker extensively exposed to cadmium dust, with greatest concentrations in the liver, kidney, pancreas, and vertebrae (Friberg 1950). In workers dying from inhalation of cadmium, lung-cadmium concentration was somewhat lower than liver or kidney cadmium concentration (Beton et al. 1966; Lucas et al. 1980; Patwardhan and Finckh 1976). The concentration of cadmium in the liver of occupationally exposed workers generally increases in proportion to intensity and duration of exposure to values up to 100 $\mu\text{g/g}$ (Gompertz et al. 1983; Roels et al. 1981b). The concentration of cadmium in the kidney rises more slowly than in the liver after exposure (Gompertz et al. 1983) and begins to decline after the onset of renal damage at a critical concentration of 160–285 $\mu\text{g/g}$ (Roels et al. 1981b).

In animals acutely exposed to cadmium carbonate aerosols, about 60% of the inhaled dose is found in the gastrointestinal tract, transported by mucociliary clearance (Moore et al. 1973). Following a 2-hour inhalation of approximately 100 mg/m^3 of cadmium, cadmium concentration in rat liver increased from an initial concentration of 0.8 $\mu\text{g/g}$ in males and 1.9 $\mu\text{g/g}$ in females immediately after exposure up to a peak of about 2 $\mu\text{g/g}$ in males and 3.8 $\mu\text{g/g}$ in females 1 week postexposure, then declined to 1.7 and 2.5 $\mu\text{g/g}$, respectively, by 30 days postexposure. The kidney concentrations were initially <0.5 $\mu\text{g/g}$ in males and females, rising to approximately 8 $\mu\text{g/g}$ in both sexes by 1 week postexposure and to 18 $\mu\text{g/g}$ in males and 15 $\mu\text{g/g}$ in females by 30 days postexposure (Rusch et al. 1986).

3.4.2.2 Oral Exposure

As discussed in Chapter 6, most nonoccupationally exposed people are exposed to cadmium primarily through the diet. Cadmium can be detected in virtually all tissues in adults from industrialized countries, with greatest concentrations in the liver and kidney (Chung et al. 1986; Sumino et al. 1975). Average

3. HEALTH EFFECTS

cadmium concentrations in the kidney are near zero at birth, and rise roughly linearly with age to a peak (typically around 40–50 $\mu\text{g/g}$ wet weight) between ages 50 and 60, after which kidney concentrations plateau or decline (Chung et al. 1986; Hammer et al. 1973; Lauwerys et al. 1984). Liver cadmium concentrations also begin near zero at birth, increase to typical values of 1–2 $\mu\text{g/g}$ wet weight by age 20–25, then increase only slightly thereafter (Chung et al. 1986; Hammer et al. 1973; Lauwerys et al. 1984; Sumino et al. 1975).

Distribution of cadmium in animals after oral exposure is similar to that found in humans, with highest accumulation in the liver and kidneys, and lower levels spread throughout the rest of the body (Kotsonis and Klaassen 1978; Weigel et al. 1984). Liver and kidney cadmium concentrations are comparable after short-term exposure (Andersen et al. 1988; Jonah and Bhattacharyya 1989), but the kidney concentration exceeds the liver concentration following prolonged exposure (Kotsonis and Klaassen 1978), except at very high exposures (Ando et al. 1998; Bernard et al. 1980; Hiratsuka et al. 1999). In mice orally exposed to cadmium during lactation, 53% of the whole-body cadmium was found in the kidneys as compared to 27% in nonpregnant controls (Bhattacharyya et al. 1982).

Maitani et al. (1984) compared the distribution of cadmium in rats after an acute oral administration of either cadmium ions or cadmium bound to metallothionein. In all cases, 85–90% of the dose was present in the feces within 24 hours postexposure. More of the cadmium-thionein was retained after 2–3 days, and less of the cadmium-thionein was distributed to the liver than was the case for the ionic cadmium. Kidney levels were comparable.

The placenta may act as a partial barrier to fetal exposure to cadmium. Cadmium concentration has been found to be approximately half as high in cord blood as in maternal blood in several studies including both smoking and nonsmoking women (Kuhnert et al. 1982; Lauwerys et al. 1978; Truska et al. 1989). Accumulation of cadmium in the placenta at levels about 10 times higher than maternal blood cadmium concentration has been found in studies of women in Belgium (Roels et al. 1978) and the United States (Kuhnert et al. 1982); however, in a study in Czechoslovakia, the concentration of cadmium in the placenta was found to be less than in either maternal or cord blood (Truska et al. 1989). In mice orally exposed to cadmium during pregnancy, maternal blood, placental, and fetal cadmium concentrations were essentially equal among control animals (with environmental cadmium exposure), but placental concentration increased with cadmium dose much more rapidly than either maternal blood or fetal cadmium concentration (Sorell and Graziano 1990). Thus, timing and level of cadmium exposure may influence the uptake of cadmium by the placenta, perhaps explaining the conflicting human studies.

3. HEALTH EFFECTS

Goyer and Cherian (1992) localized metallothionein in full-term human placenta and in fetal cells in human placenta. Metallothionein was present in trophoblasts (which facilitate transport of substances entering the placenta from the maternal blood), Hofbauer cells (motile macrophages capable of phagocytosis and protein ingestion), amniotic epithelial cells (fetal derivatives), and decidual cells (endometrial stromal cells that have been transformed under hormonal influence into large pale cells, rich in glycogen). The mechanism by which the placenta transports the essential metals, copper and zinc, while limiting the transport of cadmium is unknown, but may involve the approximately 1,000-fold higher concentration of zinc in the placenta and the higher affinity of cadmium than zinc for metallothionein.

Cadmium levels in human milk are 5–10% of levels in blood, possibly due to inhibited transfer from blood because of metallothionein binding of cadmium in blood cells (Radisch et al. 1987). Bhattacharyya et al. (1982) examined the maternal transfer of cadmium to pups during gestation and lactation in mice. Approximately 3, 11, and 25% of maternal cadmium was transferred to the pups following gestation-only exposure, lactation-only exposure, and gestation and lactation exposure, respectively.

3.4.2.3 Dermal Exposure

No studies were located regarding distribution in humans after dermal exposure to cadmium. Elevated levels of cadmium were found in the liver and kidneys of rabbits and mice dermally exposed to cadmium (Kimura and Otaki 1972).

3.4.3 Metabolism

Cadmium is not known to undergo any direct metabolic conversion such as oxidation, reduction, or alkylation. The cadmium (+2) ion does bind to anionic groups (especially sulfhydryl groups) in proteins (especially albumin and metallothionein) and other molecules (Nordberg et al. 1985). Plasma cadmium circulates primarily bound to metallothionein, and albumin (Foulkes and Blanck 1990; Roberts and Clark 1988).

3.4.4 Elimination and Excretion

Most cadmium that is ingested or inhaled and transported to the gut via mucociliary clearance is not absorbed and is excreted in the feces. Absorbed cadmium is excreted very slowly, with urinary and fecal

3. HEALTH EFFECTS

excretion being approximately equal (Kjellström and Nordberg 1978). The half-time for cadmium in the whole body in humans was >26 years (Shaikh and Smith 1980) and half-times of several months up to several years have been calculated in mice, rats, rabbits, and monkeys (Kjellström and Nordberg 1985). Half-times in the slowest phase were from 20 to 50% of the maximum life span of the animal (Kjellström and Nordberg 1985). In the human body, the main portion of the cadmium body burden is found in the liver and kidney and in other tissues (particularly muscle, skin, and bone). After reviewing the literature, Kjellström and Nordberg (1985) developed a range of half-times from their kinetic model of 6–38 years for the human kidney and 4–19 years for the human liver.

3.4.4.1 Inhalation Exposure

Cadmium excretion in urine of occupationally exposed workers increases proportionally with body burden of cadmium, but the amount of cadmium excreted represents only a small fraction of the total body burden unless renal damage is present; in this case, urinary cadmium excretion markedly increases (Roels et al. 1981b). Fecal excretion in workers occupationally exposed to cadmium reflects mainly cadmium dust swallowed from industrial air and/or incidentally ingested from contaminated hands (Adamsson et al. 1979).

In rats, following a 2-hour inhalation exposure to cadmium carbonate, cadmium was primarily eliminated in the feces, with a minor component (approximately 1% of fecal excretion) in the urine (Rusch et al. 1986). Cadmium excretion by both routes declined with time after exposure, with significantly elevated excretion found at 7 days, but not 30 days, after exposure (Rusch et al. 1986). Most of the cadmium initially excreted in the feces was probably not absorbed, but rather represented particles transported from the lung to the gastrointestinal tract (Moore et al. 1973).

3.4.4.2 Oral Exposure

Following oral exposure, the major proportion of administered cadmium is found in the feces, because absorption is so low (see Section 3.4.1.2) (Kjellström et al. 1978). Among five healthy adult volunteers, fecal excretion of a single dose of radiolabeled cadmium declined with time up to 45 days after ingestion, while urinary excretion remained at a low, near-constant level (Rahola et al. 1973). After about 20 days, fecal and urinary excretion appeared to be comparable (Rahola et al. 1973). In contrast, among four healthy adults ingesting cadmium in intrinsically labeled crabmeat, fecal excretion was 30 times higher than urinary excretion up to 10 weeks after ingestion of the test meal (Newton et al. 1984). In rats orally exposed to up to 0.35 mg/kg/day of cadmium in the diet for 60 days, no significant increase in

3. HEALTH EFFECTS

urinary cadmium content was found (Weigel et al. 1984). The overall excretion of absorbed cadmium is slow, with biological half-times of 70–270 days in rats or mice orally exposed to cadmium (Engstrom and Nordberg 1979; Moore et al. 1973).

In a comprehensive model developed for human cadmium toxicokinetics, parameters for urinary and fecal excretion were derived by adjustments to empirical data derived from human and animal studies (Kjellström and Nordberg 1978, 1985). Fecal excretion constitutes unabsorbed cadmium plus "true" excretion originating from blood via the intestinal wall (a function of cadmium body burden) and from bile via the liver (a function of cadmium liver burden) (Kjellström and Nordberg 1985). Urinary excretion depends on blood concentration and kidney concentration, and total excretion is assumed to equal daily intake at steady state. Using these methods and assumptions, daily fecal and urinary excretion is estimated to be 0.007 and 0.009% of body burden, respectively (Kjellström and Nordberg 1978, 1985). A whole-body retention half-time estimate of >26 years was obtained by Shaikh and Smith (1980) in a study using orally ingested radiolabelled cadmium and monitoring a subject for over 2 years.

Groups of 10 female outbred albino rats were exposed to cadmium in drinking water (as cadmium chloride) at 0 or 4.8 mg/kg/day for 10 weeks (at 4 weeks prior to mating, at 3 weeks of gestation, or 3 weeks into lactation). After weaning, exposure to cadmium was terminated. In dams, kidney concentrations exceeded liver concentrations, while in pups, the renal and liver concentrations were similar at all times during exposure. In pups, both hepatic and renal cadmium concentrations considerably increased only during the second half of the lactation period (Ld 11–21). The concentrations in the dams were several orders higher than in the offspring. After discontinuation of exposure, organ concentration slightly decreased in dams (2% in liver and 12% in kidneys), while in pups, the decrease was 84% in the liver and 62% in the kidneys. These values do not indicate cadmium elimination but rather dilution caused by growth (Kostial et al. 1993).

3.4.4.3 Dermal Exposure

No studies were located regarding excretion in humans after dermal exposure to cadmium. Cadmium was reportedly detected in urine in guinea pigs dermally exposed to aqueous cadmium chloride, but no details are available (Skog and Wahlberg 1964).

3. HEALTH EFFECTS

3.4.5 Physiologically Based Pharmacokinetic (PBPK)/Pharmacodynamic (PD) Models

Physiologically based pharmacokinetic (PBPK) models use mathematical descriptions of the uptake and disposition of chemical substances to quantitatively describe the relationships among critical biological processes (Krishnan et al. 1994). PBPK models are also called biologically based tissue dosimetry models. PBPK models are increasingly used in risk assessments, primarily to predict the concentration of potentially toxic moieties of a chemical that will be delivered to any given target tissue following various combinations of route, dose level, and test species (Clewell and Andersen 1985). Physiologically based pharmacodynamic (PBPD) models use mathematical descriptions of the dose-response function to quantitatively describe the relationship between target tissue dose and toxic end points.

PBPK/PD models refine our understanding of complex quantitative dose behaviors by helping to delineate and characterize the relationships between: (1) the external/exposure concentration and target tissue dose of the toxic moiety, and (2) the target tissue dose and observed responses (Andersen and Krishnan 1994; Andersen et al. 1987a). These models are biologically and mechanistically based and can be used to extrapolate the pharmacokinetic behavior of chemical substances from high to low dose, from route to route, between species, and between subpopulations within a species. The biological basis of PBPK models results in more meaningful extrapolations than those generated with the more conventional use of uncertainty factors.

The PBPK model for a chemical substance is developed in four interconnected steps: (1) model representation, (2) model parameterization, (3) model simulation, and (4) model validation (Krishnan and Andersen 1994). In the early 1990s, validated PBPK models were developed for a number of toxicologically important chemical substances, both volatile and nonvolatile (Krishnan and Andersen 1994; Leung 1993). PBPK models for a particular substance require estimates of the chemical substance-specific physicochemical parameters, and species-specific physiological and biological parameters. The numerical estimates of these model parameters are incorporated within a set of differential and algebraic equations that describe the pharmacokinetic processes. Solving these differential and algebraic equations provides the predictions of tissue dose. Computers then provide process simulations based on these solutions.

The structure and mathematical expressions used in PBPK models significantly simplify the true complexities of biological systems. If the uptake and disposition of the chemical substance(s) are adequately described, however, this simplification is desirable because data are often unavailable for

3. HEALTH EFFECTS

many biological processes. A simplified scheme reduces the magnitude of cumulative uncertainty. The adequacy of the model is, therefore, of great importance, and model validation is essential to the use of PBPK models in risk assessment.

PBPK models improve the pharmacokinetic extrapolations used in risk assessments that identify the maximal (i.e., the safe) levels for human exposure to chemical substances (Andersen and Krishnan 1994). PBPK models provide a scientifically sound means to predict the target tissue dose of chemicals in humans who are exposed to environmental levels (for example, levels that might occur at hazardous waste sites) based on the results of studies where doses were higher or were administered in different species.

Figure 3-3 shows a conceptualized representation of a PBPK model.

If PBPK models for cadmium exist, the overall results and individual models are discussed in this section in terms of their use in risk assessment, tissue dosimetry, and dose, route, and species extrapolations.

3.4.5.1 Summary of Cadmium PBPK Models

Several models have been reported to describe the kinetics of cadmium in mammalian systems. Of these models, the Nordberg-Kjellström model (Kjellström and Nordberg 1978; Nordberg and Kjellström 1979) has been the most widely used for cadmium risk assessment. Three of the most relevant cadmium models will be discussed here.

3.4.5.2 Cadmium PBPK Model Comparison

Although the Nordberg-Kjellström model (Kjellström and Nordberg 1978; Nordberg and Kjellström 1979) has its limitations, it provides the best overall description of cadmium toxicokinetics and is largely based on human data. The Shank (Shank et al. 1977) and Matsubara-Khan (Matsubara-Khan 1974) models are not as useful for human risk assessment applications, but they do provide useful insights into the absorption, distribution, and compartmentalization of cadmium in laboratory animals. These insights may have some future use in human risk assessment as PBPK models for cadmium continue to be refined.

3. HEALTH EFFECTS

Figure 3-3. Conceptual Representation of a Physiologically Based Pharmacokinetic (PBPK) Model for a Hypothetical Chemical Substance

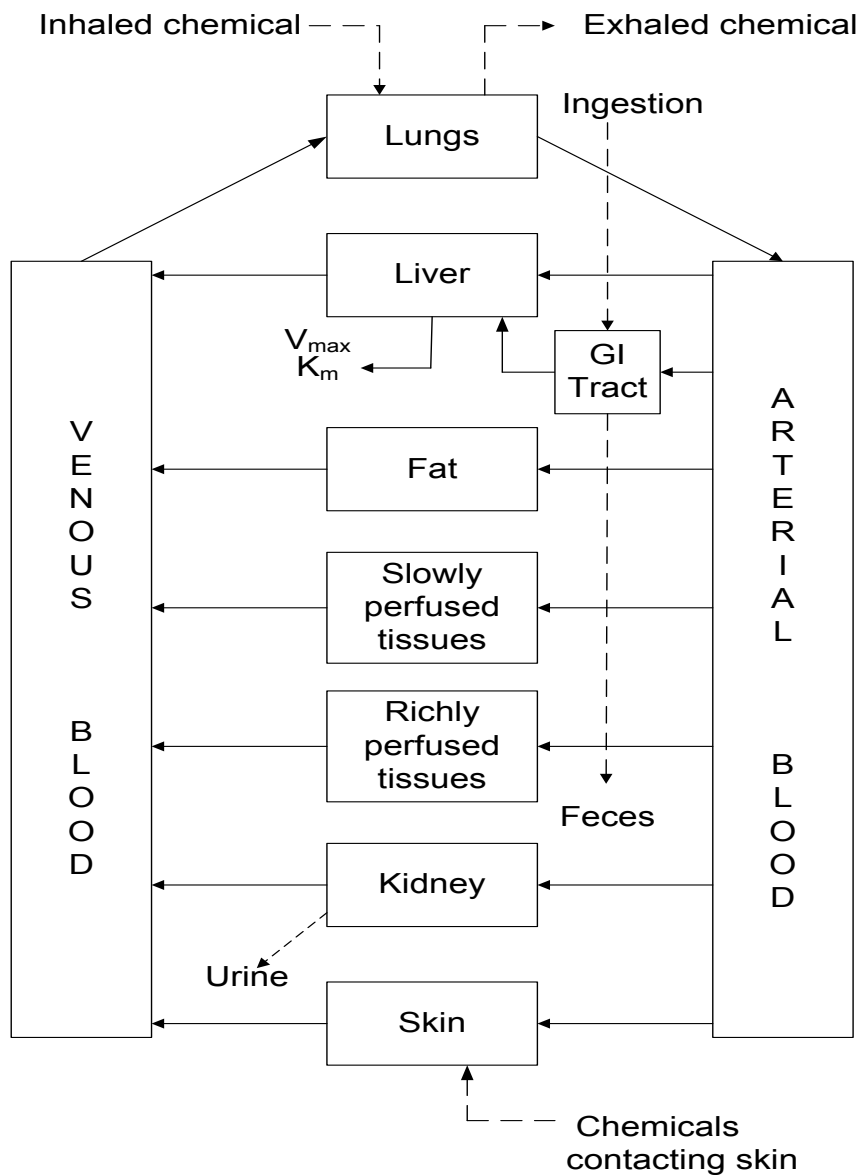

Note: This is a conceptual representation of a physiologically based pharmacokinetic (PBPK) model for a hypothetical chemical substance. The chemical substance is shown to be absorbed via the skin, by inhalation, or by ingestion, metabolized in the liver, and excreted in the urine or by exhalation.

Source: adapted from Krishnan and Andersen 1994

3.4.5.3 Discussion of Cadmium Models

The Nordberg-Kjellström Model

The Nordberg-Kjellström model (Kjellström and Nordberg 1978; Nordberg and Kjellström 1979) is a linear multicompartment model that is the most commonly used model for cadmium risk assessment work today. The Nordberg-Kjellström schematic model diagram is shown in [Figure 3-4](#).

Risk assessment. The Nordberg-Kjellström model has been demonstrated to be a useful model in human risk assessment work. Frazier (1994), however, noted that the model has two major limitations: (1) the linear nature of the model may not adequately allow a good description of known nonlinearities in biological responses to cadmium dosing, and (2) the phenomenological approach taken with this model does not provide a foundation for incorporating biological variability into the model parameters.

Description of the Model. The Nordberg-Kjellström model (see [Figure 3-4](#)) is a linear multicompartment model that describes the disposition of cadmium via the oral and inhalation routes of exposure only. Dermal exposure and subsequent absorption through the skin were assumed to be negligible in this model. For inhalation exposures, the model accounts for different deposition patterns for different size particles in nasopharyngeal, tracheobronchial, and alveolar regions of the respiratory tract. Particles with mass median aerodynamic diameter (MMAD) of 5 μm (i.e., cadmium-laden dust) were assumed to distribute mainly to the nasopharyngeal region (75%), with lesser amounts depositing in the alveolar (20%) and tracheobronchial (5%) regions. Particles of 0.05 μm MMAD (i.e., cigarette smoke) were assumed to deposit 50% in the alveolar compartment, 10% in the tracheobronchial compartment, and none in the nasopharyngeal compartment. The remaining amounts are exhaled. For all particle sizes initially deposited in the nasopharyngeal and tracheobronchial compartments, mucociliary clearance clears some particles from the respiratory tract to enter the oral compartment for absorption or out of the body and back to the environment. Assumed model coefficient values and the available physiological parameters are shown in [Table 3-12](#).

For the oral route of exposure, cadmium may enter the gastrointestinal tract via food or water contaminated with cadmium, or as cadmium particles embedded in mucus from the respiratory tract via the mucociliary/tracheobronchial escalator. By either route of exposure, the model assumes that cadmium enters into any of three blood compartments (B) (see [Figure 3-4](#)). B1 is the plasma compartment where

3. HEALTH EFFECTS

Figure 3-4. A Schematic Representation of the Nordberg-Kjellström Model

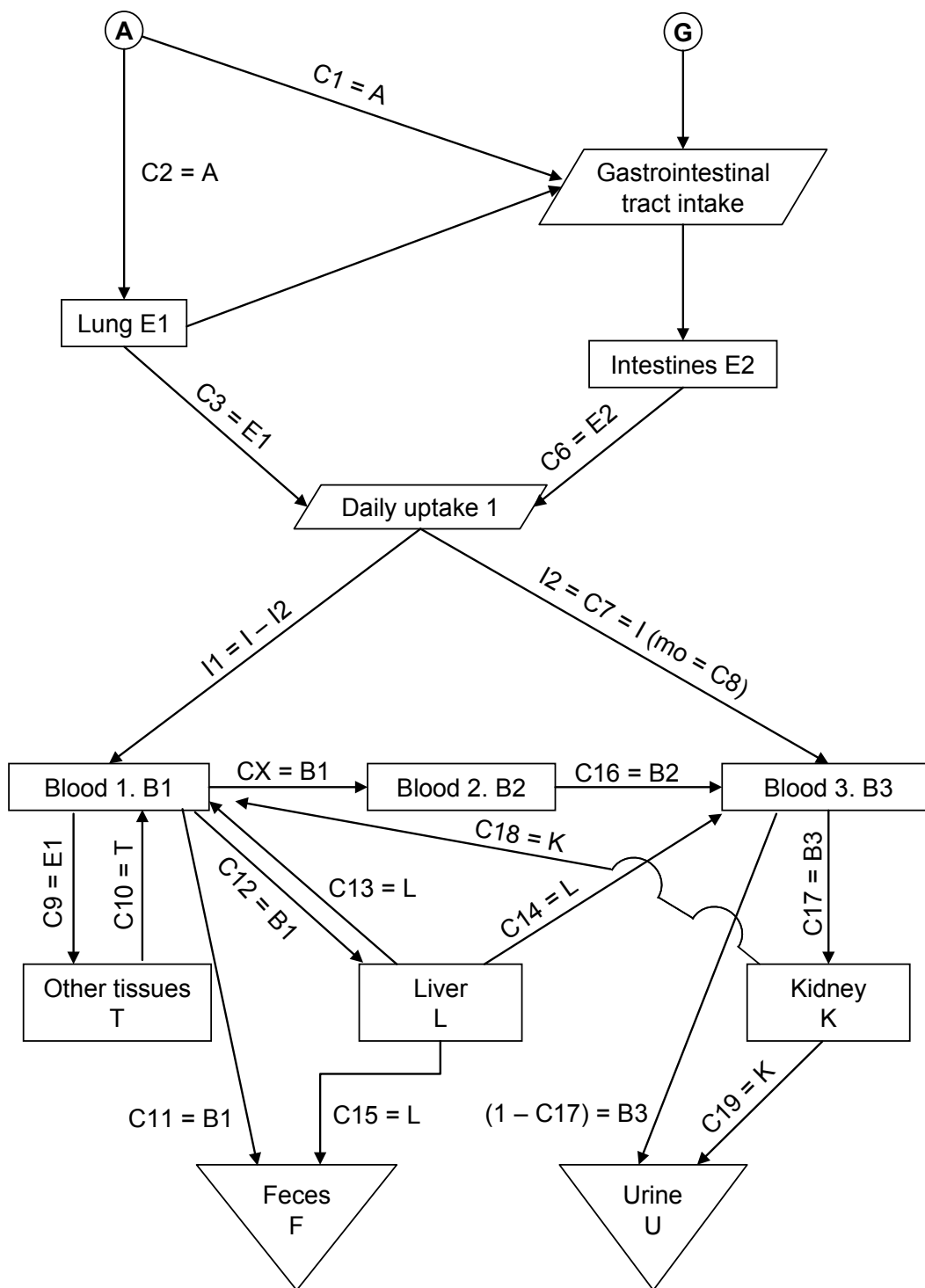

Source: Kjellström and Nordberg 1978

3. HEALTH EFFECTS

Table 3-12. Assumed Model Parameters and Some Physiologic Parameters for the Nordberg-Kjellström Model

Coefficient or parameter	Assumed range	Unit ^a	Values fitting to empirical data
Model parameters			
C1	0.1–0.2 (cigarette smoke)		0.1
	0.4–0.9 (factory smoke)		0.7
C2	0.4–0.6 (cigarette smoke)		0.4
	0.1–0.3 (factory smoke)		0.13
C3	0.01–1.0	day ⁻¹	0.05
C4	0.1xC3 = 0.001–0.1	day ⁻¹	0.005
C5	0.03–0.1		0.048
C6	0.05	day ⁻¹	0.05
C7	0.2–0.4		0.25
C8	0.5–5.0	µg	1
C9	0.4–0.8		0.44
C10	0.00004–0.0002	day ⁻¹	0.00014
C11	0.05–0.5		0.27
C12	0.1–0.4		0.25
C13	0–0.0001	day ⁻¹	0.00003
C14	0.0001–0.0003	day ⁻¹	0.00016
C15	0–0.0001	day ⁻¹	0.00005
C16	0.004–0.015	day ⁻¹	0.012
C17	0.8–0.98		0.95
C18	0–0.0001	day ⁻¹	0.00001
C19	0.00002–0.0002	day ⁻¹	0.00014
CX	0.01–0.05		0.04
C20	0.05–0.5		0.1
C21	0–0.000002	day ⁻¹	0.0000011
Physiologic parameters			
Average liver weight	1,500	gram	
Average blood volume	70	mL/kg	
Average blood specific gravity	1.06		
Average daily urine excretion (adult)	1.0	L	
Average daily urine excretion (aged)	0.9	L	
Average daily urine excretion (child)	0.5	L	

^aBlanks indicate a unitless value.

Source: Kjellström and Nordberg 1978; Nordberg and Kjellström 1979

3. HEALTH EFFECTS

cadmium may bind to plasma components (i.e., albumin and other organic constituents). B2 is the red-blood cell compartment, which represents the accumulation of cadmium in erythrocytes, while B3 represents the binding of cadmium to metallothionein. The model does not take into account induction of metallothionein after cadmium exposure. From the blood, cadmium is calculated to distribute to either the liver, kidney, or "other tissues," the major accumulation sites. Elimination is either via the feces or in the urine. The transport of cadmium between the compartments is assumed to follow first-order exponential functions and is driven on concentration-dependent gradients.

Validation of the model. The Nordberg-Kjellström model was validated using several independent sets of human data from both Sweden and Japan. The data set by Friberg et al. (1974) estimated that smoking 20 cigarettes a day would result in an inhalation of 2–4 $\mu\text{g}/\text{day}$ of cadmium, assuming smoking started at 20 years of age and daily cadmium intake from food was 16 $\mu\text{g}/\text{day}$. Based on the Friberg et al. (1974) data, the model predictions of cadmium concentrations in the kidney agreed well with the observed data from a study by Elinder et al. (1978); however, the model predicted higher than expected values for liver cadmium compared to the observed data from the Elinder study. The model's urinary excretion of cadmium (0.84 $\mu\text{g}/24$ hours for a 50-year-old person) agreed well with the observed data (0.56–0.8 $\mu\text{g}/24$ hours). The model predicted blood cadmium levels for Swedish smokers to be about 2 ng/g which compared well to the actual concentration of 1.6 ng/g.

The model was also validated against a data set for an average 45-year-old Japanese person living in Tokyo whose daily intake of cadmium is 40 μg via food and 2.7 μg via the inhalation route. Subjects were assumed to be smokers averaging 24 cigarettes a day starting at age 20. Based on these exposure conditions, the measured values for cadmium in the kidney, liver, and "other tissues" (in this case, muscle only) were reported to be 65, 3.4, and 0.2 $\mu\text{g}/\text{g}$, respectively, with the model predicting 48, 3.2, and 0.18 $\mu\text{g}/\text{g}$. For blood and urine, the measured values were 4.5 $\mu\text{g}/\text{g}$ for blood and 1.1 $\mu\text{g}/\text{L}$ for urine; the model predicted 3.4 $\mu\text{g}/\text{g}$ and 1.3 $\mu\text{g}/24$ hours (assuming 1 L of urine output/day, the value would be 1.3 $\mu\text{g}/\text{L}$).

Another study of Japanese people reported cadmium concentrations in urine in relation to high cadmium concentrations in rice in their daily diet. For people who consumed rice containing 0.04 $\mu\text{g}/\text{g}$ of rice (240 $\mu\text{g}/\text{day}$), the observed urinary level of cadmium was 7 $\mu\text{g}/\text{L}$; consumption of rice containing 1.1 μg cadmium/g of rice (660 $\mu\text{g}/\text{day}$), resulted in an observed value of 14 $\mu\text{g}/\text{L}$ of urine. After making certain assumptions about the average daily consumption of rice containing an assumed amount of cadmium, and

3. HEALTH EFFECTS

assuming an average urine production of 1 L/day, the model calculated urinary levels of 4.8 and 15.5 µg/L of urine, agreeing well with the observed values.

The model was also validated against a data set with high concentrations of cadmium in air (50 µg/m³) (Piscator 1972) and blood cadmium concentrations ranging from 10 to 50 ng/g whole blood. Calculated blood, urine, liver, and kidney levels of cadmium agreed only roughly with the observed values; however, the authors concluded that the model predictions may not be accurate based on the observations that workers with long exposure histories had most likely experienced higher exposure levels in the past, skewing the data set, resulting in poor model predictions. Another data set by Piscator (1984) involved a group of Swedish workers involved in polishing cadmium-plated objects, who were exposed to high concentrations of cadmium for ≤2 years. Cadmium levels were measured in the urine and blood. When this exposure data set was input into the model, the model could not adequately predict blood and urine levels for these workers.

Target tissues. The Nordberg-Kjellström model assumes that the kidney and liver are the two specific target tissues in which cadmium accumulates. The model also accounts for all other tissue accumulation in the "other tissues" compartment (i.e., muscle). The model assumes a human liver tissue half-life ($t_{1/2}$) of 4–19 years and a kidney $t_{1/2}$ of 6–38 years. For the "other tissue" compartments, $t_{1/2}$ was assumed to be 9–47 years. The Nordberg-Kjellström model does account for the loss of renal tubular epithelial cells leading to a loss of tubular reabsorptive capacity. This loss of cells could conceivably result in an increase in the excretion of cadmium from the tubules and an increase in the transport of cadmium from the tubules to the blood. This loss of cells is theorized to account for the large $t_{1/2}$ range for cadmium in the kidney. The model assumed that no changes in the movement of cadmium from the kidney to blood occurred with age and that the loss of cadmium from the kidney to the urine increased linearly after the age of 30.

The Nordberg-Kjellström model also accounted for differences in kidney and liver weights among different age groups and between peoples of different ethnic origins. The model corrected for differences in liver, kidney, blood, and "other tissue" weights with relation to age (1 and 79 years of age) and ethnicity (Japan and Sweden).

Species extrapolation. The Nordberg-Kjellström model was based solely on data collected from humans and was intended for human risk assessment applications. The model did not address any potential application for this model of cadmium in laboratory animals.

3. HEALTH EFFECTS

High-low dose extrapolation. The Nordberg-Kjellström model has been shown to adequately predict fluid and tissue concentrations via the oral and inhalation routes of exposure for humans exposed to low doses of cadmium. However, the model has difficulty in adequately predicting fluid and tissue concentrations in humans exposed to high concentrations of cadmium, especially for those individuals exposed to high concentrations via the inhalation route.

Interroute extrapolation. The Nordberg-Kjellström model adequately predicted the fate of cadmium in target tissues after exposure via the inhalation and oral routes. The dermal route of exposure was not incorporated into the model parameters and was considered an insignificant route of exposure in humans.

The Shank Model

Risk assessment. The Shank model (Shank et al. 1977) may have the potential to serve as an alternative mathematical model for predicting the retention of cadmium in biological systems. Unfortunately, no human data were used to validate the Shank model for use as a risk assessment tool in cases of human exposure. In addition, the Shank model was validated only for the intravenous and subcutaneous routes of exposure; no data were presented for the oral, inhalation, or dermal routes of exposure.

Description of the model. A schematic representation of the Shank model is illustrated in [Figure 3-5](#). The model mathematically represents the dynamic transport of cadmium between compartments in a mammalian biological system based on the male adult SW/NIH mouse as the test animal species. The intent was to predict the retention of cadmium in other species of animals (including humans) without requiring an adjustment of species-specific rate constants from within the model.

Male adult mice of the SW/NIH strain were dosed intravenously with ^{109}Cd as ^{109}Cd acetate. Mice received 1–3 intravenous injections spaced 48 hours apart. Animals in each group were sacrificed at 2 and 10 minutes and 1, 10, and 48 hours after the last dose. Tissues (liver, kidney, pancreas, spleen, gastrointestinal tract, testes, carcass, and feces) were harvested and the radioactivity recorded. A nine-compartment model was derived. Cadmium kinetics between compartments are described by first-order kinetics. The individual compartment retention values, obtained from the distribution study, were incorporated into the model equations and the rate constants derived.

3. HEALTH EFFECTS

Figure 3-5. A Schematic Representation of the Shank Model

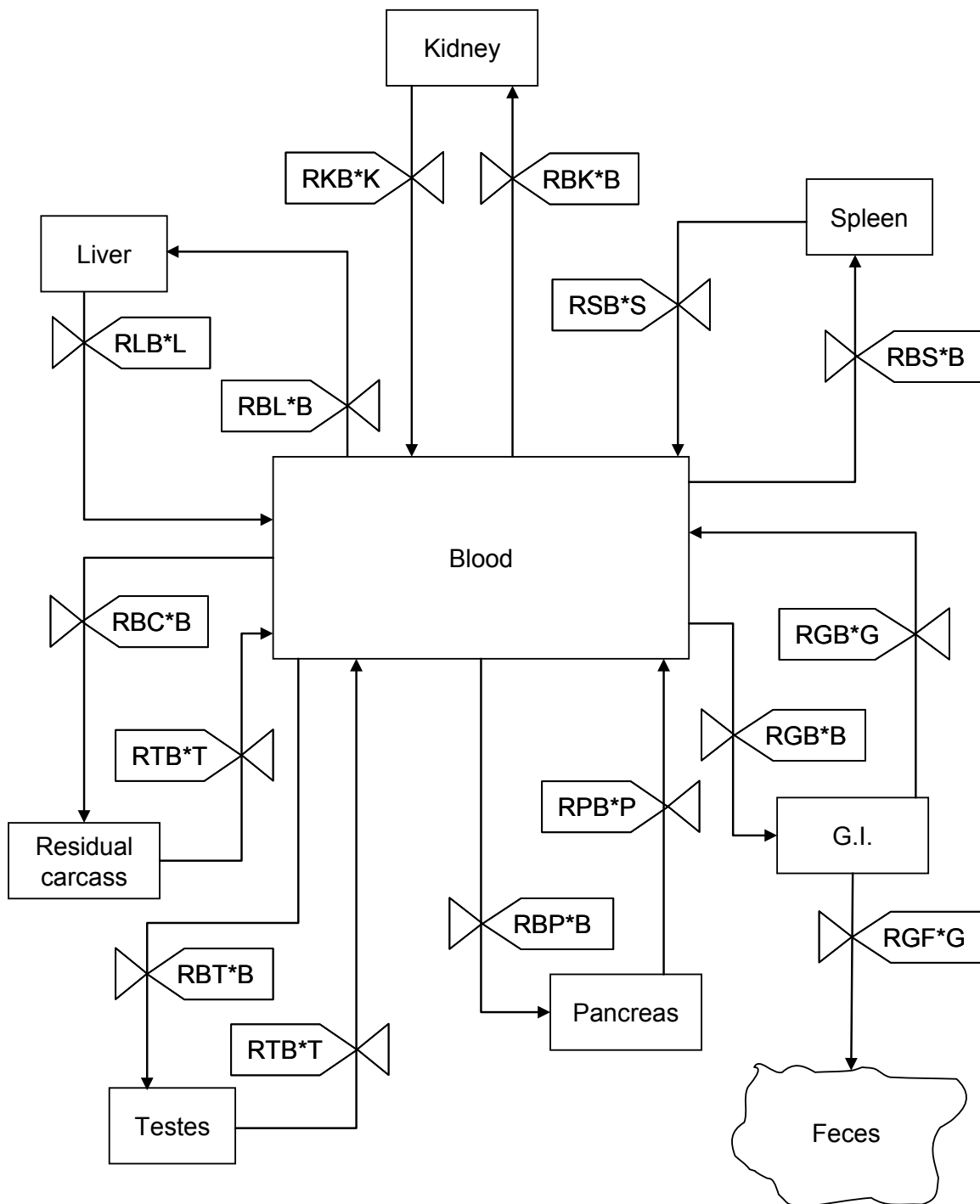

Source: Forrester 1968

3. HEALTH EFFECTS

Validation of the model. The Shank model was validated using three independent data sets. Mann (1973) dosed dogs, goats, and sheep with one intravenous injection of ^{109}Cd acetate (30 μCi), and the liver and kidneys were examined for cadmium content 8 weeks after administration. The Shank model's predicted values of cadmium retention in liver and kidneys at 8 weeks after a single administration were in good agreement with the observed values of the Mann (1973) study in all three species. Only data from the liver and kidneys were available for evaluation. A data set from a study by Gunn et al. (1968b) was used to evaluate the ability of the Shank model to predict the retention of cadmium in liver and kidney after a single subcutaneous administration of cadmium chloride. Animals in that study were sacrificed 2 weeks after administration, and the liver and kidneys were examined for cadmium content. The model values for the same time period were in very close agreement with observed values. Again, only data from the liver and kidneys were available for evaluation. Finally, a data set by Shanbaky (1973) was used to test the model's validity with multiple injections of cadmium acetate in rats. Five injections of cadmium acetate were administered over a 48-hour period; liver, kidneys, pancreas, spleen, and gastrointestinal tract were examined for cadmium content. The Shank model was found to be in close agreement with the arithmetic means of observed values found in the Shanbaky (1973) study.

No human data were presented to validate the model's effectiveness in predicting the cadmium retention in human target tissues after either a single or multiple dosing regime.

Target tissues. The target tissues for this model included the liver, kidney, pancreas, spleen, gastrointestinal tract, testes, and carcass of laboratory animals. No human tissue was used to derive cadmium retention in any of these tissues.

Species extrapolation. The model used goats, dogs, rats, mice, and sheep with various doses and dosing schemes of cadmium acetate and cadmium chloride and was found to serve as a good predictor of cadmium retention in the target tissues listed above. No human data were presented to determine if the model could satisfactorily predict the cadmium retention in human target tissues.

High-low dose extrapolation. High- and low-dose extrapolation was not specifically addressed by the Shank model.

Interroute extrapolation. Interroute extrapolations were addressed in a limited fashion by the Shank model. The model appeared to adequately predict the amount of cadmium retention in the target organs

3. HEALTH EFFECTS

of laboratory animals, in particular the liver and kidney, when dosed by either the intravenous or subcutaneous routes. The inhalation and dermal routes of exposure, and other parenteral routes of exposure (intramuscular, intraperitoneal, intradermal, etc.) were not addressed by the Shank model. No human data were presented to determine if interroute extrapolations were valid.

The Matsubara-Khan Model

Risk assessment. The Matsubara-Khan model (Matsubara-Khan 1974) has not been used as a tool in risk assessment for humans. This model does demonstrate that cadmium kinetics and biological half-lives vary by tissue.

Description of the model. The Matsubara-Khan model is a simple model that attempted to fit cadmium elimination kinetic parameters into either a one- or two-compartment model. To obtain the data for the model, male and female ICR mice (8 weeks of age) were administered a single subcutaneous injection of a known amount of ^{109}Cd cadmium chloride. Specific groups of mice were sacrificed at 1, 2, 4, 8, 16, 32, 64, or 128 days after injection. At the time of sacrifice, blood, liver, kidney, salivary gland, stomach wall and stomach contents, small intestine and small intestine contents, and colon wall and colon contents were removed and the amount of ^{109}Cd remaining in these tissues was determined.

An oral study was conducted in conjunction with the subcutaneous study described above. In the oral study, 8-week-old male mice (ddd x BALB/c; F₁) were orally administered $^{115\text{m}}\text{Cd}$ cadmium chloride by gavage. Groups of mice were sacrificed at 1, 2, 4, 8, 16, 32, 64, or 128 days after injection. At the time of sacrifice, liver, kidney, salivary gland, stomach wall, gonad, and spleen were removed and the amount of $^{115\text{m}}\text{Cd}$ remaining in these tissues was determined.

The rate of uptake, rate constants, and biological half-lives determined for the subcutaneous and orally dosed mice are summarized in [Table 3-13](#). Matsubara-Khan found that tissue kinetics in mice dosed subcutaneously with ^{109}Cd cadmium chloride fit into either a one- or two-compartment model, depending on the tissue. The data from the digestive tract organs (stomach wall, small intestine, and colon) were best fitted into a 1-compartment model, with a strained fit of the data from the digestive tract contents (stomach, small intestine, and colon contents) to the one-compartment model. Data from the blood, liver, kidneys, and salivary glands were best fitted to the two-compartment model. Extremely small second-rate constants in the kidneys and salivary glands indicate that the elimination of cadmium from these tissues is

3. HEALTH EFFECTS

Table 3-13. Estimated Parameters, Rate of Uptake, Rate Constants, and Biological Half-Lives in Selected Mouse Organs After Subcutaneous and Oral Administrations of $^{109}\text{CdCl}_2$

Organ	Rate of uptake (95% CL)		Rate constants b and c (95% CL)		Biological half-life (days)	
	SC	PO	SC	PO	SC	PO
Liver	21	8.7	0.011 0.57	0.016 0.91	631.2	430.76
Kidney	22	1.4	0.0007 0.30	0.016 0.30	9902.3	4332.3
Salivary gland	21	0.33	0.0016 0.73	0.0047 0.78	4330.95	1500.89
Blood	0.15	NM	0.024 0.65	NM	291.1	NM
Stomach wall	1.7	0.36	0.0073	0.017	95	41
Stomach contents	0.68	NM	0.062	NM	11	NM
Small intestine	0.95	NM	0.01	NM	69	NM
Small intestine contents	2.5	NM	0.067	NM	10	NM
Colon	1.4	NM	0.013	NM	53	NM
Colon contents	4.1	NM	0.15	NM	4.6	NM
Gonad	NM	0.37	NM	0.012	NM	58
Spleen	NM	0.44	NM	0.0011	NM	630

CL = confidence limits; PO = oral; SC = subcutaneous; NM = not measured

Source: Matsubara-Khan 1974

3. HEALTH EFFECTS

very slow. For the oral study, similar findings were observed, with data from the gonads and spleen fitting the one-compartment model best. Biological half-lives were invariably longer for the subcutaneously dosed animals, while the rate constants were slightly smaller for the subcutaneously dosed animals. Sex-related differences in rate of uptake, rate constants, and biological half-lives were not found, except in the kidney data in which females had slightly smaller rate constants.

Validation of the model. No independent data sets were used to validate the Matsubara-Khan model.

Target tissues. For the subcutaneous injection study, the Matsubara-Khan model used blood, liver, kidney, salivary gland, stomach wall and stomach contents, small intestine and small intestine contents, and colon wall and colon contents. For the oral study, the model used liver, kidney, salivary glands, stomach wall, gonads, and spleen.

Species extrapolation. No species extrapolations were performed in the Matsubara-Khan model.

High-low dose extrapolation. No high-low dose extrapolations were performed in the Matsubara-Khan model.

Interroute extrapolation. The Matsubara-Khan model compared the oral and subcutaneous routes and reported similar rate constants for many of the tissues examined. Biological half-lives varied considerably for the kidney and salivary gland, but were not much different for liver between the two routes of exposure.

3.5 MECHANISMS OF ACTION

3.5.1 Pharmacokinetic Mechanisms

Absorption. Cadmium can be absorbed by the inhalation, oral, and dermal routes of exposure regardless of its chemical form (chloride, carbonate, oxide, sulfide, sulfate, or other forms). Absorption by the dermal route of exposure, however, is relatively insignificant for cadmium, although small amounts are absorbed percutaneously over a long period of time (Wester et al. 1992). Absorption is mainly of concern from inhalation and oral exposures.

3. HEALTH EFFECTS

Gastrointestinal tract absorption of cadmium (in any chemical form) is relatively low when compared to the total amount of cadmium absorbed via the inhalation route. In humans, cadmium absorption has been reported to be approximately 1–10% ((Flanagan et al. 1978; McLellan et al. 1978; Newton et al. 1984; Rahola et al. 1973; Shaikh and Smith 1980; Vanderpool and Reeves 2001). In other species, gastrointestinal tract absorption of cadmium has been determined to be 1–2% in mice and rats (Decker et al. 1958; Ragan 1977), 0.5–3.0% in monkeys (Friberg et al. 1974), 2% in goats (Miller et al. 1969), 5% in pigs and lambs (Cousins et al. 1973; Doyle et al. 1974), and nearly 16% in cattle (Miller et al. 1967). Lehman and Klaassen (1986) investigated the dose-dependence of cadmium absorption and disposition in male Sprague-Dawley rats. Cadmium absorption was estimated to be 0.35 and 1% following oral exposure to 1 or 10,000 µg/kg, respectively. Goon and Klaassen (1989) measured absorption of cadmium in rat intestine *in situ* and reported that the intestinal absorption of cadmium is dosage independent at low dosages of cadmium (<10 µg/kg) and dosage dependent at high dosages (>10 µg/kg). They also evaluated the role of metallothionein and concluded that saturation of intestinal metallothionein is not a major determinant of the observed dosage-dependent absorption of cadmium.

Although the mechanism involved in the intestinal absorption of cadmium has not been fully elucidated, there is evidence that one or more transporter proteins are involved. Several studies have found evidence that divalent metal transporter I protein plays an important role in the gastrointestinal absorption of cadmium (Kim et al. 2007; Park et al. 2002; Ryu et al. 2004). However, studies in knockout mice suggest that other transporter proteins are involved with cadmium absorption (Min et al. 2008; Ryu et al. 2004; Suzuki et al. 2007).

In some cases, cadmium bound to metallothionein (as in food) is not absorbed or distributed from the gastrointestinal tract as readily as ionic cadmium. Mice had lower blood and liver cadmium levels from oral exposure to cadmium-metallothionein, compared to levels from cadmium chloride exposure for comparable doses, but the cadmium-metallothionein resulted in higher kidney cadmium levels. Sharma et al. (1983) reported that human exposure to very high intakes of cadmium during the consumption of oysters resulted in increases in whole blood and urine cadmium levels; however, the increase was not proportional to the level of intake.

A higher fraction of inhaled cadmium than ingested cadmium is absorbed. The total amount of cadmium absorbed by the body via the lungs depends on the particle size. Larger particles are deposited in the nasopharyngeal and tracheobronchial airways via impaction, and are largely cleared by mucociliary processes, leading to absorption by the gastrointestinal tract. Smaller particles reach the smaller airways

3. HEALTH EFFECTS

and alveoli, and depending on the particle's solubility, are absorbed and distributed to the rest of the body. Solubility in lung fluids plays a role in absorption from the lung into the body of cadmium salts.

Theoretically, the highly soluble salts, chloride, nitrate, acetate, and sulfate would be expected to give the highest blood levels following inhalation exposure to a given air concentration. The insoluble cadmium salts, the various sulfides, should yield the lowest blood level. The lung, however, is rich in carbon dioxide that is continuously transferred from the blood. Particles of the various cadmium sulfides within the lung can react with this carbon dioxide. Lung tissue may then absorb and transfer solubilized or released cadmium ions to the blood.

No direct data, however, are available on cadmium deposition, retention, or absorption in the human lung. Data from animal studies indicate that lung retention is greatest after short-term exposure, 5–20% after 15 minutes to 2 hours (Barrett et al. 1947; Henderson et al. 1979; Moore et al. 1973; Rusch et al. 1986). The initial lung burden declines slowly after exposure ceases (Henderson et al. 1979; Moore et al. 1973; Rusch et al. 1986), due to the absorption of cadmium and the lung clearance of deposited particles. After longer periods of inhalation exposure to cadmium, somewhat lower lung retentions are found (Glaser et al. 1986). The absorption of cadmium in the lung differs somewhat among chemical forms, but the pattern apparently does not correlate well with solubility in water (Glaser et al. 1986; Rusch et al. 1986). Retention of cadmium has been reported to be >40% in rats (Moore et al. 1973), 40% in canines (Friberg et al. 1974), and 10–20% in mice (Potts et al. 1950).

The cadmium levels in cigarettes range from 0.28 to 3.38 μg (Elinder et al. 1985b; Watanabe et al. 1987); the mean in 38 U.S. brands was 1.07 μg (Watanabe et al. 1987). Approximately 10% of the cadmium in cigarettes is inhaled (Elinder et al. 1985b). Based on comparison of cadmium body burdens in human smokers and nonsmokers, cadmium absorption from cigarettes appears to be higher than absorptions of cadmium aerosols measured in animals (Nordberg et al. 1985). The chemical form of cadmium in cigarette smoke is likely to be similar to that produced by other combustion processes, primarily cadmium oxide aerosols. The greater absorption of cadmium from cigarette smoke is likely due to the very small size of particles in cigarette smoke and the consequent very high alveolar deposition (Nordberg et al. 1985).

Distribution and Metabolism. Absorbed cadmium is distributed throughout the body, with the highest concentrations found in the liver and kidneys. Cadmium is not known to undergo direct metabolic conversions. It has a high affinity for the sulfhydryl groups of albumin and metallothionein (Nordberg et al. 1985). The interaction between cadmium and metallothionein plays a critical role in the

3. HEALTH EFFECTS

toxicokinetics and toxicity, as discussed in Section 3.5.2, of cadmium. Metallothionein sequesters a large fraction of tissue cadmium (Shaikh 1982) and studies in metallothionein transgenic and metallothionein-null mice suggest that metallothionein influences tissue retention, but may not affect cadmium distribution to the liver, kidney, pancreas, or spleen (Liu and Klaassen 1996; Liu et al. 1996; Wong and Klaassen 1980a). Metallothionein turns over with half-lives of 2.8 days in the rat liver and 5 days in the kidney (Shaikh and Smith 1976); however, cadmium is retained in both organs bound mainly to metallothionein. It has a retention half-time of 73 days in the liver and a life-time in the kidneys (Shaikh 1982).

Shaikh et al. (1993) report that disposition of cadmium in mouse liver, kidney, and testes is different for different strains, sex, or age. Different dose levels (i.e., subcutaneous doses in the 5–30 $\mu\text{mol/kg}$ body weight range) also altered the disposition. Liver cadmium levels and metallothionein levels did not always correlate with hepatotoxicity. The difference in the tissue accumulation of cadmium may relate to variations in the hormonal or other intrinsic factors that affect cellular uptake of cadmium, subcellular distribution of cadmium, or metallothionein metabolism.

Excretion. Since a small fraction of the cadmium presented to the gastrointestinal tract is absorbed, most of the oral dose is excreted via the feces. After inhalation exposure to cadmium, the initial lung burden of cadmium-laden particles depositing in the nasopharyngeal or central airways will be cleared via the mucociliary mechanisms, possibly undergoing a small amount of absorption by the oral route. The remaining cadmium particles will be absorbed in the lung. Once absorbed cadmium has distributed throughout the body (primarily to the liver and kidney), the amounts of fecal and urinary excretion of cadmium are approximately equal. The amount of cadmium in the urine of occupationally exposed workers increases proportionally with body burden of cadmium, but the amount of cadmium excreted represents only a small fraction of the total body burden unless renal damage is present; in this case, urinary cadmium excretion increases markedly (Roels et al. 1981b).

Klaassen and Kotsonis (1977) evaluated biliary excretion of an intravenous bolus of cadmium chloride in the rat, rabbit, and dog. Marked species variation in biliary excretion was observed with rabbits at about 1/6th the rate of the rats, and dogs about 1/300th the rate of the rats. In the rat, the bile/plasma concentration ratio of cadmium was highly dose dependent, increasing with higher dose; at 0.1 mg/kg, the bile/plasma ratio was 2.6 and at 3.0 mg/kg, the bile/plasma ratio was 133. The bile/liver concentration ratio of cadmium was equal to or much lower than 1 decreasing to <1% for the low dose regimen.

3. HEALTH EFFECTS

3.5.2 Mechanisms of Toxicity

Cadmium is toxic to a wide range of organs and tissues; however, the primary target organs of cadmium toxicity are the kidneys; bone and lung (following inhalation exposure) are also sensitive targets of toxicity. Changes in the kidney due to cadmium toxicity have been well established. Chronic exposure to cadmium by the oral or inhalation routes has produced proximal tubule cell damage, proteinuria (mainly low-molecular weight proteins, such as β 2-microglobulin), glycosuria, amino aciduria, polyuria, decreased absorption of phosphate, and enzymuria in humans and in a number of laboratory animal species. The clinical symptoms result from the degeneration and atrophy of the proximal tubules, or (in worse cases) interstitial fibrosis of the kidney (Stowe et al. 1972). Cadmium has been shown to perturb lipid composition and enhance lipid peroxidation (Gill et al. 1989b). Depletion of antioxidant enzymes, specifically glutathione peroxidase and superoxide dismutase, has been proposed as the mechanism of cadmium's cardiotoxic effects (Jamall and Smith 1985a), but subsequent studies showed that cardiotoxic mechanisms other than peroxidation are also present (Jamall et al. 1989). Cadmium has been shown to alter zinc, iron and copper metabolism (Petering et al. 1979) as well as selenium (Jamall and Smith 1985b). Xu et al. (1995) propose that an initiating step in cadmium-induced toxicity to the testes is cadmium interference with zinc-protein complexes that control DNA transcription which subsequently leads to apoptosis. Cadmium sequestration by metallothionein (or a chelator in the case of the Xu et al. [1995] study) prevents cadmium from disrupting zinc-dependent transcriptional controls.

Cardenas et al. (1992a) investigated a cadmium-induced depletion of glomerular membrane polyanions and the resulting increased excretion of high-molecular-weight proteins. Interference with glomerular membrane polyanionic charge may precede the tubular damage as a more sensitive and early response to cadmium (Roels et al. 1993). Acute or chronic doses of cadmium have also been reported to reduce hepatic glycogen stores and to increase blood glucose levels. Intralobular fibrosis, cirrhosis, focal mononuclear infiltrates, and proliferation of the smooth endoplasmic reticulum are among the nonspecific histopathological indicators of cadmium toxicity.

Cadmium complexed with metallothionein from the liver can redistribute to the kidney (Dudley et al. 1985). When metallothionein-bound cadmium is transported to the kidney, it readily diffuses and is filtered at the glomerulus, and may be effectively reabsorbed from the glomerular filtrate by the proximal tubule cells (Foulkes 1978). In the kidneys, exogenous metallothionein is degraded in lysosomes and released cadmium is sequestered by the endogenous metallothionein as well as other proteins (Cherian

3. HEALTH EFFECTS

and Shaikh 1975; Squibb et al. 1984; Vestergaard and Shaikh 1994). This non-metallothionein-bound cadmium can then induce new metallothionein synthesis in the proximal tubule (Squibb et al. 1984).

Early work indicated that metallothionein binding decreased the toxicity of cadmium, and the ability of the liver to synthesize metallothionein appeared to be adequate to bind all the accumulated cadmium (Goyer et al. 1989; Kotsonis and Klaassen 1978). The rate of metallothionein synthesis in the kidney is lower than in the liver (Sendelbach and Klaassen 1988), and is thought to be insufficient, at some point, to bind the intrarenal cadmium (Kotsonis and Klaassen 1978). Renal damage is believed to occur when the localization of cadmium, or an excessive concentration of cadmium, is unbound to metallothionein. Acute exposure to low levels of cadmium bound to metallothionein produced an intracellular renal damage as described above (Squibb et al. 1984), but damage to brush-border membranes of the renal tubule has also been reported from metallothionein-bound cadmium (Suzuki and Cherian 1987) suggesting other toxic mechanisms may be present.

Dorian et al. (1992a) evaluated the intra-renal distribution of ^{109}Cd -metallothionein injected (intravenously) into male Swiss mice at a nonnephrotoxic dose (0.1 mg Cd/kg) and concluded that cadmium-metallothionein-induced nephrotoxicity might be due, at least in part, to its preferential uptake of cadmium-metallothionein into the S1 and S2 segments of the proximal tubules, the site of cadmium-induced nephrotoxicity. In a companion study, Dorian et al. (1992b) reported that this preferential renal uptake was also observed after administration of various doses of [^{35}S]cadmium-metallothionein. In contrast to the earlier observed persistency of ^{109}Cd in the kidney after ^{109}Cd -metallothionein administration, however, ^{35}S disappeared rapidly (with a half-life of approximately 2 hours); 24 hours after injection of [^{35}S]cadmium-metallothionein, there was very little ^{35}S left in the kidneys. These observations indicate that the protein portion of cadmium-metallothionein is rapidly degraded after renal uptake of cadmium metallothionein and that the released cadmium is retained in the kidney.

The toxic effects and distribution of cadmium were compared after intravenous injection of ^{109}Cd -metallothionein at 0.05–1 mg Cd/kg body weight and ^{109}Cd chloride at 0.1–3 mg/kg in male Swiss mice (Dorian et al. 1995). Cadmium-metallothionein increased urinary excretion of glucose, and protein indicated renal injury, with dosages as low as 0.2 mg Cd/kg. In contrast, renal function was unaltered by cadmium chloride administration, even at dosages as high as 3 mg Cd/kg. Cadmium-metallothionein distributed almost exclusively to the kidney, whereas cadmium chloride preferentially distributed to the liver. However, a high concentration of cadmium was also found in the kidneys after cadmium chloride administration (i.e., the renal cadmium concentration after administration of a high but nonnephrotoxic

3. HEALTH EFFECTS

dose of cadmium chloride was equal to or higher than that obtained after injection of nephrotoxic doses of cadmium-metallothionein). Light microscopic autoradiography studies indicated that cadmium from cadmium-metallothionein preferentially distributed to the convoluted segments (S1 and S2) of the proximal tubules, whereas cadmium from cadmium chloride distributed equally to the various segments (convoluted and straight) of the proximal tubules. However, the concentration of cadmium at the site of nephrotoxicity, the proximal convoluted tubules, was higher after cadmium chloride than after cadmium-metallothionein administration. A higher cadmium concentration in both apical and basal parts of the proximal cells was found after cadmium chloride than after cadmium-metallothionein administration. The authors suggest that cadmium-metallothionein is nephrotoxic, and cadmium chloride is not nephrotoxic because of a higher concentration of cadmium in the target cells after cadmium-metallothionein. Dorian and Klaassen (1995) evaluated the effects of zinc-metallothionein on ¹⁰⁹cadmium-metallothionein renal uptake and nephrotoxicity and concluded that zinc-metallothionein is not only nontoxic to the kidney at a dose as high as 5 µmole metallothionein/kg, but it can also protect against the nephrotoxic effect of cadmium-metallothionein without decreasing renal cadmium concentration.

To further test the hypothesis that nephrotoxicity produced from chronic cadmium exposure results from a cadmium-metallothionein complex, Liu et al. (1998) exposed metallothionein-null mice to a wide range of cadmium chloride doses, 6 times/week for up to 10 weeks. Renal cadmium burden increased with dose and duration up to 140 µg Cd/g kidney in control mice (i.e., metallothionein normal) with a 150-fold increase in renal metallothionein levels (800 µg metallothionein/g kidney). Renal cadmium was much lower in metallothionein-null mice (10 µg Cd/g), and metallothionein levels were not detectable. The maximum tolerated dose of cadmium (as indicated by routine urinalysis and histopathology measures) was approximately 8 times higher in control mice than in metallothionein-null mice. Lesions were more severe in metallothionein-null mice than in controls.

The critical concentration of cadmium in the renal cortex that is likely to produce renal dysfunction also remains a topic of intense investigation. Whether the critical concentration of urinary cadmium is closer to 5 or 10 µg Cd/g creatinine, corresponding to about 100 and 200 µg cadmium/g kidney, respectively, is the current focus of the debate. In one analysis, the critical concentration producing dysfunction in 10% of a susceptible population has been estimated to be approximately 200 µg cadmium/g kidney; 50% of the susceptible population would experience dysfunction with a kidney concentration of 300 µg/g (Ellis et al. 1984, 1985; Roels et al. 1983).

3. HEALTH EFFECTS

Studies in humans and animals have demonstrated that the bone is a sensitive target of cadmium toxicity. It is likely that cadmium acts by direct and indirect mechanisms, which can lead to decreased bone mineral density and increased fractures (Brzóška and Moniuszko-Jakoniuk 2005c, 2005d). Studies in young animals suggest that cadmium inhibits osteoblastic activity, resulting in a decrease in the synthesis of bone organic matrix and mineralization (Brzóška and Moniuszko-Jakoniuk 2005d). The decreased osteoblastic activity may also influence osteoclastic activity leading to increased bone resorption. During intense bone growth, effects on osteoblasts result in decreased bone formation; after skeletal maturity, cadmium exposure results in increased bone resorption. Cadmium-induced renal damage can also result in secondary effects on bone (Brzóška and Moniuszko-Jakoniuk 2005c). Cadmium-induced renal damage interferes with the hydroxylation of 25-hydroxy-vitamin D to form 1,25-dihydroxy-vitamin D. Decreased serum concentration of 1,25-dihydroxy-vitamin D, along with impaired kidney resorptive function, result in calcium and phosphate deficiency (via decreased gastrointestinal absorption and increased calcium and phosphate urinary loss). To maintain calcium and phosphate homeostasis, parathyroid hormone is released, which enhances bone resorption.

3.5.3 Animal-to-Human Extrapolations

The effects of cadmium exposure have been studied in humans and in many laboratory animal species. The target organs are similar among species, with the kidneys, bone, and lungs (inhalation only) being the primary organs for cadmium induced toxicity. Absorption, distribution, and excretion of cadmium after oral and inhalation exposures are roughly similar among species; however, there are some notable differences and caveats. Most estimates of cadmium absorption in animals are somewhat lower than the values found from human studies, particularly after prolonged exposure. Differences in the breathing patterns between rats (obligatory nose breathers) and humans (mouth and nose breathers) may also result in radically different lung burden patterns (and hence, different absorption profiles) of cadmium particles in the lungs. Many of the common laboratory animals (in particular the mouse and rat) provide useful information on the toxic effects of cadmium; due to their relatively short lifespan, however, they may not be as useful from a risk assessment point of view in determining the human lifetime effects from inhaling cadmium in air, or ingesting it in food and water. Rates of synthesis and inducibility of metallothionein also differ among species, sex, and target organ.

Even within species there can be significant differences in metallothionein synthesis, and these differences correlate to the degree of cadmium toxicity observed (e.g., the mouse) (Shaikh et al. 1993). The Shaikh et al. (1993) study employed acute exposures. Strain differences in carcinogenic effects have

3. HEALTH EFFECTS

also been reported for chronic exposures of subcutaneously administered cadmium chloride in male DBA and NFS mice. DBA mice developed lymphomas, while NFS mice developed hepatocellular adenomas and carcinomas, and sarcomas at the injection site. Both strains developed nonneoplastic testicular lesions (fibrosis and mineralization) (Waalkes and Rhem 1992).

Metal-metal interactions are also an important factor in cadmium kinetics and toxicity, and organ specific metal concentrations and metabolism can differ among species. It is thought that further development of PBPK/PD models will assist in addressing these differences and in extrapolating the animal data to support risk assessments in humans.

3.6 TOXICITIES MEDIATED THROUGH THE NEUROENDOCRINE AXIS

Recently, attention has focused on the potential hazardous effects of certain chemicals on the endocrine system because of the ability of these chemicals to mimic or block endogenous hormones. Chemicals with this type of activity are most commonly referred to as *endocrine disruptors*. However, appropriate terminology to describe such effects remains controversial. The terminology *endocrine disruptors*, initially used by Thomas and Colborn (1992), was also used in 1996 when Congress mandated the EPA to develop a screening program for "...certain substances [which] may have an effect produced by a naturally occurring estrogen, or other such endocrine effect[s]...". To meet this mandate, EPA convened a panel called the Endocrine Disruptors Screening and Testing Advisory Committee (EDSTAC), and in 1998, the EDSTAC completed its deliberations and made recommendations to EPA concerning *endocrine disruptors*. In 1999, the National Academy of Sciences released a report that referred to these same types of chemicals as *hormonally active agents*. The terminology *endocrine modulators* has also been used to convey the fact that effects caused by such chemicals may not necessarily be adverse. Many scientists agree that chemicals with the ability to disrupt or modulate the endocrine system are a potential threat to the health of humans, aquatic animals, and wildlife. However, others think that endocrine-active chemicals do not pose a significant health risk, particularly in view of the fact that hormone mimics exist in the natural environment. Examples of natural hormone mimics are the isoflavonoid phytoestrogens (Adlercreutz 1995; Livingston 1978; Mayr et al. 1992). These chemicals are derived from plants and are similar in structure and action to endogenous estrogen. Although the public health significance and descriptive terminology of substances capable of affecting the endocrine system remains controversial, scientists agree that these chemicals may affect the synthesis, secretion, transport, binding, action, or elimination of natural hormones in the body responsible for maintaining homeostasis, reproduction, development, and/or behavior (EPA 1997a). Stated differently, such compounds may cause toxicities that

3. HEALTH EFFECTS

are mediated through the neuroendocrine axis. As a result, these chemicals may play a role in altering, for example, metabolic, sexual, immune, and neurobehavioral function. Such chemicals are also thought to be involved in inducing breast, testicular, and prostate cancers, as well as endometriosis (Berger 1994; Giwercman et al. 1993; Hoel et al. 1992).

No studies were located regarding endocrine disruption in humans and/or animals after exposure to cadmium.

No *in vitro* studies were located regarding endocrine disruption of cadmium.

3.7 CHILDREN'S SUSCEPTIBILITY

This section discusses potential health effects from exposures during the period from conception to maturity at 18 years of age in humans, when all biological systems will have fully developed. Potential effects on offspring resulting from exposures of parental germ cells are considered, as well as any indirect effects on the fetus and neonate resulting from maternal exposure during gestation and lactation. Relevant animal and *in vitro* models are also discussed.

Children are not small adults. They differ from adults in their exposures and may differ in their susceptibility to hazardous chemicals. Children's unique physiology and behavior can influence the extent of their exposure. Exposures of children are discussed in Section 6.6, Exposures of Children.

Children sometimes differ from adults in their susceptibility to hazardous chemicals, but whether there is a difference depends on the chemical (Guzelian et al. 1992; NRC 1993). Children may be more or less susceptible than adults to health effects, and the relationship may change with developmental age (Guzelian et al. 1992; NRC 1993). Vulnerability often depends on developmental stage. There are critical periods of structural and functional development during both prenatal and postnatal life, and a particular structure or function will be most sensitive to disruption during its critical period(s). Damage may not be evident until a later stage of development. There are often differences in pharmacokinetics and metabolism between children and adults. For example, absorption may be different in neonates because of the immaturity of their gastrointestinal tract and their larger skin surface area in proportion to body weight (Morselli et al. 1980; NRC 1993); the gastrointestinal absorption of lead is greatest in infants and young children (Ziegler et al. 1978). Distribution of xenobiotics may be different; for example, infants have a larger proportion of their bodies as extracellular water, and their brains and livers are

3. HEALTH EFFECTS

proportionately larger (Altman and Dittmer 1974; Fomon 1966; Fomon et al. 1982; Owen and Brozek 1966; Widdowson and Dickerson 1964). The infant also has an immature blood-brain barrier (Adinolfi 1985; Johanson 1980) and probably an immature blood-testis barrier (Setchell and Waites 1975). Many xenobiotic metabolizing enzymes have distinctive developmental patterns. At various stages of growth and development, levels of particular enzymes may be higher or lower than those of adults, and sometimes unique enzymes may exist at particular developmental stages (Komori et al. 1990; Leeder and Kearns 1997; NRC 1993; Vieira et al. 1996). Whether differences in xenobiotic metabolism make the child more or less susceptible also depends on whether the relevant enzymes are involved in activation of the parent compound to its toxic form or in detoxification. There may also be differences in excretion, particularly in newborns who all have a low glomerular filtration rate and have not developed efficient tubular secretion and resorption capacities (Altman and Dittmer 1974; NRC 1993; West et al. 1948). Children and adults may differ in their capacity to repair damage from chemical insults. Children also have a longer remaining lifetime in which to express damage from chemicals; this potential is particularly relevant to cancer.

Certain characteristics of the developing human may increase exposure or susceptibility, whereas others may decrease susceptibility to the same chemical. For example, although infants breathe more air per kilogram of body weight than adults breathe, this difference might be somewhat counterbalanced by their alveoli being less developed, which results in a disproportionately smaller surface area for alveolar absorption (NRC 1993).

Occupational and environmental exposure studies in adults provide strong evidence that the lung (inhalation exposure only) and kidneys are sensitive targets of toxicity; it is likely that these effects would also be seen in children. Because cadmium is a cumulative toxin and has a very long half-time in the body, exposures to children in even low amounts may have long-term adverse consequences. Average cadmium concentrations in the kidney are near zero at birth, and rise roughly linearly with age to a peak (typically around 40–50 $\mu\text{g/g}$ wet weight) between the ages of 50 and 60 years, after which kidney concentrations plateau or decline (Chung et al. 1986; Hammer et al. 1973; Lauwerys et al. 1984). There are limited data on the renal toxicity of cadmium in children. One study found significant associations between urinary and blood cadmium levels with urinary levels of NAG and retinol binding protein (de Burbure et al. 2006); however, the investigators cautioned that the early response observed in this group of children exposed to elevated levels of cadmium (and other metals) may reflect an early renal response that may be adaptive and/or reversible. Another study (Trzcinka-Ochocka et al. 2004) found higher urinary concentrations of β 2-microglobulin and retinol binding protein in a population exposed to high

3. HEALTH EFFECTS

levels of cadmium starting in childhood as compared to a group only exposed as adults even though urinary cadmium levels were lower (statistical comparisons of urinary cadmium levels were not made between the groups). These data suggest that adults exposed to cadmium as children may be more susceptible to the renal toxicity of cadmium than persons only exposed as adults. This is supported by the findings of Jacquillet et al. (2007) of renal damage in mature rats exposed to cadmium via gestation and lactation.

There are epidemiological data suggesting that the bone is also a sensitive target of cadmium toxicity (Åkesson et al. 2005; Alfvén et al. 2000, 2002a, 2004; Aoshima et al. 2003; Jin et al. 2004b; Nordberg et al. 2002; Staessen et al. 1999; Wang et al. 2003; Zhu et al. 2004). Epidemiology studies suggest that the elderly may be more susceptible than younger adults; however, no studies examined childhood exposure. Animal studies suggest that young animals are more susceptible than adult or elderly animals (Ogoshi et al. 1989).

A potential for cadmium to have adverse neurological effects is an important consideration. However, only a few studies have reported an association between environmental cadmium exposure and neuropsychological functioning. End points that were affected included verbal IQ in rural Maryland children (Thatcher et al. 1982), and acting-out and distractibility in rural Wyoming children (Marlowe et al. 1985). The usefulness of the data from these studies is limited, however, because of the potential confounding effects of lead exposure; lack of control for other possible confounders including home environment, caregiving, and parental IQ levels; and inadequate quantification of cadmium exposure (i.e., the studies used hair cadmium as an index of exposure, which has some limitations because of potential confounding from exogenous sources). Several animal studies have reported alterations in performance on neurobehavioral tests in rats exposed to cadmium via gestation and lactation (Ali et al. 1986; Baranski et al. 1983; Desi et al. 1998; Nagymajtenyi et al. 1997). Several studies have examined the possible association between cadmium exposure and newborn birth weight, and most reliable studies have not found a significant association (Galicía-García et al. 1997; Mokhtar et al. 2002; Nishijo et al. 2002, 2004b; Zhang et al. 2004). Animal studies have found significant decreases in body weight or skeletal anomalies or malformations in the offspring of rats exposed to high doses of cadmium (Ali et al. 1986; Baranski 1985, 1987; Gupta et al. 1993; Kelman et al. 1978; Kostial et al. 1993; Machermer and Lorke 1981; Petering et al. 1979; Pond and Walker 1975; Schroeder and Mitchener 1971; Sorell and Graziano 1990; Sutou et al. 1980; Webster 1978; Whelton et al. 1988).

3. HEALTH EFFECTS

Oral cadmium exposure has also been reported to suppress the T-lymphocyte and macrophage-dependent humoral immune response of 6-week-old mice against sheep red blood cells (Blakley 1985), but not of 12-month-old mice (Blakley 1988). The investigators cautioned that “natural” age-related immune system dysfunction may have masked any cadmium suppressive effect.

Children are most likely to be exposed to cadmium in food or water. Most ingested cadmium passes through the gastrointestinal tract without being absorbed. In adults, only about 1/20 of the total ingested cadmium (in food or water) is absorbed (McLellan et al. 1978, Rahola et al. 1973; Shaikh and Smith 1980). The retention of cadmium in the gut slowly decreases over a period of 1–3 weeks after ingestion in adults (Rahola et al. 1973). The absorption of cadmium in rats depends on age, with measured absorption decreasing from 12 to 5 to 0.5% at 2 hours, 24 hours, and 6 weeks after birth, respectively (Sasser and Jarboe 1977). Sasser and Jarboe (1980) also reported that absorption of cadmium in the gastrointestinal tract of young guinea pigs was 20-fold higher than in adult guinea pigs.

Tissue distribution and retention of cadmium differed between 4- and 70-day-old rats. Cadmium was 3–6 times more concentrated in the newborn spleen, bone, brain, testes, and muscle than in the adult rat 2 hours after an intravenous administration of 1 mg Cd/kg body weight. Liver concentration of metallothionein was 20 times greater in the newborn than in the adult; kidney metallothionein concentrations were comparable, but liver cadmium was only 30% higher and kidney cadmium was 50% higher in the newborn. Nineteen days post-cadmium exposure, the retention of cadmium in the liver, kidney, and lung was similar in both the newborn and the adult rat (Wong and Klaassen 1980a). Goering and Klaassen (1984b) report that high levels of metallothionein in 10-day-old rats play an important role in their resistance to liver damage, presumably by binding and retaining cadmium. However, the tissue distribution data led Wong and Klaassen (1980a) to propose that metallothionein does not play a major role in the tissue distribution and retention of cadmium in the young.

Cadmium can be transferred to offspring in breast milk. Cadmium levels in human milk are 5–10% of levels in blood, possibly due to inhibited transfer from blood because of metallothionein binding of cadmium in blood cells (Radisch et al. 1987). A significant association between urinary cadmium levels and cadmium levels in breast milk was found in women environmentally exposed to cadmium (Nishijo et al. 2002). In female outbred albino rats exposed to cadmium in drinking water (as cadmium chloride) at 0 or 4.8 mg/kg/day for 10 weeks (at 4 weeks prior to mating, 3 weeks of gestation, or 3 weeks into lactation), kidney concentrations exceeded liver concentrations, while in their pups, the renal and liver concentrations were similar at all times during exposure. In pups, both hepatic and renal cadmium

3. HEALTH EFFECTS

concentrations considerably increased only during the second half of the lactation period (Ld 11–21). The cadmium tissue concentrations in dams were several orders higher than in offspring. Another study found a positive correlation between cadmium levels in breast milk and cadmium levels in the pups' kidneys in rats receiving an intravenous injection of cadmium on lactation days 3–16 (Petersson Grawé and Oskarsson 2000).

Although studies on elimination of cadmium from the tissues of children are not available, the results of studies in animals provide some insight. Most cadmium that is ingested or inhaled and transported to the gut via mucociliary clearance is excreted in the feces. Of the cadmium that is absorbed into the body, most is excreted very slowly, with urinary and fecal excretion being approximately equal (Kjellström and Nordberg 1978). Half-times for cadmium in the whole body of mice, rats, rabbits, and monkeys have been calculated to be from several months up to several years (Kjellström and Nordberg 1985). Half-times in the slowest phase were 20–50% of the maximum life span of the animal (Kjellström and Nordberg 1985). In the human body, the main portion of the cadmium body burden is found in the liver and kidney and in other tissues (particularly muscle, skin, and bone). After reviewing the literature, Kjellström and Nordberg (1985) developed a range of half-times from their kinetic model of between 6 and 38 years for the human kidney and between 4 and 19 years for the human liver. These high values indicate the persistence of cadmium in the body and the importance of minimizing exposures in children to prevent long-term accumulation and toxicity.

The placenta may act as a partial barrier to fetal exposure to cadmium. Cadmium concentration has been found to be approximately half as high in cord blood as in maternal blood in several studies including both smoking and nonsmoking women (Kuhnert et al. 1982; Lauwerys et al. 1978; Truska et al. 1989). Accumulation of cadmium in the placenta at levels about 10 times higher than maternal blood cadmium concentration has been found in studies of women in Belgium (Roels et al. 1978) and the United States (Kuhnert et al. 1982); however, in another study in Czechoslovakia, the concentration of cadmium in the placenta was found to be less than in either maternal or cord blood (Truska et al. 1989). In mice orally exposed to cadmium during pregnancy, maternal blood, placental, and fetal cadmium concentrations were essentially equal among control animals (with environmental cadmium exposure), but placental concentration increased with cadmium dose much more rapidly than either maternal blood or fetal cadmium concentration (Sorell and Graziano 1990). Thus, timing and level of cadmium exposure may influence the uptake of cadmium by the placenta, perhaps explaining the conflicting human studies.

3. HEALTH EFFECTS

Of particular importance to the toxicokinetics and toxicity of cadmium is its interaction with the protein metallothionein. Metallothionein is a low-molecular-weight protein, very rich in cysteine, which is capable of binding as many as seven cadmium atoms per molecule and is inducible in most tissues by exposure to cadmium, zinc, and other metals (Waalkes and Goering 1990). Metallothionein binding decreases the toxicity of cadmium (Goyer et al. 1989; Kotsonis and Klaassen 1978). Goyer and Cherian (1992) localized metallothionein in full-term human placenta and in fetal cells in human placenta. Metallothionein was present in trophoblasts (which facilitate transport of substances entering the placenta from the maternal blood), Hofbauer cells (motile macrophages capable of phagocytosis and protein ingestion), amniotic epithelial cells (fetal derivatives), and decidual cells (endometrial stromal cells that have been transformed under hormonal influence into large pale cells, rich in glycogen). The mechanism by which the placenta transports the essential metals, copper and zinc, while limiting the transport of cadmium is unknown, but may involve the approximately 1,000-fold higher concentration of zinc in the placenta and the higher affinity of cadmium than zinc for metallothionein.

Chan and Cherian (1993) report that pregnancy in Sprague-Dawley rats previously administered cadmium chloride (1.0 mg Cd/kg body weight subcutaneously, daily for 8 days) leads to a mobilization of cadmium from the liver (40% decrease compared to nonpregnant cadmium treated controls) and an increase in the kidneys (60% increase). A similar pattern is seen for metallothionein. Plasma cadmium and metallothionein also increased in the pregnant group. Placental cadmium increased in the cadmium-treated rats compared to the untreated controls. In this rat model, then, pregnancy resulted in a transfer of hepatic cadmium and metallothionein via the blood to the kidney and placenta.

3.8 BIOMARKERS OF EXPOSURE AND EFFECT

Biomarkers are broadly defined as indicators signaling events in biologic systems or samples. They have been classified as markers of exposure, markers of effect, and markers of susceptibility (NAS/NRC 1989).

The National Report on Human Exposure to Environmental Chemicals provides an ongoing assessment of the exposure of the U.S. population to environmental chemicals using biomonitoring. This report is available at <http://www.cdc.gov/exposurereport/>. The biomonitoring data for cadmium from this report is discussed in Section 6.5. A biomarker of exposure is a xenobiotic substance or its metabolite(s) or the product of an interaction between a xenobiotic agent and some target molecule(s) or cell(s) that is measured within a compartment of an organism (NAS/NRC 1989). The preferred biomarkers of exposure

3. HEALTH EFFECTS

are generally the substance itself, substance-specific metabolites in readily obtainable body fluid(s), or excreta. However, several factors can confound the use and interpretation of biomarkers of exposure. The body burden of a substance may be the result of exposures from more than one source. The substance being measured may be a metabolite of another xenobiotic substance (e.g., high urinary levels of phenol can result from exposure to several different aromatic compounds). Depending on the properties of the substance (e.g., biologic half-life) and environmental conditions (e.g., duration and route of exposure), the substance and all of its metabolites may have left the body by the time samples can be taken. It may be difficult to identify individuals exposed to hazardous substances that are commonly found in body tissues and fluids (e.g., essential mineral nutrients such as copper, zinc, and selenium). Biomarkers of exposure to cadmium are discussed in Section 3.8.1.

Biomarkers of effect are defined as any measurable biochemical, physiologic, or other alteration within an organism that, depending on magnitude, can be recognized as an established or potential health impairment or disease (NAS/NRC 1989). This definition encompasses biochemical or cellular signals of tissue dysfunction (e.g., increased liver enzyme activity or pathologic changes in female genital epithelial cells), as well as physiologic signs of dysfunction such as increased blood pressure or decreased lung capacity. Note that these markers are not often substance specific. They also may not be directly adverse, but can indicate potential health impairment (e.g., DNA adducts). Biomarkers of effects caused by cadmium are discussed in Section 3.8.2.

A biomarker of susceptibility is an indicator of an inherent or acquired limitation of an organism's ability to respond to the challenge of exposure to a specific xenobiotic substance. It can be an intrinsic genetic or other characteristic or a preexisting disease that results in an increase in absorbed dose, a decrease in the biologically effective dose, or a target tissue response. If biomarkers of susceptibility exist, they are discussed in Section 3.10, Populations That Are Unusually Susceptible.

3.8.1 Biomarkers Used to Identify or Quantify Exposure to Cadmium

Cadmium levels in blood, urine, feces, liver, kidney, hair, and other tissues have been used as biological indicators of exposure to cadmium. A discussion of the utility and limitations of each for human biomonitoring is provided below.

Blood cadmium levels are principally indicative of recent exposure(s) to cadmium rather than whole-body burdens (Ghezzi et al. 1985; Järup et al. 1988; Lauwerys et al. 1994; Roels et al. 1989). The 50th

3. HEALTH EFFECTS

percentile of blood cadmium concentrations in adults living in the United States was 0.330 µg/L (CDC 2011). Environmental exposure can elevate blood cadmium concentration to above 10 µg/L (Kido et al. 1990a, 1990b; Shiwen et al. 1990). Workers occupationally exposed to cadmium by inhalation may have blood cadmium levels ranging up to 50 µg/L (Roels et al. 1981b).

Urine cadmium levels primarily reflect total body burden of cadmium, although urine levels do respond somewhat to recent exposure (Bernard and Lauwerys 1986). Use of a biokinetic model, such as the Nordberg-Kjellström model, allows estimation of cadmium dietary consumption or airborne cadmium levels from urinary cadmium levels; these models are described in greater detail in Section 3.4.5.3. When the critical level for renal damage has been reached, urinary cadmium levels rise sharply because of the release of intrarenal cadmium along with decreased renal reabsorption of cadmium (Lauwerys et al. 1994; Roels et al. 1981b). In the U.S. general population, the geometric mean urinary cadmium level in adults is 0.232 µg/L (or 0.247 µg/g creatinine) (CDC 2011). In populations with substantial environmental or occupational exposure, values can range up to 50 µg/g creatinine, (Falck et al. 1983; Roels et al. 1981b; Tohyama et al. 1988). In environmentally exposed individuals, Buchet et al. (1990) report that abnormal values of various biomarkers are found in 5% of the population with urinary excretion of cadmium above the 2–4 µg Cd/24 hour level (approximately 1–3 µg/g creatinine). Significant correlations between total cadmium exposure and urinary cadmium levels have been found in environmentally exposed populations (Kido et al. 2004; Kobayashi et al. 2005; Shimbo et al. 2000). Among environmentally exposed subjects, there was good agreement between urinary cadmium levels measured at different times, suggesting that a single determination would be an accrument measure (Ikeda et al. 2005a).

Fecal cadmium may be used as a direct indicator of daily dietary intake of cadmium because dietary cadmium is poorly absorbed in the gastrointestinal tract (Kjellström et al. 1978). In workers exposed by inhalation, fecal cadmium has been used to estimate the amount of inhaled cadmium transported to the gastrointestinal tract and the amount of dust ingested incidentally at work (Adamsson et al. 1979). Fecal cadmium primarily reflects recently ingested cadmium and, therefore, is not a good indicator of past cadmium exposure (Shaikh and Smith 1984).

Liver and kidney tissues preferentially accumulate cadmium, and concentrations of cadmium in liver and kidney may be measured using non-invasive techniques such as *in vivo* neutron activation analysis or in the kidney by X-ray fluorescence analysis (Christofferson et al. 1987; Scott and Chettle 1986); however, the limit of detection is near background levels (Nordberg 2010). Levels in both tissues increase with age and level of cadmium exposure, but kidney cadmium concentration tends to peak around age 50–60,

3. HEALTH EFFECTS

while liver cadmium concentration continues to rise. Typical values for a 60-year-old North American with average environmental cadmium exposure are 25–40 µg/g wet weight in kidney cortex and 1–3 µg/g wet weight in liver (Elinder 1985b). In workers exposed to cadmium by inhalation, values up to 300 µg/g wet weight in kidney and 100 µg/g wet weight in liver can be found (Christoffersson et al. 1987; Roels et al. 1981b). Because kidney cadmium content begins to decline after the onset of cadmium-induced renal dysfunction, liver cadmium may be a better indicator of cadmium exposure than kidney cadmium, and it has been suggested that kidney dysfunction is likely to appear at liver cadmium concentrations between 30 and 60 µg/g wet weight (Roels et al. 1981b). *In vivo* liver and kidney cadmium measurements involving neutron activation analysis or X-ray fluorescence require complex and costly equipment and may pose a radiation hazard (Shaikh and Smith 1984), and those involving biopsy specimens (Lindqvist et al. 1989) require a painful and invasive procedure. Therefore, these methods for *in vivo* analysis are better suited for monitoring of occupationally exposed workers than environmentally exposed populations (Scott and Chettle 1986). Among cadmium workers, significant correlations of kidney cadmium levels with urinary and blood cadmium levels and liver cadmium with urinary cadmium levels were found (Börjesson et al. 1997, 2001). Similar correlations (urinary cadmium with renal cadmium) in an autopsy study of subjects without occupational exposure to cadmium; a urinary cadmium level of 1.7 µg/g creatinine was equivalent to a renal cadmium level of 50 µg/g (Orlowski et al. 1998).

Hair levels of cadmium have been used as a measure of cadmium exposure, although the possibility of exogenous contamination has led to substantial controversy concerning the reliability of hair levels as a measure of absorbed dose (Frery et al. 1993; Huel et al. 1984; Lauwerys et al. 1994, Shaikh and Smith 1984; Wilhelm et al. 1990). Recent evidence has shown a correlation between cadmium levels in the hair of newborn infants and their mothers (Huel et al. 1984) and between cadmium levels in scalp and pubic hair (Wilhelm et al. 1990), indicating that among environmentally exposed populations, external contamination may not be significant for hair samples taken close to the scalp. Under occupational conditions, external contamination may be a more substantial problem (Shaikh and Smith 1984).

On the other hand, Frery et al. (1993) evaluated hair levels in a male population with a high expected exposure to tobacco smoke and in a population of pregnant woman and their newborns; they concluded that cadmium hair analysis was a reliable indicator for the subjects with the highest exposure, but was not sensitive enough to resolve differences for low level exposures. Newborn cadmium hair levels were a more sensitive indicator than mother's hair, but the research was not able to determine if this was attributable to physiological changes or the lower reliability of the mother's head hair. Exogenous contamination is not considered a problem for newborn hair. The authors state that the variability

3. HEALTH EFFECTS

introduced by exogenous contamination can be minimized by using the first 8 cm of hair from the scalp and by using careful washing techniques. There was also no significant difference between hair levels for passive or nonsmokers indicating that either the above mentioned precautions worked or that the passive smoke source of exposure was not significant.

Cadmium measurements have been made on a variety of other biological materials, including milk (Schulte-Lobbert and Bohn 1977; Sikorski et al. 1989), placenta (Kuhnert et al. 1982; Roels et al. 1978; Saaranen et al. 1989), nails (Takagi et al. 1988), teeth (Sharon 1988), and cataractous lenses (Racz and Erdohelyi 1988). Although in some cases it could be established that levels in these tissues were higher among smokers than nonsmokers, the significance of cadmium levels as a marker of recent or total cadmium exposure has not been established for any of these tissues.

Studies in cadmium workers suggest that metallothionein levels may also be a biomarker of cadmium exposure. Elevated levels of metallothionein gene expression were observed in peripheral blood lymphocytes in highly exposed workers. The level of metallothionein gene expression was significantly correlated with blood and urinary cadmium levels (Lu et al. 2001). Urinary metallothionein correlates with cadmium concentrations in liver, kidney, and urine (Shaikh and Smith 1984; Tohyama et al. 1981). Relatively strong correlations have been found between urinary metallothionein and urinary cadmium levels in exposed humans (Kawada et al. 1990), and a dose-related increase in urinary metallothionein was found in rats exposed to cadmium in drinking water for up to 2 years (Shaikh et al. 1989). Hochi et al. (1995) also found a significant relationship between cadmium intake and urinary metallothionein levels among residents consuming cadmium-contaminated rice.

3.8.2 Biomarkers Used to Characterize Effects Caused by Cadmium

Acute inhalation exposure to high levels of cadmium causes respiratory damage and may lead to death. No information was located on biomarkers of respiratory effects in humans, but based on animal experiments, activity of alkaline phosphatase in the surfactant fraction of BALF has been suggested as a sensitive marker of pulmonary damage following acute cadmium inhalation (Boudreau et al. 1989). Such a biomarker of effect is not specific to cadmium exposure and would be most relevant to occupational exposures.

Renal dysfunction, usually first manifested as impaired tubular reabsorption of filtered solutes, is generally considered the primary toxic effect of chronic cadmium exposure (see Section 3.2). Impaired

3. HEALTH EFFECTS

kidney function has been measured by increased levels of solutes (proteins, amino acids, uric acid, calcium, copper, phosphorous, etc.) in urine and/or serum. Excess urinary excretion of low-molecular-weight proteins and solutes is associated with decreased tubular reabsorption. Increased excretion of high-molecular-weight proteins or decreased serum clearance of creatinine reflect glomerular dysfunction, which is generally associated with progressive renal damage (Roels et al. 1989). A brief discussion of the utility and limitations of several measures of tubular damage as biomarkers of effects of cadmium exposure is provided below. These biomarkers are normally found in the urine and elevated levels are not specific for cadmium.

Urinary β 2-microglobulin, a low molecular weight protein, has been widely used as an indicator of tubular renal dysfunction (Arisawa et al. 1997; Piscator 1984; Roels et al. 1981a; Smith et al. 1980). However, tubular renal dysfunction can be caused by exposures and diseases other than cadmium, so β 2-microglobulin is not a specific marker of cadmium-induced effects (Shaikh and Smith 1984). Practical considerations in using urinary β 2-microglobulin as a marker of tubular renal dysfunction include the need to control the pH of samples to prevent the rapid degradation that occurs at pH values below 5.5 (Shaikh and Smith 1984), and the fact that urinary β 2-microglobulin excretion normally rises with age (Roels et al. 1989).

Urinary retinol-binding protein is also considered to be a sensitive indicator of decreased tubular reabsorption, but it also is not specific for cadmium-induced damage in the kidney (Shaikh and Smith 1984; Topping et al. 1986). Retinol-binding protein is more stable in urine than β 2-microglobulin (Bernard and Lauwerys 1981) and appears to be of approximately equal sensitivity and specificity for detecting tubular proteinuria in cadmium-exposed populations (Topping et al. 1986). Levels of both proteins fluctuate over time, so regular, repeated sampling may be necessary to establish abnormal levels (Ormos et al. 1985).

Human complex-forming glycoprotein (pHC, also referred to as α ₁-microglobulin) is another sensitive marker of tubular renal dysfunction (Moriguchi et al. 2004, 2005a; Pless-Mulloli et al. 1998; Tohyama et al. 1986). As with retinol binding protein, pHC is more stable in urine than β 2-microglobulin at room temperature and low urinary pH levels.

Urinary N-acetyl- β -D-glucosaminidase (NAG), a lysosomal enzyme present in high concentrations in the proximal tubule, has been shown to correlate with urinary cadmium levels in occupationally and environmentally exposed subjects (Jin et al. 1999; Kalahasthi et al. 2007) and has a better correlation with

3. HEALTH EFFECTS

urinary cadmium levels than does β 2-microglobulin at low cadmium exposure levels (urinary cadmium $<10 \mu\text{g/g}$ creatinine) (Chia et al. 1989; Kawada et al. 1990; Mueller et al. 1989). However, increased urinary NAG activity can result from effects other than nephrotoxicity (Bernard and Lauwerys 1989). Jin et al. (1999) suggest that measurement of the B isozyme (NAG-B), which is released into the urine following tubular cell breakdown, may be a sensitive measure of renal damage.

Other enzymes, proteins, and amino acids in urine have been suggested as biological markers of incipient renal or liver damage resulting from cadmium exposure. Markers found to be sensitive indicators in exposed humans include trehalase (Iwata et al. 1988), alanine aminopeptidase (Mueller et al. 1989), and calcium (Buchet et al. 1990). Changes in urinary alkaline phosphatase, γ -glutamyl transferase, urate, and phosphate tend to be significant only after other markers of renal damage are clearly elevated (Mason et al. 1988). Several other enzymatic markers of cadmium-induced renal damage have been suggested based on animal studies (Bomhard et al. 1984; Gatta et al. 1989; Girolami et al. 1989). Aminoaciduria has been found to be more sensitive than proteinuria for renal damage in animal studies (Nomiyama et al. 1975), but less sensitive in humans (Axelsson and Piscator 1966). Recent work by Prozialeck et al. (2007) suggest that kidney injury molecule 1 may be a sensitive marker for renal dysfunction. At present, not enough information is available to determine which, if any, of these parameters provide sensitive and specific indicators of cadmium-induced renal damage.

At the present time, there is no single biological indicator for cadmium toxicity that is entirely adequate when considered alone. Measurement of cadmium levels in various biological materials can provide an indication of recent or total cadmium exposure, but the probability of adverse effects cannot be reliably predicted except at high exposure levels. Measurement of a variety of markers of renal dysfunction can provide a sensitive measure of early kidney toxicity, but cannot establish whether cadmium exposure was the cause.

There is also considerable controversy as to whether the critical concentration of urinary cadmium is closer to 5 or 10 $\mu\text{g Cd/g}$ creatinine, corresponding to about 100 and 200 ppm in the kidney, respectively. Roels et al. (1993) correlated a number of markers with cadmium in blood and urine in a study population of workers occupationally exposed to cadmium from cadmium smelting operations. Three main groupings of thresholds were identified corresponding with different markers of effects: one around 2 $\mu\text{g Cd/g}$ creatinine mainly associated with biochemical alterations (increased urinary 6-keto-prostaglandin F_{1x} and urinary sialic acid), a second around 4 $\mu\text{g Cd/g}$ creatinine associated with increased excretion of high molecular weight proteins (possibly due to disruption of the glomerular membrane polyanionic

3. HEALTH EFFECTS

charge) and tubular antigens or enzymes (BBA, NAG), and a third around 10 µg Cd/g creatinine associated with increased excretion of low molecular weight proteins and other indicators. The 10 µg Cd/g creatinine level had previously been proposed as the biological threshold for cadmium-induced nephropathy. Whether the earlier changes are indicative of irreversible adverse renal effects remains an area of continued investigation.

To further evaluate the reversibility of proteinuria, Roels et al. (1997) studied the progression of cadmium-induced renal tubular dysfunction in cadmium workers according to the severity of the microproteinuria at the time the exposure was substantially decreased. A total of 32 cadmium male workers were divided into two groups on the basis of historical records of urinary cadmium concentration (CdU) covering the period until 1984. The workers with CdU values of >10 µg Cd/g creatinine were subdivided further on the basis of the urinary concentration of β₂-microglobulin (β₂-MG-U) measured during the first observation period (1980–1984). In each group, the tubular microproteinuria as reflected by β₂-MG-U and the concentration of retinol-binding protein in urine as well as the internal cadmium dose as reflected by the concentration of cadmium in blood and urine were compared between the first and second (1990–1992) observation periods. Increased microproteinuria was often diagnosed in cases with CdU values of >10 µg Cd/g creatinine. The progression of tubular renal function was found to depend on the extent of the body burden of cadmium (as reflected by CdU) and the severity of the initial microproteinuria at the time high cadmium exposure was reduced or ceased. When cadmium exposure was reduced and β₂-MG-U did not exceed the upper reference limit of 300 µg/g creatinine, the risk of developing tubular dysfunction at a later stage was likely to be low, even in cases with historical CdU values occasionally >10 but always <20 µg Cd/g creatinine. When the microproteinuria was mild (β₂-MG-U >300 and ≤1,500 µg/g creatinine) at the time exposure was reduced, and the historical CdU values had never exceeded 20 µg Cd/g creatinine, there was indication of a reversible tubulotoxic effect of cadmium. When severe microproteinuria (β₂-MG-U >1,500 µg/g creatinine) was diagnosed in combination with historical CdU values exceeding 20 µg Cd/g creatinine, Cd-induced tubular dysfunction was progressive in spite of reduction or cessation of cadmium exposure.

For more information on biomarkers for renal and hepatic effects of chemicals see Agency for Toxic Substances and Disease Registry *Subcommittee Report on Biological Indicators of Organ Damage* (Agency for Toxic Substances and Disease Registry 1990a). For information on biomarkers for neurological effects see OTA (1990).

3. HEALTH EFFECTS

3.9 INTERACTIONS WITH OTHER CHEMICALS

Cadmium toxicity can be influenced by a wide variety of other chemicals. In humans, dietary deficiencies of calcium, protein, and vitamin D are likely to account for increased susceptibility to bone effects following cadmium exposure (Kjellström 1986c). Iron deficiency has been shown to increase gastrointestinal absorption of cadmium in humans (Flanagan et al. 1978), while oral zinc supplementation has been demonstrated to decrease the oral absorption of cadmium. No other information was located concerning interaction of cadmium with other chemicals in humans.

In animals, a few interactions following inhalation exposure have been evaluated. In rats exposed to cadmium chloride by inhalation, simultaneous exposure to zinc oxide prevents fatalities (Oldiges and Glaser 1986) and lung cancer (Oldiges et al. 1989). Exposure to an atmosphere containing 80% oxygen aggravated pulmonary damage from cadmium chloride inhalation in mice (Martin and Witschi 1985).

The toxicity of oral exposure to cadmium in animals has been shown to be influenced by several factors. In Japanese quail, cadmium toxicity was intensified by single or combined deficiencies of zinc, copper, iron, calcium, and protein (Fox et al. 1979). A calcium-deficient diet in animals has been shown to aggravate cadmium immunotoxicity (Chopra et al. 1984) and fetotoxicity (Pond and Walker 1975). Simultaneous exposure to lindane increased the developmental toxicity of cadmium in rats (Saxena et al. 1986). Female rats have an increased susceptibility to cadmium-induced bone loss due to multiple rounds of gestation and lactation (Bhattacharyya et al. 1988b) or ovariectomy (Bhattacharyya et al. 1988c), possibly related to associated effects on trace element status. Hopf et al. (1990) report that exposure to ethanol and cadmium in a liquid diet produced liver damage in rats at doses that were not separately hepatotoxic. In contrast, Kershaw et al. (1990) reported that ethanol pretreatment in male Sprague-Dawley rats substantially reduced the lethal and hepatotoxic properties of cadmium, possibly due to a reduced interaction between cadmium and target sites in liver organelles and cytosolic high-molecular-weight (HMW) proteins. Ethanol pretreatment in this study decreased (approximately 60%) the content of cadmium in nuclei, mitochondria, and endoplasmic reticulum, and nearly eliminated the association of cadmium with cytosolic HMW proteins. Reduction in the concentration of cadmium in potential target sites of intoxication was caused by a metallothionein-promoted sequestration of cadmium to the cytosol.

When cadmium is co-administered with ethanol in rats, there is a pronounced increase in cadmium accumulation in various regions of the brain (e.g., the corpus striatum and cerebral cortex). The cadmium is not bound to metallothionein, and there is a marked increase in lipid peroxidation and inhibition of

3. HEALTH EFFECTS

membrane bound enzymes (Pal et al. 1993a, 1993b). Rats pretreated with acetaminophen are more sensitive to the renal toxicity of cadmium in water (Bernard et al. 1988a). Co-administration of lead and cadmium in the diet of rats had additive effects in reducing body weights, but neurologic toxicity was antagonized (Nation et al. 1990).

Numerous interactions have been demonstrated in animals using parenteral exposure, generally indicating that induction of metallothionein by pretreatment with zinc, selenium, or other metals, reduces toxicity of parenteral cadmium exposure (Gunn et al. 1968a, 1968b; Naruse and Hayashi 1989; Yamane et al. 1990). Zinc, calcium, or magnesium can prevent injection site, testicular, and prostatic cancers induced by subcutaneous or intramuscular injection of cadmium, but these interactions have been shown to be a complex phenomenon, dependent on dose, route, and target organ (Poirier et al. 1983; Waalkes et al. 1989). Mn(II) pretreatment reduces Cd(II)-induced lethality (Goering and Klaassen 1985). Cadmium has been noted to have an inhibitory effect on manganese uptake (Gruden and Matausic 1989). In addition, manganese appears to be capable of increasing the synthesis of the metal-binding protein metallothionein (Waalkes and Klaassen 1985). Data from a study by Goering and Klaassen (1985) suggest that manganese pretreatment increases the amount of Cd⁺² bound to metallothionein, thereby decreasing hepatotoxicity due to unbound Cd⁺². The significance of these observations to humans exposed to cadmium and manganese by the oral or inhalation routes is not clear.

Induction of hepatic metallothionein by cold stress reduced the acute toxicity of cadmium given by gavage to mice (Baer and Benson 1987). In addition to effects on metallothionein induction, substances may interact with cadmium by altering the competition among metal ions for enzyme or regulatory protein binding sites. For example, simultaneous administration of garlic (which is high in reduced sulfhydryl groups) decreases oral cadmium renal toxicity in rats (Cha 1987).

Coexposure to selenium reduced the clastogenic effect of cadmium on mouse bone marrow (Mukherjee et al. 1988b). Selenium deficiency enhances cadmium-induced cardiotoxicity possibly mediated via lipid peroxidation indicated by a significant reduction in the activities of the selenoenzyme, glutathione peroxidase. Selenium supplements in the diet prevented cadmium's cardiotoxic effect (Jamall and Smith 1985a). Selenium has also been shown to prevent testicular damage in rats (Kar et al. 1960; Omaye and Tappel 1975). In testes, selenium as selenite given before or during cadmium administration was shown to divert the binding of cadmium from low molecular proteins to higher molecular weight proteins (Chen et al. 1975; Whanger 1992). In contrast, Jamall and Smith (1985c) report a shift in cadmium binding from metallothionein to lower weight proteins in kidney and liver from a diet supplemented with

3. HEALTH EFFECTS

selenium compared to a selenium deficient diet. The selenium-cadmium interaction thus appears to be dependent on the duration and sequence of coexposure and possibly the organ-specific levels of selenoenzymes or other essential metals.

3.10 POPULATIONS THAT ARE UNUSUALLY SUSCEPTIBLE

A susceptible population will exhibit a different or enhanced response to cadmium than will most persons exposed to the same level of cadmium in the environment. Reasons may include genetic makeup, age, health and nutritional status, and exposure to other toxic substances (e.g., cigarette smoke). These parameters result in increased absorption, reduced detoxification or excretion of cadmium, or compromised function of organs affected by cadmium. Populations who are at greater risk due to their unusually high exposure to cadmium are discussed in Section 6.7, Populations with Potentially High Exposures.

Differences in individual sensitivity to cadmium have not been systematically studied, but based on what is known about cadmium toxicity, some inferences can be made. Populations with depleted stores of calcium, iron, or other dietary components due to multiple pregnancies and/or dietary deficiencies could be expected to have increased cadmium absorption from the gastrointestinal tract. Urinary cadmium levels have been shown to be correlated with iron status among pregnant women (Åkesson et al. 2002). However, a general population study of women living in Japan (Tsukahara et al. 2003) did not find significantly elevated levels of urinary cadmium, β 2-microglobulin, or pHC among women with anemia or iron deficiency, as compared to healthy women. Populations with kidney damage from causes unrelated to cadmium exposure, including diabetes, some drugs and chemicals, and the natural age-related decline in kidney function, could be expected to exhibit nephrotoxicity at lower cadmium exposures than those of normal healthy adults (Buchet et al. 1990). There is also some evidence to suggest that diabetics may be more susceptible to the toxicity of cadmium (Åkesson et al. 2005; Buchet et al. 1990; Haswell-Elkins et al. 2008). Elevated levels of metallothionein-antibody have been significantly associated with excretion of biomarkers of tubular dysfunction among cadmium workers (Chen et al. 2006a), but not with urinary or blood cadmium levels. In a study of diabetics, metallothionein-antibodies were significantly associated with urinary levels of β 2-microglobulin levels, which were indicative of cadmium toxicity but not with urinary albumin levels, which would be indicative of glomerular damage (Chen et al. 2006c). However, a significant association between elevated albumin creatinine ratio and urinary cadmium levels was found in another study of diabetics (Haswell-Elkins et al. 2008) and the frequency of albuminuria

3. HEALTH EFFECTS

was 64% among diabetics with high urinary cadmium levels of 1–2 µg/g creatinine and 80% among those with urinary cadmium levels of >2 µg/g creatinine.

A discussion of the susceptibility of children is found in Section 3.7, Children's Susceptibility.

3.11 METHODS FOR REDUCING TOXIC EFFECTS

This section will describe clinical practice and research concerning methods for reducing toxic effects of exposure to cadmium. However, because some of the treatments discussed may be experimental and unproven, this section should not be used as a guide for treatment of exposures to cadmium. When specific exposures have occurred, poison control centers and medical toxicologists should be consulted for medical advice. The following texts provide specific information about treatment following exposures to cadmium:

Caravati EM, McGuigan MA, MacGregor Whyte I, et al. Cadmium fume pneumonitis. In: Medical toxicology, 3rd ed. Philadelphia, PA: Lippincott Williams & Wilkins, 1411-1414.

Leikin JB, Paloucek FP. 2002. Cadmium. In: Poisoning and toxicology handbook. Hudson, OH: Lexi-Comp, Inc., 309-310.

Viccellio P. 1998. Cadmium, mercury, and arsenic. In: Emergency toxicology. 2nd ed. Philadelphia, PA: Lippincott-Raven Publishers, 379-380.

3.11.1 Reducing Peak Absorption Following Exposure

Inhalation exposure to high concentrations of cadmium can be particularly dangerous because initial symptoms are often as mild as those associated with low-level exposure, and exposed individuals who are unaware either of the presence of cadmium or of the dangers of inhaling cadmium may allow exposure to continue until a harmful or even fatal dose is received (Beton et al. 1966; Lucas et al. 1980). Severe respiratory symptoms that may develop within a few hours of high-dose inhalation exposure include tracheobronchitis, pneumonitis, and pulmonary edema, accompanied by additional nonspecific flu-like symptoms (sweating, shivering, malaise) (Beton et al. 1966). Aside from removing a victim to fresh air and providing supportive medical care, no effective means have been reported for reducing absorption following inhalation exposure to cadmium (Bronstein and Currance 1988; EPA 1989d). Supportive medical care of individuals with inhalation exposure to high levels of cadmium includes monitoring for respiratory distress, assisting ventilation as needed, and administering humidified oxygen (Bronstein and Currance 1988; EPA 1989d). If pulmonary edema develops, individuals may be treated with

3. HEALTH EFFECTS

supplemental oxygen, positive-pressure mechanical ventilation, and administration of diuretics, intravenous fluids, and steroid medications. Antibiotic therapy and monitoring fluid balance (due to kidney function impairment) may also be required (Beton et al. 1966; Bronstein and Currance 1988; EPA 1989d; Haddad and Winchester 1990).

Oral exposure to cadmium is not an immediate threat because high doses are irritating enough to induce vomiting. In fact, the only known acute fatalities from oral exposure to cadmium followed intentional ingestion of high doses (Baker and Hafner 1961; Buckler et al. 1986; Frant and Kleeman 1941; Nordberg et al. 1973; Shipman 1986; Wisniewska-Knypl et al. 1971). Although inducing vomiting is sometimes recommended following ingestion of cadmium (Ellenhorn and Barceloux 1988; Stutz and Janusz 1988), concentrated cadmium solutions may be caustic, and esophageal damage could result from spontaneous or induced vomiting. Administration of water or milk may be indicated for patients able to swallow (Bronstein and Currance 1988; EPA 1989d). Administration of cathartics such as sorbitol or magnesium sulfate to enhance elimination from the gastrointestinal tract has been recommended (EPA 1989d; Stutz and Janusz 1988); however, the administration of activated charcoal to bind unabsorbed cadmium does not appear to be effective (Agency for Toxic Substances and Disease Registry 1990b; Ellenhorn and Barceloux 1988).

The intestinal absorption of cadmium at levels below those leading to gastrointestinal damage is relatively low (5–10% of the administered dose) (Flanagan et al. 1978; McLellan et al. 1978; Newton et al. 1984; Rahola et al. 1973). Other polyvalent cations including calcium, magnesium, and zinc can interfere with cadmium uptake (Foulkes 1985), but administration of competing cations can in some cases increase rather than decrease cadmium absorption (Jaeger 1990), and is therefore not recommended for the treatment of cadmium ingestion. Oral administration of some compounds that chelate cadmium such as meso-2,3-dimercaptosuccinic acid has been found in rodent studies to reduce absorption following acute oral exposure to cadmium, but other chelators such as dithiocarbamates can increase toxicity (see Section 3.4.1.2). At present, no recommendations for chelation treatment to reduce absorption can be made (Jones and Cherian 1990). Administration of garlic (which is high in reduced sulfhydryl groups) has been shown to decrease oral cadmium toxicity in rats (Cha 1987). Thus, use of garlic could be an area of future research.

Dermal or ocular exposure to high levels of cadmium may cause irritation (Wahlberg 1977) and should be treated by removing contaminated clothing, washing the skin, and thoroughly flushing the eyes (EPA

3. HEALTH EFFECTS

1989d; Stutz and Janusz 1988). These measures will also reduce the relatively small potential for dermal absorption of cadmium (see Section 3.4.1.3).

3.11.2 Reducing Body Burden

A variety of chelating agents have been evaluated (Cantilena and Klaassen 1981; Jones et al. 1992, 1994; Kostial et al. 1996; Singh et al. 1996). Some of the more familiar chelators that are beneficial for other toxic metals actually increase cadmium toxicity by mobilizing the cadmium and substantially increasing the renal concentrations and toxicity (Agency for Toxic Substances and Disease Registry 1990b; Goldfrank et al. 1990; Jones and Cherian 1990). One such agent is the chelating agent dimercaprol (also known as BAL, British Anti-Lewisite), commonly used for treating cases of lewisite toxicosis. BAL is widely recognized as harmful in treating cadmium exposures. Some sources recommend using ethylenediamine tetraacetic acid (EDTA) salts (Cantilena and Klaassen 1980, 1981; Ellenhorn and Barceloux 1988; Stutz and Janusz 1988) or use of EDTA with caution about potential nephrotoxicity (EPA 1989d; Haddad and Winchester 1990). Other chelators that have reduced the cadmium burden in animal studies include diethylenetriaminepentaacetic acid (DTPA), 2,3-dimercaptosuccinic acid (DMSA), and various dithiocarbamates (Cantilena and Klaassen 1981, 1982b; Kamenosono et al. 2002a; Wang et al. 1999).

Cantilena and Klaassen (1982a) demonstrated the importance of rapid administration of DTPA, EDTA, or DMSA following acute cadmium exposure if they are to be effective. Waalkes et al. (1983) evaluated the role of metallothionein in the acute drop in chelator efficacy following cadmium poisoning in male Sprague-Dawley rats. Although the chelator, DTPA, reduced cadmium content in the various organs when given immediately after cadmium, it was ineffective at all later times. Increases in hepatic and renal metallothionein did not occur until 2 hours after cadmium, and did not coincide with the earlier drop in chelator efficacy. Blockade of metallothionein synthesis by actinomycin D treatment (1.25 mg/kg, 1 hour before Cd) failed to prolong the chelators effectiveness. Furthermore, newborn rats have high levels of hepatic metallothionein, which had no effect on the time course of chelator effectiveness since DTPA still decreased cadmium organ contents, if given immediately following cadmium, but had no effect if given 2 hours after cadmium. The authors concluded that metallothionein does not have an important role in the acute decrease in efficacy of chelation therapy for cadmium poisoning. The quick onset of chelator ineffectiveness may be due to the rapid uptake of cadmium into tissues, which makes it relatively unavailable for chelation.

3. HEALTH EFFECTS

Jones et al. (1992, 1994) investigated a series of monoalkyl and monoalkyl esters of meso-2,3-dimercaptosuccinic acid. Monoisoamyl meso-2,3-dimercaptosuccinate (Mi-ADMS) was an effective chelating agent for reduction of kidney and liver cadmium when administered either parenterally or orally (Jones et al. 1992). This finding was supported by a study by Eybl et al. (1994), which showed that Mi-ADMS, administered orally every 48 hours for 12 days after acute cadmium exposure, was effective at reducing cadmium in the kidney and liver, but not in the testes and brain. Monophenethyl meso-2,3-dimercaptosuccinic acid, mono(3-phenylpropyl) meso-2,3-dimercaptosuccinic acid, and mono(2-phenoxyethyl) meso-2,3-dimercaptosuccinic acid compounds successfully remove “aged” cadmium deposits and can be administered via a variety of routes (Jones et al. 1994).

Another area of chelation therapy research is in the use of multiple chelators. Blaha et al. (1995) evaluated the ability of two carbodithioate chelators, sodium N-(4-methylbenzyl)-4-O-(β -D-galactopyranosyl)-D-glucamine-N-carbodithioate (MeBLDTC) and sodium 4-carboxyamidopiperidine-N-carbothioate (INADTC), singly or in combination to reduce cadmium burden from chronically exposed rats. The combination therapy resulted in a synergistic effect on increased biliary excretion and reduced renal cadmium that, in the case of biliary excretion, was more than doubled that expected for a simple additive interaction.

3.11.3 Interfering with the Mechanism of Action for Toxic Effects

The toxic effects of cadmium are generally thought to be caused by “free” cadmium ions; that is, cadmium not bound to metallothionein or other proteins (Goyer et al. 1989). However, cadmium bound to metallothionein may have the capacity to directly damage renal tubular membranes during uptake (Suzuki and Cherian 1987). Free cadmium ions may have a number of adverse effects, including inactivation of metal-dependent enzymes, activation of calmodulin, and initiation of the production of active oxygen species (Palmer et al. 1986; Waalkes and Goering 1990).

Respiratory damage caused by acute, high-level inhalation exposure to cadmium can cause impaired lung function that can last many years after exposure (Barnhart and Rosenstock 1984; Townshend 1982). No treatments other than supportive care and avoidance of additional risk factors for lung injury are presently known.

The kidneys appear to be highly vulnerable to chronic cadmium exposure by either the oral or inhalation routes. The basis for the preferential sensitivity of the kidney is related to the filtering and reabsorption of

3. HEALTH EFFECTS

circulating cadmium-metallothionein complex, which is then thought to be degraded in the tubular cell lysosomes and released as free intracellular cadmium. The toxic effect results from the limited ability of the kidney to synthesize new cytosolic metallothionein in response to an increasing cadmium load (Goyer et al. 1989). Cadmium bound to metallothionein, however, may also have nephrotoxic activity (Suzuki and Cherian 1987).

No treatments are currently available that specifically target free cadmium ions in the renal cortex, but zinc and calcium can stimulate metallothionein synthesis and may also compete with cadmium for enzyme binding sites. Thus, zinc, and/or calcium supplementation might help reduce renal cadmium toxicity, at least in zinc- or calcium-deficient individuals. It is not known whether administration of these compounds would be beneficial in individuals with adequate zinc and calcium intakes, and their clinical use is not currently recommended. Since one of the postulated mechanisms of cadmium toxicity is the stimulation and production of active oxygen species, it is possible that increasing the cellular levels of antioxidants such as superoxide dismutase, reduced sulfur compounds (particularly glutathione), vitamin C, vitamin E, or β -carotene could reduce renal cadmium toxicity by scavenging active oxygen species prior to reaction with cellular components. Several animal studies have examined co-administration of several antioxidants on cadmium-induced kidney damage. Beneficial effects were found for vitamin E (Shaikh and Tang 1999; Shaikh et al. 1999a), N-acetyl cysteine (Kaplan et al. 2008; Shaikh et al. 1999a, 1999b), glycine (Shaikh and Tang 1999), glycyrrhizin (Nomiya and Nomiya 1998), and a drug containing glycyrrhizin, glycine, and cysteine (Shaikh and Tang 1999; Shaikh et al. 1999a). However, antioxidants are not currently recommended for the treatment of cadmium-exposed humans.

Treatments for the cadmium-related effects on bone have not been evaluated. Although the mechanism of bone damage has not been fully elucidated, it is likely that calcium loss and altered vitamin D metabolism, which result from cadmium-induced kidney damage, play an important role. Thus, treatments that interfere with the renal damage will likely have a beneficial effect on bone.

Research in chelation therapy is promising for agents that can interfere or possibly reverse the toxic effects of cadmium. Xu et al. (1995, 1996) demonstrated that monoisoamyl meso-2,3-dimercaptosuccinate, when administered within 1 hour after acute exposure, prevents the formation of cadmium-induced apoptotic DNA fragmentation and associated histopathological injury in the testes of rats. Perry et al. (1989) report a reversal of the cadmium induced hypertension in rats with the chelator d-myo-inositol-1,2,6-triphosphate.

3. HEALTH EFFECTS

3.12 ADEQUACY OF THE DATABASE

Section 104(I)(5) of CERCLA, as amended, directs the Administrator of ATSDR (in consultation with the Administrator of EPA and agencies and programs of the Public Health Service) to assess whether adequate information on the health effects of cadmium is available. Where adequate information is not available, ATSDR, in conjunction with the National Toxicology Program (NTP), is required to assure the initiation of a program of research designed to determine the health effects (and techniques for developing methods to determine such health effects) of cadmium.

The following categories of possible data needs have been identified by a joint team of scientists from ATSDR, NTP, and EPA. They are defined as substance-specific informational needs that if met would reduce the uncertainties of human health assessment. This definition should not be interpreted to mean that all data needs discussed in this section must be filled. In the future, the identified data needs will be evaluated and prioritized, and a substance-specific research agenda will be proposed.

3.12.1 Existing Information on Health Effects of Cadmium

The existing data on health effects of inhalation, oral, and dermal exposure of humans and animals to cadmium are summarized in [Figure 3-6](#). The purpose of this figure is to illustrate the existing information concerning the health effects of cadmium. Each dot in the figure indicates that one or more studies provide information associated with that particular effect. The dot does not necessarily imply anything about the quality of the study or studies, nor should missing information in this figure be interpreted as a “data need”. A data need, as defined in ATSDR’s *Decision Guide for Identifying Substance-Specific Data Needs Related to Toxicological Profiles* (Agency for Toxic Substances and Disease Registry 1989), is substance-specific information necessary to conduct comprehensive public health assessments. Generally, ATSDR defines a data gap more broadly as any substance-specific information missing from the scientific literature.

There is a massive database regarding the health effects of cadmium. In humans, the majority of studies have involved workers exposed by inhalation or residents of cadmium-polluted areas exposed primarily in the diet. Quantitative estimates of exposure levels are not available for many of these studies; however, many studies provided information on urinary cadmium levels that would be reflective of the cadmium body burden. Lethality, systemic toxicity, genotoxicity, and cancer have been studied in humans more

3. HEALTH EFFECTS

Figure 3-6. Existing Information on Health Effects of Cadmium

	Systemic									
	Death	Acute	Intermediate	Chronic	Immunologic/Lymphoretic	Neurologic	Reproductive	Developmental	Genotoxic	Cancer
Inhalation	●	●	●	●	●	●	●	●	●	●
Oral	●	●	●	●		●	●		●	●
Dermal		●			●					

Human

	Systemic									
	Death	Acute	Intermediate	Chronic	Immunologic/Lymphoretic	Neurologic	Reproductive	Developmental	Genotoxic	Cancer
Inhalation	●	●	●	●	●		●	●	●	●
Oral	●	●	●	●	●	●	●	●	●	●
Dermal	●				●					

Animal

● Existing Studies

3. HEALTH EFFECTS

extensively than immunotoxicity or neurotoxicity, with less being known about reproductive or developmental toxicity of cadmium in humans following inhalation or oral exposure. In animals, effects following oral exposures have generally been more thoroughly investigated than those following inhalation exposure, and few studies of cadmium toxicity following dermal exposure in humans were located.

3.12.2 Identification of Data Needs

Acute-Duration Exposure. There are limited data on the acute toxicity of cadmium in humans. Although there are numerous reports of respiratory effects in workers exposed to high concentrations of cadmium, there are no reliable estimates of levels associated with these effects. Animal studies provide support for identification of the respiratory tract as the most sensitive target of toxicity following inhalation exposure. Acute exposures to high levels of airborne cadmium has resulted in pneumonia, emphysema, and edema in laboratory animals (Boudreau et al. 1989; Buckley and Bassett 1987b; Bus et al. 1978; Grose et al. 1987; Hart 1986; Henderson et al. 1979; NTP 1995; Palmer et al. 1986) and lower concentrations were associated with focal inflammation and minimal fibrosis (NTP 1995). A decreased immune response in mice was observed at similar cadmium concentrations (Graham et al. 1978; Krzystyniak et al. 1987). Other adverse effects observed at higher concentrations include erosions of the stomach, decreases in body weight, and reduced activity (Rusch et al. 1986). The available acute-duration animal data were considered adequate for derivation of an acute-duration inhalation MRL for cadmium.

There are no reliable human studies on the toxicity of cadmium following acute-duration oral exposure. In laboratory animals, acute exposure to high doses of cadmium resulted in a variety of effects, including altered hematological parameters, focal necrosis and degeneration of the liver, focal necrosis in renal tubular epithelium, necrosis and ulceration in the stomach and intestines, decreased motor activity, and testicular atrophy and necrosis (Andersen et al. 1988; Basinger et al. 1988; Bomhard et al. 1987; Borzelleca et al. 1989; Dixon et al. 1976; Kotsonis and Klaassen 1977; Machemer and Lorke 1981; Sakata et al. 1988; Shimizu and Morita 1990). There is some indication that developmental effects (delays in ossification and increased malformations) may occur at lower cadmium doses (Baranski 1985; Machemer and Lorke 1981). The acute-duration oral database was not considered adequate for derivation of an MRL because the results of the study that identified the lowest LOAEL (Baranski 1985) were inadequately reported and were inconsistent with a longer-duration study conducted by the same investigator. Although the data suggest that the developing organism is the most sensitive target,

3. HEALTH EFFECTS

additional studies are needed to support this assumption. Studies characterizing the dose-response relationships for the most sensitive effects are needed for derivation of an acute-duration oral MRL.

No reliable information was located regarding toxicity following dermal exposure to cadmium, but based on the lack of reported effects in the workers handling cadmium compounds, it seems unlikely that dermal exposure could deliver a significant dose of cadmium.

Intermediate-Duration Exposure. There are limited data on the toxicity of cadmium in humans following intermediate-duration exposure.

Intermediate-duration inhalation studies in laboratory animals have identified several targets of toxicity including the respiratory tract (Glaser et al. 1986; Kutzman et al. 1986; NTP 1995; Prigge 1978a), reproductive effects (Baranski and Sitarek 1987; NTP 1995), and developing nervous system (Baranski 1984, 1985). At the lowest cadmium concentration tested, alveolar histiocytic infiltration and degeneration or metaplasia in the larynx were observed in mice (NTP 1995) and neurodevelopmental effects were observed in rats (Baranski 1984, 1985). These LOAELs were considered for derivation of an intermediate-duration inhalation MRL; however, an MRL based on the human equivalent concentration of the LOAELs would be lower than the chronic-duration inhalation MRL based on human data. Additional studies are needed to identify no-adverse-effect levels in animals for these sensitive targets of toxicity.

A number of studies have been conducted involving intermediate-duration oral exposure to laboratory animals. The results of these studies suggest that the growing bone is the most sensitive target. The skeletal effects observed in young rats include decreases in bone mineral density, impaired mechanical strength, increased fractures, and increased bone turnover (Brzóška and Moniuszko-Jakoniuk 2005a, 2005b, 2005d; Brzóška et al. 2004b, 2005a, 2005b, 2005c; Ogoshi et al. 1989). Developmental effects, including impaired renal function and neurodevelopmental alterations, have been observed at similar dose levels (Ali et al. 1986; Baranski et al. 1983; Jacquillet et al. 2007). At higher doses, observed effects included renal damage (proteinuria, tubular necrosis, and decreased renal clearance), liver necrosis, and anemia (Cha 1987; Gatta et al. 1989; Groten et al. 1990; Itokawa et al. 1974; Kawamura et al. 1978; Kawamura et al. 1978; Kotsonis and Klaassen 1978; Prigge 1978a), altered immune response (Blakley 1985, 1986; Chopra et al. 1984), decreased motor activity (Kotsonis and Klaassen 1978; Nation et al. 1990), and necrosis and atrophy of seminiferous tubules and decreased sperm count and motility (Cha

3. HEALTH EFFECTS

1987; Saxena et al. 1989). The database of intermediate-duration animal studies was considered adequate for derivation an intermediate-duration oral MRL based on skeletal effects in growing rats.

No intermediate-duration dermal data were identified in humans or animals. Studies of possible toxicity in animals following intermediate-duration dermal exposure to cadmium are needed to evaluate potential health effects in humans exposed to cadmium primarily by the dermal route.

Chronic-Duration Exposure and Cancer. Data on the chronic toxicity of inhaled cadmium in humans come from numerous occupational exposure studies; no reliable animal studies examining noncancerous end points were identified. These studies have identified the respiratory tract (emphysema, impaired lung function) (Chan et al. 1988; Cortona et al. 1992; Davison et al. 1988; Smith et al. 1976) and the kidney (tubular proteinuria, decreased glomerular filtration rate, increased excretion of low molecular weight proteins) (Bernard et al. 1990; Chen et al. 2006a, 2006b; Chia et al. 1992; Elinder et al. 1985a; Falck et al. 1983; Jakubowski et al. 1987, 1992; Järup and Elinder 1994; Järup et al. 1988; Shaikh et al. 1987; Toffoletto et al. 1992; Verschoor et al. 1987) as the most sensitive targets of toxicity. Comparisons of the adverse effect levels for these two end points are difficult because the studies on respiratory effects typically reported air concentrations (current levels or estimated cumulative exposure) as the exposure biomarker and those examining renal effects typically used urinary cadmium levels as the exposure biomarker; based on limited data, the kidney appears to be the more sensitive target. Studies examining both end points in occupationally exposed populations would provide valuable information on sensitivity. None of the available human studies were considered adequate for derivation of an inhalation MRL because cadmium air concentrations were poorly characterized or no data were provided on the contribution of dietary cadmium to the cadmium body burden. However, the similarities on the toxicity and toxicokinetics of cadmium following inhalation and oral exposure allow for the use of the oral database to derive an inhalation MRL.

There is an extensive database of studies examining the chronic oral toxicity of cadmium in humans. These environmental exposure studies have identified two sensitive targets of cadmium toxicity—the skeletal system and the kidney. The skeletal effects included increased risk of osteoporosis and bone fractures and decreases in bone mineral density (Alfvén et al. 2000, 2004; Nordberg et al. 2002; Schutte et al. 2008; Staessen et al. 1999; Wang et al. 2003). Renal effects range from death due to renal failure (Arisawa et al. 2001, 2007b; Iwata et al. 1991a, 1991b; Matsuda et al. 2002; Nakagawa et al. 1993; Nishijo et al. 1995, 2004a, 2006) to increases in the prevalence of low molecular weight proteinuria (Buchet et al. 1990; Cai et al. 1990, 1992, 1998, 2001; Hayano et al. 1996; Ishizaki et al. 1989; Izuno et

3. HEALTH EFFECTS

al. 2000; Järup et al. 2000; Jin et al. 2002, 2004a, 2004c; Kawada et al. 1992; Kido and Nogawa 1993; Kobayashi et al. 2002a; Monzawa et al. 1998; Nakashima et al. 1997; Nogawa et al. 1989; Noonan et al. 2002; Nordberg et al. 1997; Olsson et al. 2002; Oo et al. 2000; Osawa et al. 2001; Roels et al. 1981b; Suwazono et al. 2006; Teeyakasem et al. 2007; Trzcinka-Ochocka et al. 2004; Uno et al. 2005; Yamanaka et al. 1998; Wu et al. 2001). Animal studies confirm the identification of the kidney and bone as the most sensitive targets of cadmium toxicity (Akahori et al. 1994; Bernard et al. 1992; Bomhard et al. 1984; Brzóska and Moniuszko-Jakoniuk 2004a, 2004b; Fingerle et al. 1982; Mangler et al. 1988). Sufficient information from human studies is available to derive a chronic oral MRL. No information was located regarding dermal toxicity of chronic cadmium exposure in humans or animals, and studies of dermal toxicity are needed to evaluate risks to populations exposed to cadmium primarily by dermal contact.

The evidence of carcinogenicity from human studies is limited, due to uncertainties in cadmium exposure estimates and confounding factors including exposure to arsenic, a known human lung carcinogen, and smoking. Occupational exposure studies have found significant increases in lung cancer mortalities (Ades and Kazantzis 1988; Järup et al. 1998a; Kazantzis et al. 1988; Stayner et al. 1992a; Sorahan 1987; Sorahan and Waterhouse 1983; Thun et al. 1985). However, lung cancer deaths were often not significantly associated with cadmium exposure or duration. Other studies have not found increases in lung cancer deaths (Armstrong and Kazantzis 1983; Elinder et al. 1985c; Lamm et al. 1992, 1994; Sorahan and Esmen 2004; Sorahan and Lancashire 1997). Additional occupational exposure studies controlling for these exposures and providing more precise cadmium dose estimates are needed to provide more definitive evidence of the carcinogenic potential in humans of inhaled cadmium. Evidence for the carcinogenicity of cadmium by the inhalation route is available from studies in rats (Takenaka et al. 1983). Additional studies in animals are needed to evaluate the lack of an observed increase in lung cancer in mice and hamsters exposed to cadmium by inhalation (Heinrich et al. 1989). Cadmium has not been shown to be carcinogenic following oral exposure in humans (Bako et al. 1982; Hardell et al. 1994; Inskip et al. 1982; Lauwerys and De Wals 1981; Nakagawa et al. 1987; Shigematsu 1984). In rats, however, cadmium increased tumors of the prostate, testes, and hematopoietic system (Waalkes et al. 1992). Additional lifetime-exposure studies in rats, mice, and hamsters orally exposed to cadmium at sufficiently high doses are needed to further define the carcinogenic potential of cadmium.

Genotoxicity. The evidence for the genotoxicity of cadmium is mixed (see [Tables 3-10](#) and [3-11](#)). *In vitro* studies have provided both positive and negative results (Amacher and Paillet 1980; Bruce and Heddle 1979; Casto et al. 1979; Denizeau and Marion 1989; Depault et al. 2006; Fatur et al. 2002; Filipic and Hei 2004; Honma et al. 1999; Jianhua et al. 2006; Lopez-Ortal et al. 1999; Lutzen et al. 2004; Lynn et

3. HEALTH EFFECTS

al. 1997; Mikhailova et al. 1997; Oberly et al. 1982; Rozgaj et al. 2002; Shiraishi et al. 1972; Terracio and Nachtigal 1988). Studies of chromosomal aberrations in humans (Bui et al. 1975; Deknudt and Leonard 1975; Fu et al. 1999; O'Riordan et al. 1978; Tang et al. 1990) and animals (Bruce and Heddle 1979; Desi et al. 2000; DiPaulo and Castro 1979; Fahmy and Aly 2000; Karmakar et al. 1998; Mukherjee et al. 1988a; Tan et al. 1990; Watanabe et al. 1979) exposed to cadmium have also found both positive and negative results. DNA damage has been consistently observed in *in vitro* studies (Devi et al. 2001; Fahmy and Aly 2000; Kasuba et al. 2002; Mukherjee et al. 1988a; Saplakoglu et al. 1997; Valverde et al. 2000; Wronska-Nofer et al. 1999; Zhou et al. 2004b). In animals, parenteral, but not inhalation or oral, cadmium exposure has been found to cause germ cell mutations (Gillivod and Leonard 1975; Suter 1975; Sutou et al. 1980; Watanabe and Endo 1982; Zenick et al. 1982). Additional studies investigating effects in exposed humans using larger populations with quantitative estimates of exposure would be useful to evaluate the human genotoxicity of cadmium.

Reproductive Toxicity. Only limited or conflicting evidence is available to evaluate the potential for cadmium exposure to cause reproductive toxicity in humans. Some studies report no effect on male fertility (Gennart et al. 1992), sex hormone levels (Mason 1990; Menke et al. 2008; Zeng et al. 2004a), sperm density (Noack-Fuller et al. 1993), or semen quality (Jurasović et al. 2004; Saaranen et al. 1989), while others report a reduction in sperm number or viability (Akinloye et al. 2006; Telišman et al. 2000; Xu et al. 1993a) or alterations in sex steroid hormone levels (Akinloye et al. 2006; Jurasović et al. 2004; Telišman et al. 2000). In one study, men occupationally exposed to cadmium at levels resulting in renal damage had no change in testicular function (Mason 1990). Adverse effects in animals from inhalation exposure have been reported including increased duration of the estrous cycle (Baranski and Sitarek 1987; NTP 1995; Tsvetkova 1970), and increased relative testes weight but no loss in reproductive success (Kutzman et al. 1986). Adverse reproductive effects in animals from high-dose, acute, oral cadmium exposure have been reported including testicular atrophy and necrosis (Andersen et al. 1988; Bomhard et al. 1987; Borzelleca et al. 1989), and decreased fertility (Kotsonis and Klaassen 1978; Macheimer and Lorke 1981). At lower doses and intermediate exposures, adverse effects have included necrosis and atrophy of seminiferous tubule epithelium (Cha 1987), increased testes weight (Pleasant et al. 1992, 1993), increased prostatic hyperplasias (Waalkes and Rehm 1992), significantly increased relative testes weight, decreased sperm count and motility, decreased seminiferous tubular diameter, seminiferous tubular damage (Saxena et al. 1989), and decreased fertility (Sutou et al. 1980). Other animal studies for lower dose intermediate exposures, however, report no adverse effects (Baranski et al. 1983; Bomhard et al. 1987; Groten et al. 1990; Kostial et al. 1993; Kotsonis and Klaassen 1978; Loeser and Lorke 1977a; Pleasants et al. 1992; Pond and Walker 1975; Zenick et al. 1982). Additional studies in animals, as well

3. HEALTH EFFECTS

as retrospective, case-matched studies of reproductive success of populations for which occupational or environmental exposure to cadmium has been estimated, are needed to further evaluate the potential reproductive toxicity of cadmium in humans. Additional studies would be useful (preferably with larger sample sizes) to evaluate the robustness of the association between cadmium and adverse effects on sperm.

Developmental Toxicity. The potential for cadmium exposure to cause developmental toxicity from pre- or postnatal exposures in humans is not known. One study in occupationally exposed women reported children with lowered birth weights, but with no increase in malformations (Tsvetkova 1970). However, no control was made for parity, maternal weight, gestational age, or other factors known to influence birth weight. Many animal studies demonstrate that developmental toxicity may occur following cadmium exposure by oral routes with a relatively few studies reporting developmental effects following inhalation or oral exposure (Ali et al. 1986; Baranski 1985, 1987; Baranski et al. 1983; Gupta et al. 1993; Kelman et al. 1978; Kostial et al. 1993; Macheimer and Lorke 1981; Petering et al. 1979; Pond and Walker 1975; Schroeder and Mitchener 1971; Sorell and Graziano 1990; Sutou et al. 1980; Webster 1978; Whelton et al. 1988). At lower inhalation and oral doses, impaired performance on neurobehavioral tests have been observed (Ali et al. 1986; Baranski et al. 1983; Desi et al. 1998; Nagymajtenyi et al. 1997). Retrospective, case-matched studies of developmental toxicity among children of women with known occupational or environmental exposure to cadmium are needed to evaluate the potential for cadmium exposure to cause human developmental toxicity such as skeletal malformations and neurobehavioral effects (as suggested in animal studies). Studies are also needed to follow up on the results of increased susceptibility of young to bone damage (Ogoshi et al. 1989) or suppression of the immune response (Blakley 1985) reported in animals. The difference in the immune response (using the same protocol) between young mice (Blakley 1985) and older mice (Blakley 1988) should also be further evaluated. Studies of postnatal cadmium exposure to children, especially for children with diets deficient in calcium, protein, or iron, would be useful to evaluate whether increased cadmium absorption from the diet leads to developmental effects.

Immunotoxicity. A variety of immunologic effects have been found in animals exposed to cadmium by the oral or inhalation routes (Blakley 1988; Bouley et al. 1984; Cifone et al. 1989a). However, the biological significance of these effects is not clear, and there is little information available on immunotoxicity in humans. Investigations of immunologic function of populations occupationally or environmentally exposed to cadmium, and follow-up mechanistic studies in animals are needed to evaluate the potential immunotoxicity of cadmium exposure in humans.

3. HEALTH EFFECTS

Neurotoxicity. A few studies have suggested an association between cadmium exposure in humans and impaired neuropsychologic functioning at levels below those causing nephrotoxicity (Hart et al. 1989b; Marlowe et al. 1985; Thatcher et al. 1982). Neurotoxicity has also been found in animal studies (Nation et al. 1984; Wong and Klaassen 1982). Additional studies to investigate neurologic effects in populations with known cadmium exposure and studies of possible mechanisms of neurotoxicity in animals are needed to evaluate the potential neurotoxicity of cadmium exposure to humans. In addition, studies examining neurobehavioral end points in children would be useful.

Epidemiological and Human Dosimetry Studies. Cause/effect relationships for renal toxicity of cadmium have been derived from studies of workers occupationally exposed to cadmium by inhalation (Bernard et al. 1990; Chen et al. 2006a, 2006b; Chia et al. 1992; Elinder et al. 1985b; Falck et al. 1983; Jakubowski et al. 1987, 1992; Järup and Elinder 1994; Järup et al. 1988; Kawada et al. 1989; Roels et al. 1993; Shaikh et al. 1987; Thun et al. 1989; Toffoletto et al. 1992; Verschoor et al. 1987) and of populations environmentally exposed to cadmium in the diet (Buchet et al. 1990; Cai et al. 1990, 1992, 1998, 2001; Hayano et al. 1996; Ishizaki et al. 1989; Izuno et al. 2000; Järup et al. 2000; Jin et al. 2002, 2004a, 2004c; Kawada et al. 1992; Kido and Nogawa 1993; Kobayashi et al. 2002b; Monzawa et al. 1998; Nakadaira and Nishi 2003; Nakashima et al. 1997; Nogawa et al. 1989; Noonan et al. 2002; Nordberg et al. 1997; Roels et al. 1981a; Olsson et al. 2002; Oo et al. 2000; Osawa et al. 2001; Suwazono et al. 2000; Teeyakasem et al. 2007; Trzcinka-Ochocka et al. 2004; Uno et al. 2005; Watanabe et al. 2002; Wu et al. 2001; Yamanaka et al. 1998). There is also epidemiological evidence that chronic environmental exposure to cadmium can result in decreases in bone mineral density and increases in the risk of bone fractures and osteoporosis (Åkesson et al. 2005; Alfvén et al. 2000, 2004; Schutte et al. 2008; Staessen et al. 1999). Additional studies are needed to elucidate the mechanisms of these bone effects in humans and to determine if the skeletal system is a more sensitive target of cadmium toxicity than the kidney effects. Measurement of additional toxicity end points (reproductive, developmental, immunological, and neurological) in these well characterized populations are needed to evaluate whether any of these effects may occur at exposure levels below those leading to kidney damage. Additional development of PBPK/PD models is needed to evaluate human exposure scenarios. In its assessment of the U.S. population's exposure to environmental chemicals, the CDC measured urinary cadmium levels. If urinary cadmium levels are monitored in future assessments, it would be useful to also measure biomarkers of tubular dysfunction; these data would be useful in examining possible relationships between cadmium exposure and renal function in the general population.

3. HEALTH EFFECTS

Biomarkers of Exposure and Effect.

Exposure. Cadmium levels can be measured in a variety of tissues and fluids, including blood, urine, milk, liver, kidney, hair, and nails (Elinder and Lind 1985; Roels et al. 1981b; Sharma et al. 1982). Blood cadmium is a useful indicator of recent cadmium exposure, and urinary cadmium is a useful indicator of total body burden (Shaikh and Smith 1984). The most important indicator of the potential for toxicological injury is generally considered to be the cadmium concentration in the renal cortex, but individuals vary in the concentration causing renal effects (the "critical concentration") (Roels et al. 1981b). Methods for *in vivo* measurement of cadmium content in the kidney exist, but they are complex and expensive, and involve some exposure to ionizing radiation (Scott and Chettle 1986). Efforts to develop easier, safer, and less costly methods for *in vivo* analysis are needed, as well as studies to determine factors influencing individual variation in critical concentrations. Although many studies correct urinary cadmium levels for creatinine concentration, several investigators (Alessio et al. 1985; Ikeda et al. 2003a; Moriguchi et al. 2005b) have questioned the validity of this approach due to wide intra- and interindividual variability and age-related decline in levels. Additional studies are needed to further investigate methods to account for dilution in urine spot samples.

Effect. A number of sensitive tests are available to detect early stages of renal dysfunction that are known to be caused by cadmium exposure. These include analysis of urinary excretion of β 2-microglobulin, retinol-binding protein, metallothionein, or enzymes (Shaikh and Smith 1984). However, renal damage detected by these tests is not necessarily associated with cadmium exposure. Additional studies are needed to evaluate current or potentially new urinary or serum biomarkers in cadmium-exposed populations and their association with incipient injury to the kidney caused by cadmium. The bone is a sensitive target of cadmium toxicity, particularly during growth and in the elderly; studies are needed to develop sensitive biomarkers to detect early signs of bone damage.

Absorption, Distribution, Metabolism, and Excretion. Good information exists on cadmium toxicokinetics in humans and animals. PBPK/PD models have been developed to predict the critical organ dose as a function of route, duration, and level of exposure by the inhalation and oral routes (Kjellström and Nordberg 1978, 1985). Although general factors influencing absorption, distribution, metabolism, and excretion are known, additional studies are needed to provide information on metal metabolism and interactions that support quantitative evaluation of individual variations and resulting differences in renal cadmium accumulation. Very limited information exists on the dermal absorption of

3. HEALTH EFFECTS

cadmium (Skog and Wahlberg 1964; Wester et al. 1992). Additional studies on the dermal absorption of cadmium are needed.

Comparative Toxicokinetics. Animal and human studies have generally reported comparable toxicokinetics of cadmium (Kjellström and Nordberg 1985; Nordberg et al. 1985), suggesting that rats, mice, and rabbits are suitable models for cadmium toxicity in humans. However, some concerns have been raised about the appropriateness of the rat model for cadmium-induced lung tumors in humans because of differences in the morphology of the rat respiratory tract and resulting differences in cadmium particle deposition patterns and target cell populations. This is especially of concern because cadmium appears to be a contact carcinogen for lung cancer. Additional studies on the differences between the rat and human clearance rates, speciation at the level of the target cell, and protein transporters (as they relate to solubility and susceptibility) are needed to evaluate the appropriateness of the rat model for predicting cadmium-induced human lung cancers. Additional studies on differences in species, strain, sex, age, and other factors on cadmium kinetics and carcinogenic or other systemic effects are also needed to extrapolate the animal data to potential human toxicity. Additional studies establishing the toxicokinetics of cadmium in pregnant animals are needed to assess the relevance of the developmental effects observed in animals.

Methods for Reducing Toxic Effects. The mechanisms of cadmium absorption across epithelial layers are likely to be via nonspecific mechanisms (Foulkes 1989). No methods are known for influencing absorption across the lung, but absorption across the gastrointestinal tract may be influenced by dietary status (Flanagan et al. 1978). Studies to determine whether dietary adjustments might help decrease cadmium uptake from food or water are needed. Studies to determine the effects of dietary deficiencies in calcium are needed to further evaluate the risk of cadmium exposure to susceptible populations. Uptake across the skin is probably sufficiently slow that simple washing of exposed areas is adequate to prevent excessive absorption (Skog and Wahlberg 1964).

Once cadmium is absorbed, it tends to accumulate in the kidney, which is the main target tissue for chronic low-dose exposure. The cellular and molecular basis for the preferential accumulation in the kidney is only partially understood (Waalkes and Goering 1990), and additional studies to define the rate-limiting steps in renal uptake and renal clearance of cadmium are needed to design strategies for reducing the rate of cadmium accumulation in this tissue. Additional studies on existing and new chelating agents and different treatment regimens are needed to improve the clinical therapies for acute and chronic exposures to cadmium.

3. HEALTH EFFECTS

The mechanism of cadmium toxicity in renal cells and other tissues probably involves binding of free cadmium ions to key cellular enzymes and proteins (Waalkes and Goering 1990). Thus, any agent that prevents cadmium from binding might help prevent toxicity. The endogenous cadmium-binding protein can serve this function; however, metallothionein-cadmium complexes may have renal toxicity (Suzuki and Cherian 1987). Additional studies on the role of metallothionein in cadmium toxicity would be useful. Additional studies are needed on alternative substrate molecules or drugs that could interact with free cadmium and prevent binding to key cellular enzymes, as well as the ability of antioxidants to reduce damage from active-oxygen species produced by cadmium in tissues.

The impaired renal function that is the typical adverse effect of excessive cadmium exposure is neither clinically treatable nor reversible (Agency for Toxic Substances and Disease Registry 1990b; Roels et al. 1989). Studies on potential supportive treatment or remedies for cadmium-induced mild renal impairment would be valuable.

The bone is also a sensitive target of cadmium toxicity; however, methods for the treatment of the observed effects, decreased bone mineral density and increased fractures, have not been developed and are needed.

Children's Susceptibility. Data needs relating to both prenatal and childhood exposures, and developmental effects expressed either prenatally or during childhood, are discussed in detail in the Developmental Toxicity subsection above.

There is limited information on the toxicity of cadmium in children. Although it is likely that children will have similar effects as adults, there is some suggestive evidence that childhood exposure may result in increased renal toxicity, as compared to persons only exposed as adults (Trzcinka-Ochocka et al. 2004). Additionally, studies in animals suggest that young animals are more susceptible to cadmium-induced bone damage than adults (Ogoshi et al. 1989); this has not been investigated in humans. Studies are needed to evaluate whether there are age-specific differences in the toxicity of cadmium in humans. As discussed in the Developmental Toxicity section above, there are limited data on the developmental toxicity of cadmium in humans, particularly potential neurodevelopmental effects and additional studies are needed.

3. HEALTH EFFECTS

Additional research is needed on the toxicokinetics of cadmium during long-term, low-level exposures to determine the potential long-term tissue burdens that are likely to result especially for the susceptible tissues of liver, kidney, and bone. Data in animals suggest that children may absorb more cadmium than adults, but there are no human data examining these potential differences in the toxicokinetic properties of cadmium. Additional information is needed on cadmium transport across the blood-brain barrier in the developing fetus, and the role of metallothionein in the placenta.

Neurological and behavioral studies are needed that use the more sophisticated measures available today to evaluate children for *in utero*, acute, and longer term exposures. These studies should have the appropriate controls for confounding factors such as lead, parental use of ethanol, and living conditions.

Additional studies are needed to evaluate whether or not biomarkers of cadmium exposure and effects that have been developed for adults are also applicable to children. If not, new biomarkers of exposure and effect need to be developed.

The effects of nutritional status (iron, zinc, and calcium levels) on cadmium absorption and accumulation in children need further evaluation. Improved regimens and choices for chelation therapy are also needed.

Child health data needs relating to exposure are discussed in Section 6.8.1, Identification of Data Needs: Exposures of Children.

3.12.3 Ongoing Studies

A number of research projects are in progress investigating the health effects of cadmium. These projects are summarized in [Table 3-14](#).

3. HEALTH EFFECTS

Table 3-14. Ongoing Studies on Cadmium

Investigator	Study topic	Institution	Sponsor
Fadrowski, J	Determination if environmental cadmium exposure is associated with chronic kidney disease in children	John Hopkins University	National Institute of Environmental Health Sciences
Nebert, DW	Identify and characterize genes responsible for interindividual differences in the response to cadmium	University of Cincinnati	National Institute of Environmental Health Sciences
Thomas, DG and Kennedy, TS	Examination of the possible association between cadmium levels in maternal blood and breast milk and cognitive development in infants	Oklahoma State University	National Research Initiative
Newcomb, PA	Examination of the possible association between cadmium exposure and risk of breast cancer	Fred Hutchinson Cancer Research Center	National Institute of Environmental Health Sciences
Louie, MC	Examination of the contribution of cadmium to the progression of breast cancer	Dominican University of California	National Cancer Institute
Meliker, JR	Examination of possible association between cadmium exposure and breast cancer risk	State University of New York, Stony Brook	National Institute of Environmental Health Sciences
Rull, RP	Examination of possible association between cadmium exposure and endometrial cancer risk	Northern California Cancer	National Institute of Environmental Health Sciences
El Mauayed, M	Examination of the possible association between cadmium exposure and diabetes risk in carriers of a genetic variation of the zinc transporter ZnT8	Northwestern University	National Institute of Environmental Health Sciences
Guallar, EO	Possible association between cadmium exposure and cardiovascular risk in children	Johns Hopkins University	National Institute of Environmental Health Sciences
Heggland, SJ	Mechanisms of cadmium-induced osteotoxicity	Albertson College of Idaho	National Institute of Environmental Health Sciences

Source: FEDRIP 2012

3. HEALTH EFFECTS

This page is intentionally blank.

4. CHEMICAL AND PHYSICAL INFORMATION

4.1 CHEMICAL IDENTITY

[Table 4-1](#) lists the common synonyms, trade names, and other pertinent identification information for cadmium and its most important compounds.

4.2 PHYSICAL AND CHEMICAL PROPERTIES

[Table 4-2](#) lists important physical and chemical properties of cadmium and its most important compounds.

4. CHEMICAL AND PHYSICAL INFORMATION

Table 4-1. Chemical Identity of Cadmium and Compounds^a

Characteristic	Information		
Chemical name	Cadmium	Cadmium carbonate	Cadmium chloride
Synonym(s)	Colloidal cadmium	Otavite ^b ; cadmium monocarbonate; carbonic acid; cadmium salt	Caddy ^b ; Vi-Cad ^b ; cadmium dichloride; dichlorocadmium
Registered trade name(s)	No data	No data	No data
Chemical formula	Cd ^b	CdCO ₃ ^b	CdCl ₂ ^b
Chemical structure	Cd ^b	CdCO ₃ ^b	CdCl ₂ ^b
Identification numbers:			
CAS registry	7440-43-9 ^b	513-78-0 ^b	10108-64-2
NIOSH RTECS	No data	No data	No data
EPA hazardous waste	D006	D006	D006
OHM/TADS	No data	No data	No data
DOT/UN/NA/IMDG shipping	No data	No data	NA2570/IMCO 6.1
HSDB	282	1612	278
NCI	No data	No data	No data

4. CHEMICAL AND PHYSICAL INFORMATION

Table 4-1. Chemical Identity of Cadmium and Compounds^a

Characteristic	Information		
	Cadmium oxide	Cadmium sulfate	Cadmium sulfide
Chemical name	Cadmium oxide	Cadmium sulfate	Cadmium sulfide
Synonym(s)	Aska-Rid ^b ; cadmium fume; cadmium monoxide	Cadmium sulphate; sulfuric acid; cadmium (2+) salt	Cadmium monosulfide; cadmium yellow; cadmium orange; cadmopur yellow; greenockite ^b ; capsebon ^b
Registered trade name(s)	No data	No data	No data
Chemical formula	CdO ^b	CdSO ₄ ^b	CdS ^b
Chemical structure	CdO ^b	CdSO ₄ ^b	CdS ^b
Identification numbers:			
CAS registry	1306-19-0 ^b	10124-36-4 ^b	1306-23-6 ^b
NIOSH RTECS	No data	No data	No data
EPA hazardous waste	D006	D006	D006
OHM/TADS	No data	No data	No data
DOT/UN/NA/IMDG shipping	UN2570/IMCO 6.1	No data	No data
HSDB	1613	274	1614
NCI	No data	No data	No data

^aAll information obtained from HSDB 2008 except where noted.

^bO'Neil et al. 2006.

CAS = Chemical Abstracts Service; DOT/UN/NA/IMDG = Department of Transportation/United Nations/North America/International Maritime Dangerous Goods Code; EPA = Environmental Protection Agency; HSDB = Hazardous Substances Data Bank; NCI = National Cancer Institute; NIOSH = National Institute for Occupational Safety and Health; OHM/TADS = Oil and Hazardous Materials/Technical Assistance Data System; RTECS = Registry of Toxic Effects of Chemical Substances

4. CHEMICAL AND PHYSICAL INFORMATION

Table 4-2. Physical and Chemical Properties of Cadmium and Compounds^a

Property	Cadmium	Cadmium carbonate
Molecular weight	112.41 ^b	172.42 ^b
Color	Silver-white ^b	White ^c
Physical state	Lustrous metal ^b	Powder or rhombohedral leaflets ^b
Melting point	321 °C ^b	Decomposes at 357 °C
Boiling point	765 °C ^b	No data
Density at 20 °C	8.65 g/cm ³ at 25 °C ^b	4.58 g/cm ^{3f}
Odor	Odorless	No data
Odor threshold:		
Water	No data	No data
Air	No data	No data
Solubility:		
Water at 20 °C	Insoluble ^b	Insoluble ^f
Organic solvents	Acids, NH ₄ NO ₃ ^f	Acids, especially HNO ₃ , concentrated NH ₄ solution ^c
Partition coefficients:		
Log K _{ow}	No data	No data
Log K _{oc}	No data	No data
Vapor pressure	7.5x10 ⁻³ mmHg at 257 °C	No data
Henry's law constant at 25 °C	No data	No data
Autoignition temperature	250 °C	No data
Flashpoint	No data	No data
Flammability limits	No data	No data
Conversion factors	No data	No data
Explosive limits	No data	No data

4. CHEMICAL AND PHYSICAL INFORMATION

Table 4-2. Physical and Chemical Properties of Cadmium and Compounds^a

Property	Cadmium chloride	Cadmium oxide
Molecular weight	183.32	128.41 ^b
Color	White ^c	Dark brown ^b
Physical state	Rhombohedral crystals ^b	Infusible powder or cubic crystals ^b
Melting point	568 °C ^b	Decomposes at 950 °C
Boiling point	960 °C ^b	Decomposes at 950 °C
Density at 20 °C	4.047g/cm ³ at 25 °C ^e	Crystals 8.15 g/cm ³ ; amorphous powder 6.95 g/cm ^{3c}
Odor	Odorless ^c	Odorless
Odor threshold:		
Water	No data	No data
Air	No data	No data
Solubility:		
Water at 20 °C	Soluble ^b	Insoluble ^b
Organic solvents	Acetone, slightly soluble in MEOH and ETOH ^b	Dilute acid, slowly soluble in NH ₄ salts ^b
Partition coefficients:		
Log K _{ow}	No data	No data
Log K _{oc}	No data	No data
Vapor pressure	10 mmHg at 656 °C ^e , 40 mmHg at 736 °C ^d , 760 mmHg at 967 °C ^d	1 mmHg at 1,000 °C ^e ; 10 mm Hg at 1149 °C; 40 mm Hg at 1257 °C
Henry's law constant at 25 °C	No data	No data
Autoignition temperature	No data	No data
Flashpoint	No data	No data
Flammability limits	No data	No data
Conversion factors	No data	No data
Explosive limits	No data	No data

4. CHEMICAL AND PHYSICAL INFORMATION

Table 4-2. Physical and Chemical Properties of Cadmium and Compounds^a

Property	Cadmium sulfate	Cadmium sulfide
Molecular weight	208.47 ^b	144.48 ^b
Color	Colorless ^c	Light yellow or orange ^b ; brown ^c
Physical state	Monoclinic crystals (hydrate) ^b	Cubic or hexagonal structure ^b
Melting point	1,000 °C ^c	1,750 °C ^c
Boiling point	No data	Sublimes in N ₂ at 980 °C ^c
Density at 20 °C	4.69 g/cm ^{3b}	4.82 g/cm ³ , hexagonal structure ^b , 4.5 g/cm ³ , cubic structure ^b
Odor	Odorless	No data
Odor threshold:		
Water	No data	No data
Air	No data	No data
Solubility:		
Water at 20 °C	Soluble ^c	Soluble at 1.3 mg/L at 18 °C ^b
Organic solvents	Insoluble in alcohol ^c , acetone, ammonia ^f	Concentrated or warm dilute mineral acids ^b
Partition coefficients:		
Log K _{ow}	No data	No data
Log K _{oc}	No data	No data
Vapor pressure at 20 °C	No data	No data
Henry's law constant at 25 °C	No data	No data
Autoignition temperature	No data	No data
Flashpoint	No data	No data
Flammability limits	No data	No data
Conversion factors	No data	No data
Explosive limits	No data	No data

^aAll information from HSDB 2008, except where noted.

^bO'Neil et al. 2006.

^cSax and Lewis 2001.

^dFarnsworth 1980.

^eSax and Lewis 2000.

^fLide 2005.

5. PRODUCTION, IMPORT/EXPORT, USE, AND DISPOSAL

5.1 PRODUCTION

Cadmium is a widely but sparsely distributed element found in the earth's crust at concentrations ranging from 0.1 to 5 ppm, primarily as sulfide minerals in association with zinc ores, zinc-bearing lead ores, and or complex copper-lead-zinc ores (Morrow 2001). Approximately 3 kg of cadmium for each ton of zinc are produced (OECD 1995). About 80% of cadmium production is associated with zinc production, while the other 20% is associated with lead and copper byproduct production and the recapture of cadmium from finished products (Morrow 2001). Between 2003 and 2006, the annual cadmium refinery production in the United States declined from 1,450 to 700 metric tons, dropping 52% between 2005 and 2006 (USGS 2007, 2008). Demand for cadmium in the nickel-cadmium (Ni-Cd) battery industry is strengthening as demand in other areas, like coatings and pigments, has been decreasing due to environmental concerns and regulations. Despite this demand, primary production of cadmium may decrease as zinc prices increase, since producers may choose to discard the cadmium byproduct instead of refining it (USGS 2008).

One company produced primary cadmium in the United States during 2007: Clarksville (Zinifex Ltd.), Clarksville, Tennessee. The Big River Zinc Corporation (Korea Zinc Co, Ltd), Sauget, Illinois operation was closed in 2006, citing mine closures and the increasing price of zinc concentrate (USGS 2008). In June 2006, it was purchased by ZincOx Resources plc, Surrey, United Kingdom (USGS 2007). A third company in Ellwood, Pennsylvania, International Metals Reclamation Co. Inc. (INMETCO), recovers cadmium from spent nickel-cadmium batteries, which began reclaiming cadmium in 1995 (USGS 2007). In 2005, it was estimated that the total cadmium recovery rate was only 12%, with an estimated 40,000 tons of cadmium being disposed of in municipal waste or held in household storage or industry stockpiles between 1996 and 2005 (USGS 2007).

The following companies are currently cited as major producers of cadmium compounds: GFS Chemicals Inc., Columbus, Ohio (cadmium chloride, cadmium sulfate); CERAC Inc., Milwaukee, Wisconsin (cadmium sulfide); and EP Scientific Products, LLC (cadmium sulfide) (SRI 2007). BASF Catalysts LLC, Louisville, Kentucky was specifically cited as a major producer of cadmium sulfide/sulfoselenide pigments (SRI 2007).

[Tables 5-1](#) and [5-2](#) list the facilities in each state that manufacture or process cadmium and cadmium compounds, respectively, the intended use, and the range of maximum amounts stored on site. The data

5. PRODUCTION, IMPORT/EXPORT, USE, AND DISPOSAL

Table 5-1. Facilities that Produce, Process, or Use Cadmium

State ^a	Number of facilities	Minimum amount on site in pounds ^b	Maximum amount on site in pounds ^b	Activities and uses ^c
AL	19	0	999,999	1, 2, 3, 5, 6, 7, 8, 9, 10, 11, 12, 13, 14
AR	14	0	999,999	1, 2, 3, 5, 6, 7, 8, 10, 12, 13, 14
AZ	12	0	999,999	1, 2, 3, 4, 5, 7, 8, 9, 10, 11, 13
CA	41	0	99,999	1, 2, 3, 5, 6, 7, 8, 9, 10, 11, 12, 13, 14
CO	8	1,000	9,999,999	1, 2, 3, 4, 5, 6, 7, 8, 12
CT	5	0	99,999	7, 8, 10, 11
FL	6	0	99,999	1, 2, 3, 4, 6, 7, 8, 10, 12
GA	8	0	999,999	1, 3, 6, 8, 13, 14
IA	9	0	99,999	1, 5, 7, 8, 12, 13
ID	6	10,000	999,999	1, 3, 5, 12, 13
IL	25	0	999,999	1, 2, 3, 4, 5, 6, 7, 8, 9, 10, 11, 13, 14
IN	10	0	999,999	1, 2, 5, 7, 8, 9, 10, 12
KS	6	100	99,999	1, 3, 7, 8, 12
KY	11	0	999,999	1, 2, 3, 5, 6, 7, 8, 11
LA	7	0	999,999	1, 3, 5, 6, 8, 10, 12, 13
MA	13	0	99,999	1, 2, 3, 4, 7, 8, 10
MD	5	100	49,999,999	1, 2, 4, 5, 6, 13
MI	19	0	99,999	1, 2, 3, 5, 6, 7, 8, 10, 12, 13, 14
MN	10	0	999,999	1, 3, 4, 7, 8, 9, 10, 11, 12, 13
MO	7	0	999,999	1, 2, 3, 4, 5, 6, 8, 14
MS	7	0	9,999	5, 7, 8, 12
NC	13	0	9,999,999	1, 5, 7, 8, 9, 10, 12, 14
NE	9	100	99,999	1, 2, 5, 7, 8, 12
NH	4	0	999	1, 3, 8, 12
NJ	18	0	999,999	1, 2, 3, 4, 5, 6, 7, 8, 9, 10, 11, 12, 13
NV	2	10,000	99,999	1, 2, 3, 5, 12, 13
NY	21	0	9,999,999	2, 3, 4, 5, 6, 7, 8, 9, 10, 12, 14
OH	32	0	999,999	1, 2, 3, 4, 5, 6, 7, 8, 9, 10, 11, 12, 13, 14
OK	16	0	9,999,999	1, 2, 3, 4, 5, 6, 7, 8, 9, 12, 13
OR	7	0	9,999,999	1, 5, 8, 12
PA	35	0	9,999,999	1, 2, 3, 4, 5, 6, 7, 8, 9, 10, 11, 12, 13, 14
PR	1	0	99	8
RI	4	0	9,999	2, 3, 7, 8
SC	20	0	9,999,999	1, 3, 5, 6, 7, 8, 9, 10, 11, 12
TN	17	0	9,999,999	1, 2, 3, 4, 5, 7, 8, 9, 11, 12, 13
TX	28	0	9,999,999	1, 2, 3, 4, 5, 6, 7, 8, 10, 12, 13, 14
UT	8	0	99,999	1, 5, 6, 7, 8, 12, 13

5. PRODUCTION, IMPORT/EXPORT, USE, AND DISPOSAL

Table 5-1. Facilities that Produce, Process, or Use Cadmium

State ^a	Number of facilities	Minimum amount on site in pounds ^b	Maximum amount on site in pounds ^b	Activities and uses ^c
VA	12	0	99,999	1, 5, 7, 8, 9, 10, 11, 13
WA	5	0	9,999	1, 2, 3, 5, 10, 13
WI	14	0	49,999,999	3, 7, 8, 10, 11, 12
WV	3	100	99,999	7, 8, 12
WY	1	0	99	1, 13

^aPost office state abbreviations used.

^bAmounts on site reported by facilities in each state.

^cActivities/Uses:

- | | | |
|--------------------------|--------------------------|-----------------------------|
| 1. Produce | 6. Impurity | 11. Chemical Processing Aid |
| 2. Import | 7. Reactant | 12. Manufacturing Aid |
| 3. Onsite use/processing | 8. Formulation Component | 13. Ancillary/Other Uses |
| 4. Sale/Distribution | 9. Article Component | 14. Process Impurity |
| 5. Byproduct | 10. Repackaging | |

Source: TRI09 2011 (Data are from 2009)

5. PRODUCTION, IMPORT/EXPORT, USE, AND DISPOSAL

Table 5-2. Facilities that Produce, Process, or Use Cadmium Compounds

State ^a	Number of facilities	Minimum amount on site in pounds ^b	Maximum amount on site in pounds ^b	Activities and uses ^c
AK	14	0	499,999,999	1, 5, 7, 9, 11, 12, 14
AL	31	0	49,999,999	1, 2, 3, 4, 5, 6, 7, 8, 10, 12, 13, 14
AR	19	100	999,999	1, 2, 3, 5, 7, 8, 12, 13, 14
AZ	30	0	99,999,999	1, 2, 3, 4, 5, 6, 7, 8, 12, 13, 14
CA	28	0	49,999,999	1, 2, 3, 5, 6, 7, 8, 9, 10, 11, 12, 13
CO	10	100	9,999,999	1, 2, 3, 4, 5, 6, 7, 8, 9, 10, 12, 13, 14
CT	28	0	999,999	1, 2, 3, 4, 5, 6, 7, 8, 9, 10, 11
DE	2	100	9,999	1, 5
FL	11	0	999,999	1, 2, 3, 5, 6, 8, 12, 13, 14
GA	15	0	999,999	1, 2, 3, 5, 6, 7, 8, 13
IA	5	0	99,999	1, 5, 7, 8, 9, 12
ID	14	100	9,999,999	1, 5, 6, 7, 11, 12, 13, 14
IL	46	0	9,999,999	1, 2, 3, 4, 5, 6, 7, 8, 10, 12, 13, 14
IN	19	0	999,999	1, 5, 7, 8, 13, 14
KS	7	0	99,999	1, 7, 8, 11, 13
KY	19	100	9,999,999	1, 2, 3, 4, 5, 6, 7, 8, 12, 13
LA	12	0	999,999	1, 2, 3, 5, 7, 8, 12, 13
MA	14	0	999,999	1, 3, 4, 5, 6, 7, 8, 12, 13
MD	9	1,000	9,999,999	1, 2, 3, 4, 5, 6, 7, 8, 13
MI	24	0	99,999,999	1, 3, 5, 6, 7, 8, 10, 11, 12, 13
MN	10	100	999,999	1, 5, 7, 8, 9, 13
MO	14	0	499,999,999	1, 2, 3, 4, 5, 6, 7, 8, 13
MS	9	0	999,999	1, 5, 7, 8, 12
MT	3	1,000	9,999,999	1, 2, 3, 4, 5, 6, 13
NC	14	0	49,999,999	1, 7, 8, 13
NE	8	1,000	999,999	1, 2, 5, 8, 12, 13, 14
NH	1	1,000	9,999	7, 10
NJ	35	0	9,999,999	1, 2, 3, 4, 6, 7, 8, 9, 10, 12
NM	6	1,000	9,999,999	1, 5, 13
NV	22	100	49,999,999	1, 2, 3, 5, 6, 7, 9, 10, 12, 13, 14
NY	26	0	49,999,999	1, 2, 3, 4, 5, 6, 7, 8, 9, 10, 12, 13, 14
OH	82	0	999,999	1, 2, 3, 4, 5, 6, 7, 8, 9, 10, 11, 12, 13, 14
OK	19	0	9,999,999	1, 2, 3, 4, 5, 6, 7, 8, 9, 11, 12, 13
OR	4	100	99,999	1, 5, 8
PA	67	0	9,999,999	1, 2, 3, 4, 5, 6, 7, 8, 9, 10, 12, 13
PR	1	100	999	8

5. PRODUCTION, IMPORT/EXPORT, USE, AND DISPOSAL

Table 5-2. Facilities that Produce, Process, or Use Cadmium Compounds

State ^a	Number of facilities	Minimum amount on site in pounds ^b	Maximum amount on site in pounds ^b	Activities and uses ^c
RI	8	100	99,999	2, 3, 7, 8, 11
SC	18	0	999,999	1, 4, 5, 6, 7, 8, 11, 12, 13, 14
TN	35	0	9,999,999	1, 2, 3, 4, 5, 6, 7, 8, 11, 12, 13, 14
TX	36	0	9,999,999	1, 2, 3, 4, 5, 6, 7, 8, 9, 10, 12, 13, 14
UT	15	1,000	49,999,999	1, 5, 6, 7, 8, 12, 13
VA	11	0	99,999	1, 5, 7, 8, 12, 14
WA	17	0	999,999	1, 2, 3, 5, 6, 7, 8, 9, 11, 12, 13, 14
WI	14	100	49,999,999	1, 3, 5, 7, 8, 10, 11, 12
WV	8	0	999,999	1, 2, 3, 7, 8, 11, 12, 13

^aPost office state abbreviations used.

^bAmounts on site reported by facilities in each state.

^cActivities/Uses:

- | | | |
|--------------------------|--------------------------|-----------------------------|
| 1. Produce | 6. Impurity | 11. Chemical Processing Aid |
| 2. Import | 7. Reactant | 12. Manufacturing Aid |
| 3. Onsite use/processing | 8. Formulation Component | 13. Ancillary/Other Uses |
| 4. Sale/Distribution | 9. Article Component | 14. Process Impurity |
| 5. Byproduct | 10. Repackaging | |

Source: TRI09 2011 (Data are from 2009)

5. PRODUCTION, IMPORT/EXPORT, USE, AND DISPOSAL

listed in [Tables 5-1](#) and [5-2](#) are derived from the Toxics Release Inventory (TRI) (TRI09 2011). Because only certain types of facilities were required to report, this is not an exhaustive list.

Cadmium metal is available in purities ranging from 99.5 to 99.999% in the following grades: technical, powder, pure sticks, ingots, slabs, and high-purity crystals (<10 ppm impurities) (HSDB 2008).

Cadmium (as cadmium oxide) is obtained mainly as a byproduct during the processing of zinc-bearing ores (e.g., sphalerites), and also from the refining of lead and copper from sulfide ores (e.g., galena) (Morrow 2001). Cadmium oxide produced during roasting of ores is reduced with coke, and cadmium metal is separated by distillation or electrodeposition (Elinder 1985a). Commercial-grade cadmium oxide is available in purities ranging from 99 to 99.9999%; common impurities are lead and thallium (NTP 2005). Cadmium chloride is produced by reacting molten cadmium with chlorine gas at 600 °C or by dissolving cadmium metal or the oxide, carbonate, sulfide, or hydroxide in hydrochloric acid and subsequently vaporizing the solution to produce a hydrated crystal (HSDB 2008; IARC 1993). In preparing the anhydrous cadmium chloride salt, the hydrate is refluxed with thionyl chloride or calcined in a hydrogen chloride atmosphere (HSDB 2008). Commercial cadmium chloride is available as a hydrate mixture with a purity range of 95.0–99.999% (NTP 2005).

The commercial preparation of cadmium sulfate usually involves dissolution of the metal oxide, carbonate, or sulfide in sulfuric acid with subsequent cooling or evaporation (HSDB 2008). Anhydrous cadmium sulfate is prepared by oxidation of the sulfide or sulfite at elevated temperatures (Herron 2003); or by melting cadmium with ammonium or sodium peroxodisulfate (Schulte-Schrepping and Piscator 2002). Cadmium sulfate monohydrate, which is the cadmium compound most often marketed, is produced by evaporating a cadmium sulfate solution above 41.5 °C (Schulte-Schrepping and Piscator 2002). Cadmium sulfate is available in technical and C.P. (chemically pure) grades (Lewis 2001). Cadmium sulfide can be prepared by a direct reaction with hydrogen sulfide and cadmium vapor or between sulfur and cadmium metal or cadmium oxide (Herron 2003). Cadmium sulfide is available in technical, N.F. (national formulary grade), and high-purity (single crystals) (Lewis 2001). Cadmium carbonate is produced by heating an acidified solution of cadmium chloride and urea in a sealed tube at 200 °C, the slow absorption of carbon dioxide to cadmium oxide, or the precipitation of the hemihydrate from reaction of ammonium carbonate in cadmium ion solution (Herron 2003).

5. PRODUCTION, IMPORT/EXPORT, USE, AND DISPOSAL

5.2 IMPORT/EXPORT

Imports of cadmium into the United States declined steadily from 1994 through 1998, dropping from 1,110 metric tons per year to an estimated 650 metric tons in 1998 (USGS 1999). In 1986, imports of cadmium metal for consumption increased significantly to 3,000 metric tons, but continually decreased into the 1990s. From 2003 to 2005, cadmium imports of metal, alloys, and scrap increased from 112 to 288 tons, 74–207 tons of which were metal-only imports (USGS 2008). Cadmium imports peaked in 2005 and then declined through 2007, with 172 tons of cadmium metal only and 174 tons of metal, alloys, and scrap imported (USGS 2008). The principal supplying countries were Australia (41%), Canada (20%), China (10%), and Peru (9%) (USGS 2008).

In the mid-1990s, exports varied widely from 38 metric tons in 1993, to 1,450 metric tons in 1994, to 550 metric tons in 1997. In 2003, cadmium exports (reported as metal, alloys, and scraps) were 615 tons, with exports decreasing to only 154 tons the following year (USGS 2008). Exports surged again in 2005 to 686 tons, but have since been steadily decreasing from 483 tons in 2006 to 304 tons in 2007 (USGS 2008).

5.3 USE

Cadmium, its alloys, and its compounds are used in a variety of consumer and industrial materials. The dominant use of cadmium is in active electrode materials in Ni-Cd batteries (83% of total cadmium use) (USGS 2008). Cadmium demand for other uses such as pigments for plastics, ceramics, and glasses; stabilizers for polyvinyl chloride (PVC) against heat and light; engineering coatings on steel and some nonferrous metals; and components of various specialized alloys have been decreasing. (Elinder 1992; IARC 1993; Thornton 1992; USGS 2008). Cadmium salts have been used in a limited capacity as a fungicide for golf courses and home lawns (EPA 2006b). Cadmium chloride is used in photography, photocopying, dyeing, calico printing, vacuum tube manufacture, pigment manufacture, galvanoplasty, lubricants, ice-nucleation agents, and in the manufacture of special mirrors (Herron 2003). However, the significance of cadmium chloride as a commercial product is declining (IARC 1993).

Cadmium-based colorants are used mainly in engineering plastics, ceramics, glasses, and enamels (IARC 1993; OECD 1995). Cadmium sulfide is especially important in this industry, especially in glasses and plastics; however, environmental and health concerns have contributed to a decrease in its production (Herron 2003). Cadmium sulfide (yellow) and cadmium selenide (red) are combined to create solid C.P. toners ranging in color from yellows and oranges to reds and maroons (Herron 2003). Cadmium

5. PRODUCTION, IMPORT/EXPORT, USE, AND DISPOSAL

sulfide and cadmium telluride are used in solar cells and a variety of electronic devices which depend on cadmium's semiconducting properties (Herron 2003; IARC 1993; OECD 1995). The photoconductive and electroluminescent properties of cadmium sulfide have been applied in manufacturing a variety of consumer goods (IARC 1993). Cadmium sulfate solution is used in standard Weston cells (Herron 2003).

Though cadmium metal consumption for batteries has grown steadily since the 1980s and currently consumes 83% of the cadmium produced, other uses of cadmium began declining in the mid 1990s. Pigment, stabilizer, coating, and alloy markets for cadmium are decreasing due to environmental concerns (USGS 1997, 2008). Proposed legislation, particularly in the European Union, restricting cadmium in consumer products may have a negative effect on cadmium demand (USGS 2008). Excessive exports from Bulgaria and Russia in 1997 caused a drop in the average price of cadmium from \$1.84 per pound in 1995 to \$0.51 per pound in 1997. Also, Ni-Cd batteries have been replaced in some markets by lithium-ion and nickel metal hydride batteries (USGS 2008). As of 2006, Ni-Cd batteries made up 18% of the rechargeable battery market, down from 56% in 1996 with global sales decreasing 16% between 2005 and 2006 (USGS 2008). Despite this trend, demand for cadmium may increase due to new market opportunities for Ni-Cd batteries (USGS 2008). Regulations by local authorities have forced the recycling of cadmium in Ni-Cd batteries, further depressing the demand for primary cadmium metal (USGS 1999).

5.4 DISPOSAL

Cadmium-containing wastes are subject to regulations concerning their treatment, storage, and disposal (see Chapter 8) (EPA 1982a; HSDB 2008; U.S. Bureau of Mines 1990). In many states, the disposal of Ni-Cd batteries as municipal waste is prohibited (USGS 2007). Incineration of municipal wastes, particularly from older, poorly controlled facilities, is a potential environmental source of cadmium. In modern incineration plants, about 99.9% of cadmium was captured in boilers and control equipment (OECD 1995).

A range of physicochemical processes is available for treatment of cadmium in liquid waste process streams, including ion exchange, electrolysis, cementation, and adsorption. Both ion exchange and sulfide precipitation are used as alternate processes aimed at achieving low cadmium residuals in liquid wastes (UN 1985). Combining processes, for example, conducting the primary precipitation of cadmium as hydroxide followed by secondary precipitation of residual cadmium as sulfide, has also been adopted. The more general application of the sulfide precipitation technique, however, is constrained due to a

5. PRODUCTION, IMPORT/EXPORT, USE, AND DISPOSAL

tendency for formation of colloidal precipitate, the toxicity and odor of hydrogen sulfide, and the necessity to oxidize residual sulfide occurring in emissions prior to discharge (UN 1985).

The most widely used treatment process involves the alkaline precipitation of cadmium as hydroxide or basic salts (UN 1985). Removal of specific metal species during hydroxide precipitation is pH-dependent, and some components of the waste stream can influence the solubility of cadmium hydroxide. After filtration, the sludge formed from the conversion of soluble cadmium compounds to insoluble compounds can be deposited in a suitable landfill (UN 1985).

Various cadmium-bearing wastes are subject to aggressive leaching in refuse media, particularly under aerobic conditions (UN 1985). While liquid wastes are banned from land disposal, the leaching tendency is accentuated in the presence of brine solutions. Also, the mobility of cadmium in landfill conditions could be enhanced in the presence of mineral acids, which tend to solubilize cadmium compounds, or amine-containing materials, which tend to complex cadmium ions. Waste containing mineral acids, cyanides, organic solvents, and amine-type substances should not be landfilled near cadmium-bearing wastes (UN 1985).

In the laboratory, a recommended method for recovering cadmium from small quantities of cadmium oxide wastes uses a minimum amount of concentrated nitric acid to form nitrates. The solution is evaporated in a hood to form a thin paste, and then diluted with water and saturated with hydrogen sulfide. After the filtration, the precipitate is washed, dried, and returned to the supplier (UN 1985).

Cadmium recovery from scrap metals and batteries is becoming increasingly popular, with the main emphasis being on recycling Ni-Cd batteries (Morrow 2001). Battery recycling is relatively easy and can be achieved using pyrometallurgical (high temperature) or hydrometallurgical (wet chemical) processes (Morrow 2001). In these processes, the metallic waste that contains iron, nickel, cadmium, and their oxides and hydroxides are separated from the other battery components and then converted back to a metal that has a technical purity required for the production of new batteries (Morrow 2001). Cadmium-based coatings can be recycled using electric-arc furnace (EAF) dust, which is obtained through the remelting of scrap steel that contains cadmium coatings and cadmium impurities (Morrow 2001). INMETCO in Ellwood, Pennsylvania recovers cadmium from spent Ni-Cd batteries, and has developed several collection programs to help facilitate battery recycling (USGS 2007). Although participation in battery recycling has increased in businesses, communities, and retailers, the total recovery of cadmium in 2005 was only 12% (USGS 2007).

5. PRODUCTION, IMPORT/EXPORT, USE, AND DISPOSAL

This page is intentionally blank.

6. POTENTIAL FOR HUMAN EXPOSURE

6.1 OVERVIEW

Cadmium has been identified in at least 1,014 of the 1,669 hazardous waste sites that have been proposed for inclusion on the EPA National Priorities List (NPL) (HazDat 2007). Cadmium compounds have been identified in at least 3 of the 1,669 hazardous waste sites. However, the number of sites evaluated for cadmium is not known. The frequency of these sites can be seen in [Figures 6-1](#) and [6-2](#). Of the 1,014 sites where cadmium has been identified, 1,005 are located within the United States, 6 are located in the Commonwealth of Puerto Rico (not shown), 2 are located in Guam, and 1 is located in the Virgin Islands. All sites where cadmium compounds were detected are located in the United States.

Cadmium occurs in the earth's crust at an abundance of 0.1–0.5 ppm and is commonly associated with zinc, lead, and copper ores. It is also a natural constituent of ocean water, with average levels between <5 and 110 ng/L; with higher levels reported near coastal areas and in marine phosphates and phosphorites (Morrow 2001). Natural emissions of cadmium to the environment can result from volcanic eruptions, forest fires, generation of sea salt aerosols, or other natural phenomena (EPA 1985a; Morrow 2001; Shevchenko et al. 2003). Cadmium is refined and consumed for use in batteries (83%), pigments (8%), coatings and platings (7%), stabilizers for plastics (1.2%), and nonferrous alloys, photovoltaic devices, and other (0.8%) (USGS 2008). Nonferrous metal mining and refining, manufacture and application of phosphate fertilizers, fossil fuel combustion, and waste incineration and disposal are the main anthropogenic sources of cadmium in the environment.

Cadmium can be released to the atmosphere through metal production activities, fossil fuel combustion, and waste incineration. The main cadmium compounds found in air are cadmium oxide, chloride, and sulfate, and these compounds are expected to undergo minimal transformation in the atmosphere (EPA 1980d). The major fate of cadmium in air is through transport and deposition. Cadmium can travel long distances in the atmosphere and then deposit (wet or dry) onto surface soils and water, which can result in elevated cadmium levels even in remote locations (Shevchenko et al. 2003). Results from the 2006 final report of EPA's Urban Air Toxic Monitoring program reported average daily cadmium levels of <0.01 $\mu\text{g}/\text{m}^3$ at several monitoring sites throughout the United States (EPA 2007). These sites include: Bountiful, Utah; Northbrook, Illinois; Austin, Texas; St. Louis, Missouri; Indianapolis, Indiana; and Birmingham, Alabama (EPA 2007). Atmospheric concentrations of cadmium are generally highest in the vicinity of cadmium-emitting industries (Elinder 1985a; Pirrone et al. 1996). Due to advances in pollution control technology, cadmium emissions to air are not expected to increase, even though

6. POTENTIAL FOR HUMAN EXPOSURE

Figure 6-1. Frequency of NPL Sites with Cadmium Contamination

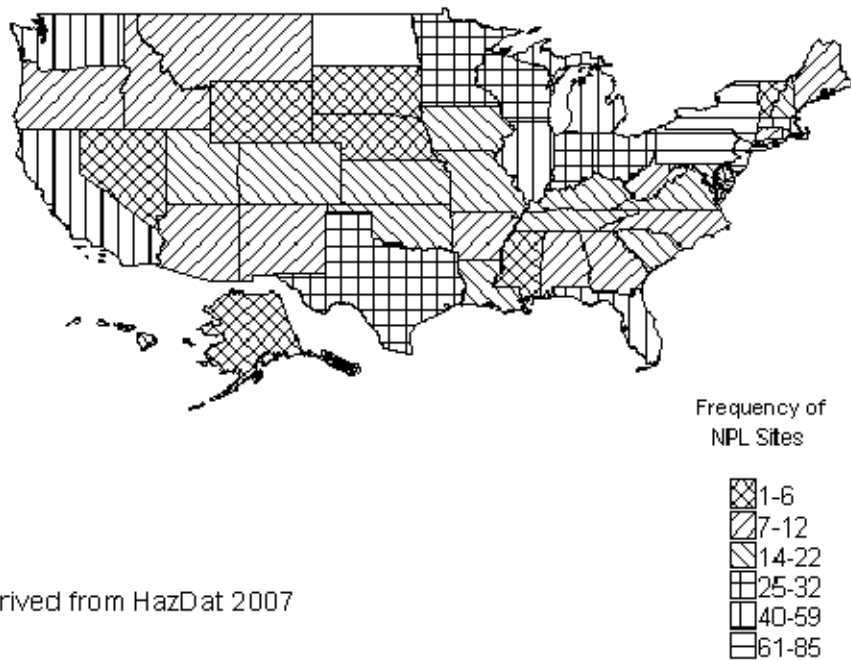

Derived from HazDat 2007

6. POTENTIAL FOR HUMAN EXPOSURE

Figure 6-2. Frequency of NPL Sites with Cadmium Compounds Contamination

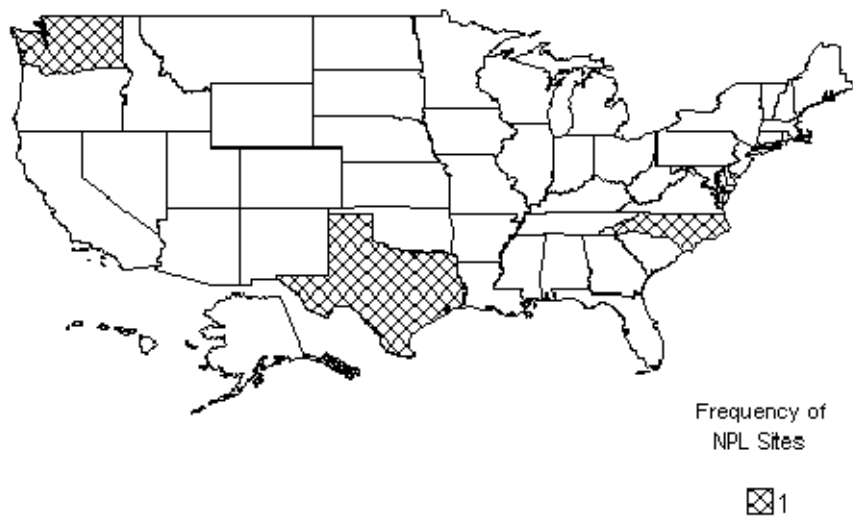

Derived from HazDat 2007

6. POTENTIAL FOR HUMAN EXPOSURE

cadmium-emitting industries are expected to grow (Herron 2003; Morrow 2010; Schulte-Schrepping and Piscator 2002). Except for those who live near cadmium-emitting industries, inhalation of cadmium in the ambient air is not a major source of exposure.

The main sources of cadmium to soil include atmospheric deposition and direct application methods such as phosphate fertilizer use and sewage sludge disposal. Some phosphate fertilizers can contain up to 300 mg Cd/kg (Alloway and Steinnes 1999). Wet and dry deposition of cadmium from the atmosphere may also contribute sizable amounts of cadmium to soil in the areas surrounding sources of atmospheric emissions (EPA 1985a; Mielke et al. 1991). Cadmium's mobility in soil depends on several factors including the pH of the soil and the availability of organic matter. Generally, cadmium will bind strongly to organic matter and this will, for the most part, immobilize cadmium (Autier and White 2004). However, immobilized cadmium is available to plant life and can easily enter the food supply. Cadmium in soil tends to be more available when the soil pH is low (acidic) (Elinder 1992).

Water sources near cadmium-emitting industries, both with historic and current operations, have shown a marked elevation of cadmium in water sediments and aquatic organisms (Angelo et al. 2007; Arnason and Fletcher 2003; Brumbaugh et al. 2005; Mason et al. 2000; Paulson 1997). In surface water and groundwater, cadmium can exist as the hydrated ion or as ionic complexes with other inorganic or organic substances. While soluble forms may migrate in water, cadmium is relatively nonmobile in insoluble complexes or adsorbed to sediments. Cadmium is taken up and retained by aquatic and terrestrial plants and is concentrated in the liver and kidney of animals that eat the plants (Elinder 1985a).

For the U.S. population, cadmium exposure through the drinking water supply is of minor concern. EPA requires water suppliers to limit the cadmium concentration in water to $<5 \mu\text{g/L}$ (EPA 2006a).

In the United States, the largest source of cadmium exposure for nonsmoking adults and children is through dietary intake (NTP 2005). Based on the mean cadmium daily intakes of males and females aged 6–60 years reported by Choudhury et al. (2001), age-weighted mean cadmium intakes of $0.35 \mu\text{g/kg/day}$ for males and $0.30 \mu\text{g/kg/day}$ for females were calculated for U.S. nonsmokers. In general, vegetables, particularly leafy vegetables such as lettuce (0.051 mg/kg) and spinach (0.124 mg/kg), have the highest concentrations of cadmium; the concentrations of cadmium in all vegetables ranged from 0.001 to 0.124 mg/kg (FDA 2010; Morrow 2001). Peanuts, soybeans, and sunflower seeds have naturally high levels of cadmium (Morrow 2001); the mean concentration of cadmium in legumes and nuts ranged from 0.001 to 0.054 mg/kg (FDA 2010). People who regularly consume shellfish and organ meats (liver and

6. POTENTIAL FOR HUMAN EXPOSURE

kidney) have an increased risk of cadmium exposure, as these organisms tend to accumulate cadmium (Elinder 1985a).

Tobacco leaves naturally accumulate cadmium (Morrow 2001). Cadmium levels in cigarettes vary greatly depending on the source of production. Cigarettes produced in Mexico were found to have the highest level of cadmium per cigarette (arithmetic mean [AM] \pm arithmetic standard deviation [ASD] = 2.03 $\mu\text{g}/\text{cigarette} \pm 0.33$), while cigarettes from India were found to have the lowest (arithmetic mean \pm arithmetic standard deviation = 0.35 $\mu\text{g}/\text{cigarette} \pm 0.09$). The arithmetic mean for the United States was 1.07 $\mu\text{g}/\text{cigarette} \pm 0.11$ (Watanabe et al. 1987). Tobacco contains approximately 0.5–2.0 μg cadmium per cigarette, and about 10% is inhaled when smoked (Morrow 2010). The geometric mean blood cadmium level for the heavy smoker subgroup in New York City was reported as 1.58 $\mu\text{g}/\text{L}$, compared to the geometric mean of 0.77 $\mu\text{g}/\text{L}$ for all New York City adults (McKelvey et al. 2007).

6.2 RELEASES TO THE ENVIRONMENT

The Toxics Release Inventory (TRI) data should be used with caution because only certain types of facilities are required to report (EPA 2005). This is not an exhaustive list. Manufacturing and processing facilities are required to report information to the TRI only if they employ 10 or more full-time employees; if their facility is included in Standard Industrial Classification (SIC) Codes 10 (except 1011, 1081, and 1094), 12 (except 1241), 20–39, 4911 (limited to facilities that combust coal and/or oil for the purpose of generating electricity for distribution in commerce), 4931 (limited to facilities that combust coal and/or oil for the purpose of generating electricity for distribution in commerce), 4939 (limited to facilities that combust coal and/or oil for the purpose of generating electricity for distribution in commerce), 4953 (limited to facilities regulated under RCRA Subtitle C, 42 U.S.C. section 6921 et seq.), 5169, 5171, and 7389 (limited S.C. section 6921 et seq.), 5169, 5171, and 7389 (limited to facilities primarily engaged in solvents recovery services on a contract or fee basis); and if their facility produces, imports, or processes $\geq 25,000$ pounds of any TRI chemical or otherwise uses $>10,000$ pounds of a TRI chemical in a calendar year (EPA 2005).

Additional releases of cadmium to the environment occur from natural sources and from processes such as combustion of fossil fuel, incineration of municipal or industrial wastes, or land application of sewage sludge or fertilizer (EPA 1985a). Quantitative information on releases of cadmium to specific environmental media is discussed below.

6. POTENTIAL FOR HUMAN EXPOSURE

6.2.1 Air

Estimated releases of 731 pounds (~0.3 metric tons) of cadmium to the atmosphere from 41 domestic manufacturing and processing facilities in 2009, accounted for about 0.18% of the estimated total environmental releases of cadmium from facilities required to report to the TRI (TRI09 2011). These releases are summarized in [Table 6-1](#). Estimated releases of 11,567 pounds (~5.2 metric tons) of cadmium compounds to the atmosphere from 85 domestic manufacturing and processing facilities in 2009, accounted for about 0.55% of the estimated total environmental releases of cadmium from facilities required to report to the TRI (TRI09 2011). These releases are summarized in [Table 6-2](#).

Cadmium is released to the atmosphere from both natural and anthropogenic sources. Cadmium is widely distributed in the earth's crust (EPA 1985a) with concentrations reported between 0.1 and 0.5 ppm and higher levels in sedimentary rocks (Morrow 2001). Consequently, cadmium may be released to the air from entrainment of dust particles, volcanic eruptions, forest fires, or other natural phenomena (EPA 1985a; Morrow 2001). Cadmium exists in ocean waters at average levels ranging from <5 to 110 ng/L and may transport to the atmosphere through natural processes like generation of sea-salt aerosols (Morrow 2001; Shevchenko et al. 2003). Increased cadmium levels in the air over the Russian Arctic have been detected during the summer and autumn seasons and are believed to be attributed to natural processes, while the levels detected during the winter and spring seasons were due to anthropogenic sources (Shevchenko et al. 2003).

However, industrial activities are the main sources of cadmium release to air (EPA 1985a), and emissions from anthropogenic sources have been found to exceed those of natural origin by an order of magnitude (IARC 1993). Major industrial sources of cadmium emissions include zinc, lead, copper, and cadmium smelting operations; coal and oil-fired boiler; other urban and industrial emissions; phosphate fertilizer manufacture; road dust; and municipal and sewage sludge incinerators (Alloway and Steinnes 1999; Morrow 2001). Emission of cadmium through nonferrous metal production in 1995 was highest in Asia with 1,176 tonnes and North America emitting 191 tonnes. Estimated emissions of cadmium from municipal waste and sewage sludge incineration in North America were 8 and 7 tonnes/year, respectively, in the mid-1990s (Pacyna and Pacyna 2001). Additional sources that contribute negligible amounts of cadmium are rubber tire wear, motor oil combustion, cement manufacturing, and fertilizer and fungicide application (Wilber et al. 1992). Average cadmium emission factors for combustion of coal and oil are about 0.1 and 0.05 g/ton, respectively. Cement production releases an estimated 0.01 g/ton cement and

6. POTENTIAL FOR HUMAN EXPOSURE

Table 6-1. Releases to the Environment from Facilities that Produce, Process, or Use Cadmium^a

State ^c	RF ^d	Air ^e	Reported amounts released in pounds per year ^b				Total release		
			Water ^f	UI ^g	Land ^h	Other ⁱ	On-site ^j	Off-site ^k	On- and off-site
WI	1	35	0	0	181	0	35	181	216
Total	41	731	338	142,567	253,065	6,059	357,597	45,164	402,760

^aThe TRI data should be used with caution since only certain types of facilities are required to report. This is not an exhaustive list. Data are rounded to nearest whole number.

^bData in TRI are maximum amounts released by each facility.

^cPost office state abbreviations are used.

^dNumber of reporting facilities.

^eThe sum of fugitive and point source releases are included in releases to air by a given facility.

^fSurface water discharges, waste water treatment-(metals only), and publicly owned treatment works (POTWs) (metal and metal compounds).

^gClass I wells, Class II-V wells, and underground injection.

^hResource Conservation and Recovery Act (RCRA) subtitle C landfills; other onsite landfills, land treatment, surface impoundments, other land disposal, other landfills.

ⁱStorage only, solidification/stabilization (metals only), other off-site management, transfers to waste broker for disposal, unknown

^jThe sum of all releases of the chemical to air, land, water, and underground injection wells.

^kTotal amount of chemical transferred off-site, including to POTWs.

RF = reporting facilities; UI = underground injection

Source: TRI09 2011 (Data are from 2009)

6. POTENTIAL FOR HUMAN EXPOSURE

Table 6-2. Releases to the Environment from Facilities that Produce, Process, or Use Cadmium Compounds^a

State ^c	RF ^d	Reported amounts released in pounds per year ^b							
		Air ^e	Water ^f	UI ^g	Land ^h	Other ⁱ	Total release		
							On-site ^j	Off-site ^k	On- and off-site
AK	3	129	3	0	61,176	0	61,308	0	61,308
AL	4	221	122	0	698,581	0	698,681	243	698,924
AR	1	0	0	0	0	131	0	131	131
AZ	3	611	5	0	63,392	0	63,753	255	64,008
CA	1	0	0	0	115	0	0	115	115
CO	1	1	0	0	0	0	1	0	1
CT	1	0	0	0	0	0	0	0	0
FL	1	0	0	0	0	0	0	0	0
GA	3	8	3	0	0	0	9	3	11
ID	2	6,409	6	0	386,455	0	392,870	0	392,870
IL	5	59	117	215	33,651	1,553	1,289	34,306	35,595
IN	3	76	6	0	13,361	41	82	13,402	13,484
LA	1	0	0	0	0	0	0	0	0
MA	3	25	251	0	0	1,021	25	1,272	1,297
MD	1	0	0	0	0	12,400	0	12,400	12,400
MI	1	0	5	0	250	0	0	255	255
MO	1	593	265	0	6,178	9	6,987	58	7,045
NC	1	0	0	0	0	0	0	0	0
NE	1	250	0	0	250	21,000	250	21,250	21,500
NJ	2	5	1	0	1,488	140	5	1,629	1,634
NV	4	40	0	0	165,471	0	165,506	5	165,511
NY	1	0	21	0	0	0	21	0	21
OH	10	37	102	0	4,264	15,604	1,471	18,536	20,007
OK	1	31	0	0	0	0	31	0	31
PA	8	646	326	0	2,596	9,442	721	12,289	13,010
SC	1	255	10	0	6,165	0	265	6,165	6,430
TN	5	1,997	597	0	192,927	428	195,516	433	195,949
TX	7	30	335	2,118	334,113	2,583	334,650	4,529	339,179
UT	4	130	133	0	54,954	107	55,217	107	55,324
WA	1	2	2	0	0	5	4	5	9
WI	3	10	27	0	1	6,623	10	6,651	6,661

6. POTENTIAL FOR HUMAN EXPOSURE

Table 6-2. Releases to the Environment from Facilities that Produce, Process, or Use Cadmium Compounds^a

State ^c	RF ^d	Reported amounts released in pounds per year ^b							Total release	
		Air ^e	Water ^f	UI ^g	Land ^h	Other ⁱ	On-site ^j	Off-site ^k	On- and off-site	
WV	1	2	7	0	1,018	0	518	509	1,027	
Total	85	11,567	2,346	2,333	2,026,406	71,087	1,979,190	134,549	2,113,739	

^aThe TRI data should be used with caution since only certain types of facilities are required to report. This is not an exhaustive list. Data are rounded to nearest whole number.

^bData in TRI are maximum amounts released by each facility.

^cPost office state abbreviations are used.

^dNumber of reporting facilities.

^eThe sum of fugitive and point source releases are included in releases to air by a given facility.

^fSurface water discharges, waste water treatment-(metals only), and publicly owned treatment works (POTWs) (metal and metal compounds).

^gClass I wells, Class II-V wells, and underground injection.

^hResource Conservation and Recovery Act (RCRA) subtitle C landfills; other onsite landfills, land treatment, surface impoundments, other land disposal, other landfills.

ⁱStorage only, solidification/stabilization (metals only), other off-site management, transfers to waste broker for disposal, unknown

^jThe sum of all releases of the chemical to air, land, water, and underground injection wells.

^kTotal amount of chemical transferred off-site, including to POTWs.

RF = reporting facilities; UI = underground injection

Source: TRI09 2011 (Data are from 2009)

6. POTENTIAL FOR HUMAN EXPOSURE

pig iron and steel production releases an estimated 0.1 g/ton (Pacyna and Pacyna 2001). Atmospheric cadmium exists mainly in the forms of cadmium oxide and cadmium chloride (Morrow 2001).

Cadmium emissions have decreased dramatically since the 1960s as primary cadmium producers now use the electrolytic process and pollution control technologies such as agglomeration, electrostatic purification of gas exhaust, and exhaust filtration have been implemented (Herron 2003; Morrow 2001; Schulte-Schrepping and Piscator 2002). Anthropogenic cadmium emissions have decreased by over 90% in the last 50 years (Morrow 2010).

There is a potential for release of cadmium to air from hazardous waste sites. Cadmium has been detected in air samples collected at 50 of the 1,014 NPL hazardous waste sites where cadmium was detected in some environmental medium (HazDat 2007). Cadmium compounds were detected in air samples collected at one of three NPL hazardous waste sites where cadmium compounds were detected. The HazDat information used includes data from NPL sites only.

6.2.2 Water

Estimated releases of 338 pounds (~0.15 metric tons) of cadmium to surface water from 41 domestic manufacturing and processing facilities in 2009, accounted for about 0.084% of the estimated total environmental releases from facilities required to report to the TRI. This estimate includes releases to wastewater treatment and publicly owned treatment works (TRI09 2011). These releases are summarized in [Table 6-1](#). Estimated releases of 2,346 pounds (~1.1 metric tons) of cadmium compounds to surface water from 85 domestic manufacturing and processing facilities in 2009, accounted for about 0.11% of the estimated total environmental releases from facilities required to report to the TRI. This estimate includes releases to wastewater treatment and publicly owned treatment works (TRI09 2011). These releases are summarized in [Table 6-2](#).

Cadmium may be released to water by natural weathering processes, by discharge from industrial facilities or sewage treatment plants, atmospheric deposition, by leaching from landfills or soil, or phosphate fertilizers (EPA 1981a, 1985a; IJC 1989; Morrow 2001). Cadmium may also leach into drinking water supplies from pipes in the distribution system (Elinder 1985a). The average level of cadmium in ocean water has been reported between <5 and 110 ng/L, with higher levels reported near coastal areas and in marine phosphates and phosphorites (Morrow 2001).

6. POTENTIAL FOR HUMAN EXPOSURE

Smelting of nonferrous metal ores has been estimated to be the largest anthropogenic source of cadmium released into the aquatic environment. Cadmium contamination can result from entry into aquifers of mine drainage water, waste water, tailing pond overflow, and rainwater runoff from mine areas (IARC 1993). The upper Clark Fork River in Montana is contaminated with large amounts of cadmium from past mining activities between 1880 and 1972. While mining wastes are no longer released into the river, an estimated 14.5 million cubic meters of tailings have been incorporated into the river bed, floodplain, and reservoir sediments (Canfield et al. 1994). Other human sources include spent solutions from plating operations and phosphate fertilizers. Cadmium constitutes up to 35 mg/kg of phosphorous pentoxide, a component of phosphate-based fertilizers, in the United States (IARC 1993). Atmospheric fallout of cadmium to aquatic systems is another major source of cadmium to the environment (IARC 1993; Muntau and Baudo 1992).

A large proportion of the cadmium load in the aquatic environment is due to diffuse pollution originating from many different sources rather than from point sources. In the estuarine portion of the Hudson River, it has been found that more cadmium was released from agricultural and urban run-off than from industrial and municipal sewage treatment plants (Muntau and Baudo 1992). In an urban environment, there are also multiple sources of cadmium to waste water. In an urban waste water study conducted in the United Kingdom, cadmium was detected in the waste water originating from industrial, commercial, and private sectors, with the highest average cadmium concentration detected in the waste water of new (<5 years old) private housing (0.375 µg/L) (Rule et al. 2006).

There is also a potential for release of cadmium to water from hazardous waste sites. Cadmium has been detected in surface water samples collected at 354 of the 1,014 NPL hazardous waste sites, and in groundwater samples collected at 675 of the 1,014 NPL hazardous waste sites where cadmium has been detected in some environmental medium (HazDat 2007). The HazDat information used includes data from NPL sites only.

6.2.3 Soil

Estimated releases of 253,065 pounds (~115 metric tons) of cadmium to soils from 41 domestic manufacturing and processing facilities in 2009, accounted for about 63% of the estimated total environmental releases of cadmium from facilities required to report to the TRI (TRI09 2011). An additional 142,567 pounds (~65 metric tons), constituting about 35% of the total environmental emissions, were released via underground injection and to Class I wells, Class II-V wells (TRI09 2011).

6. POTENTIAL FOR HUMAN EXPOSURE

These releases are summarized in [Table 6-1](#). Estimated releases of 2,026,406 pounds (~919 metric tons) of cadmium compounds to soils from 85 domestic manufacturing and processing facilities in 2009, accounted for about 96% of the estimated total environmental releases from facilities required to report to the TRI. An additional 2,333 pounds (~1 metric tons), constituting about 0.1% of the total environmental emissions, were released via underground injection and to Class I wells, Class II-V wells (TRI09 2011). These releases are summarized in [Table 6-2](#).

Major sources of cadmium to soil include atmospheric emissions, direct application, and accidental or fugitive contamination. Direct application emissions refer to phosphate fertilizers, phosphogypsum and other byproduct gypsums (from the manufacture of phosphoric acid and phosphorite), sewage sludges, composted municipal solid waste, and residual ashes from wood, coal, or other types of combustion. Contamination sources include industrial site contamination, mine waste dumps, and corrosion of metal structures (Alloway and Steinnes 1999).

Approximately 61% of the 5.6 million dry tons of sewage sludge produced annually in the United States is landspread (NRC 2002). The EPA ceiling limit for the cadmium content of sludge applied to land is 85 mg/kg in sewage sludge, the cumulative pollution loading rate is 39 kg/ha, and the maximum annual cadmium loading of 1.9 kg-ha⁻¹·year⁻¹ (EPA 2011a). Estimated cadmium concentrations in sewage sludge range from 0.21 to >11.8 mg/kg (EPA 2009a). Sludges from treatment plants that serve cadmium industries (i.e., battery manufacturing) tend to have higher levels of cadmium (Alloway and Steinnes 1999).

Phosphate fertilizers are a major source of cadmium input to agricultural soils (EPA 1985a). The natural cadmium concentration in phosphates ranges from 3 to 100 µg/g (EPA 1985a; Singh 1994). Some may contain up to 300 mg Cd/kg (Alloway and Steinnes 1999). It is estimated that over 8 million tons of phosphate fertilizer were used in the United States in 2010 (USDA 2012). Any soil treated with these fertilizers will have a cadmium input, but exactly how much will vary (Alloway and Steinnes 1999). For example, continuous fertilization with a high rate of triple super-phosphate (1,175 kg P-ha⁻¹·year⁻¹) for a period of 36 years resulted in a 14-fold increase in cadmium content of surface soils (Singh 1994).

Wet and dry deposition of cadmium from the atmosphere may also contribute sizable amounts of cadmium to soil in the areas surrounding sources of atmospheric emissions, such as incinerators and vehicular traffic, which may release cadmium from burned fuel and tire wear (EPA 1985a; Mielke et al. 1991). High-temperature sources, such as smelters and incinerators, release small particles that are ideal

6. POTENTIAL FOR HUMAN EXPOSURE

for long-range atmospheric transport. Also, vapors emitted from high temperature processes will preferentially condense onto smaller particles, thus making vapor emissions available for transport (Steinnes and Friedland 2006). Aerosols containing cadmium can be carried very long distances in the atmosphere before being deposited to soils. In the soils in southern Norway, most of the cadmium and other heavy metals that are deposited from the atmosphere originate from other parts of Europe (Alloway and Steinnes 1999). Long-range atmospheric deposition is more evident in organic-rich soils as they have a tendency to concentrate heavy metals (Steinnes and Friedland 2006).

There is also a potential for release of cadmium to soil from hazardous waste sites. Cadmium has been detected in soil samples collected at 606 of the 1,014 NPL hazardous waste sites and in sediment samples collected at 392 of the 1,014 NPL hazardous waste sites where cadmium has been detected in some environmental medium (HazDat 2007). The HazDat information used includes data from NPL sites only.

6.3 ENVIRONMENTAL FATE

6.3.1 Transport and Partitioning

Cadmium is expected to partition primarily to soil (80–90%) when released to the environment. Although particulate and vapor cadmium may be released to the air, the net flux to soil will be positive as cadmium will eventually deposit onto soils (Morrow 2001; Wilber et al. 1992).

Cadmium and cadmium compounds have negligible vapor pressures (see [Table 4-2](#)) but can be released to the environment by emissions from municipal waste incinerators, nonferrous metal production, and other high-temperature processes (Morrow 2001). Cadmium emitted to the atmosphere from combustion processes condense onto very small particulates that are in the respirable range (<10 μm) and are subject to long-range transport (Steinnes and Friedland 2006; Wilber et al. 1992). These cadmium pollutants may be transported from a hundred to a few thousand kilometers and have a typical atmospheric residence time of about 1–10 days before deposition occurs (EPA 1980d). Larger cadmium-containing particles from smelters and other pollutant sources are also removed from the atmosphere by gravitational settling, with substantial deposition in areas downwind of the pollutant source. Cadmium-containing particulates may dissolve in atmospheric water droplets and be removed from air by wet deposition.

Cadmium is more mobile in aquatic environments than most other heavy metals (e.g., lead). In most natural surface waters, the affinities of complexing ligands for cadmium generally follow the order of humic acids > CO_3^{2-} > $\text{OH}^- \geq \text{Cl}^- \geq \text{SO}_4^{2-}$ (EPA 1979). In unpolluted natural waters, most cadmium

6. POTENTIAL FOR HUMAN EXPOSURE

transported in the water column will exist in the dissolved state as the hydrated ion $\text{Cd}(\text{H}_2\text{O})_6^{2+}$. Minor amounts of cadmium are transported with the coarse particulates, and only a small fraction is transported with the colloids. In unpolluted waters, cadmium can be removed from solution by exchange of cadmium for calcium in the lattice structure of carbonate minerals (EPA 1979). In polluted or organic-rich waters, adsorption of cadmium by humic substances and other organic complexing agents plays a dominant role in transport, partitioning, and remobilization of cadmium (EPA 1979). Cadmium concentration in water is inversely related to the pH and the concentration of organic material in the water (EPA 1979). Because cadmium exists only in the +2 oxidation state in water, aqueous cadmium is not strongly influenced by the oxidizing or reducing potential of the water. However, under reducing conditions, cadmium may form cadmium sulfide, which is poorly soluble and tends to precipitate (EPA 1983c; McComish and Ong 1988). Free (ionic) cadmium seems to be the toxic form and becomes much more prevalent at low salinity (Sprague 1986). Cadmium has a relatively long residence time in aquatic systems. In Lake Michigan, a mean residence time of 4–10 years was calculated for cadmium compared to 22 years calculated for mercury (Wester et al. 1992).

Precipitation and sorption to mineral surfaces, hydrous metal oxides, and organic materials are the most important processes for removal of cadmium to bed sediments. Humic acid is the major component of sediment responsible for adsorption. Sorption increases as the pH increases (EPA 1979). Sediment bacteria may also assist in the partitioning of cadmium from water to sediments (Burke and Pfister 1988). Both cadmium-sensitive and cadmium-resistant bacteria reduced the cadmium concentration in the water column from 1 ppm to between 0.2 and 0.6 ppm, with a corresponding increase in cadmium concentration in the sediments in the simulated environment (Burke and Pfister 1988). Studies indicate that concentrations of cadmium in sediments are at least one order of magnitude higher than in the overlying water (EPA 1979). The mode of sorption of cadmium to sediments is important in determining its disposition to remobilize. Cadmium associated with carbonate minerals, precipitated as stable solid compounds or co-precipitated with hydrous iron oxides, is less likely to be mobilized by resuspension of sediments or biological activity. Cadmium that is adsorbed to mineral surfaces such as clay, or to organic materials, is more easily bioaccumulated or released in the dissolved state when the sediment is disturbed (EPA 1979). Cadmium may redissolve from sediments under varying ambient conditions of pH, salinity, and redox potential (DOI 1985; EPA 1979; Feijtel et al. 1988; Muntau and Baudo 1992). Cadmium is not known to form volatile compounds in the aquatic environment, so partitioning from water to the atmosphere does not occur (EPA 1979).

6. POTENTIAL FOR HUMAN EXPOSURE

Debusk et al. (1996) studied the retention and compartmentalization of lead and cadmium in wetland microcosms. Differences between measured concentrations in inflow and outflow samples indicated that approximately half of the added cadmium was retained in the wetland microcosms. Experiments showed that nearly all trace metals were present in the sediments as sulfides, limiting their bioavailability and toxicity. The results of their analyses and a lack of noticeable biological effects suggested that in wetlands containing organic sediments, the sediment chemistry dominates cycling of the trace metals.

In soils, pH, oxidation-reduction reactions, and formation of complexes are important factors affecting the mobility of cadmium (Bermond and Bourgeois 1992; Herrero and Martin 1993). Cadmium can participate in exchange reactions on the negatively charged surface of clay minerals. In acid soils, the reaction is reversible. However, adsorption increases with pH and may become irreversible (Herrero and Martin 1993). Cadmium also may precipitate as insoluble cadmium compounds, or form complexes or chelates by interaction with organic matter. Available data suggest that organic matter is more effective than inorganic constituents in keeping cadmium unavailable (McBride 1995). Examples of cadmium compounds found in soil are $\text{Cd}_3(\text{PO}_4)_2$, CdCO_3 , and $\text{Cd}(\text{OH})_2$ (Herrero and Martin 1993). These compounds are formed as the pH rises. It has been found that about 90% of cadmium in soils remains in the top 15 cm (Anonymous 1994).

The mobility and plant availability of cadmium in wetland soils are substantially different from upland soils. Cadmium tends to be retained more strongly in wetland soils and is more available to plants under upland conditions (Gambrell 1994). Debusk et al. (1996) compared heavy metal uptake by cattails and duckweed wetland microcosms and found that duckweed, on a whole-plant basis, accumulates cadmium more effectively than cattail does. The potential cadmium removal rate for duckweed is 2–4 mg $\text{Cd}/\text{m}^2/\text{day}$.

Cadmium in soils may leach into water, especially under acidic conditions (Elinder 1985a; EPA 1979). Roy et al. (1993) demonstrated that chlorine complexation in the leachate of ash from a municipal solid waste incinerator can result in a decrease in cadmium sorption by two common clays, kaolinite and illite. They also found that cationic competitive sorption enhances mobility in soils. Cadmium-containing soil particles may also be entrained into the air or eroded into water, resulting in dispersion of cadmium into these media (EPA 1985a). Contamination of soil by cadmium is of concern because the cadmium is taken up efficiently by plants and, therefore, enters the food chain for humans and other animals. A low soil pH, which is becoming prevalent in many areas of the world due to acid rain, increases the uptake of cadmium by plants (Elinder 1992).

6. POTENTIAL FOR HUMAN EXPOSURE

Aquatic and terrestrial organisms bioaccumulate cadmium (Handy 1992a, 1992b; Kuroshima 1992; Naqvi and Howell 1993; Roseman et al. 1994; Suresh et al. 1993). Cadmium concentrates in freshwater and marine animals to concentrations hundreds to thousands of times higher than in the water (EPA 1979). Reported bioconcentration factors (BCFs) range from <200 to 18,000 for invertebrates (van Hattum et al. 1989), from 3 to 4,190 for fresh water aquatic organisms (ASTER 1995), and from 5 to 3,160 for saltwater aquatic organisms (ASTER 1994). Bioconcentration in fish depends on the pH and the humus content of the water (John et al. 1987). Because of their high ability to accumulate metals, some aquatic plants have been suggested for use in pollution control. For example, it has been suggested that the rapidly-growing water hyacinth (*Eichhornia crassipes*) could be used to remove cadmium from domestic and industrial effluents (Ding et al. 1994; Muntau and Baudo 1992).

The data indicate that cadmium bioaccumulates in all levels of the food chain. Cadmium accumulation has been reported in grasses and food crops, and in earthworms, poultry, cattle, horses, and wildlife (Alloway et al. 1990; Beyer et al. 1987; Gochfeld and Burger 1982; Kalac et al. 1996; Munshower 1977; Ornes and Sajwan 1993; Rutzke et al. 1993; Sileo and Beyer 1985; Vos et al. 1990). The metal burden of a crop depends on uptake by the root system, direct foliar uptake and translocation within the plant, and surface deposition of particulate matter (Nwosu et al. 1995). In general, cadmium accumulates in the leaves of plants and, therefore, is more of a risk in leafy vegetables grown in contaminated soil than in seed or root crops (Alloway et al. 1990). He and Singh (1994) report that, for plants grown in the same soil, accumulation of cadmium decreased in this order: leafy vegetables, root vegetables, and grain crops. Alloway et al. (1990) also demonstrated that uptake of cadmium decreased in this order: lettuces, cabbages, radishes, and carrots. Nwosu et al. (1995) investigated the uptake of cadmium and lead in lettuce and radish grown in loam soil spiked with known mixtures of CdCl_2 and $\text{Pb}(\text{NO}_3)_2$. They found that the mean uptake of cadmium by lettuce and radish increased as the concentrations of cadmium and lead in the soil increased. Their results supported previous findings that cadmium is absorbed by passive diffusion and translocated freely in the soil. The observed decline in cadmium uptake by lettuce at 400 mg/kg could be attributed to saturation of the active binding sites on the plant root system or by early toxicological responses of the plant root. The study also supported earlier findings that radish did not accumulate as much cadmium as lettuce.

Some studies have concluded that soil pH is the major factor influencing plant uptake of cadmium from soils (Smith 1994). Amending soil with lime raises the pH, increasing cadmium adsorption to the soil and reducing bioavailability (He and Singh 1994; Thornton 1992). One study found that in peeled potato

6. POTENTIAL FOR HUMAN EXPOSURE

tubers, potato peelings, oat straw, and ryegrass, cadmium concentrations generally decreased as simple linear functions of increasing soil pH over the range of pH values measured (pH 3.9–7.6) (Smith 1994). Soil type also affects uptake of cadmium by plants. For soils with the same total cadmium content, cadmium has been found to be more soluble and more plant-available in sandy soil than in clay soil (He and Singh 1994). Similarly, cadmium mobility and bioavailability are higher in noncalcareous than in calcareous soils (Thornton 1992). Oxidation-reduction potential may also have a large effect on soil-to-plant cadmium transport. The absorption of cadmium paddy rice is significantly affected by the oxidation-reduction potential of the soil. The oxidation-reduction potential of rice paddy soils shifts drastically compared to upland soils due to submerging and draining techniques. Cadmium to rice ratios (cadmium concentration in brown rice/cadmium concentration in soil) were the smallest when the rice was grown under submerged conditions during the whole growth period. The ratios were the largest when the soil (coarse Toyama soil) was drained after the tillering stage. This is due to changes in cadmium solubility. Under flooded conditions, cadmium sulfide formation increases, and thus, cadmium solubility decreases (Iimura 1981).

Since cadmium accumulates largely in the liver and kidneys of vertebrates and not in the muscle tissue (Harrison and Klaverkamp 1990; Sileo and Beyer 1985; Vos et al. 1990), and intestinal absorption of cadmium is low, biomagnification through the food chain may not be significant (Sprague 1986). In a study of marine organisms from the Tyrrhenian Sea, no evidence of cadmium biomagnification was found along pelagic or benthic food webs (Bargagli 1993). Although some data indicate increased cadmium concentrations in animals at the top of the food chain, comparisons among animals at different trophic levels are difficult, and the data available on biomagnification are not conclusive (Beyer 1986; Gochfeld and Burger 1982). Nevertheless, uptake of cadmium from soil by feed crops may result in high levels of cadmium in beef and poultry (especially in the liver and kidneys). This accumulation of cadmium in the food chain has important implications for human exposure to cadmium, whether or not significant biomagnification occurs.

Boularbah et al. (1992) isolated six cadmium-resistant bacterial strains from a soil receiving dredged sediments and containing 50 mg Cd/kg. The isolates tolerated higher cadmium concentrations than the control strain and accumulated cadmium at concentrations ranging from 0 to 100 mg/L. One of the isolates, *Bacillus brevis*, was found to be the most resistant to cadmium, with the ability to accumulate up to 70 mg Cd/g of cells dry weight, and may have some use in reclamation of metal-contaminated soils.

6. POTENTIAL FOR HUMAN EXPOSURE

6.3.2 Transformation and Degradation**6.3.2.1 Air**

Little information is available on the atmospheric reaction of cadmium (EPA 1980d). The common cadmium compounds found in air (oxide, sulfate, chloride) are stable and not subject to photochemical reactions (EPA 1980d). Cadmium sulfide may photolyze to cadmium sulfate in aqueous aerosols (Konig et al. 1992). Transformation of cadmium among types of compounds in the atmosphere is mainly by dissolution in water or dilute acids (EPA 1980d).

6.3.2.2 Water

In fresh water, cadmium is present primarily as the cadmium(+2) ion and $\text{Cd}(\text{OH})_2$ and CdCO_3 complexes, although at high concentrations of organic material, more than half may occur in organic complexes (McComish and Ong 1988). Some cadmium compounds, such as cadmium sulfide, cadmium carbonate, and cadmium oxide, are practically insoluble in water. However, water-insoluble compounds can be changed to water-soluble salts by interaction with acids or light and oxygen. For example, aqueous suspensions of cadmium sulfide can gradually photooxidize to soluble cadmium (IARC 1993). Cadmium complexation with chloride ion increases with salinity until, in normal seawater, cadmium exists almost entirely as chloride species (CdCl^+ , CdCl_2 , CdCl_3^-) with a minor portion as Cd^{2+} . In reducing environments, cadmium precipitates as cadmium sulfide in the presence of sulfide ions (McComish and Ong 1988). Photolysis is not an important mechanism in the aquatic fate of cadmium compounds (EPA 1983c), nor is biological methylation likely to occur (EPA 1979).

6.3.2.3 Sediment and Soil

Transformation processes for cadmium in soil are mediated by sorption from and desorption to water, and include precipitation, dissolution, complexation, and ion exchange (McComish and Ong 1988). Important factors affecting transformation in soil include the cation exchange capacity, pH, and content of clay minerals, carbonate minerals, oxides, organic matter, and oxygen (McComish and Ong 1988).

6.4 LEVELS MONITORED OR ESTIMATED IN THE ENVIRONMENT

Reliable evaluation of the potential for human exposure to cadmium depends in part on the reliability of supporting analytical data from environmental samples and biological specimens. Concentrations of cadmium in unpolluted atmospheres and in pristine surface waters are often so low as to be near the limits

6. POTENTIAL FOR HUMAN EXPOSURE

of current analytical methods. In reviewing data on cadmium levels monitored or estimated in the environment, it should also be noted that the amount of chemical identified analytically is not necessarily equivalent to the amount that is bioavailable. The analytical methods available for monitoring cadmium in a variety of environmental media are detailed in Chapter 7.

6.4.1 Air

Cadmium levels in ambient air generally range from 0.1 to 5 ng/m³ in rural areas, 2–15 ng/m³ in urban areas, and 15–150 ng/m³ in industrialized areas. Remote areas can contain lower levels of cadmium (Morrow 2001). Cadmium can undergo long-range atmospheric transport and deposition causing cadmium contamination in areas with no local cadmium inputs. Smoking can greatly affect indoor air concentrations of cadmium. In nonsmoking environments, there is little difference between indoor and outdoor air quality (Morrow 2001). Monitoring studies conducted for EPA's 2006 Final Report for the Urban Air Toxics Monitoring Program detected cadmium in ambient air at several monitoring sites throughout the United States. At all detection sites in Bountiful, Utah; Northbrook, Illinois; Austin, Texas; St. Louis, Missouri; Indianapolis, Indiana; and Birmingham, Alabama average daily cadmium levels in ambient air were <0.01 µg/m³. In Bountiful, Utah average daily cadmium levels were reported as 0.0008 µg/m³ (EPA 2007).

Emission rates of cadmium from solid waste incinerators have been found to range from 20 to 2,000 µg/m³ from the stacks of traditional incinerators and from 10 to 40 µg/m³ from advanced incinerators. Advances in pollution control and increased government regulations have resulted in decreased cadmium emissions to the environment (EPA 1990a; Herron 2003; Morrow 2001; Schulte-Schrepping and Piscator 2002). Although there may be an increase in fossil fuel combustion and waste incineration, it does not appear likely that overall cadmium emissions to air will increase substantially in the United States.

Cadmium levels in aerosols over Russian Arctic seas were measured in order to understand the magnitude of long-range atmospheric deposition. Ten-year average monthly mean concentrations ranged from 0.002 to 0.080 ng/m³ in Franz Josef Land and from 0.0026 to 0.048 ng/m³ in Sevemaya Zemlya. The highest concentrations were reported in the spring season and the lowest concentrations reported in the autumn for both sampling sites. During the winter and spring months, it was estimated that >50% of the average air pollutant concentrations in the Russian Arctic are due to atmospheric pollution. The

6. POTENTIAL FOR HUMAN EXPOSURE

anthropogenic sources of cadmium to the Russian Arctic are the industrial areas of Northern Europe, Kola Peninsula, and the Urals and Norilsk regions (Shevchenko et al. 2003).

Atmospheric concentrations of cadmium are generally highest in the vicinity of cadmium-emitting industries such as smelters, municipal incinerators, or fossil fuel combustion facilities (Elinder 1985a; Pirrone et al. 1996). The mean annual concentration of airborne cadmium in an area about 1 km from a zinc smelter in Colorado was $0.023 \mu\text{g}/\text{m}^3$ ($2.3 \times 10^{-5} \text{ mg}/\text{m}^3$) (IARC 1993). Sweet et al. (1993) conducted a study of airborne inhalable particulate matter (PM-10) over a 2-year period in two urban/industrial areas (southeast Chicago and East St. Louis) and one rural area in Illinois. There was a significant difference between the cadmium levels in the urban areas and the cadmium levels in the rural area. Cadmium concentrations in the East St. Louis area were 5–10 times higher, with a range of <4 to $115 \text{ ng}/\text{m}^3$ (average $15[24] \text{ ng}/\text{m}^3$) for fine particles and a range of <4 – $97 \text{ ng}/\text{m}^3$ (average $10[18] \text{ ng}/\text{m}^3$) for coarse particles. In the Kikinda region of Serbia and Montenegro, where metal processing and construction industries are located, a mean annual atmospheric deposit of $36.0 \mu\text{g}/\text{m}^2$ per day was reported in 1995. A period of decreased industrial production, which decreased atmospheric cadmium deposits by 93%, resulted in 17% cadmium reduction in cattle feed and 13% in milk (Vidovic et al. 2005). Moss studies conducted by Hasselbach et al. (2005) in the area of the Red Dog Mine in Alaska reported cadmium levels $>24 \text{ mg}/\text{kg}$ dry weight in moss adjacent to the ore haul road. Ore dust containing heavy metals escapes from the ore trucks on the haul road and can be deposited in the nearby area (Hasselbach et al. 2005).

Annual average concentrations of atmospheric cadmium over three Great Lakes reflect the influence of industrialization and urbanization; Lake Erie's levels of $0.6 \text{ ng}/\text{m}^3$ were higher than fine particle concentrations of $0.2 \text{ ng}/\text{m}^3$ over Lake Michigan and $<0.2 \text{ ng}/\text{m}^3$ over Lake Superior (Sweet et al. 1998). In the Lake Michigan Urban Air Toxics Study of dry deposition of metals, the flux of cadmium on the south side of Chicago was reported at about $0.01 \text{ mg}/\text{m}^2/\text{day}$ and levels in rural Michigan and over Lake Michigan were far lower (Holsen et al. 1993).

6.4.2 Water

The average level of cadmium in ocean water has been reported between <5 and $110 \text{ ng}/\text{L}$, with higher levels reported near coastal areas and in marine phosphates and phosphorites (Morrow 2001).

6. POTENTIAL FOR HUMAN EXPOSURE

Thornton (1992) reports that waters from the vicinity of cadmium-bearing mineral deposits may have cadmium concentrations of $\geq 1,000$ $\mu\text{g/L}$. The cadmium concentration of natural surface water and groundwater is usually < 1 $\mu\text{g/L}$ (Elinder 1985a, 1992). EPA requires water suppliers to limit the cadmium concentration in drinking water to < 5 $\mu\text{g/L}$ (EPA 2006a).

Groundwater in New Jersey has an estimated median level of 1 $\mu\text{g Cd/L}$ with a high level of 405 $\mu\text{g/L}$. In a survey of groundwater surrounding waste sites, a concentration of 6,000 $\mu\text{g Cd/L}$ was found (NTP 1994). The National Urban Runoff Program measured cadmium concentrations in urban storm water runoff; concentrations ranged from 0.1 to 14 $\mu\text{g/L}$ in 55% of samples that were positive for cadmium (Cole et al. 1984). Cadmium in highway run-off has been detected at levels of 0.0–0.06 mg/L (0.0–60 $\mu\text{g/L}$).

In the estuarine portion of the Hudson River, more cadmium was released from agricultural and urban run-off than from industrial and municipal sewage treatment plants (Muntau and Baudo 1992). In an urban environment, there are also multiple sources of cadmium to waste water, based on an urban waste water study conducted in the United Kingdom. Cadmium was detected in the waste water originating from industrial, commercial, and private sectors, with the highest average cadmium concentration detected in the foul water of new (< 5 years old) private housing (0.375 $\mu\text{g/L}$) (Rule et al. 2006). Cadmium was detected in the contaminated groundwater plume near in the Moon Creek watershed in the Couer D'Alene Mining District of Idaho at concentrations of ≤ 0.077 mg/L . The cadmium was transported to the creek with the plume where it was subsequently diluted (Paulson 1997). In the Spring River Basin of Kansas, Missouri, and Oklahoma, part of the Tri-State Mining District, cadmium was detected in surface waters at concentrations ranging from < 1.0 to 24 $\mu\text{g/L}$ (peak flow) and from < 1.0 to 75.0 $\mu\text{g/L}$ (base flow). It was detected in the sediment of the sampling sites at concentrations ranging from 0.62 to 300 $\mu\text{g/g}$ dry weight in the < 250 μm sediment fraction and from 0.89 to 180 $\mu\text{g/g}$ dry weight in the < 63 μm fraction (Angelo et al. 2007).

6.4.3 Sediment and Soil

Cadmium concentrations in soils not contaminated by anthropogenic sources range from 0.06 to 1.1 mg/kg , with a minimum of 0.01 mg/kg and a maximum of 2.7 mg/kg (Alloway and Steinnes 1999). Cadmium content in marine sediments ranges from 0.1 to 1.0 $\mu\text{g/g}$ (ppm) in the Atlantic and Pacific oceans (Thornton 1992). Average cadmium concentration in agricultural soils of remote locations was reported as 0.27 mg/kg (Holmgren et al. 1993). Soils with parent materials such as black shale (cadmium

6. POTENTIAL FOR HUMAN EXPOSURE

content up to 24 mg/kg) may have higher concentrations of natural cadmium. Since the U.S. mandatory limit of cadmium in sewage sludge is <20 mg/kg, soils receiving sewage sludge should not have heightened cadmium levels (Alloway and Steinnes 1999). Topsoil concentrations are often more than twice as high as subsoil levels as the result of atmospheric fallout and contamination (Pierce et al. 1982). Cadmium will partition mostly to soil and sediment when released to the environment. Atmospheric deposition is a major source of surface soil contamination, which allows cadmium to be introduced into the food supply (Alloway and Steinnes 1999; Morrow 2001).

Markedly elevated levels may occur in topsoils near sources of contamination. Moss studies conducted by Hasselbach et al. (2005) in the area of the Red Dog Mine in Alaska reported cadmium levels >24 mg/kg dry weight in moss (n=151), as a measure atmospheric deposition onto soil surfaces, within 10 m of the ore haul road. Ore dust containing heavy metals escapes from the ore trucks during loading and unloading at the mine and port site settles on the surfaces of the trucks, which blow off the trucks during transport on the haul road and deposited in the nearby area. The mean cadmium concentrations in moss and subsurface soil throughout the entire study were 1.86 and 0.27 mg/kg dry weight, respectively. Cadmium concentrations in moss and subsurface soil were 0.08–24.30 and 0.07–0.75 mg/kg dry weight. There did not appear to be a connection between the elevated subsurface cadmium levels and the local geochemistry. Geospatial analysis showed that areas as far as 12 km north of the haul road may be affected by mining emission depositions (Hasselbach et al. 2005). In the vicinity of a smelter in Helena, Montana, average soil values were 72 ppm within 1 km and 1.4 ppm between 18 and 60 km (EPA 1981a). Total cadmium concentrations in soil samples taken from a Superfund site in southeast Kansas ranged from 15 to 86 mg/kg (ppm). In the same study, soil samples were extracted with diethylenetriamine-pentaacetic acid (DPTA) to approximate the plant-available metal concentrations. Extractable cadmium concentrations ranged from 0.6 to 10 mg/kg (ppm) (Abdel-Saheb et al. 1994). Soil cadmium levels in five Minnesota cities were highest in areas with the most vehicular traffic (>2 ppm in about 10% of inner-city samples) and also showed a pattern consistent with past deposition from a sewage-sludge incinerator (Mielke et al. 1991). Cadmium levels >750 mg/kg have been found in sites polluted by nonferrous metal mining and smelting have been reported (Alloway and Steinnes 1999).

In the Spring River Basin of Kansas, Missouri, and Oklahoma, part of the Tri-State Mining District, cadmium was detected in surface waters at concentrations of <1.0–24 µg/L (peak flow) and <1.0–75.0 µg/L (base flow). Cadmium was detected in the sediment of the sampling sites at concentrations ranging from 0.62 to 300 µg/g dry weight in the <250 µm sediment fraction and from 0.89 to 180 µg/g dry weight in the <63 µm fraction (Angelo et al. 2007). A study conducted in 1999 at the Patroon Creek

6. POTENTIAL FOR HUMAN EXPOSURE

Reservoir in Albany County, New York sampled sediment cores for heavy metals, including cadmium. The watershed includes two industrial sites: one in operation from 1955 to present and the other operating from 1958 to 1984. Sediment samples in the interval of 0–1.68 m showed an average cadmium concentration of 1.69 mg/kg. This concentration is comparable to other stream and reservoir sediments impacted by industrial pollution (Arnason and Fletcher 2003). Sediments of the Sawmill River in Yonkers, New York contained the highest cadmium levels (6.9 mg/kg) in the Hudson River Basin during a sampling study conducted between 1992 and 1995 (USGS 1998b).

Surficial sediments collected from 18 locations in three major tributaries to Newark Bay, New Jersey, had a mean cadmium concentration of 10 ± 6 mg/kg (ppm) dry weight (Bonnievie et al. 1994). The highest cadmium concentrations were found in the Ironbound section of the Passaic River, a heavily industrialized area (29 mg/kg and 14 mg/kg), and in the Arthur Kill on the northwest side of Prall's Island (15 mg/kg). An investigation of metals distribution in sediments along the Hudson River estuary revealed that cadmium concentrations in suspension were higher than in the bottom sediments by a factor of 30 (Gibbs 1994).

Soils derived from dredged material in confined disposal facilities in the Great Lakes Region had cadmium concentrations (dry weight) of <1.9–32 ppm (Beyer and Stafford 1993). In an analytical survey of sewage sludges from 16 large cities in the United States, cadmium concentrations ranged from 2.72 to 242 ppm (dry weight). Besides the sample with a cadmium concentration of 242 ppm, all other sludges had cadmium contents ≤ 14.7 ppm (Gutenmann et al. 1994).

6.4.4 Other Environmental Media

Cadmium levels in food can vary greatly depending on the type of food, agricultural and cultivating practices, and amount atmospheric deposition and other anthropogenic contamination. In general, leafy vegetables, such as lettuce and spinach, and staples, such as potatoes and grains, contain relatively high values of cadmium. Peanuts, soybeans, and sunflower seeds have naturally high levels of cadmium. Meat and fish contain lower amounts of cadmium, with the exception of animal organ meats, such as kidney and liver, as these organs concentrate cadmium (Morrow 2001).

As part of the U.S. Food and Drug Administration (FDA) Total Diet Study, average concentrations of cadmium in 14 food groups were analyzed from samples collected in 56 American cities. Cadmium was found in nearly all samples at varying concentrations. In general, the eggs, milk and cheese, condiments

6. POTENTIAL FOR HUMAN EXPOSURE

and sweeteners, beverages, and fats and dressings groups contained low concentrations of cadmium (≤ 0.004 mg/kg) (FDA 2010). Food items that contained high levels of cadmium were dry roasted peanuts (0.054 mg/kg), shredded wheat cereal (0.050 mg/kg), boiled spinach (0.124 mg/kg), iceberg lettuce (0.051 mg/kg), leaf lettuce (0.064 mg/kg), and potato chips (0.057 mg/kg) (FDA 2010). [Table 6-3](#) summarizes the data from this study.

Watanabe et al. (1996) measured the cadmium content in rice samples from various areas in the world during the period from 1990 to 1995. Twenty-nine samples collected in the United States had a geometric mean of 7.43 ng Cd/g, with a standard deviation of 2.11. Shellfish, liver, and kidney meats have higher concentrations than other fish or meat (up to 1 ppm) (Elinder 1985a; IARC 1993; Schmitt and Brumbaugh 1990). Particularly high concentrations of cadmium of 2–30 mg/kg (ppm) fresh weight have been found in the edible brown meat of marine shellfish (Elinder 1992). Cadmium concentrations up to 8 $\mu\text{g/g}$ in oysters and 3 $\mu\text{g/g}$ in salmon flesh have been reported (IARC 1993). Sprague (1986) reviewed tissue concentrations of cadmium for marine mollusks and crustaceans. They found that drills, a type of sea snail, were higher in cadmium (average, 26 $\mu\text{g/g}$ dry weight) than almost all other mollusks, although scallops and whelks also tended to be high. Oysters from polluted areas averaged 18 $\mu\text{g/g}$ dry weight, which was significantly higher than oysters from clean areas (average concentration 1.4 $\mu\text{g/g}$ dry weight). Clams were relatively low in cadmium (average, 0.5–1.0 $\mu\text{g/g}$ dry weight). The average concentration of cadmium in clams from polluted areas was only 2.7 $\mu\text{g/g}$ dry weight, but this was significantly higher than levels in clams from clean areas. In Fiscal Year (FY) 1985/1986, the FDA conducted a survey of cadmium, lead, and other elements in fresh clams and oysters collected from U.S. coastal areas used for shellfish production (Capar and Yess 1996). Average cadmium levels (wet weight) were 0.09 ± 0.06 mg/kg (ppm) ($n=75$) in hardshell clams, 0.05 ± 0.04 mg/kg ($n=59$) in softshell clams, 0.51 ± 0.31 mg/kg ($n=104$) in Eastern oysters, and 1.1 ± 0.6 mg/kg ($n=40$) in Pacific oysters. In FY91, FDA analyzed 5 samples of domestic clams and 24 samples of domestic oysters (collected from both coasts) for cadmium and found average concentrations of 0.06 and 0.62 mg/kg, respectively (Capar and Yess 1996). Although no conclusions can be drawn in light of the small numbers of FY91 samples, these results do not appear to be appreciably different from those of the FY85/86 survey..

Cadmium is accumulated mainly in the hepatopancreas (digestive gland) of the crab, and cadmium levels as high as 30–50 ppm have been detected in this edible part of the animal. Cadmium levels as high as 10 ppm also have been measured in some species of wild-growing edible mushrooms (Lind et al. 1995). Lind et al. (1995) conducted a feeding study in mice to determine the bioavailability of cadmium from crab hepatopancreas and mushroom in relation to organic cadmium. The cadmium accumulation in the

6. POTENTIAL FOR HUMAN EXPOSURE

Table 6-3. Mean Concentrations of Cadmium for FDA's Total Diet Study Market Baskets 2006-1 through 2008-4

Food product	Mean concentration range (mg/kg)
Milk and cheese	Not detected–0.002
Eggs	Not detected–0.0003
Meat, poultry, and fish	Not detected–0.069
Legumes and nuts	0.001–0.054
Grain products	0.0001–0.028
Fruit	Not detected–0.015
Vegetables	0.001–0.124
Mixed dishes and meals	0.003–0.021
Desserts	Not detected–0.028
Condiments and sweeteners	0.001–0.0002
Fats and dressings	Not detected–0.004
Beverages	Not detected–0.001
Infant and junior foods	0.0002–0.026

Source: FDA 2010

6. POTENTIAL FOR HUMAN EXPOSURE

liver and kidney of the mice was used as an estimate of the intestinal absorption. The group that was fed crab accumulated less cadmium in the liver and kidney than the groups fed mushrooms or inorganic cadmium salt. They concluded from the results of the study that cadmium from boiled crab has a lower bioavailability for absorption in the gastrointestinal tract of mice than inorganic cadmium and cadmium from dried mushrooms. Almost all (99%) of the cadmium in the boiled crab hepatopancreas was associated with insoluble ligands, probably denatured protein. In fresh crab hepatopancreas, most of the cadmium is in a soluble form bound to metallothionein (Lind et al. 1995).

Significant concentrations of cadmium have been observed in fish living in stormwater ponds in Florida, especially in the redear sunfish, a bottom feeder (Campbell 1994). The mean cadmium concentration in redear sunfish living in stormwater ponds was 1.64 mg/kg wet weight compared to 0.198 mg/kg for redear sunfish living in control ponds. Similarly, the mean cadmium concentration in largemouth bass living in stormwater ponds was 3.16 mg/kg wet weight compared to 0.241 mg/kg for largemouth bass living in control ponds. Red drum, flounder, and seatrout collected from South Carolina estuaries during the period 1990–1993 had consistently low cadmium levels throughout the sampling area and with respect to species (Mathews 1994). The mean concentration for all fillets and whole fish was 86.2 ppb wet weight, with 70.7% (n=164) of the samples having <25 ppb.

Cadmium and other heavy metals were detected in several of the freshwater invertebrates and fish of two Maryland streams. Due to their remote location and lack of source inputs, it is believed that the cadmium contamination was a result of long-range atmospheric deposition. Samples were taken from the Herrington Creek tributary (HCRT) and Blacklick Run (BLK) during October 1997, April 1998, and July 1998. Cadmium concentrations in the trout of BLK ranged from about 37 to 90 ng/g wet, with the older specimens having the higher cadmium concentrations. Cadmium concentrations in crayfish ranged from about 40 to 160 ng/g wet in BLK, with the younger specimens containing the highest levels of cadmium. Crayfish in HCRT ranged from 45 to 155 ng/g, with the highest levels in the middle age group. In crayfish, cadmium strongly accumulates in the gills, while the kidney accumulates cadmium in trout (Mason et al. 2000).

Cadmium concentrations in the fish of the mining-contaminated waters of Oklahoma were reported by Brumbaugh et al. (2005). This area was part of the Tri-State Mining District that was extensively mined for lead and zinc from the mid-1800s to the 1950s, and contains nonremediated sites. Blood and carcass cadmium concentrations differed between species and sites, but were generally greatest in carp. Carcass cadmium in catfish were relatively low, with <0.1 µg/g dry weight in 34 of 36 samples.

6. POTENTIAL FOR HUMAN EXPOSURE

Cadmium concentrations of ≥ 0.5 ppm have been found in rice grown in cadmium-polluted areas of Japan (Nogawa et al. 1989) and China (Shiwen et al. 1990). Tobacco also concentrates cadmium from the soil, and cadmium content of cigarettes typically ranges from 1 to 2 $\mu\text{g}/\text{cigarette}$ (Elinder 1985a, 1992).

Some food crops, including confectionery sunflowers, have a propensity to take up cadmium from the soil in which they are grown and deposit it in the kernels. In a study to determine the cadmium burden of persons who report regular consumption of sunflower kernels, Reeves and Vanderpool (1997) analyzed 19 different lots of sunflower kernels from the 1995 crop grown in the northern Great Plains region of North Dakota and Minnesota. They found a range of 0.33–0.67 $\mu\text{g Cd/g}$, with a mean \pm standard deviation of 0.48 ± 0.11 $\mu\text{g/g}$ fresh weight. The study showed that high intakes of sunflower kernels increased the intake of cadmium. However, the amount of cadmium in whole blood or in red blood cells was not affected by cadmium intake. The authors pointed out that an increased intake of sunflowers will increase not only the cadmium intake, but also the intake of copper and phytate. In turn, this could reduce the availability of cadmium from this food source.

DOI (1985) examined the concentrations of cadmium in a variety of aquatic and terrestrial flora and fauna and identified six trends: (1) in general, marine biota contained significantly higher cadmium residues than their freshwater or terrestrial counterparts; (2) cadmium tends to concentrate in the viscera of vertebrates, especially in the liver and kidneys; (3) cadmium concentrations are higher in older organisms than in younger ones, especially in carnivores and marine vertebrates; (4) higher concentrations for individuals of a single species collected at various locations are almost always associated with proximity to industrial/urban areas or point-source discharges of cadmium-containing wastes; (5) background levels of cadmium in crops and other plants are generally < 1.0 mg/kg (ppm); and (6) cadmium concentrations in biota are dependent upon the species analyzed, the season of collection, ambient cadmium levels, and the sex of the organism.

During a study monitoring cadmium levels in 331 cigarette packs from over 20 areas around the world it was found that the mean cadmium level per cigarette was 1.15 $\mu\text{g}/\text{cigarette} \pm 0.43$ (AM \pm ASD) or 1.06 $\mu\text{g}/\text{cigarette} \pm 1.539$ (geometric mean [GM] \pm geometric standard deviation[GSD]). Cigarettes from Mexico had the highest mean level of cadmium with an AM \pm ASD of 2.03 $\mu\text{g}/\text{cigarette} \pm 0.33$ or a GM \pm GSD of 2.00 $\mu\text{g}/\text{cigarette} \pm 1.190$. Cigarettes from India had the lowest mean levels of cadmium with an AM \pm ASD of 0.35 $\mu\text{g}/\text{cigarette} \pm 0.09$ or a GM \pm GSD of 0.34 $\mu\text{g}/\text{cigarette} \pm 1.284$. The arithmetic

6. POTENTIAL FOR HUMAN EXPOSURE

mean for the United States was 1.07 $\mu\text{g}/\text{cigarette} \pm 0.11$ and the $\text{GM} \pm \text{GSD}$ was 1.06 $\mu\text{g}/\text{cigarette} \pm 1.115$ (Watanabe et al. 1987).

The cadmium content of coals varies widely; concentrations of 0.01–180 $\mu\text{g}/\text{g}$ (ppm) have been reported for the United States (Thornton 1992; Wilber et al. 1992).

6.5 GENERAL POPULATION AND OCCUPATIONAL EXPOSURE

The general population may be exposed to cadmium through ingestion of food and drinking water, inhalation of particulates from ambient air or tobacco smoke, or ingestion of contaminated soil or dust. For nonsmokers, food is the major source of cadmium exposure (NTP 2005). Inhalation of cigarette smoke is the major source of cadmium exposure for smokers (CDC 2005). Cadmium is introduced to the food chain through agricultural soils, which may naturally contain cadmium, or from anthropogenic sources such as atmospheric deposition or direct application methods such as phosphate fertilizer application and municipal waste composting (Alloway and Steinnes 1999; Morrow 2001). Cadmium-plated utensils and galvanized equipment used in food processing and preparation; enamel and pottery glazes with cadmium-based pigments; and stabilizers used in food-contact plastics are also sources of food contamination (Galal-Gorchev 1993). Cadmium levels in soils are not a direct indicator of the level of cadmium in the food supply, with the exception of extreme contamination, as other factors such as the type of crop and farming methods are important (Morrow 2001).

Based on food intake rates and food-cadmium concentrations, the estimated geometric mean daily intake of cadmium for the U.S. population is 18.9 $\mu\text{g}/\text{day}$, down from an estimated 30 $\mu\text{g}/\text{day}$ in the 1980s (Choudhury et al. 2001; Gartrell et al. 1986). Based on the mean cadmium daily intakes for males and females aged 6–60 years reported by Choudhury et al. (2001), age-weighted mean cadmium intakes of 0.35 $\mu\text{g}/\text{kg}/\text{day}$ for males and 0.30 $\mu\text{g}/\text{kg}/\text{day}$ for females were calculated for U.S. nonsmokers.

In the Fourth National Report on Human Exposures to Environmental Chemicals reported by the CDC (2011) results from the National Health and Nutrition Examination Survey (NHANES) 1999–2008 were reported. Cadmium levels in blood (see [Table 6-4](#)), urine (creatinine corrected) (see [Table 6-5](#)), and urine (see [Table 6-6](#)) was evaluated for a variety of age groups and ethnicities. Blood cadmium reflects both recent and cumulative exposures and urinary cadmium reflects cadmium exposure and the concentration of cadmium in the kidneys.

6. POTENTIAL FOR HUMAN EXPOSURE

Table 6-4. Geometric Mean and Selected Percentile Blood Concentrations (µg/L) of Cadmium in the U.S. Population from 1999 to 2008

Group	Survey years	Geometric mean ^a (95% CI)	Selected percentiles (95% CI)				Sample size	
			50 th	75 th	90 th	95 th		
Total, age 1 and older	1999–2000	0.412 (0.378–0.449)	0.300 (0.300–0.400)	0.600 (0.500–0.600)	1.00 (0.900–1.00)	1.30 (1.20–1.40)	7,970	
	2001–2002	Not calculated	0.300 (<LOD–0.300)	0.400 (0.400–0.500)	0.900 (0.900–1.10)	1.30 (1.20–1.60)	8,945,	
	2003–2004	0.304 (0.289–0.320)	0.300 (0.300–0.300)	0.500 (0.500–0.600)	1.10 (1.00–1.20)	1.60 (1.50–1.60)	8,372	
	2005–2006	0.310 (0.294–0.327)	0.270 (0.250–0.280)	0.501 (0.460–0.560)	1.02 (0.910–1.13)	1.53 (1.34–1.75)	8,407	
	2007–2008	0.315 (0.300–0.331)	0.270 (0.260–0.280)	0.500 (0.460–0.560)	1.00 (0.900–1.13)	1.51 (1.30–1.77)	8,266	
Age group	1–5 Years	1999–2000	Not calculated	<LOD	0.300 (<LOD–0.300)	0.400 (0.300–0.400)	0.400 (0.300–0.400)	723
		2001–2002	Not calculated	<LOD	<LOD	<LOD	0.300 (<LOD–0.300)	898
		2003–2004	Not calculated	<LOD	<LOD	0.200 (0.200–0.300)	0.200 (0.200–0.400)	910
		2005–2006	Not calculated	<LOD	<LOD	<LOD	0.230 (0.210–0.250)	968
		2007–2008	Not calculated	<LOD	<LOD	0.210 (<LOD–0.230)	0.240 (0.220–0.260)	817
	6–11 Years	1999–2000	Not calculated	<LOD	0.300 (<LOD–0.300)	0.400 (0.300–0.400)	0.400 (0.400–0.500)	905
		2001–2002	Not calculated	<LOD	<LOD	<LOD	0.400 (0.300–0.400)	1,044
		2003–2004	Not calculated	<LOD	0.200 (<LOD–0.200)	0.300 (0.200–0.300)	0.300 (0.300–0.300)	856
		2005–2006	Not calculated	<LOD	<LOD	0.220 (0.200–0.300)	0.260 (0.230–0.280)	934
		2007–2008	Not calculated	<LOD	<LOD	0.230 (0.210–0.240)	0.260 (0.240–0.280)	1,011
	12–19 Years	1999–2000	0.333 (0.304–0.366)	0.300 (<LOD–0.300)	0.300 (0.300–0.400)	0.800 (0.600–0.900)	1.10 (0.900–1.10)	2,135
		2001–2002	Not calculated	<LOD	0.300 (<LOD–0.300)	0.400 (0.400–0.500)	0.800 (0.600–1.10)	2,231
		2003–2004	Not calculated	0.200 (<LOD–0.200)	0.300 (0.300–0.300)	0.600 (0.500–0.700)	0.900 (0.800–1.10)	2,081
		2005–2006	Not calculated	<LOD	0.250 (0.240–0.270)	0.520 (0.500–0.700)	0.960 (0.820–1.08)	1,996
		2007–2008	Not calculated	<LOD	0.260 (0.240–0.270)	0.520 (0.400–0.670)	0.960 (0.730–1.19)	1,074

6. POTENTIAL FOR HUMAN EXPOSURE

Table 6-4. Geometric Mean and Selected Percentile Blood Concentrations (µg/L) of Cadmium in the U.S. Population from 1999 to 2008

Group	Survey years	Geometric mean ^a (95% CI)	Selected percentiles (95% CI)				Sample size
			50 th	75 th	90 th	95 th	
≥20 Years	1999–2000	0.468 (0.426–0.513)	0.400 (0.300–0.400)	0.600 (0.600–0.700)	1.00 (1.00–1.10)	1.50 (1.40–1.60)	4,207
	2001–2002	Not calculated	0.300 (0.300–0.400)	0.600 (0.500–0.600)	1.10 (0.900–1.20)	1.60 (1.30–1.80)	4,772
	2003–2004	0.378 (0.359–0.398)	0.400 (0.300–0.400)	0.600 (0.600–0.700)	1.20 (1.20–1.30)	1.80 (1.60–1.90)	4,525
	2005–2006	0.373 (0.352–0.395)	0.330 (0.310–0.350)	0.610 (0.570–0.660)	1.17 (1.06–1.26)	1.72 (1.53–1.95)	4,509
	2007–2008	0.376(0.354–0.399)	0.330 (0.310–0.350)	0.600 (0.550–0.670)	1.16 (1.02–1.30)	1.70 (1.50–1.96)	5,364
Gender							
Males	1999–2000	0.403 (0.368–0.441)	0.400 (0.300–0.400)	0.600 (0.500–0.600)	1.00 (0.900–1.10)	1.30 (1.20–1.50)	3,913
	2001–2002	Not calculated	0.300 (<LOD–0.300)	0.400 (0.400–0.500)	0.900 (0.900–1.10)	1.40 (1.20–1.80)	4,339
	2003–2004	0.283 (0.266–0.300)	0.300 (0.200–0.300)	0.500 (0.500–0.500)	1.10 (1.00–1.20)	1.60 (1.50–1.60)	4,131
	2005–2006	Not calculated	0.240 (0.220–0.260)	0.470 (0.420–0.530)	1.02 (0.910–1.12)	1.53 (1.27–1.86)	4,092
	2007–2008	0.299 (0.283–0.317)	0.240 (0.230–0.260)	0.470 (0.420–0.540)	1.05 (0.930–1.19)	1.60 (1.30–1.90)	4,147
Females	1999–2000	0.421 (0.386–0.460)	0.300 (0.300–0.400)	0.600 (0.500–0.600)	1.00 (0.800–1.00)	1.30 (1.10–1.40)	4,057
	2001–2002	Not calculated	0.300 (0.300–0.400)	0.500 (0.500–0.600)	1.00 (0.900–1.10)	1.40 (1.20–1.60)	4,606
	2003–2004	0.326 (0.300–0.300)	0.300 (0.300–0.300)	0.600 (0.500–0.600)	1.10 (1.00–1.20)	1.60 (1.50–1.70)	4,241
	2005–2006	0.329 (0.311–0.349)	0.290 (0.280–0.310)	0.530 (0.480–0.580)	1.02 (0.870–1.18)	1.54 (1.33–1.79)	4,315
	2007–2008	0.331 (0.316–0.348)	0.290 (0.280–0.310)	0.530 (0.480–0.570)	0.980 (0.860–1.10)	1.43 (1.29–1.63)	4,119
Race/ethnicity							
Mexican Americans	1999–2000	0.395 (0.367–0.424)	0.400 (0.300–0.400)	0.400 (0.400–0.500)	0.700 (0.700–0.900)	1.10 (0.900–1.30)	2,742
	2001–2002	Not calculated	<LOD	0.300 (0.300–0.400)	0.600 (0.500–0.700)	1.00 (0.700–1.30)	2,268
	2003–2004	0.235 (0.26–0.255)	0.200 (0.200–0.300)	0.400 (0.300–0.400)	0.600 (0.500–0.800)	1.00 (0.800–1.50)	2,085
	2005–2006	Not calculated	0.220 (0.200–0.240)	0.350 (0.300–0.400)	0.580 (0.510–0.680)	0.820 (0.710–1.00)	2,236
	2007–2008	Not calculated	0.220 (0.210–0.230)	0.350 (0.320–0.370)	0.570 (0.510–0.660)	0.870 (0.690–1.02)	1,712

6. POTENTIAL FOR HUMAN EXPOSURE

Table 6-4. Geometric Mean and Selected Percentile Blood Concentrations ($\mu\text{g/L}$) of Cadmium in the U.S. Population from 1999 to 2008

Group	Survey years	Geometric mean ^a (95% CI)	Selected percentiles (95% CI)				Sample size
			50 th	75 th	90 th	95 th	
Non-Hispanic blacks	1999–2000	0.393 (0.361–0.427)	0.300 (0.300–0.400)	0.600 (0.500–0.600)	1.00 (0.800–1.10)	1.40 (1.10–1.50)	1,842
	2001–2002	Not calculated	<LOD	0.400 (0.400–0.500)	1.00 (0.900–1.00)	1.40 (1.20–1.50)	2,219
	2003–2004	0.304 (0.275–0.337)	0.300 (0.300–0.300)	0.500 (0.400–0.600)	1.00 (0.900–1.20)	1.50 (1.30–1.70)	2,292
	2005–2006	0.307 (0.290–0.326)	0.260 (0.250–0.280)	0.490 (0.440–0.570)	1.03 (0.880–1.21)	1.50 (1.23–1.79)	2,193
	2007–2008	0.333 (0.316–0.352)	0.280 (0.270–0.300)	0.550 (0.480–0.620)	1.20 (1.02–1.36)	1.81 (1.45–2.13)	1,746
Non-Hispanic whites	1999–2000	0.376 (0.470–0.209)	0.400 (0.300–0.400)	0.500 (0.500–0.600)	1.00 (0.900–1.10)	1.30 (1.20–1.40)	2,716
	2001–2002	Not calculated	<LOD	0.500 (0.500–0.600)	0.900 (0.900–1.10)	1.40 (1.20–1.80)	3,806
	2003–2004	0.313 (0.296–0.331)	0.300 (0.300–0.300)	0.600 (0.500–0.600)	1.10 (1.00–1.20)	1.60 (1.50–1.70)	3,478
	2005–2006	0.321 (0.300–0.343)	0.270 (0.250–0.300)	0.540 (0.470–0.610)	1.08 (0.930–1.23)	1.64 (1.40–1.94)	3,310
	2007–2008	0.210 (0.303–0.341)	0.270 (0.260–0.290)	0.520 (0.470–0.580)	1.05 (0.920–1.20)	1.55 (1.30–1.80)	3,461

^aThe proportion of results below the LOD was too high to provide a valid result.

CI = confidence interval; LOD = limit of detection

Source: CDC 2011

6. POTENTIAL FOR HUMAN EXPOSURE

Table 6-5. Geometric Mean and Selected Percentile Urine Concentrations (Creatinine Corrected) ($\mu\text{g/g}$ Creatinine) of Cadmium in the U.S. Population from 1999 to 2008

Group	Survey years	Geometric mean ^a (95% CI)	Selected percentiles (95% CI)				Sample size
			50 th	75 th	90 th	95 th	
Total, age 6 and older	1999–2000	0.181 (0.157–0.209)	0.219 (0.199–0.238)	0.423 (0.391–0.446)	0.712 (0.645–0.757)	0.933 (0.826–1.07)	2,257
	2001–2002	0.199 (0.181–0.218)	0.212 (0.194–0.232)	0.404 (0.377–0.440)	0.690 (0.630–0.754)	0.917 (0.813–0.998)	2,689
	2003–2004	0.210 (0.201–0.219)	0.208 (0.189–0.226)	0.412 (0.381–0.438)	0.678 (0.650–0.716)	0.940 (0.833–1.04)	2,543
	2005–2006	0.189 (0.169–0.210)	0.180 (0.160–0.200)	0.370 (0.310–0.430)	0.650 (0.590–0.720)	0.910 (0.770–1.08)	2,576
	2007–2008	0.193 (0.177–0.210)	0.190 (0.180–0.210)	0.370 (0.330–0.410)	0.660 (0.580–0.740)	0.960 (0.850–1.06)	2,627
Age group							
6–11 Years	1999–2000	Not calculated	0.085 (0.063–0.107)	0.147 (0.123–0.182)	0.210 (0.171–0.316)	0.300 (0.184–0.607)	310
	2001–2002	0.075 (0.059–0.094)	0.100 (0.083–0.112)	0.166 (0.136–0.192)	0.233 (0.206–0.281)	0.291 (0.221–0.440)	368
	2003–2004	0.090 (0.078–0.104)	0.091 (0.075–0.104)	0.126 (0.111–0.156)	0.200 (0.147–0.350)	0.308 (0.178–0.415)	287
	2005–2006	0.081 (0.072–0.092)	0.080 (0.070–0.090)	0.130 (0.110–0.140)	0.170 (0.150–0.190)	0.200 (0.180–0.240)	355
	2007–2008	0.084 (0.076–0.092)	0.080 (0.080–0.090)	0.120 (0.110–0.140)	0.180 (0.150–0.240)	0.260 (0.180–0.430)	394
12–19 Years	1999–2000	0.071 (0.051–0.098)	0.093 (0.084–0.106)	0.147 (0.130–0.163)	0.215 (0.204–0.240)	0.283 (0.222–0.404)	648
	2001–2002	0.078 (0.067–0.091)	0.091 (0.085–0.101)	0.136 (0.123–0.143)	0.191 (0.175–0.234)	0.280 (0.234–0.321)	762
	2003–2004	0.086 (0.077–0.096)	0.084 (0.074–0.097)	0.122 (0.113–0.135)	0.176 (0.154–0.198)	0.234 (0.187–0.274)	724
	2005–2006	0.076 (0.071–0.081)	0.080 (0.070–0.0990)	0.120 (0.110–0.130)	0.50 (0.140–0.180)	0.210 (0.160–0.240)	701
	2007–2008	0.070 (0.062–0.079)	0.070 (0.070–0.080)	0.110 (0.100–0.110)	0.150 (0.130–0.160)	0.180 (0.160–0.200)	376
≥ 20 Years	1999–2000	0.267 (0.247–0.289)	0.288 (0.261–0.304)	0.484 (0.433–0.545)	0.769 (0.727–0.818)	1.07 (0.927–1.17)	1,299
	2001–2002	0.261 (0.236–0.289)	0.273 (0.247–0.303)	0.481 (0.426–0.518)	0.776 (0.691–0.850)	0.979 (0.874–1.12)	1,559
	2003–2004	0.268 (0.255–0.281)	0.270 (0.247–0.292)	0.490 (0.444–0.538)	0.767 (0.688–0.830)	1.02 (0.909–1.14)	1,532
	2005–2006	0.240 (0.216–0.267)	0.250 (0.200–0.260)	0.440 (0.400–0.500)	0.730 (0.660–0.820)	1.02 (0.850–1.18)	1,520
	2007–2008	0.247 (0.227–0.270)	0.250 (0.220–0.270)	0.430 (0.390–0.70)	0.740 (0.670–0.840)	1.05 (0.930–1.16)	1,857

6. POTENTIAL FOR HUMAN EXPOSURE

Table 6-5. Geometric Mean and Selected Percentile Urine Concentrations (Creatinine Corrected) ($\mu\text{g/g}$ Creatinine) of Cadmium in the U.S. Population from 1999 to 2008

Group	Survey years	Geometric mean ^a (95% CI)	Selected percentiles (95% CI)				Sample size
			50 th	75 th	90 th	95 th	
Gender							
Males	1999–2000	0.154 (0.131–0.182)	0.174 (0.158–0.191)	0.329 (0.293–0.382)	0.617 (0.537–0.700)	0.788 (0.696–0.929)	1,121
	2001–2002	0.159 (0.143–0.177)	0.168 (0.157–0.182)	0.334 (0.304–0.364)	0.532 (0.491–0.653)	0.757 (0.690–0.856)	1,334
	2003–2004	0.173 (0.161–0.187)	0.162 (0.143–0.185)	0.325 (0.300–0.352)	0.591 (0.560–0.631)	0.740 (0.678–0.795)	1,277
	2005–2006	0.160 (0.145–0.177)	0.150 (0.130–0.160)	0.300 (0.260–0.340)	0.362 (0.560–0.340)	0.820 (0.710–0.990)	1,271
	2007–2008	0.160 (0.146–0.175)	0.160 (0.140–0.180)	0.290 (0.260–0.330)	0.520 (0.430–0.650)	0.740 (0.600–0.960)	1,327
Females	1999–2000	0.211 (0.170–0.261)	0.267 (0.239–0.308)	0.473 (0.423–0.551)	0.783 (0.690–0.917)	1.09 (0.813–1.38)	1,136
	2001–2002	0.245 (0.216–0.278)	0.263 (0.228–0.297)	0.479 (0.414–0.541)	0.792 (0.687–0.884)	0.985 (0.876–1.16)	1,355
	2003–2004	0.252 (0.238–0.266)	0.253 (0.227–0.288)	0.487 (0.438–0.533)	0.802 (0.716–0.906)	1.06 (0.940–1.21)	1,266
	2005–2006	0.220 (0.193–0.252)	0.220 (0.180–0.250)	0.420 (0.370–0.470)	0.690 (0.590–0.850)	0.990 (0.780–1.31)	1,305
	2007–2008	0.231 (0.211–0.254)	0.230 (0.200–0.270)	0.440 (0.390–0.480)	0.770 (0.700–0.860)	1.09 (0.970–1.17)	1,300
Race/ethnicity							
Mexican Americans	1999–2000	0.175 (0.137–0.223)	0.181 (0.144–0.225)	0.331 (0.266–0.418)	0.612 (0.441–0.828)	0.843 (0.674–1.13)	780
	2001–2002	0.156 (0.136–0.177)	0.170 (0.150–0.184)	0.282 (0.263–0.340)	0.501 (0.388–0.614)	0.693 (0.507–0.839)	682
	2003–2004	0.160 (0.147–0.181)	0.159 (0.140–0.183)	0.296 (0.256–0.311)	0.531 (0.418–0.667)	0.718 (0.562–0.950)	614
	2005–2006	0.162 (0.146–0.181)	0.150 (0.140–0.170)	0.280 (0.220–0.340)	0.480 (0.430–0.510)	0.570 (0.520–0.640)	652
	2007–2008	0.162 (0.144–0.183)	0.160 (0.130–0.180)	0.280 (0.220–0.340)	0.530 (0.390–0.640)	0.720 (0.520–1.07)	515
Non-Hispanic blacks	1999–2000	0.183 (0.140–0.240)	0.201 (0.168–0.241)	0.414 (0.343–0.472)	0.658 (0.516–0.827)	0.873 (0.722–0.962)	546
	2001–2002	0.190 (0.156–0.232)	0.195 (0.174–0.225)	0.385 (0.336–0.449)	0.676 (0.559–0.850)	0.917 (0.725–1.08)	667
	2003–2004	0.190 (0.173–0.210)	0.185 (0.168–0.207)	0.338 (0.288–0.431)	0.700 (0.500–0.818)	0.865 (0.708–1.10)	717
	2005–2006	0.171 (0.159–0.183)	0.160 (0.140–0.180)	0.320 (0.290–0.370)	0.550 (0.500–0.580)	0.700 (0.610–0.730)	692
	2007–2008	0.180 (0.164–0.197)	0.170 (0.160–0.190)	0.330 (0.290–0.390)	0.600 (0.470–0.700)	0.770 (0.690–0.900)	589

6. POTENTIAL FOR HUMAN EXPOSURE

Table 6-5. Geometric Mean and Selected Percentile Urine Concentrations (Creatinine Corrected) ($\mu\text{g/g}$ Creatinine) of Cadmium in the U.S. Population from 1999 to 2008

Group	Survey years	Geometric mean ^a (95% CI)	Selected percentiles (95% CI)				Sample size
			50 th	75 th	90 th	95 th	
Non-Hispanic whites	1999–2000	0.175 (0.146–0.209)	0.219 (0.191–0.250)	0.432 (0.387–0.470)	0.729 (0.666–0.783)	1.00 (0.826–1.16)	760
	2001–2002	0.205 (0.184–0.229)	0.224 (0.208–0.242)	0.421 (0.382–0.470)	0.719 (0.668–0.784)	0.931 (0.806–1.05)	1,132
	2003–2004	0.220 (0.209–0.235)	0.221 (0.197–0.253)	0.434 (0.398–0.476)	0.687 (0.647–0.767)	1.00 (0.830–1.08)	1,070
	2005–2006	0.193 (0.169–0.221)	0.180 (0.160–0.220)	0.390 (0.310–0.480)	0.680 (0.630–0.750)	0.930 (0.800–1.07)	1,041
	2007–2008	0.199 (0.178–0.221)	0.200 (0.180–0.220)	0.380 (0.340–0.440)	0.700 (0.630–0.810)	1.03 (0.880–1.13)	1,095

^aThe proportion of results below the LOD was too high to provide a valid result.

CI = confidence interval; LOD = limit of detection

Source: CDC 2011

6. POTENTIAL FOR HUMAN EXPOSURE

Table 6-6. Geometric Mean and Selected Percentile Urine Concentrations (µg/L) of Cadmium in the U.S. Population from 1999 to 2008

Group	Survey years	Geometric mean ^a (95% CI)	Selected percentiles (95% CI)				Sample size
			50 th	75 th	90 th	95 th	
Total, age 6 and older	1999–2000	0.193 (0.169–0.220)	0.232 (0.214–0.249)	0.475 (0.436–0.519)	0.858 (0.763–0.980)	1.20 (1.06–1.33)	2,257
	2001–2002	0.210 (0.189–0.235)	0.229 (0.207–0.255)	0.458 (0.423–0.482)	0.839 (0.753–0.919)	1.20 (1.07–1.28)	2,690
	2003–2004	0.211 (0.196–0.226)	0.210 (0.200–0.230)	0.450 (0.400–0.500)	0.800 (0.730–0.880)	1.15 (0.980–1.26)	2,543
	2005–2006	0.191 (0.170–0.216)	0.200 (0.170–0.220)	0.400 (0.360–0.460)	0.780 (0.700–0.860)	1.05 (0.960–1.17)	2,576
	2007–2008	0.185 (0.173–0.198)	0.180 (0.170–0.200)	0.380 (0.360–0.400)	0.700 (0.50–0.770)	1.00 (0.920–1.12)	2,627
Age group							
6–11 Years	1999–2000	Not calculated	0.078 (0.061–0.101)	0.141 (0.115–0.173)	0.219 (0.178–0.233)	0.279 (0.211–0.507)	310
	2001–2002	0.061 (<LOD–0.081)	0.077 (0.067–0.092)	0.140 (0.112–0.160)	0.219 (0.184–0.262)	0.282 (0.260–0.326)	368
	2003–2004	0.077 (0.065–0.090)	0.080 (0.060–0.090)	0.120 (0.100–0.160)	0.190 (0.160–0.310)	0.310 (0.170–0.610)	287
	2005–2006	0.066 (0.056–0.078)	0.060 (0.050–0.080)	0.110 (0.090–0.130)	0.180 (0.130–0.240)	0.240 (0.160–0.290)	355
	2007–2008	0.064 (0.058–0.071)	0.060 (0.050–0.070)	0.110 (0.090–0.130)	0.180 (0.140–0.210)	0.230 (0.180–0.310)	394
12–19 Years	1999–2000	0.092 (0.067–0.126)	0.128 (0.107–0.148)	0.202 (0.183–0.232)	0.329 (0.272–0.372)	0.424 (0.366–0.596)	648
	2001–2002	0.109 (0.087–0.136)	0.135 (0.114–0.157)	0.210 (0.189–0.247)	0.327 (0.289–0.366)	0.442 (0.366–0.480)	762
	2003–2004	0.121 (0.190–0.134)	0.130 (0.110–0.150)	0.200 (0.160–0.190)	0.300 (0.260–0.360)	0.390 (0.330–0.490)	724
	2005–2006	0.099 (0.090–0.109)	0.110 (0.100–0.120)	0.170 (0.150–0.190)	0.240 (0.210–0.280)	0.310 (0.250–0.430)	701
	2007–2008	0.089 (0.079–0.100)	0.080 (0.070–0.110)	0.150 (0.140–0.170)	0.260 (0.200–0.300)	0.330 (0.280–0.410)	376
≥20 Years	1999–2000	0.281 (0.253–0.313)	0.306 (0.261–0.339)	0.551 (0.510–0.621)	0.979 (0.836–1.13)	1.31 (1.13–1.57)	1,299
	2001–2002	0.273 (0.249–0.299)	0.280 (0.261–0.308)	0.545 (0.493–0.607)	0.955 (0.855–1.06)	1.28 (1.20–1.43)	1,560
	2003–2004	0.260 (0.238–0.284)	0.210 (0.210–0.300)	0.260 (0.470–0.580)	0.890 (0.800–0.990)	1.25 (1.09–1.46)	1,532
	2005–2006	0.241 (0.213–0.272)	0.250 (0.220–0.290)	0.490 (0.440–0.560)	0.860 (0.790–0.930)	1.12 (1.06–1.32)	1,520
	2007–2008	0.232 (0.215–0.251)	0.240 (0.210–0.260)	0.450 (0.410–0.490)	0.790 (0.730–0.870)	1.13 (0.990–1.44)	1,857

6. POTENTIAL FOR HUMAN EXPOSURE

Table 6-6. Geometric Mean and Selected Percentile Urine Concentrations ($\mu\text{g/L}$) of Cadmium in the U.S. Population from 1999 to 2008

Group	Survey years	Geometric mean ^a (95% CI)	Selected percentiles (95% CI)				Sample size
			50 th	75 th	90 th	95 th	
Gender							
Males	1999–2000	0.199 (0.165–0.241)	0.227 (0.193–0.263)	0.462 (0.381–0.539)	0.892 (0.748–1.15)	1.41 (0.980–1.83)	1,121
	2001–2002	0.201 (0.177–0.229)	0.223 (0.191–0.257)	0.445 (0.393–0.481)	0.870 (0.741–1.03)	1.22 (1.12–1.38)	1,335
	2003–2004	0.206 (0.190–0.222)	0.210 (0.190–0.230)	0.440 (0.390–0.490)	0.790 (0.700–0.870)	1.01 (0.890–1.25)	1,277
	2005–2006	0.195 (0.176–0.217)	0.210 (0.190–0.230)	0.400 (0.360–0.440)	0.800 (0.730–0.890)	1.17 (1.01–1.30)	1,271
	2007–2008	0.179 (0.162–0.197)	0.180 (0.160–0.200)	0.360 (0.320–0.400)	0.670 (0.540–0.780)	0.950 (0.800–1.14)	1,327
Females	1999–2000	0.187 (0.153–0.229)	0.239 (0.220–0.255)	0.492 (0.456–0.540)	0.806 (0.705–0.980)	1.10 (1.01–1.19)	1,136
	2001–2002	0.219 (0.192–0.251)	0.234 (0.202–0.265)	0.466 (0.433–0.519)	0.817 (0.733–0.886)	1.17 (0.918–1.36)	1,355
	2003–2004	0.216 (0.195–0.238)	0.210 (0.200–0.240)	0.450 (0.400–0.530)	0.820 (0.700–0.960)	1.20 (1.02–1.37)	1,266
	2005–2006	0.188 (0.160–0.221)	0.190 (0.170–0.200)	0.400 (0.350–0.480)	0.750 (0.640–0.860)	0.980 (0.830–1.20)	1,305
	2007–2008	0.191 (0.177–0.207)	0.190 (0.170–0.200)	0.400 (0.370–0.430)	0.740 (0.670–0.840)	1.09 (0.940–1.38)	1,300
Race/ethnicity							
Mexican Americans	1999–2000	0.191 (0.157–0.233)	0.202 (0.167–0.221)	0.438 (0.351–0.551)	0.813 (0.686–0.977)	1.12 (0.886–1.38)	780
	2001–2002	0.160 (0.135–0.189)	0.181 (0.171–0.198)	0.321 (0.285–0.362)	0.559 (0.430–0.733)	0.766 (0.633–1.15)	683
	2003–2004	0.175 (0.151–0.203)	0.170 (0.150–0.210)	0.350 (0.290–0.430)	0.680 (0.520–0.820)	1.04 (0.820–1.20)	614
	2005–2006	0.173 (0.152–0.193)	0.180 (0.160–0.200)	0.340 (0.300–0.380)	0.560 (0.500–0.630)	0.780 (0.660–0.900)	652
	2007–2008	0.160 (0.141–0.182)	0.170 (0.140–0.210)	0.320 (0.290–0.380)	0.570 (0.520–0.640)	0.730 (0.640–0.840)	515
Non-Hispanic blacks	1999–2000	0.283 (0.208–0.387)	0.312 (0.243–0.412)	0.633 (0.498–0.806)	1.22 (0.892–1.38)	1.48 (1.30–1.72)	546
	2001–2002	0.277 (0.229–0.336)	0.302 (0.257–0.354)	0.580 (0.476–0.713)	1.04 (0.843–1.38)	1.51 (1.28–1.74)	667
	2003–2004	0.265 (0.237–0.295)	0.270 (0.220–0.320)	0.550 (0.440–0.640)	0.960 (0.810–1.17)	1.52 (1.06–1.82)	717
	2005–2006	0.236 (0.240–0.210)	0.240 (0.210–0.260)	0.480 (0.420–0.530)	0.830 (0.670–0.930)	1.04 (0.870–1.26)	692
	2007–2008	0.246 (0.218–0.277)	0.260 (0.220–0.300)	0.460 (0.420–0.530)	0.840 (0.690–0.980)	1.40 (0.900–1.85)	589

6. POTENTIAL FOR HUMAN EXPOSURE

Table 6-6. Geometric Mean and Selected Percentile Urine Concentrations ($\mu\text{g/L}$) of Cadmium in the U.S. Population from 1999 to 2008

Group	Survey years	Geometric mean ^a (95% CI)	Selected percentiles (95% CI)				Sample size
			50 th	75 th	90 th	95 th	
Non-Hispanic whites	1999–2000	0.175 (0.148–0.206)	0.220 (0.194–0.246)	0.455 (0.388–0.510)	0.797 (0.714–1.01)	1.17 (0.963–1.47)	760
	2001–2002	0.204 (0.179–0.231)	0.221 (0.191–0.255)	0.445 (0.394–0.479)	0.813 (0.717–0.875)	1.17 (0.989–1.24)	1,132
	2003–2004	0.209 (0.192–0.226)	0.200 (0.190–0.220)	0.440 (0.390–0.500)	0.790 (0.700–0.860)	1.13 (0.940–1.26)	1,070
	2005–2006	0.185 (0.159–0.216)	0.200 (0.160–0.230)	0.400 (0.330–0.480)	0.780 (0.670–0.920)	1.05 (0.940–1.25)	1,041
	2007–2008	0.177 (0.161–0.195)	0.170 (0.150–0.190)	0.370 (0.330–0.400)	0.690 (0.620–0.780)	1.00 (0.880–1.12)	1,095

^aThe proportion of results below the LOD was too high to provide a valid result.

CI = confidence interval; LOD = limit of detection

Source: CDC 2011

6. POTENTIAL FOR HUMAN EXPOSURE

As a part of the New York City Health and Nutrition Examination Survey (NYC HANES), 2004 blood cadmium levels were evaluated in 1,811 New York City adults (age 20 years and older). The variables used in this study were sex, age, race/ethnicity, place of birth, family income, education, and smoking status (see [Table 6-7](#) for detailed results of this study). The geometric mean blood cadmium concentration in New York City adults was 0.77 µg/L, slightly higher than the 1999–2000 estimated national mean of 0.47 µg/L with heavy smokers having the highest geometric mean blood cadmium level of 1.58 µg/L, higher than any other subgroup. The reason for the elevated blood cadmium levels in nonsmoking, New York City adults is not known, although it was speculated that higher shellfish consumption may be the cause of elevated blood cadmium levels in Asian subgroup (McKelvey et al. 2007).

Vahter et al. (1996) studied the dietary intake and uptake of cadmium in nonsmoking women consuming a mixed diet low in shellfish (n=34) or with shellfish once a week or more (n=17). The shellfish diets, with a median of 22 µg Cd/day, contained twice as much cadmium as the mixed diets, which had a median of 10.5 µg Cd/day. In spite of the differences in the daily intake of cadmium, there were no statistically significant differences in the blood cadmium concentrations of the shellfish group (0.25 µg/L) and the mixed diet group (0.23 µg/L) or in the urinary cadmium concentrations of the shellfish and mixed diet groups (0.10 µg/L in both groups). These results indicate a lower absorption of cadmium in the shellfish group than in the mixed diet group or a difference in kinetics. The authors suggested that a higher gastrointestinal absorption of cadmium in the mixed diet group could be explained in part by their lower body iron stores as measured by the concentrations of serum ferritin (S-fer). A median S-fer concentration of 18 µg/L was measured for the mixed diet group compared to a median of 31 µg/L for the shellfish group.

Except in the vicinity of cadmium-emitting industries or incinerators, the intake of cadmium from drinking water or ambient air is of minor significance (Elinder 1985a). Cadmium is removed from waste water and sewage through precipitation to hydroxide or carbonate compounds and ultimate separation (Schulte-Schrepping and Piscator 2002). EPA requires water suppliers to limit the cadmium concentration in water to <5 µg/L (EPA 2006a).

IARC (1993) reports that the total body burden of non-occupationally exposed adult subjects has been estimated to range from 9.5 to 50 mg in the United States and Europe. People living near sources of cadmium pollution may be exposed to higher levels of cadmium. Ambient air cadmium concentrations in industrialized areas was estimated between 15 and 150 ng/m³ (Morrow 2001). During a study conducted

6. POTENTIAL FOR HUMAN EXPOSURE

Table 6-7. Blood Cadmium Concentrations, Geometric Means, Adjusted Proportional Change in Means, and 95th Percentiles in New York City Adults in Population Subgroups

Variable	Number ^a	Results		
		Crude weighted geometric mean blood cadmium (µg/L)	Adjusted proportional change in mean blood cadmium (µg/L) ^b	Crude weighted 95 th percentile blood cadmium (µg/L)
Total:	1,811	0.77	—	1.88
Male	762	0.76	1.00	1.95
Female	1,049	0.79	1.07	1.83
20–39 years old	903	0.76	1.00	1.82
40–59 years old	673	0.84	1.16	2.19
≥60 years old	235	0.77	1.15	1.52
White, non-Hispanic ^c	529	0.73	1.04	1.71
Black, non-Hispanic ^c	390	0.80	1.11	1.97
Asian, non-Hispanic ^c	231	0.99	1.41	2.36
Hispanic ^c	630	0.73	1.00	1.73
Place of birth:				
United States	882	0.76	1.00	1.95
Outside the United States	923	0.79	1.02	1.73
Family income (\$ U.S.):				
<20,000	610	0.86	1.00	2.33
20,000–49,999	566	0.77	0.94	1.76
50,000–74,999	256	0.74	0.92	1.76
≥75,000	304	0.69	0.91	1.43
Education:				
<Bachelors	1,252	0.82	1.09	2.02
Bachelors or greater	551	0.69	1.00	1.43
Smoking status:				
Never smoked	1,036	0.66	1.00	1.28
Former smoker	310	0.71	1.07	1.32
Current smoker	449	1.22	1.88	3.00

^aTotals do not all equal 1,811 because of missing data.

^bThe exponential β coefficient from a log-linear multiple regression that includes all covariates in the table. Sample size for adjust analysis is 1,707, after excluding study participants for whom covariate data are missing.

^cExcludes 27 participants who self-classified as “other”.

Source: McKelvey et al. 2007

6. POTENTIAL FOR HUMAN EXPOSURE

in Germany between March and May 2000, cadmium levels in child-mother pairs, as a function of ambient air quality, were compared between populations in the urban, industrialized area of Duisburg and the rural area of North Rhine Westphalia. Cadmium levels in the ambient air of Duisburg-South ranged from 1.5 to 31 ng/m³, compared to 0.5 ng/m³ in the rural area of Westphalia. Cadmium levels in the blood and urine of mothers in the industrialized area were higher than in the rural areas. Cadmium levels in the blood and urine of the children did not differ between the two areas. In the industrialized area, regression analysis indicated a significant influence of cadmium in ambient air on cadmium in blood (Wilhelm et al. 2005).

It has been estimated that tobacco contains 1.7 µg cadmium per cigarette, and about 10% is inhaled when smoked (Morrow 2001; NTP 2005). Tobacco leaves naturally accumulate large amounts of cadmium (Morrow 2001). During a study monitoring cadmium levels in 331 cigarette packs from over 20 areas around the world, it was found that the mean cadmium level per cigarette was 1.15 µg/cigarette ±0.43 (AM±ASD) or 1.06 µg/cigarette ±1.539 GM±GSD. Cigarettes from Mexico had the highest mean level of cadmium with an AM±ASD of 2.03 µg/cigarette ±0.33 or a GM±GSD of 2.00 µg/cigarette ±1.190. Cigarettes from India had the lowest mean levels of cadmium with an AM±ASD of 0.35 µg/cigarette ±0.09 or a GM±GSD of 0.34 µg/cigarette ±1.284 (Watanabe et al. 1987). The amount of cadmium absorbed from smoking one pack of cigarettes per day is about 1–3 µg/day (Lewis et al. 1972a; Nordberg et al. 1985), roughly the same as from the diet. This large contribution is due to the greater absorption of cadmium from the lungs than from the gastrointestinal tract (Elinder 1985a). Direct measurement of cadmium levels in body tissues confirms that smoking roughly doubles cadmium body burden in comparison to not smoking, with kidney concentrations averaging 15–20 µg/g wet weight for nonsmokers and 30–40 µg/g wet weight for heavy smokers at the age of 50–60 (Ellis et al. 1979; Hammer et al. 1973; Lewis et al. 1972a, 1972b). Ellis et al. (1979) found an increase in kidney cadmium of 0.11±0.05 mg per pack-year (AM±ASD) of smoking and an increase in liver cadmium concentration of 0.077±0.065 µg/g per pack-year (AM±ASD). Because excretion of cadmium is very slow, half-lives of cadmium in the body are correspondingly long (17–38 years) (Wester et al. 1992).

Workers in a variety of occupations may be exposed to cadmium and cadmium compounds. Occupations with potential exposure to cadmium are listed in [Table 6-8](#) (IARC 1993).

Highest levels of occupational exposure would be expected to occur in operations involving heating cadmium-containing products by smelting, welding, soldering, or electroplating, and also in operations associated with producing cadmium powders (OSHA 1990). The primary route of occupational exposure

6. POTENTIAL FOR HUMAN EXPOSURE

Table 6-8. Occupations with Potential Exposure to Cadmium and Cadmium Compounds

Occupation	
Alloy production ^a	Phosphorous production
Battery production ^a	Pigment production and use ^a
Brazing	Plastics production ^a
Coating	Plating
Diamond cutting	Printing
Dry color formulation	Semiconductor and superconductor production
Electroplating	Sensors production
Electrical contacts production	Smelting and refining ^a
Enameling	Solar cells production
Engraving	Soldering
Glasswork	Stabilizer production
Laser cutting	Textile printing
Metallizing	Thin film production
Paint production and use	Transistors production
Pesticide production and use	Welding

^aActivity with high risk because atmospheric concentrations of cadmium are high and the number of workers employed is significant.

Source: IARC 1993

6. POTENTIAL FOR HUMAN EXPOSURE

is through inhalation of dust and fumes, and also incidental ingestion of dust from contaminated hands, cigarettes, or food (Adamsson et al. 1979).

Concentrations of airborne cadmium found in the workplace vary considerably with the type of industry and the specific working conditions. Processes that involve high temperatures can generate cadmium oxide fumes that are absorbed very efficiently through the lungs (IARC 1993). Deposition and absorption of dust containing different compounds depend upon particle size (IARC 1993). These exposures can be controlled through use of personal protective equipment and good industrial hygiene practices, and through operating procedures designed to reduce workplace emissions of cadmium (OSHA 1990).

Data from the National Occupational Exposure Survey (NOES), conducted by NIOSH from 1981 to 1983, estimated the number of workers potentially exposed to various chemicals in the workplace during the same period (NIOSH 1990); these data are summarized in [Table 6-9](#). The NOES database does not contain information on the frequency, level, or duration of exposure of workers to any of the chemicals listed. It provides only estimates of workers potentially exposed to the chemicals.

6.6 EXPOSURES OF CHILDREN

This section focuses on exposures from conception to maturity at 18 years in humans. Differences from adults in susceptibility to hazardous substances are discussed in Section 3.7, Children's Susceptibility.

Children are not small adults. A child's exposure may differ from an adult's exposure in many ways. Children drink more fluids, eat more food, breathe more air per kilogram of body weight, and have a larger skin surface in proportion to their body volume. A child's diet often differs from that of adults. The developing human's source of nutrition changes with age: from placental nourishment to breast milk or formula to the diet of older children who eat more of certain types of foods than adults. A child's behavior and lifestyle also influence exposure. Children crawl on the floor, put things in their mouths, sometimes eat inappropriate things (such as dirt or paint chips), and spend more time outdoors. Children also are closer to the ground, and they do not use the judgment of adults to avoid hazards (NRC 1993).

Children are most likely to be exposed to cadmium in from ingestion of food (NTP 2005). There are no data on gastrointestinal absorption of cadmium in children, although very limited evidence exists that cadmium absorption from the gut may be greater in young animals. Oral absorption is discussed in more detail in Section 3.4.1.2. A study performed in Cincinnati, Ohio, investigated cadmium in human milk

6. POTENTIAL FOR HUMAN EXPOSURE

Table 6-9. Estimated Number of Workers Potentially Exposed to Various Chemicals in the Workplace in 1981–1983

Chemical	Number of workers potentially exposed
Cadmium sulfide	45,562
Cadmium oxide	15,727
Cadmium (pure)	335
Cadmium dust (form unknown)	3,893
Cadmium powder (form unknown)	486
Cadmium sulfate	1,313
1:1 Cadmium salt of carbonic acid	164
Cadmium (form unknown)	88,968
Total	153,486

Source: NIOSH 1990

6. POTENTIAL FOR HUMAN EXPOSURE

and found a mean concentration of 19 ppb (0.019 ppm) (Jensen 1983). The NHANES 1999–2008 reported cadmium levels in blood (see Table 6-4) and urine (see Tables 6-5 and 6-6) for children in different age groups (CDC 2011). The NYC HANES did not test for blood cadmium levels in children, although the blood cadmium levels in adults were slightly higher than the national average (McKelvey et al. 2007). Results of the U.S. FDA Total Diet Study (Capar and Cunningham 2000) reported cadmium levels in infant and junior foods ranged from no detection to 0.090 mg/kg. According to the National Human Exposure Assessment Survey (NHEXAS), children in EPA Region V (Great Lakes Region) have a mean dietary cadmium exposure of 17 (± 1.8) $\mu\text{g}/\text{kg}$ for minority children and 21 (± 2.2) $\mu\text{g}/\text{kg}$ for non-minority children (Pellizzari et al. 1999).

Except in the vicinity of cadmium-emitting industries or incinerators, the intake of cadmium from drinking water or ambient air is of minor significance (Elinder 1985a). Ambient air cadmium concentrations in industrialized areas has been estimated between 15 and 150 ng/m^3 (Morrow 2001). Cadmium levels in the ambient air of Duisburg-South, Germany ranged from 1.5 to 31 ng/m^3 , compared to 0.5 ng/m^3 in the rural are of Westphalia. Cadmium levels in the blood and urine of mothers in the industrialized area were higher than in the rural areas. Cadmium levels in the blood and urine of the children did not differ between the two areas. In the industrialized area, regression analysis indicated a significant influence of cadmium in ambient air on cadmium in blood (Wilhelm et al. 2005). Children in the homes of parents who smoke also can be exposed to cadmium through the inhalation of environmental tobacco smoke. There is potential for cadmium originating from second-hand smoke to settle onto surfaces; thus, there is a possibility that children may ingest cadmium from contaminated surfaces by the hand-to-mouth pathway. Although no data were found, children playing near hazardous waste sites could be exposed to cadmium in soil by hand-to-mouth activity and/or soil pica. No case studies were found on accidental poisoning of children by swallowing cadmium-containing batteries or by ingesting cadmium-containing household pesticides, which also are potential routes of exposure. No information was found concerning differences in the weight-adjusted intakes of cadmium by children.

In the Workers' Home Contamination Study conducted under the Workers' Family Protection Act (DHHS 1995), several studies were identified that reported home contamination with cadmium originating from parental occupation in a lead smelter. In a study of 396 children of ages 1–9 years living <900 m from a primary lead smelter, 380 children (96%) had blood cadmium (CdB) levels $>0.0089 \mu\text{g}/\text{L}$ (Carvalho et al. 1986). The geometric mean and standard deviation were 0.087 $\mu\text{mol}/\text{L}$ and 2.5, respectively. No significant relationship was found between parental occupation in the smelter and CdB in children, but a significant relationship was found between presence of smelter dross in the house and

6. POTENTIAL FOR HUMAN EXPOSURE

elevated CdB in children. Higher CdB was significantly associated with shorter distance from the home to the smelter. In a similar study of 263 children (ages 1–9 years), living <900 m from a primary lead smelter, the mean cadmium in hair was significantly higher at 6.0 ppm for children whose fathers worked in lead smelters than the concentration of 3.7 ppm for children whose fathers had other jobs (Carvalho et al. 1989). In a study of 9 children from families of lead workers and 195 children (ages 4–17 years) from other families, the children from the families of lead workers had significantly higher geometric mean urinary cadmium (CdU) ($0.34 \mu\text{g/L} \pm 2.6$) than children from other families ($0.13 \mu\text{g/L} \pm 2.2$). The CdB levels of children from families of lead workers were higher than those of the children from other families, but the difference was not statistically significant (Brockhaus et al. 1988). Maravelias et al. (1989) measured the CdBs of 514 children (ages 5–12) from four schools located within various distances (500–1500 m) from a lead smelter. The geometric mean and geometric standard deviation CdB was $0.36 \mu\text{g/L} \pm 1.4$, respectively, with a range of 0.1–3.1 $\mu\text{g/L}$. Children from the school closest to the smelter had higher CdB levels than children from other schools, but no relationship was found between childrens' CdB and parental employment in the smelter.

The placenta may act as a partial barrier to fetal exposure to cadmium. Cadmium concentration has been found to be approximately half as high in cord blood as in maternal blood in several studies including both smoking and nonsmoking women (Kuhnert et al. 1982; Lauwerys et al. 1978; Truska et al. 1989). Accumulation of cadmium in the placenta at levels about 10 times higher than maternal blood cadmium concentration has been found in studies of women in Belgium (Roels et al. 1978) and the United States (Kuhnert et al. 1982); however, in a study in Czechoslovakia, the concentration of cadmium in the placenta was found to be less than in either maternal or cord blood (Truska et al. 1989). Baranowska (1995) also measured the concentrations of cadmium and lead in human placenta and in maternal and neonatal (cord) blood to assess the influence of a strongly polluted environment on the content of metals in tissues and on the permeability of the placenta to cadmium and lead. Samples for the study were collected from women living in the industrial district of Upper Silesia, one of the most polluted regions in Poland. The mean (range) concentration of cadmium in the air was $11.3 (2.1\text{--}25.4) \text{ ng/m}^3$ ($0.0113 [0.0021\text{--}0.0254] \mu\text{g/m}^3$). The mean concentrations of cadmium were 4.90 ng/mL ($0.00490 \mu\text{g/mL}$) in venous blood, $0.11 \mu\text{g/g}$ in placenta, and 1.13 ng/mL ($0.00113 \mu\text{g/mL}$) in cord blood. The researcher concluded that the placenta is a better barrier for cadmium than for lead, based upon the relative decrease in metal concentrations from placenta to cord blood. The mechanism by which the placenta transports the essential metals, copper and zinc, while limiting the transport of cadmium is unknown, but may involve the approximately 1,000-fold higher concentration of zinc in the placenta and the higher affinity of cadmium than zinc for metallothionein (Goyer and Cherian 1992). Timing and level

6. POTENTIAL FOR HUMAN EXPOSURE

of cadmium exposure may influence the uptake of cadmium by the placenta, perhaps explaining the conflicting human studies. Galicia-García et al. (1995) performed analyses of cadmium in maternal, cord, and newborn blood for 50 births in a Mexico City hospital. Multiple regression analyses applied to the data indicated a significant association between cord and newborn blood and between cord and maternal blood, but not among maternal and newborn blood. Birth weight of the newborns was found to be inversely associated with cord blood cadmium levels and smoking habits.

The analysis of Weidenberg et al. (2011) on the bioavailability of cadmium present in inexpensive jewelry suggests that substantial quantities of cadmium may be released from jewelry that is mouthed or swallowed and that the amount released was greatly varied from item to item.

6.7 POPULATIONS WITH POTENTIALLY HIGH EXPOSURES

The greatest potential for above-average exposure of the general population to cadmium is from smoking, which may double the exposure of a typical individual. Smokers who are exposed to cadmium in the workplace are at highest risk (CDC 2005). Individuals living near zinc or lead smelting operations, municipal incinerators, or other industrial processes emitting cadmium to the air will also have above-average exposure (Elinder 1985a). Exposures through inhalation are diminishing due to pollution controls at such facilities, but exposure resulting from soil contamination may continue to be significant. Persons who have corrosive drinking water and cadmium-containing plumbing, who habitually consume cadmium-concentrating foods (kidney, liver, and shellfish), or who ingest grains or vegetables grown in soils treated with municipal sludge or phosphate fertilizer all may have increased exposure (Elinder 1985a). The 2004 NYC HANES indicated that the New York City Asian population, especially those born in China, had higher concentrations of cadmium in blood. The authors speculate that this might be due to higher consumption of fish and shellfish (McKelvey et al. 2007).

Multiple pathways of exposure may exist for populations at hazardous waste sites contaminated with cadmium (ingestion of contaminated drinking water or garden vegetables, inhalation of airborne dust, incidental ingestion of contaminated soil).

Persons who consume large quantities of sunflower kernels can be exposed to higher levels of cadmium. Reeves and Vanderpool (1997) identified specific groups of men who were likely to consume sunflower kernels. The groups included baseball and softball players, delivery and long-distance drivers, and line workers in sunflower kernel processing plants.

6. POTENTIAL FOR HUMAN EXPOSURE

Recreational and subsistence fishers that consume appreciably higher amounts of locally caught fish from contaminated waterbodies may be exposed to higher levels of cadmium associated with dietary intake (EPA 1993a). Cadmium contamination has triggered the issuance of several human health advisories. As of December 1997, cadmium was identified as the causative pollutant in five fish and shellfish consumption advisories in New York and another in New Jersey. EPA is considering including cadmium as a target analyte and has recommended that this metal be monitored in fish and shellfish tissue samples collected as part of state toxics monitoring programs. EPA recommends that residue data obtained from these monitoring programs be used by states to conduct risk assessments to determine the need for issuing fish and shellfish consumption advisories for the protection of the general public as well as recreational and subsistence fishers. Under the same program, EPA has issued a statewide advisory in Maine for cadmium in moose (EPA 1998).

6.8 ADEQUACY OF THE DATABASE

Section 104(i)(5) of CERCLA, as amended, directs the Administrator of ATSDR (in consultation with the Administrator of EPA and agencies and programs of the Public Health Service) to assess whether adequate information on the health effects of cadmium is available. Where adequate information is not available, ATSDR, in conjunction with NTP, is required to assure the initiation of a program of research designed to determine the health effects (and techniques for developing methods to determine such health effects) of cadmium.

The following categories of possible data needs have been identified by a joint team of scientists from ATSDR, NTP, and EPA. They are defined as substance-specific informational needs that if met would reduce the uncertainties of human health assessment. This definition should not be interpreted to mean that all data needs discussed in this section must be filled. In the future, the identified data needs will be evaluated and prioritized, and a substance-specific research agenda will be proposed.

6.8.1 Identification of Data Needs

Physical and Chemical Properties. The chemical and physical properties of cadmium and its salts are known well enough to permit estimation of the environmental fate of the compounds (Elinder 1985a, 1992). Additional information on properties does not appear to be crucial for evaluating potential fate.

6. POTENTIAL FOR HUMAN EXPOSURE

Production, Import/Export, Use, Release, and Disposal. According to the Emergency Planning and Community Right-to-Know Act of 1986, 42 U.S.C. Section 11023, industries are required to submit substance release and off-site transfer information to the EPA. The TRI, which contains this information for 2009, became available in February of 2011. This database is updated yearly and should provide a list of industrial production facilities and emissions.

The production volume, producers, import/export quantities, and uses of cadmium in the United States are well documented (SRI 2007; USGS 2007, 2008). Recycling of cadmium from spent batteries is increasing, and there are some data to suggest that there is still a large portion of cadmium being disposed of as municipal waste (USGS 2007). More data concerning the amount of municipal disposal would be helpful. Disposal of cadmium-containing wastes is regulated by the federal government, and data are available for industrial disposal practices (EPA 1982a; HSDB 2008; U.S. Bureau of Mines 1990). Most releases of cadmium are not from production of the metal or its compounds, but from combustion or smelter emissions, land application of sewage sludge and fertilizers, and other sources; estimates of these releases have been made (TRI09 2011).

Environmental Fate. Cadmium partitioning among media occurs, and this partitioning depends on local environmental conditions (Elinder 1985a, 1992). Cadmium may be subject to long-range transport in air and water (EPA 1980d). Cadmium is persistent in all media, although it may form organic complexes in soil and water under certain environmental conditions (EPA 1979). These processes, which are important for determining the environmental fate of cadmium, seem to be relatively well understood. Therefore, additional information on environmental fate does not appear to be essential to evaluate potential human exposure to cadmium.

Bioavailability from Environmental Media. Factors that control the bioavailability of cadmium from air, water, soil, and food have been investigated. Intestinal absorption of cadmium from food is low, about 5–10% (McLellan et al. 1978; Newton et al. 1984; Rahola et al. 1973), but the absorption of cadmium from soil is not known. Absorption from the lungs is somewhat greater, averaging about 25% (Nordberg et al. 1985). Estimates of dermal absorption of cadmium from soil and water on human skin have been made (Wester et al. 1992). There is some evidence that bioavailability of cadmium to plants and worms from contaminated soil is greater following remediation (Van Gestel et al. 1988). Additional information on the factors influencing bioavailability, particularly from remediated soil, are needed to assess residual risk to populations in the vicinity of reclaimed hazardous waste sites.

6. POTENTIAL FOR HUMAN EXPOSURE

Food Chain Bioaccumulation. Sufficient data are available to indicate that cadmium is concentrated in plants, aquatic organisms, and animals (Alloway et al. 1990; Beyer 1986; Handy 1992a, 1992b; Kuroshima 1992; Naqvi and Howell 1993; Roseman et al. 1994; Suresh et al. 1993; Vos et al. 1990). In vertebrates, cadmium accumulates in the liver and kidneys (Harrison and Klaverkamp 1990; Sileo and Beyer 1985; Vos et al. 1990). There is strong evidence for food chain bioaccumulation, but the potential for biomagnification is uncertain. Additional studies on biomagnification are needed to provide data for more accurate evaluation of the environmental impact of cadmium contamination.

Exposure Levels in Environmental Media. Reliable monitoring data for the levels of cadmium in contaminated media at hazardous waste sites are needed so that the information obtained on levels of cadmium in the environment can be used in combination with the known body burden of cadmium to assess the potential risk of adverse health effects in populations living in the vicinity of hazardous waste sites.

Current ambient air quality surveys testing for cadmium concentrations in rural and urban locations in the United States is lacking. Since the major source of exposure to cadmium is through dietary intake and since cadmium emissions to air are not expected to increase, there may be less interest in these data. There are several long-range atmospheric transport studies, but since these were conducted Europe and Russia, they only illustrate the potential for cadmium contamination via atmospheric deposition in the United States (Reimann et al. 1997; Shevchenko et al. 2003; Vidovic et al. 2005). There is also minimal data on current levels of cadmium in agricultural soils of the United States and the identification of the sources of cadmium levels, whether they are native geochemistry, phosphate fertilizers, atmospheric deposition, etc. (Xue et al. 2000). Continuing monitoring efforts in all media would allow more precise estimation of current sources and levels of human exposure and would assist in identifying major sources contributing to current exposure.

Exposure Levels in Humans. Cadmium has been detected in human blood, urine, breast milk, liver, kidney, and other tissues, both in occupationally exposed individuals and in the general population (CDC 2011; McKelvey et al. 2007; OSHA 1990). The NHANES and NYC HANES provide current data on the levels of cadmium in humans (CDC 2011; McKelvey et al. 2007). Other large-scale surveys concentrating on urban, agricultural, and suburban communities would be beneficial in understanding cadmium exposure to the U.S. population. Also, more information is needed on the specific exposure levels for different cadmium salts to determine if cadmium sulfides, for example, are associated with less harmful effects than cadmium oxides (Chettle and Ellis 1992).

6. POTENTIAL FOR HUMAN EXPOSURE

This information is necessary for assessing the need to conduct health studies on these populations.

Exposures of Children. Cadmium has been measured in maternal and neonatal (cord) blood and in placenta (Baranowska 1995; Galicia-García et al. 1995; Kuhnert et al. 1982; Lauwerys et al. 1978; Roels et al. 1978; Truska et al. 1989), but the resulting data are sometimes conflicting with respect to the uptake of cadmium by the placenta. Research on the effects of timing and level of exposure on cadmium uptake by the placenta might help to explain these conflicting human studies. More recent data would be useful, both from women and children living in unpolluted areas (for background levels) and in polluted areas such as those near existing or former lead smelters.

There are some current data concerning cadmium exposure in children (Capar and Cunningham 2000; CDC 2011; Pellizzari et al. 1999). The NHANES 1999–2008 reported cadmium levels in blood (see [Table 6-4](#)) and urine (see [Table 6-5](#)) for children in different age groups (CDC 2011). The NYC HANES did not test for blood cadmium levels in children, although the blood cadmium levels in adults were slightly higher than the national average (McKelvey et al. 2007). Results of the U.S. FDA Total Diet Study (Capar and Cunningham 2000) reported cadmium levels in infant and junior foods ranged from no detection to 0.090 mg/kg. According to the NHEXAS, children in EPA Region V (Great Lakes Region) have a mean dietary cadmium exposure of 17 (± 1.8) $\mu\text{g}/\text{kg}$ for minority children and 21 (± 2.2) $\mu\text{g}/\text{kg}$ for non-minority children (Pellizzari et al. 1999).

Some body burden data are available for children living near lead smelters (Lagerkvist and Lundstrom 2004; Leroyer et al. 2001; Jin et al. 2002). However, none of the studies took place in the United States. Body burden data from children living in polluted and unpolluted regions (for background levels) of the United States are needed.

Current information on whether children are different in their weight-adjusted intake of cadmium via oral, inhalation, and dermal exposures was not located. A study to determine this information would be useful. Also, no information was found on childhood specific means to reduce cadmium exposure.

Child health data needs relating to susceptibility are discussed in Section 3.12.2, Identification of Data Needs: Children's Susceptibility.

6. POTENTIAL FOR HUMAN EXPOSURE

Exposure Registries. The State of New York has established the Heavy Metals Registry for surveillance of occupational heavy metals absorption. Cadmium levels $>10 \mu\text{g/L}$ in blood and $5 \mu\text{g/L}$ in urine are reported to the registry. The number of adults with reportable levels has varies per year, but there have always been <50 adults reported per year. Between 1995 and 2003, the number of reportable adults was <5 , and these exposures are due mostly to exposure for people working as jewelers and casting machine operators (NYS Dept of Health 2006).

No other exposure registries for cadmium were located. This substance is not currently one of the compounds for which a subregistry has been established in the National Exposure Registry. The substance will be considered in the future when chemical selection is made for subregistries to be established. The information that is amassed in the National Exposure Registry facilitates the epidemiological research needed to assess adverse health outcomes that may be related to exposure to this substance.

6.8.2 Ongoing Studies

The Federal Research in Progress (FEDRIP 2008) database provides additional information obtainable from a few ongoing studies that may fill in some of the data needs identified in Section 6.8.1. These studies are summarized in [Table 6-10](#).

6. POTENTIAL FOR HUMAN EXPOSURE

Table 6-10. Ongoing Studies on Cadmium

Investigator	Affiliation	Research description	Sponsor
Birnbaum ER	Caldera Pharmaceuticals, Inc., Los Alamos, New Mexico	Biomarkers of response to environmental stressors	National Institute of Environmental Health Sciences
Chen Z	X-Ray Optical Systems, Inc. East Greenbush, New York	Direct measurement of trace elements in body fluids	National Center for Research Resources
Dweik BM	Giner, Inc., Newton, Massachusetts	Field-deployable monitor to assess personal exposure to multiple heavy metals	National Institute of Environmental Health Sciences
Fallin MD	Johns Hopkins University, Baltimore, Maryland	AGE-related epigenetic changes - environmental causes and disease consequences	National Institute of Environmental Health Sciences
Fox MA	Johns Hopkins University, Baltimore, Maryland	Environmental exposure to metal mixtures and kidney disease	National Institute of Environmental Health Sciences
Larkin PM	Ecoarray, Inc. Alachua, Florida	Developing and using sheepshead minnow microarrays for ecotoxicology	National Institute of Environmental Health Sciences
Mo J	Kumetrix, Inc, Union City, California	Automatic multi-analyte in-situ bioassay for monitoring exposure to toxic metals	National Institute of Environmental Health Sciences
Polette-Niewold LA	Mayan Pigments, Inc.	SBIR phase II: One-step environmentally-friendly synthesis of novel organic/inorganic hybrid pigments	National Science Foundation
Santra S	University of Central Florida	Selective detection of toxic heavy metal ions using highly sensitive quantum dot probes	National Science Foundation
Basta N; Raun WR	Oklahoma State University	Chemistry and bioavailability of waste constituents in soils	U.S. Department of Agriculture
Basta NT	Oklahoma State University	Heavy metal and trace element chemistry in soils: Chemical speciation and bioavailability	U.S. Department of Agriculture
Basta NT; Lower SK; Lanno R	Ohio State University	Heavy metal and trace element biogeochemistry in soils: Chemical speciation, bioavailability, and toxicity	U.S. Department of Agriculture
Bleam WF; Helmke PA	University of Wisconsin	Verifying and quantifying the specific complexation of metals to humic substances	U.S. Department of Agriculture
Chaney RL	Beltsville Agricultural Research Center	Characterization and remediation of potential trace element and phosphate risks from contaminated soils	U.S. Department of Agriculture
Chaney RL	Beltsville Agricultural Research Center	Risk assessment and remediation of soil and amendment trace elements	U.S. Department of Agriculture

6. POTENTIAL FOR HUMAN EXPOSURE

Table 6-10. Ongoing Studies on Cadmium

Investigator	Affiliation	Research description	Sponsor
Chaney RL; Daniels WL	Virginia Polytechnic Institute	Effects of long-term biosolids applications on phytoavailability of soil cadmium and zinc	U.S. Department of Agriculture
Chang AC; Page AL	University of California, Riverside	Chemistry and bioavailability of waste constituents in soils	U.S. Department of Agriculture
Eick MJ	Virginia Polytechnic Institute	Trace element and ligand adsorption/ desorption from soil constituent surfaces	U.S. Department of Agriculture
Hopkins DG	North Dakota State University	Influence of geologic materials and pedogenic processes on trace elements in soil landscapes	U.S. Department of Agriculture
Hunt JR; Lykken GI	University of North Dakota	Whole body counting and radiotracer methods in research on mineral requirements in human nutrition	U.S. Department of Agriculture
Kpomblekou- Ademawou K; Ankumah RO	Tuskegee University	Trace elements in broiler littered soils: Fate and effects on nitrogen transformation	U.S. Department of Agriculture
Martinez CE	Pennsylvania State University	Chemical and biogeochemical processes involved in trace and toxic element cycling in soils	U.S. Department of Agriculture
Morrissey MT	Oregon State University	Characterization of the cadmium health risk, concentrations and ways to minimize cadmium residues in shellfish	U.S. Department of Agriculture
Schwab AP; Joern B; Johnston C	Purdue University	Chemistry and bioavailability of waste constituents in soils	U.S. Department of Agriculture
Sparks DL	University of Delaware	Rates and mechanisms of metal and metalloid sorption/surfaces	U.S. Department of Agriculture
Thomas, DG; Kennedy TS	Oklahoma State University	Maternal dietary nutrients and neurotoxins in infant cognitive development	U.S. Department of Agriculture
Williams PL	University of Georgia	Environmental health impacts of soil contamination	U.S. Department of Agriculture
	National Risk Management Research Laboratory	Biomonitoring of source water quality	U.S. Environmental Protection Agency
Petterson L	National Exposure Research Lab Environmental Sciences Division Characterization and Monitoring Branch	Efficient monitoring of heterogeneous media and electronic wastes	U.S. Environmental Protection Agency

6. POTENTIAL FOR HUMAN EXPOSURE

Table 6-10. Ongoing Studies on Cadmium

Investigator	Affiliation	Research description	Sponsor
Petterson L	National Exposure Research Lab Ecosystems Research Division Ecosystems Assessment Branch	Geochemical and interfacial applications for assessing ecological toxicant exposures	U.S. Environmental Protection Agency
Nolan P	Office of Regional Administrator Office of Environmental Measurement and Evaluation	Lower Merrimack River fish tissue study	U.S. Environmental Protection Agency
Janes D	Office of Research and Development National Health and Environmental Effects Research Lab Mid-Continent Ecology Division	Risks of heavy metals to aquatic organisms from multiple exposure routes	U.S. Environmental Protection Agency

Sources: FEDRIP 2008; SI/EPA 2007

6. POTENTIAL FOR HUMAN EXPOSURE

This page is intentionally blank.

7. ANALYTICAL METHODS

The purpose of this chapter is to describe the analytical methods that are available for detecting, measuring, and/or monitoring cadmium, its metabolites, and other biomarkers of exposure and effect to cadmium. The intent is not to provide an exhaustive list of analytical methods. Rather, the intention is to identify well-established methods that are used as the standard methods of analysis. Many of the analytical methods used for environmental samples are the methods approved by federal agencies and organizations such as EPA and the National Institute for Occupational Safety and Health (NIOSH). Other methods presented in this chapter are those that are approved by groups such as the Association of Official Analytical Chemists (AOAC) and the American Public Health Association (APHA). Additionally, analytical methods are included that modify previously used methods to obtain lower detection limits and/or to improve accuracy and precision.

7.1 BIOLOGICAL MATERIALS

The most common analytical procedures for measuring cadmium concentrations in biological samples use the methods of atomic absorption spectroscopy (AAS) and inductively coupled plasma atomic emission spectroscopy (ICP/AES). These basic methods of analysis are well defined and generally accepted for the analysis of cadmium.

Samples are prepared for AAS and ICP/AES methods in a variety of ways. Digestion with nitric acid is most common (Roberts and Clark 1986; Sharma et al. 1982). Cadmium in blood and plasma measured by graphite furnace atomic absorption spectroscopy (GFAAS) facilitated by a wet ashing pretreatment of samples resulted in good accuracy and reproducibility. The sample detection limit using this method was 0.4 $\mu\text{g/L}$ (Roberts and Clark 1986). This method was also precise and highly reproducible in determining cadmium in whole blood, urine, and hair with 99–99.4% recoveries reported (Sharma et al. 1982). The matrix may also be modified with diammonium hydrogen phosphate or other agents such as palladium (Pd)-based modifiers (Moreira et al. 1995). Detection limits as low as 0.1 $\mu\text{g/L}$ with recoveries ranging from 93 to 111% are reported using this technique (Subramanian and Meranger 1981; Subramanian et al. 1983). If the concentration of cadmium in the dissolved sample is below the detection limit, preconcentration techniques, such as chelation and extraction, may be employed (Gross et al. 1976; Sharma et al. 1982). Various ICP methods have been developed for measuring cadmium levels in biological materials. ICP dynamic reaction cell mass spectrometry (ICP-DRC-MS) has been shown to eliminate molybdenum-based polyatomic interferences, resulting in a reduction of observed urine cadmium concentrations, as compared to ICP-MS measurements (Jarrett et al. 2008). Since cadmium is a

7. ANALYTICAL METHODS

ubiquitous element, the risk of contamination during sampling, processing, and analysis must be minimized by strict laboratory procedures (Elinder and Lind 1985). In procedures for micro-determination, all glass and plastic-ware should be acid-washed and subsequently rinsed with double-distilled water.

Current analytical improvements deal primarily with the methods of sample preparation and sample introduction to the analytical systems in order to lower the detection limits or decrease sample analysis time. Various improvements in the methods of extraction, preconcentration, chelation, complexation, and sample introduction have been developed for use with biological media. Detection limits as low as 0.003 µg/L were reported (Espinosa Almendro et al. 1992; Cordero et al. 1994; Jeng et al. 1994; Katskov et al. 1994; Komárek et al. 1991; Ma et al. 1994b; Welz et al. 1991).

The cadmium concentration in biological samples may also be measured by a number of other methods such as radiochemical neutron activation analysis (RNAA). One RNAA procedure involving a rapid two-step solvent extraction was used for determining cadmium in tissue samples (Tandon et al. 1994). Another method to determine cadmium in biological materials is based on the ion-exchange scheme developed by SAMSAHL where cadmium is trapped on an anion exchange resin. With this method, recovery of 98% and a detection limit of 4 µg/kg were reported. The accuracy of the method was estimated by three different approaches: analysis using radiotracers in inactive sample solutions; by analyzing standards, pipetted on filter paper, and processed as samples; and determination by RNAA (Woittiez and Tangonan 1992).

Cadmium concentration in tissue may be measured both *in vivo* (Ellis 1985; Scott and Chettle 1986) and *in vitro* (Lieberman and Kramer 1970) by neutron activation analysis (NAA). Direct *in vivo* assessment of body burden in humans focused on the measurements of cadmium in the kidney and liver by NAA. The detection limits reported are approximately 2 mg cadmium for the total kidney and 1.5 µg/g for the liver (Ellis 1985); 1.9 mg cadmium for the kidney; and 1.3 µg/g for the liver (Scott and Chettle 1986).

X-ray fluorescence is also used for *in vivo* measurement of cadmium in the kidney (Christoffersson et al. 1987; Nilsson and Skerfving 1993; Scott and Chettle 1986; Skerfving and Nilsson 1992). The *in vivo* techniques are used for clinical measurements of individuals occupationally exposed to cadmium. Additional methods applicable to the analysis of cadmium in biological media include ICP/MS (Stroh 1993; Vanhoe et al. 1994), ICP/AES (Cordero et al. 1994; Espinosa Almendro et al. 1992), and high performance liquid chromatography (HPLC) (Chang and Robinson 1993; Steenkamp and Coetzee 1994).

7. ANALYTICAL METHODS

Electrothermal vaporization ICP/MS has been utilized for the analysis of dentin and enamel from teeth (Grünke et al. 1996). Electrochemical methods such as adsorptive cathodic stripping voltametry (ACSV) and potentiometric stripping analysis (PSA) have been applied to hair analysis (Zhang et al. 1993), animal tissues (LaBar and Lamberts 1994), and body fluids (Ostapczuk 1993).

Table 7-1 summarizes some of the methods used for sample preparation and analysis of cadmium in biological samples.

7.2 ENVIRONMENTAL SAMPLES

Analysis for cadmium in environmental samples is usually accomplished by AAS or AES techniques, with samples prepared by digestion with acid, preconcentrated with a chelating resin, or direct aspiration with no preparation (APHA 1977a, 1977b; EPA 1983a, 1983b, 1997b; OSHA 2002a, 2004; USGS 1985). Since cadmium in air is usually associated with particulate matter, standard methods involve collection of air samples on glass fiber or membrane filters, acid extraction of the filters, and subsequent analysis (APHA 1977a, 1977b; OSHA 2002a, 2002b). Inductively-coupled plasma spectrometry (ICP) analysis in standard methods is also popular. ICP analysis for water and air samples can be run in tandem with mass spectrometry (MS) or AES (EPA 1996b, 1997b, 2003; NIOSH 2003; OSHA 2002b). ACSV (Nimmo and Fones 1994), differential pulse anodic stripping voltametry (DP-ASV) (Nam et al. 1994), and epidermal NAA (Landsberger and Wu 1993) have also been used for air analysis. The accuracy of the analysis of cadmium in acid digested atmospheric samples, measured by ACSV, was evaluated and compared with GFAAS and ICP/MS.

Several methods standardized by EPA (1983a, 1983b, 1994b, 1996a, 1996b, 1997b, 2000, 2003) are used for measuring concentrations of cadmium in water. Techniques to compensate for chemical and matrix interferences in all three methods are described by EPA (1983a, 1983b, 1994b, 1996a, 1996b, 1997b, 2000, 2003). After soils and solid wastes are extracted or solubilized by acid digestion, they may be analyzed for cadmium by the same AAS methods that are used for water (EPA 1986d, 1986e). Water can also be analyzed for cadmium by NAA methods (Saleh et al. 1993), PSA methods (Ostapczuk 1993), and anodic stripping voltametry (ASV) (Daih and Huang 1992).

Sediment and soil samples have been analyzed for cadmium using the methods of GFAAS (Klemm and Bombach 1995). Preparation of the samples is generally accomplished by treatment with HCl and HNO₃.

7. ANALYTICAL METHODS

Table 7-1. Analytical Methods for Determining Cadmium in Biological Materials

Sample matrix	Preparation method	Analytical method	Sample detection limit	Percent recovery	Reference
Blood	Digestion with nitric acid; chelation with APDC and extraction with MIBK	AAS	<1 ng/mL ^a	99	Sharma et al. 1982
Blood	Modification of matrix with diammonium hydrogen phosphate/Triton X-100	GFAAS	0.1 µg/L	100.8±4.3	Subramanian and Meranger 1981
Blood/plasma	Digestion with nitric acid; wet ashed	GFAAS	0.4 µg/L	No data	Roberts and Clark 1986
Serum	Dilution with ammonia/Triton X-100	ICP/MS	0.01 ng/mL	No data	Stroh 1993
Tissue and blood	Microwave digestion	FAAS/flow injection system	0.15 µg/L	No data	Welz et al. 1991
Human milk	Dilution with deionized and double distilled water	AAS	<0.01 ppb ^a	No data	Schulte-Lobbert and Bohn 1977
Hair	Digestion with nitric acid	AAS	0.07 µg/g ^a	99	Sharma et al. 1982
Kidney	None (<i>in vivo</i>)	XRF	170.1 µg/g	No data	Christoffersson et al. 1987
Kidney/liver	Chelation and extraction with solvent	AAS/direct aspiration	0.01 ppm ^a (liver) 1.9 mg (kidney)	No data	Gross et al. 1976
Kidney/liver	None (<i>in vivo</i>)	NAA	1.3 µg/g (liver) 1.9 mg (kidney)	No data	Scott and Chettle 1986
Muscle	Wet ashed with concentrated sulfuric acid	NAA	50 ppb	50–65	Lieberman and Kramer 1970
Urine	Dilution with nitric acid	ETAAS	0.045 µg/L	97–101	Komárek et al. 1991
Urine	Modification of matrix with diammonium hydrogen phosphate/nitric acid	GFAAS	0.09 ng/mL	92.7–111.1	Subramanian et al. 1983
Urine	Digestion with nitric acid	AAS	5.67 ng/mL ^a	99.4	Sharma et al. 1982
Biological materials	Microwave digestion followed by extraction with APTH in MIBK	ICP/AES	0.15 ng/mL	No data	Cordero et al. 1994
Biological materials	Extraction with 1,5-bis(di-2-pyridylmethylene) thiocarbonohydrazide in MIBK	ICP/AES	0.1 ng/mL	No data	Espinosa Almendro et al. 1992

7. ANALYTICAL METHODS

Table 7-1. Analytical Methods for Determining Cadmium in Biological Materials

Sample matrix	Preparation method	Analytical method	Sample detection limit	Percent recovery	Reference
Biological materials	Digestion with acid	GFAAS/flow injection system	0.003 µg/L	No data	Ma et al. 1994a
Biological fluids (blood, urine)	Acidification	PSA	0.001 µg/kg	No data	Ostapczuk 1993
Biological materials	Dry tissues; irradiation followed by acid digestion	RNAA	4 µg/kg	98	Woittiez et al. 1992
Teeth, dentin, and enamel	Digested in nitric acid, diluted with water	ETV-ICP-MS PN-ICP-MS	No data	No data	Grünke et al. 1996
Whole blood, urine	Modified with palladium based modifier	ETAAS	0.22 µg/L	No data	Moreira et al. 1995
Biological materials	Digested with nitric acid and hydrogen peroxide	B-9001-95; ICP-AES	No data	93	USGS 1996

^aLowest concentration found

AAS = atomic absorption spectroscopy; APDC = ammonium pyrrolidenedithiocarbamate; APTH = 1,3-bis-[1-(2-pyridyl)ethylidene] thiocarbon-hydride; ETAAS = electrothermal atomic absorption spectroscopy; FAAS = flame atomic absorption; GFAAS = graphite furnace atomic absorption; ICP/AES = inductively coupled plasma atomic emission spectroscopy; ICP/MS = inductively coupled plasma mass spectrometry; MIBK = methyl isobutyl ketone; NAA = neutron activation analysis; PSA = potentiometric stripping analysis; RNAA = radio chemical neutron activation analysis; XRF = x-ray fluorescence

7. ANALYTICAL METHODS

The most common method for analysis of cadmium in foods is AAS (Bruhn and Franke 1976; Dabeka 1979; Muys 1984), with GFAAS being one of the most common AAS methods used (Cabrera et al. 1995). The FDA's Total Diet Study 1991–1996 analyzed cadmium and other element concentrations in food by dry ash mineralization and GFAAS (Capar and Cunningham 2000). RNAA (Greenberg et al. 1979), differential pulse ASV (Satzger et al. 1982, 1984), and the calorimetric dithizone method (AOAC 1984) may also be employed. The AAS techniques appear to be most sensitive, with recoveries ranging from 94 to 109% (Bruhn and Franke 1976; Muys 1984). A method used to isolate cadmium by first extracting with bismuth diethyldithiocarbamate (Bi[DDC]₃) and then with zinc diethyldithiocarbamate (Zn[DDC]₂) in chloroform and then measuring by RNAA showed 94–106% recovery (Greenberg et al. 1979).

Table 7-2 summarizes some of the methods used for sample preparation and analysis of cadmium in environmental samples.

7.3 ADEQUACY OF THE DATABASE

Section 104(i)(5) of CERCLA, as amended, directs the Administrator of ATSDR (in consultation with the Administrator of EPA and agencies and programs of the Public Health Service) to assess whether adequate information on the health effects of cadmium is available. Where adequate information is not available, ATSDR, in conjunction with NTP, is required to assure the initiation of a program of research designed to determine the health effects (and techniques for developing methods to determine such health effects) of cadmium.

The following categories of possible data needs have been identified by a joint team of scientists from ATSDR, NTP, and EPA. They are defined as substance-specific informational needs that if met would reduce the uncertainties of human health assessment. This definition should not be interpreted to mean that all data needs discussed in this section must be filled. In the future, the identified data needs will be evaluated and prioritized, and a substance-specific research agenda will be proposed.

7.3.1 Identification of Data Needs

Methods for Determining Biomarkers of Exposure and Effect.

Exposure. Measurements of cadmium in liver and kidney are all useful biological indices for human exposure to cadmium (Roels et al. 1981b). Human milk, human placentas, and maternal and neonatal

7. ANALYTICAL METHODS

Table 7-2. Analytical Methods for Determining Cadmium in Environmental Samples

Sample matrix	Preparation method	Analytical method	Sample detection limit	Percent recovery	Reference
Air	Collection on glass fiber filter; ashed with hydrochloric and nitric acids	Method 311; AAS	0.005 $\mu\text{g}/\text{m}^3$	90	APHA 1977b
Air	Collection on membrane filter; ashed with hydrochloric and nitric acids	Method 7048; AAS	0.05 μg per sample	No data	NIOSH 1994
Air	Collection on membrane filter; digestion with nitric acid and perchloric acid	Method 7300; ICP	0.3 ng/mL	99.8–105.2	NIOSH 2003
Air	Collection using filters, wipes, or bulk materials; desorbed with water extractions and mineral acid digestions	Method 121; AAS/AES	0.004 $\mu\text{g}/\text{mL}$	99.5	OSHA 2002a
Air	Collection on membrane filter; digested in nitric acid, sulfuric acid, and hydrogen peroxide	Method 125G; ICP-AES	0.14 μg^{a} 0.47 μg^{b}	No data	OSHA 2002b
Air	Collection on membrane filter; digested with nitric acid and small amounts of hydrochloric acid	Method 189; AAS/AAS-HGA	0.2 $\mu\text{g}/\text{m}^3$ (AAS) ^a 0.70 $\mu\text{g}/\text{m}^3$ (AAS) ^b 0.007 $\mu\text{g}/\text{m}^3$ (AAS-HGA) ^a 0.025 $\mu\text{g}/\text{m}^3$ (AAS-HGA) ^b	No data	OSHA 2004
Air	Collection on membrane filter, wipe, or bulk material; digest with nitric and hydrochloric acids	Method 206; ICP-AES	0.0062 $\mu\text{g}/\text{mL}^{\text{a}}$ 0.0205 $\mu\text{g}/\text{mL}^{\text{b}}$	No data	OSHA 1991
Air	Irradiation UF filters	Epithermal NAA	8 ng	No data	Landsberger et al. 1993
Air (aerosols)	Acid digestion with filters	ACSV	0.6 ng/mL	100	Nimmo and Fones 1994
Atmospheric particles	Direct analysis	ETV-ICP-MS	pg/m^3 range	No data	Lüdke et al. 1997
Water	Digestion with nitric acid	Method 213.1; AAS/direct aspiration	5 $\mu\text{g}/\text{L}$	94±24	EPA 1983a
Water	Digestion with nitric acid	Method 213.2; AAS/GFAAS	0.1 $\mu\text{g}/\text{L}$	96–99	EPA 1983b

7. ANALYTICAL METHODS

Table 7-2. Analytical Methods for Determining Cadmium in Environmental Samples

Sample matrix	Preparation method	Analytical method	Sample detection limit	Percent recovery	Reference
Water	On-line preconcentration with ion exchange or sorbent extraction columns	GFAAS/ flow injection system	0.8 ng/L	No data	Welz et al. 1992
Water	Digestion with nitric acid	Method 1637; chelation and GFAAS	0.0075 µg/L	No data	EPA 1996a
Water	Digestion with nitric acid	Method 1638; ICP-MS	0.025 µg/L	No data	EPA 1996b
Water	Preconcentrated with chelating resin	Method 1640; Online Chelation/ ICP-MS	0.0024 µg/L	No data	EPA 1997b
Water	Digested with hydrochloric and nitric acids	Method 200.5; AVICP-AES	0.1 µg/L	98±1.1	EPA 2003
Water and Wastes	Digestion with acids	Method 200.7; ICP-AES	1 µg/L (aqueous); 0.2 mg/kg (solids)	82–98	EPA 1994a
Various	Digestion with nitric and hydrochloric acids	Method 6010C; ICP-AES	No data	97	EPA 2000
Water and sediments	No preconcentration or pretreatment	I-1135; AAS	10 µg/L	No data	USGS 1985
Water	Digested with whole water	I-4471-97; ICP-OES	5 µg/L	No data	USGS 1998a
Various	Direct aspiration with no preconcentration or pretreatment	I-5135; AAS	10 µg/L	No data	USGS 1985
Soil	Digestion with nitric acid	Method 7130; AAS/direct aspiration	0.005 mg/L	No data	EPA 1986e
Soil	Digestion with nitric acid	Method 7131; GFAAS	0.1 µg/L	No data	EPA 1986d
Soil and sediment	Ultrasonic slurry in dilute nitric acid	GFAAS	No data	100±10	Klemm and Bombach 1995

7. ANALYTICAL METHODS

Table 7-2. Analytical Methods for Determining Cadmium in Environmental Samples

Sample matrix	Preparation method	Analytical method	Sample detection limit	Percent recovery	Reference
Sediment	Digestion with hydrochloric and nitric acid	LEAFS	500 fg	No data	Zhou et al. 1998
Soil and sediment	Digestion with hydrofluoric acid and nitric acid; complexation with DDPA using on-line sorbent extraction system	GFAAS/ flow injection system	0.8 µg/L	No data	Ma et al. 1994b
Food	Dry ashed; oxidization with nitric acid	ASV/ differential pulse	1 ng/g	99–108	Satzger et al. 1984
Food	Dry ashed; complexation with APCD; extraction with isoamyl acetate	AAS	0.1 ng/g	97.5±2.5	Bruhn and Franke 1976
Food	Extraction with Bi(DDC) ₃ then with Zn(DDC) ₂ in chloroform	RNAA	0.029 µg/g ^c	94–106	Greenberg et al. 1979
Food (24 hour diet)	Microwave digestion with nitric acid and hydrogen peroxide	GFAAS	0.004 µg/g	94–101	Yang et al. 1995
Food	Dry ashed; complexation with NaDDTC; extraction with IBMK	GFAAS	0.1 ppb ^c	94–109	Muys 1984
Food	Homogenization followed by wet ashing	GFAAS	0.01 ppb	94–108	Zhang et al. 1997
Fruit	Homogenized fruit slurried with zirconia	ETAAS	0.3 ng/g	97.7±0.3	Cabrera et al. 1995

^aQualitative detection limit^bQuantitative detection limit^cLowest concentration found

AAS = atomic absorption spectroscopy; ACSV = adsorptive cathodic stripping voltametry; APCD = ammonium pyrrolidino carbodithioate; ASV = anodic stripping voltametry; AVICP-AES = axially viewed inductively coupled plasma-atomic emission spectrometry; Bi(DDC)₃ = bismuth diethyldithiocarbamate; DDPA = ammonium diethyldithiophosphate; ETV-ICP-MS = electrothermal vaporization inductively coupled plasma mass spectrometry; GFAAS = graphite furnace atomic absorption; HGA = heated graphite atomizer; IBMK = isobutyl methyl ketone; ICP = inductively coupled plasma; LEAFS = laser-excited atomic fluorescence spectrometry; MS = mass spectrometry; NAA = neutron activation analysis; NaDDTC = sodiumdiethyl-dithiocarbamate; OES = optical emission spectroscopy; RNAA = radiochemical neutron activation analysis; Zn(DDC)₂ = zinc diethyldithiocarbamate

7. ANALYTICAL METHODS

blood have been investigated as means to determine exposures of women and infants to cadmium (Baranowska 1995; Abadin et al. 1997). Sensitive and selective methods are available for the detection and quantitation of cadmium in these biological materials (Elinder and Lind 1985; Sharma et al. 1982). Improved methods for sample preparation and *in vivo* analysis of liver and kidney content are needed to assist in monitoring environmentally exposed populations.

Effect. Sensitive methods are also available for measuring biological markers of cadmium effect, particularly urine or serum concentration of β 2-microglobulin, retinol-binding protein, metallothionein, and creatinine (Kawada et al. 1990; Roels et al. 1989; Topping et al. 1986).

Methods for Determining Parent Compounds and Degradation Products in Environmental

Media. Cadmium is ubiquitous in the environment and does not degrade. It is found in air, water, soil, sediments, and food. Analytical methods exist for the analysis of cadmium in all of these environmental media, and these methods have the sensitivity to measure background levels and detect elevated concentrations due to anthropogenic sources such as hazardous waste sites (EPA 1983a, 1983b, 1994b, 1996a, 1996b, 1997b, 2000, 2003). Additional research to reduce chemical and matrix interferences are needed to improve the speed and accuracy of the analyses.

7.3.2 Ongoing Studies

The National Report on Human Health Exposure to Environmental Chemicals is an ongoing biomonitoring assessment conducted by CDC. This survey measures over 200 chemicals in blood and urine from random samples collected from participants in the National Health and Nutrition Examination Survey (NHANES). The National Exposure Report was last published in 2009 and an update of biomonitoring levels for some of the chemicals, including cadmium, was published in 2012 (CDC 2012).

The information in [Table 7-3](#) was found as a result of a search of the Federal Research in Progress database (FEDRIP 2008).

7. ANALYTICAL METHODS

Table 7-3. Ongoing Analytical Methods Studies on Cadmium

Investigator	Affiliation	Research description	Sponsor
Parker D	University of California	Isotopic dilution methods for probing the bioavailability of trace elements in soils and sediments	U.S. Department of Agriculture
Pierzynski G	Kansas State University	Chemistry, bioavailability, and toxicity of constituents in residuals and residual treated soils	U.S. Department of Agriculture
Schwab AP; Joern B; Johnston C	Purdue University	Chemistry and bioavailability of waste constituents in soils	U.S. Department of Agriculture
Santra S	University of Central Florida	Selective detection of toxic heavy metal ions using highly sensitive quantum dot probes	National Science Foundation
Swain G	Michigan State University	Diamond microelectrode arrays: New materials for the electrochemical detection of aqueous analytes	U.S. Department of Agriculture

Source: FEDRIP 2008

7. ANALYTICAL METHODS

This page is intentionally blank.

8. REGULATIONS, ADVISORIES, AND GUIDELINES

MRLs are substance-specific estimates, which are intended to serve as screening levels, are used by ATSDR health assessors and other responders to identify contaminants and potential health effects that may be of concern at hazardous waste sites.

ATSDR has derived an acute-duration inhalation MRL of $0.03 \mu\text{g Cd/m}^3$ for cadmium. This MRL is based on a LOAEL of 0.088 mg Cd/m^3 (LOAEL_{HEC} of 0.01 mg Cd/m^3) for respiratory effects in rats exposed to cadmium oxide 6.2 hours/day, 5 days/week for 2 weeks (NTP 1995) and an uncertainty factor of 300 (10 for the use of a LOAEL, 3 for extrapolation from animals to humans with dosimetric adjustments, and 10 for human variability).

ATSDR has derived a chronic-duration inhalation MRL of $0.01 \mu\text{g Cd/m}^3$ for cadmium. This MRL is based on the 95% lower confidence limit of the urinary cadmium level associated with a 10% extra risk of low molecular weight proteinuria (UCDL₁₀) estimated from a meta-analysis of environmental exposure data. An air concentration that would result in this urinary cadmium level ($0.5 \mu\text{g/g creatinine}$), assuming a dietary cadmium intake of $0.3 \mu\text{g/kg/day}$, was estimated using biokinetic models. The estimated air concentration of $0.1 \mu\text{g Cd/m}^3$ was divided by an uncertainty factor of 3 for human variability and a modifying factor of 3.

The EPA has not established a reference concentration (RfC) for cadmium.

ATSDR has derived an intermediate-duration oral MRL of $0.5 \mu\text{g Cd/kg/day}$ for cadmium. This MRL is based on a BMDL_{std1} of $0.05 \text{ mg Cd/kg/day}$ for skeletal effects in young female rats exposed to cadmium chloride in drinking water for 6, 9, or 12 months (Brzóška and Moniuszko-Jakoniuk 2005d) and an uncertainty factor of 100 (10 for extrapolation from animals to humans and 10 for human variability).

ATSDR has derived a chronic-duration oral MRL of $0.1 \mu\text{g Cd/kg/day}$ for cadmium. This MRL is based on the UCDL₁₀ for low molecular weight proteinuria estimated from a meta-analysis of environmental exposure data. A cadmium intake that would result in the UCDL₁₀ ($0.5 \mu\text{g/g creatinine}$) at age 55 was estimated using pharmacokinetic models. The cadmium intake of $0.33 \mu\text{g/kg/day}$ was divided by an uncertainty factor of 3 for human variability.

8. REGULATIONS, ADVISORIES, AND GUIDELINES

The EPA has established a reference dose (RfD) of 5×10^{-4} mg/kg/day in water and 1×10^{-3} mg/kg/day in food (IRIS 2012). The RfD is based on a chronic intake that would result in a kidney concentration of 200 $\mu\text{g/g}$ ww.

The international and national regulations, advisories, and guidelines regarding cadmium in air, water, and other media are summarized in [Table 8-1](#).

Cadmium compounds are included on the list of 189 chemicals listed as hazardous air pollutants under Section 112 of the Clean Air Act as amended (EPA 2007). Cadmium also is on the list of chemicals appearing in the Emergency Planning and Community Right-To-Know Act of 1986 (EPA 2008g). Under Title III of this statute, owners and operators of facilities that manufacture, import, process, or otherwise use the chemicals on this list of report annually their release of those chemicals to any environmental media.

Cadmium and cadmium chloride are designed as hazardous substances under Section 311 of the Clean Water Act; any discharge of these chemicals over a specified threshold level into navigable waters is subject to reporting requirements (EPA 2008c).

Cadmium is a hazardous waste under the Resource Conservation and Recovery Act (RCRA) under several circumstances. Groundwater monitoring is required at municipal solid waste landfills (EPA 2008d) and cadmium is considered a priority persistent, bioaccumulative, and toxic (PBT) chemical under RCRA waste minimization chemical listing (EPA 1998).

8. REGULATIONS, ADVISORIES, AND GUIDELINES

Table 8-1. Regulations, Advisories, and Guidelines Applicable to Cadmium

Agency	Description	Information	Reference
<u>INTERNATIONAL</u>			
Guidelines:			
IARC	Carcinogenicity classification Cadmium and cadmium compounds	Group 1 ^a	IARC 2008
WHO	Air quality guidelines Cadmium ^{b,c}	5 ng/m ³	WHO 2000
	Drinking water quality guidelines Cadmium	0.003 mg/L	WHO 2004
<u>NATIONAL</u>			
Regulations and Guidelines:			
a. Air			
ACGIH	Biological exposure indices Cadmium and inorganic compounds Cadmium in urine Cadmium in blood	5 µg/g creatinine 5 µg/L	ACGIH 2007
	TLV (8-hour TWA) Cadmium	0.01 mg/m ³	
	Hazardous air pollutant Cadmium compounds	Yes	EPA 2007 42 USC 7412
NIOSH	REL (10-hour TWA) Cadmium ^f Cadmium oxide	Potential occupational carcinogens Potential occupational carcinogens	NIOSH 2005
	IDLH Cadmium (as Cd) Cadmium oxide (as Cd)	9 mg/m ³ 9 mg/m ³	
	Category of pesticides Cadmium carbonate Cadmium chloride Cadmium sulfate	Group II pesticide ^g Group I pesticide ^h Group II pesticide ^g	NIOSH 1992b

8. REGULATIONS, ADVISORIES, AND GUIDELINES

Table 8-1. Regulations, Advisories, and Guidelines Applicable to Cadmium

Agency	Description	Information	Reference
<u>NATIONAL</u> (cont.)			
OSHA	PEL (8-hour TWA) for general industry Cadmium (as Cd)	5 µg/m ³	OSHA 2007a 29 CFR 1910.1027
	PEL (8-hour TWA) for shipyard industry Cadmium (as Cd)	5 µg/m ³	OSHA 2007b 29 CFR 1915.1027
	PEL (8-hour TWA) for construction industry Cadmium (as Cd)	5 µg/m ³	OSHA 2007c 29 CFR 1926.1127
b. Water			
EPA	Designated as hazardous substances in accordance with Section 311(b)(2)(A) of the Clean Water Act		EPA 2008b 40 CFR 116.4
	Cadmium chloride	Yes	
	Drinking water standards and health advisories		EPA 2011b
	Cadmium		
	1-day health advisory for a 10-kg child	0.04 mg/L	
	10-day health advisory for a 10-kg child	0.04 mg/L	
	DWEL	0.02 mg/L	
	Lifetime	0.005 mg/L	
	National primary drinking water standards		EPA 2009b
	Cadmium		
MCL	0.005 mg/L		
Public health goal	0.005 mg/L		
Reportable quantities of hazardous substances designated pursuant to Section 311 of the Clean Water Act			EPA 2008c 40 CFR 117.3
Cadmium chloride	10 pounds		
Toxic pollutants designated pursuant to Section 307(a)(1) of the Clean Water Act			EPA 2008h 40 CFR 401.15
Cadmium and compounds	Yes		
c. Food			
FDA	Bottled drinking water Cadmium	0.005 mg/L	FDA 2007 21 CFR 165.110
	EAFUS	No data	FDA 2008

8. REGULATIONS, ADVISORIES, AND GUIDELINES

Table 8-1. Regulations, Advisories, and Guidelines Applicable to Cadmium

Agency	Description	Information	Reference	
<u>NATIONAL</u> (cont.)				
d. Other				
ACGIH	Carcinogenicity classification		ACGIH 2007	
	Cadmium	A2 ^j		
	Cadmium compounds (as Cd)	A2 ^j		
EPA	Carcinogenicity classification		IRIS 2012	
	Cadmium	Group B1 ^k		
	Inhalation unit risk			
	Cadmium	1.8x10 ⁻³ per µg/m ³		
	RfC			
	Cadmium	No data		
	RfD			
	Cadmium			
	Food	1x10 ⁻³ mg/kg-day		
	Water	5x10 ⁻⁴ mg/kg-day		
	RCRA waste minimization PBT priority chemical list			EPA 1998 63 FR 60332
	Cadmium	Yes		
	Standards for owners and operators of hazardous waste TSD facilities; groundwater monitoring list			EPA 2008d 40 CFR 264, Appendix IX
	Cadmium	Yes		
	Superfund, emergency planning, and community right-to-know			
Designated CERCLA hazardous substance		EPA 2008e 40 CFR 302.4		
Cadmium	Yes ^{l,m}			
Cadmium and compounds	Yes ⁿ			
Cadmium chloride	Yes ^o			
Reportable quantity				
Cadmium	10 pounds			
Cadmium and compounds	None ^p			
Cadmium chloride	10 pounds			

8. REGULATIONS, ADVISORIES, AND GUIDELINES

Table 8-1. Regulations, Advisories, and Guidelines Applicable to Cadmium

Agency	Description	Information	Reference
NATIONAL (cont.)			
EPA	Superfund, emergency planning, and community right-to-know		
	Effective date of toxic chemical release reporting		EPA 2008g 40 CFR 372.65
	Cadmium	01/01/1987	
	Cadmium compounds ^q	01/01/1987	
	Extremely Hazardous Substances		EPA 2008f 40 CFR 355, Appendix A
	Cadmium oxide		
	Reportable quantity	100 pounds	
	Threshold planning quantity	100/10,000 pounds	
NTP	Carcinogenicity classification		NTP 2011
	Cadmium and cadmium compounds	Known to be human carcinogens	

^aGroup 1: The agent is carcinogenic to humans.

^bThe guideline value is based on the prevention of a further increase of cadmium in agricultural soils, which is likely to increase the dietary intake.

^cTWA based on effects other than cancer or odor/annoyance using an averaging time of 1 year.

^dRespirable fraction.

^eHigher current priority chemical for guideline development.

^fREL applies to all cadmium compounds (as Cd).

^gGroup II pesticide: Contains the pesticides that pose as significant risk of carcinogenic, teratogenic, neurotoxic, or reproductive effects

^hGroup I pesticide: Contains the pesticides that pose as significant risk of adverse acute health effects at low concentrations

ⁱThe CMC is an estimate of the highest concentration of a material in surface water to which an aquatic community can be exposed briefly without resulting in an unacceptable effect. The CCC is an estimate of the highest concentration of a material in surface water to which an aquatic community can be exposed indefinitely without resulting in an unacceptable effect.

^jA2: Suspected human carcinogen.

^kGroup B1: Probable human carcinogen based on limited evidence of carcinogenicity in humans.

^lDesignated CERCLA hazardous substance pursuant to Section 307(a) of the Clean Water Act.

^mNo reporting of releases of this hazardous substance is required if the diameter of the pieces of the solid metal released is larger than 100 micrometers (0.004 inches).

ⁿDesignated CERCLA hazardous substance pursuant to Section 307(a) of the Clean Water Act and Section 112 of the Clean Air Act.

^oDesignated CERCLA hazardous substance pursuant to Section 311(b)(2) of the Clean Water Act.

^pIndicates that no reportable quantity is being assigned to the generic or broad class.

^qCadmium compounds: Includes any unique chemical substance that contains cadmium as part of that chemical's infrastructure.

ACGIH = American Conference of Governmental Industrial Hygienists; AEGL = acute exposure guideline levels; CCC = Criterion Continuous Concentration; CERCLA = Comprehensive Environmental Response, Compensation, and Liability Act; CFR = Code of Federal Regulations; CMC = Criteria Maximum Concentration; DWEL = drinking water equivalent level; EAFUS = Everything Added to Food in the United States; EPA = Environmental Protection Agency; FDA = Food and Drug Administration; IARC = International Agency for Research on Cancer; IDLH = immediately dangerous to life or health; IRIS = Integrated Risk Information System; MCL = maximum contaminant level; NIOSH = National Institute for Occupational Safety and Health; NTP = National Toxicology Program; OSHA = Occupational Safety and Health Administration; PBT = persistent, bioaccumulative, and toxic; PEL = permissible exposure limit; RCRA = Resource Conservation and Recovery Act; REL = recommended exposure limit; RfC = inhalation reference concentration; RfD = oral reference dose; TLV = threshold limit values; TSD = treatment, storage, and disposal; TWA = time-weighted average; USC = United States Code; WHO = World Health Organization

9. REFERENCES

- Abadin HG, Hibbs BF, Pohl HR. 1997. Breast-feeding exposures of infants to cadmium, lead, and mercury: A public health viewpoint. *Toxicol Ind Health* 13(4):495-517.
- Abdel-Saheb I, Schwab AP, Banks MK, et al. 1994. Chemical characterization of heavy metal contaminated soil in southeast Kansas. *Water Air Soil Pollut* 78:73-82.
- Abraham KS, Abdel-Gawad NB, Mahmoud AM, et al. 2011. Genotoxic effect of occupational exposure to cadmium. *Toxicol Ind Health* 27(2):173-179.
- ACGIH. 2007. Cadmium. Threshold limit values for chemical substances and physical agents and biological exposure indices. Cincinnati, OH: American Conference of Governmental Industrial Hygienists, 17.
- Adams RG, Harrison JF, Scott P. 1969. The development of cadmium-induced proteinuria, impaired renal function, and osteomalacia in alkaline battery workers. *Q J Med* 152:425-443.
- Adamsson E, Piscator M, Nogawa K. 1979. Pulmonary and gastrointestinal exposure to cadmium oxide dust in a battery factory. *Environ Health Perspect* 28:219-222.
- Ades AE, Kazantzis G. 1988. Lung cancer in a non-ferrous smelter: The role of cadmium. *Br J Ind Med* 45:435-442.
- Adinolfi M. 1985. The development of the human blood-CSF-brain barrier. *Dev Med Child Neurol* 27:532-537.
- Adlercreutz H. 1995. Phytoestrogens: Epidemiology and a possible role in cancer protection. *Environ Health Perspect Suppl* 103(7):103-112.
- Agarwal, S; Zaman, T; Tuzcu, EM; et al. 2011. Heavy metals and cardiovascular disease: Results from the National Health and Nutrition Examination Survey (NHANES) 1999-2006. *Angiology* 62(5):422-429.
- Agency for Toxic Substances and Disease Registry. 1989. Decision guide for identifying substance-specific data needs related to toxicological profiles. Atlanta, GA: Agency for Toxic Substances and Disease Registry, Division of Toxicology.
- Agency for Toxic Substances and Disease Registry. 1990a. Biomarkers of organ damage or dysfunction for the renal, hepatobiliary, and immune systems. Subcommittee on Biomarkers of Organ Damage and Dysfunction. Atlanta, GA: Agency for Toxic Substances and Disease Registry.
- Agency for Toxic Substances and Disease Registry. 1990b. Case studies in environmental medicine: Cadmium toxicity. Atlanta, GA: Agency for Toxic Substances and Disease Registry.

* Not cited in text

9. REFERENCES

- Akahori F, Masaoka T, Arai S. 1994. A nine-year chronic toxicity study of cadmium in monkeys. II. Effects of dietary cadmium on circulatory function plasma cholesterol and triglyceride. *Vet Hum Toxicol* 36(4):290-294.
- Åkesson A, Berglund M, Schutz A, et al. 2002. Cadmium exposure in pregnancy and lactation in relation to iron status. *Am J Public Health* 92(2):284-287.
- Åkesson A, Julin B, Wolk A. 2008. Long-term dietary cadmium intake and postmenopausal endometrial cancer incidence: A population-based prospective cohort study. *Cancer Res* 68(15):6435-6441.
- Åkesson A, Lundh T, Vahter M, et al. 2005. Tubular and glomerular kidney effects in Swedish women with low environmental cadmium exposure. *Environ Health Perspect* 113(11):1627-1631.
- Akinloye O, Arowojolu AO, Shittu OB, et al. 2006. Cadmium toxicity: A possible cause of male infertility in Nigeria. *Reprod Biol* 6(1):17-30.
- Alessio L, Apostoli P, Forni A, et al. 1993. Biological monitoring of cadmium exposure: An Italian experience. *Scand J Work Environ Health* 19:27-33.
- Alessio L, Berlin A, Dell'Orto A, et al. 1985. Reliability of urinary creatinine as a parameter used to adjust values of urinary biological indicators. *Int Arch Occup Environ Health* 55:99-106.
- Alfvén T, Elinder CG, Carlsson MD, et al. 2000. Low-level cadmium exposure and osteoporosis. *J Bone Miner Res* 15(8):1579-1586.
- Alfvén T, Elinder CG, Hellstrom L, et al. 2004. Cadmium exposure and distal forearm fractures. *J Bone Miner Res* 19(6):900-905.
- Alfvén T, Jarup L, Elinder C. 2002a. Cadmium and lead in blood in relation to low bone mineral density and tubular proteinuria. (Erratum in: *Environ Health Perspect* 110(9):A505). *Environ Health Perspect* 110(7):699-702.
- Ali MM, Murthy RC, Chandra SV. 1986. Developmental and long term neurobehavioral toxicity of low level *in utero* cadmium exposure in rats. *Neurobehav Toxicol Teratol* 8:463-468.
- Alloway BJ, Steinnes E. 1999. Anthropogenic additions of cadmium to soils. In: *Cadmium in soils and plants*. Kluwer Academic Publishers, 97-123.
- Alloway BJ, Jackson AP, Morgan H. 1990. The accumulation of cadmium by vegetables grown on soils contaminated from a variety of sources. *Sci Total Environ* 91:223-236.
- Altman PK, Dittmer DS. 1974. *Biological handbooks: Biology data book*. Vol. III. 2nd ed. Bethesda, MD: Federation of American Societies for Experimental Biology, 1987-2008, 2041.
- Amacher DE, Paillet SC. 1980. Induction of trifluorothymidine-resistant mutants by metal ions in L5178Y/TK^{+/+} cells. *Mutat Res* 78:279-288.
- Andersen ME, Krishnan K. 1994. Relating *in vitro* to *in vivo* exposures with physiologically based tissue dosimetry and tissue response models. In: Salem H, ed. *Animal test alternatives: Refinement, reduction, replacement*. New York, NY: Marcel Dekker, Inc., 9-25.

9. REFERENCES

- Andersen ME, Clewell HJ, Gargas ML, et al. 1987a. Physiologically based pharmacokinetics and the risk assessment process for methylene chloride. *Toxicol Appl Pharmacol* 87:185-205.
- *Andersen ME, MacNaughton MG, Clewell HJ, et al. 1987b. Adjusting exposure limits for long and short exposure periods using a physiological pharmacokinetic model. *Am Ind Hyg Assoc J* 48(4):335-343.
- *Andersen O, Nielsen JB, Jones MM. 1989. Effects of dithiocarbamates on intestinal absorption and organ distribution of cadmium chloride in mice. *Pharmacol Toxicol* 64:239-243.
- Andersen O, Nielsen JB, Svendsen P. 1988. Oral cadmium chloride intoxication in mice: Effects of dose on tissue damage, intestinal absorption and relative organ distribution. *Toxicology* 48:225-236.
- Ando M, Hiratsuka N, Nakagawa J, et al. 1998. Cadmium accumulation in rats treated orally with cadmium chloride for 8 months. *J Toxicol Sci* 23(3):243-248.
- *Ando M, Matsui S, Jinno H, et al. 1988. Generation of hypophosphatemia in rats by continuous oral administration of cadmium. *Toxicology* 53:1-10.
- Angelo RT, Cringan MS, Chamberlain DL, et al. 2007. Residual effects of lead and zinc mining on freshwater mussels in the Spring River Basin (Kansas, Missouri, and Oklahoma, USA). *Sci Total Environ* 384:467-496.
- Anonymous. 1994. Heavy metals in sewage sludge. *Food Chem Toxicol* 32(6):583-588.
- Antonio MT, Peinado V, Gonzalez JC, et al. 2010. Effects of maternal cadmium administration on development of monoaminergic, GABAergic and glutamatergic systems. *Environ Toxicol Pharmacol* 29(1):87-90.
- AOAC. 1984. In: Williams S, ed. *Official methods of analysis of the Association of Official Analytical Chemists*. 14th ed. Arlington, VA: Association of Official Analytical Chemists, Inc., 444-453.
- Aoshima K, Fan J, Cai Y, et al. 2003. Assessment of bone metabolism in cadmium-induced renal tubular dysfunction by measurements of biochemical markers. *Toxicol Lett* 136(3):183-192.
- APHA. 1977a. Tentative method of analysis for cadmium content of atmospheric particulate matter. Method 304. In: Katz M, ed. *Methods of air sampling and analysis*. 2nd ed. Washington, DC: American Public Health Association, 444-446.
- APHA. 1977b. Tentative method of analysis for cadmium content of atmospheric particulate matter by atomic absorption spectroscopy. Method 311. In: Katz M, ed. *Methods of air sampling and analysis*. 2nd ed. Washington, DC: American Public Health Association, 466-471.
- Apinan R, Satarug S, Ruengweerayut R, et al. 2010. The influence of iron stores on cadmium body burden in a Thai population. *Environ Geochem Health* 32(3):237-242.
- Arisawa K, Nakano A, Honda S, et al. 1997. Reproducibility of urinary β -microglobulin and cadmium excretion among residents in a cadmium-polluted area during a 3-year period. *Toxicol Lett* 91:147-152.
- Arisawa K, Nakano A, Saito H, et al. 2001. Mortality and cancer incidence among a population previously exposed to environmental cadmium. *Int Arch Occup Environ Health* 74:255-262.

9. REFERENCES

- *Arisawa K, Uemura H, Hiyoshi M, et al. 2007a. Cadmium-induced renal dysfunction and mortality in two cohorts: Disappearance of the association in a generation born later. *Toxicol Lett* 169(3):214-221.
- Arisawa K, Uemura H, Hiyoshi M, et al. 2007b. Cause-specific mortality and cancer incidence rates in relation to urinary β 2-microglobulin: 23-Year follow-up study in a cadmium-polluted area. *Toxicol Lett* 173(3):168-174.
- Armstrong BG, Kazantzis G. 1983. The mortality of cadmium workers. *Lancet* 1(8339):1425-1427.
- Arnason JG, Fletcher BA. 2003. A 40+ year record of Cd, Hg, Pb, and U deposition in sediments of Patroon Reservoir, Albany County, NY, USA. *Environ Pollut* 123:383-391.
- Arora M, Weuve J, Schwartz J, et al. 2008. Association of environmental cadmium exposure with pediatric dental caries. *Environ Health Perspect* 116(6):821-825.
- Arora M, Weuve J, Schwartz J, et al. 2009. Association of environmental cadmium exposure with periodontal disease in U.S. adults. *Environ Health Perspect* 117(5):739-744.
- *Arvidson B. 1980. Regional differences in severity of cadmium-induced lesions in the peripheral nervous system in mice. *Acta Neuropathol (Berl)* 49:213-223.
- ASTER. 1994. ASTER (Assessment Tools for the Evaluation of Risk) ecotoxicity profile. Duluth, MN: Environmental Research Laboratory, U.S. Environmental Protection Agency.
- ASTER. 1995. ASTER (Assessment Tools for the Evaluation of Risk) ecotoxicity profile. Duluth, MN: U.S. Environmental Protection Agency, Environmental Research Laboratory.
- Aurelio L-M, Pilar DL, Fulgencio GG, et al. 1993. Levels of cadmium, lead and zinc protoporphyrin absorption in different risk groups. *Ann Occup Hyg* 37(6):655-663.
- Autier V, White D. 2004. Examination of cadmium sorption characteristics for a boreal soil near Fairbanks, Alaska. *J Hazard Mater* 106B:149-155.
- Axelsson B, Piscator M. 1966. Renal damage after prolonged exposure to cadmium. An experimental study. *Arch Environ Health* 12:360-373.
- Baer KN, Benson WH. 1987. Influence of chemical and environmental stressors on acute cadmium toxicity. *J Toxicol Environ Health* 22:35-44.
- Baker TD, Hafner WG. 1961. Cadmium poisoning from a refrigerator shelf used as an improvised barbecue grill. *Public Health Rep* 76:543-544.
- Bako G, Smith ES, Hanson J, et al. 1982. The geographical distribution of high cadmium concentrations in the environment and prostate cancer in Alberta. *Can J Public Health* 73:92-94.
- *Balaraman R, Gulati OD, Bhatt JD, et al. 1989. Cadmium-induced hypertension in rats. *Pharmacology* 38:226-234.
- Bandara JM, Wijewardena HV, Liyanage J, et al. 2010. Chronic renal failure in Sri Lanka caused by elevated dietary cadmium: Trojan horse of the green revolution. *Toxicol Lett* 198(1):33-39.

9. REFERENCES

- Baranowska I. 1995. Lead and cadmium in human placentas and maternal and neonatal blood (in a heavily polluted area) measured by graphite furnace atomic absorption spectrometry. *Occup Environ Med* 52(4):229-32.
- Baranski B. 1984. Behavioral alterations in offspring of female rats repeatedly exposed to cadmium oxide by inhalation. *Toxicol Lett* 22:53-61.
- Baranski B. 1985. Effect of exposure of pregnant rats to cadmium on prenatal and postnatal development of the young. *J Hyg Epidemiol Microbiol Immunol* 29:253-262.
- Baranski B. 1987. Effect of cadmium on prenatal development and on tissue cadmium, copper and zinc concentrations in rats. *Environ Res* 42:54-62.
- Baranski B, Sitarek K. 1987. Effect of oral and inhalation exposure to cadmium on the oestrous cycle in rats. *Toxicol Lett* 36:267-273.
- Baranski B, Stetkiewicz I, Sitarek K, et al. 1983. Effects of oral, subchronic cadmium administration on fertility, prenatal and postnatal progeny development in rats. *Arch Toxicol* 54:297-302.
- Bargagli R. 1993. Cadmium in marine organisms from the Tyrrhenian Sea: No evidence of pollution or biomagnification. *Oebalia* 19:13-25.
- Barnes DG, Dourson M. 1988. Reference dose (RfD): Description and use in health risk assessments. *Regul Toxicol Pharmacol* 8:471-486.
- Barnhart S, Rosenstock L. 1984. Cadmium chemical pneumonitis. *Chest* 86:789-791.
- Barrett HM, Irwin DA, Semmons E. 1947. Studies on the toxicity of inhaled cadmium. I. The acute toxicity of cadmium oxide by inhalation. *J Ind Hyg Toxicol* 29:279-285.
- Basinger MA, Jones MM, Holscher MA, et al. 1988. Antagonists for acute oral cadmium chloride intoxication. *J Toxicol Environ Health* 23:77-89.
- Bassendowska-Karska E, Zawadzka-Kos M. 1987. Cadmium sulfate does not induce sister chromatid exchanges in human lymphocytes *in vitro*. *Toxicol Lett* 37:173-175.
- Bauchinger M, Schmid E, Einbrodt HJ, et al. 1976. Chromosome aberrations in lymphocytes after occupational exposure to lead and cadmium. *Mutat Res* 49:57-62.
- Beevers DG, Cruickshank JK, Yeoman WB, et al. 1980. Blood-lead and cadmium in human hypertension. *J Environ Pathol Toxicol* 4:251-260.
- Benoff S, Hauser R, Marmar JL, et al. 2009. Cadmium concentrations in blood and seminal plasma: Correlations with sperm number and motility in three male populations (infertility patients, artificial insemination donors, and unselected volunteers). *Mol Med* 15(7-8):248-262.
- Berger GS, ed. 1994. Epidemiology of endometriosis. In: *Endometriosis: Advanced management and surgical techniques*. New York, NY: Springer-Verlag, 3-7.

9. REFERENCES

- *Berlin M, Fredricsson B, Linge G. 1961. Bone marrow changes in cadmium poisoning in rabbits. *Arch Environ Health* 3:58-66.
- Bermond A, Bourgeois S. 1992. Influence of soluble organic matter on cadmium mobility in model compounds and in soils. *Analyst* 117(3):685-687.
- Bernard AM, Lauwerys R. 1981. Retinol binding protein in urine: A more practical index than urinary β_2 -microglobulin for the routine screening of renal tubular function. *Clin Chem* 27:1781-1782.
- Bernard AM, Lauwerys R. 1986. Effects of cadmium exposure in humans. In: Foulkes EC, ed. *Handbook of experimental pharmacology*. Vol. 80. Berlin: Springer Verlag, 135-177.
- Bernard AM, Lauwerys R. 1989. Cadmium, NAG activity, and β_2 -microglobulin in the urine of cadmium pigment workers. *Br J Ind Med* 46:679-680.
- Bernard A, Buchet JP, Roels H, et al. 1979. Renal excretion of proteins and enzymes in workers exposed to cadmium. *Eur J Clin Invest* 9:11-22.
- Bernard A, Goret A, Buchet JP, et al. 1980. Significance of cadmium levels in blood and urine during long-term exposure of rats to cadmium. *J Toxicol Environ Health* 6:175-184.
- Bernard A, Lauwerys R, Amor AO. 1992. Loss of glomerular polyanion correlated with albuminuria in experimental cadmium nephropathy. *Arch Toxicol* 66:272-278.
- Bernard A, Stolte H, DeBroe ME, et al. 1997. Urinary biomarkers to detect significant effects of environmental and occupational exposure to nephrotoxins. IV. Current information on interpreting the health implications of tests. *Renal Fail* 19(4):553-566.
- Bernard AM, de Russis R, Amor AO, et al. 1988a. Potentiation of cadmium nephrotoxicity by acetaminophen. *Arch Toxicol* 62:291-294.
- *Bernard AM, Lauwerys R, Gengoux P, et al. 1984. Anti-laminin antibodies in Sprague-Dawley and brown Norway rats chronically exposed to cadmium. *Toxicology* 31:307-313.
- *Bernard AM, Ouled A, Roels H, et al. 1988b. Lack of relationship between urinary glycosaminoglycans and indices of tubular or glomerular renal damage: Urinary GAG are an unreliable nephrotoxicity index. *Nephron* 48:82-83.
- *Bernard AM, Ouled Amor A, Lauwerys RR. 1988c. Decrease of erythrocytes and glomerular membrane negative charges in chronic cadmium poisoning. *Br J Ind Med* 45:112-115.
- Bernard AM, Roels H, Cardenas A, et al. 1990. Assessment of urinary protein 1 and transferrin as early markers of cadmium nephrotoxicity. *Br J Ind Med* 47:559-565.
- Beton DC, Andrews GS, Davies HJ, et al. 1966. Acute cadmium fume poisoning; five cases with one death from renal necrosis. *Br J Ind Med* 23:292-301.
- *Bevan C, Foulkes EC. 1989. Interaction of cadmium with brush border membrane vesicles from the rat small intestine. *Toxicology* 54:297-309.

9. REFERENCES

- Beyer WN. 1986. A reexamination of biomagnification of metals in terrestrial food chains [Letter]. *Environ Toxicol Chem* 5:863-864.
- Beyer WN, Stafford C. 1993. Survey and evaluation of contaminants in earth worms and in soils derived from dredged material at confined disposal facilities in the Great Lakes region. *Environ Monit Assess* 24:151-165.
- Beyer WN, Hensler G, Moore J. 1987. Relation of pH and other soil variables to concentrations of Pb, Cu, Zn, Cd, and Se in earthworms. *Pedobiologia* 30:167-172.
- Bhattacharyya MH, Sellers DA, Peterson DP. 1986. Postlactational changes in cadmium retention and mice orally exposed to cadmium during pregnancy and lactation. *Environ Res* 40:145-154.
- Bhattacharyya MH, Whelton BD, Peterson DP. 1981. Gastrointestinal absorption of cadmium in mice during gestation and lactation. I. Short-term exposure studies. *Toxicol Appl Pharmacol* 61:335-342.
- Bhattacharyya MH, Whelton DB, Peterson DP. 1982. Gastrointestinal absorption of cadmium in mice during gestation and lactation. II. Continuous exposure studies. *Toxicol Appl Pharmacol* 66:368-375.
- Bhattacharyya MH, Whelton BD, Peterson DP, et al. 1988a. Kidney changes in multiparous mice fed a nutrient-sufficient diet containing cadmium. *Toxicology* 50:205-215.
- Bhattacharyya MH, Whelton BD, Peterson DP, et al. 1988b. Skeletal changes in multiparous mice fed a nutrient-sufficient diet containing cadmium. *Toxicology* 50:193-204.
- Bhattacharyya MH, Whelton BD, Stern PH, et al. 1988c. Cadmium accelerates bone loss in ovariectomized mice and fetal rat limb bones in culture. *Proc Natl Acad Sci* 85:8761-8765.
- Bjornberg A. 1963. Reactions to light in yellow tattoos from cadmium sulfide. *Arch Dermatol* 88:267-271.
- Blaha K, Nerudova J, Jehlicova H, et al. 1995. *In vivo* and *in vitro* efficacy of a new carbodithioate for the mobilization of cadmium. *J Toxicol Environ Health* 44:87-100.
- Blainey JD, Adams RG, Brewer DB, et al. 1980. Cadmium-induced osteomalacia. *Br J Ind Med* 37:278-284.
- Blakley BR. 1985. The effect of cadmium chloride on the immune response in mice. *Can J Comp Med* 49:104-108.
- Blakley BR. 1986. The effect of cadmium on chemical- and viral-induced tumor production in mice. *J Appl Toxicol* 6:425-429.
- Blakley BR. 1988. Humoral immunity in aged mice exposed to cadmium. *Can J Vet Res* 52:291-292.
- *Boisset M, Girard F, Godin J, et al. 1978. Cadmium content of lung, liver and kidney in rats exposed to cadmium oxide fumes. *Int Arch Occup Environ Health* 41:41-53.
- Bomhard E, Maruhn D, Paar D, et al. 1984. Urinary enzyme measurements as sensitive indicators of chronic cadmium nephrotoxicity. *Contrib Nephrol* 42:142-147.

9. REFERENCES

- Bomhard E, Vogel O, Loser E. 1987. Chronic effects on single and multiple oral and subcutaneous cadmium administration on the testes of Wistar rats. *Cancer Lett* 36:307-315.
- Bonnell JA. 1955. Emphysema and proteinuria in men casting copper-cadmium alloys. *Br J Ind Med* 12:181-197.
- Bonnevie NL, Huntley SL, Found BW, et al. 1994. Trace metal contamination in surficial sediments for Newark Bay, New Jersey. *Sci Total Environ* 144:1-16.
- *Borgman RF, Au B, Chandra RK. 1986. Immunopathology of chronic cadmium administration in mice. *Int J Immunopharmacol* 8:813-817.
- Börjesson J, Bellander T, Järup L, et al. 1997. *In vivo* analysis of cadmium in battery workers versus measurements of blood, urine, and workplace air. *Occup Environ Med* 54(6):424-431.
- Börjesson J, Gerhardsson L, Schutz A, et al. 2001. Kidney cadmium as compared to other markers of cadmium exposure in workers at a secondary metal smelter. *Am J Ind Med* 39(1):19-28.
- Borzelleca JF, Clarke EC, Condcie LW. 1989. Short-term toxicity (1 and 10 days) of cadmium chloride in male and female rats: Gavage and drinking water. *J Am Coll Toxicol* 8:377-404.
- Boscolo P, Carmignani M. 1986. Mechanisms of cardiovascular regulation in male rabbits chronically exposed to cadmium. *Br J Ind Med* 43:605-610.
- Boudreau J, Vincent R, Nadeau D, et al. 1989. The response of the pulmonary surfactant-associated alkaline phosphatase following acute cadmium chloride inhalation. *Am Ind Hyg Assoc J* 50:331-335.
- Boularbah A, Morel JL, Bitton, et al. 1992. Cadmium biosorption and toxicity to six cadmium-resistant gram-positive bacteria isolated from contaminated soil. *Environ Toxicol Water Qual* 7:237-246.
- Bouley G, Arsac F, Dubreuil A, et al. 1984. Natural and acquired resistance of mice to infection by airborne *Klebsiella pneumoniae* after subchronic intoxication by cadmium administered orally. *Sci Total Environ* 38:55-62.
- Bouley G, Chaumard C, Quero AM, et al. 1982. Opposite effects of inhaled cadmium microparticles on mouse susceptibility to an airborne bacterial and an airborne viral infection. *Sci Total Environ* 23:185-188.
- Bråtveit, M; Mageroy, N; Gundersen, H; et al. 2011. Biomarker of chronic cadmium exposure in a population residing in the vicinity of a zinc producing plant. *Sci Total Environ* 409:4222-4228.
- Brockhaus A, Collet W, Dolgner R, et al. 1988. Exposure to lead and cadmium of children living in different areas of North-West Germany: Results of biological monitoring studies 1982-1986. *Int Arch Occup Environ Health* 60:211-222.
- Bronstein AC, Currance PL. 1988. Emergency care for hazardous materials exposure. St. Louis, MO: The C.V. Mosby Company, 133-134.
- Bruce WR, Heddle JA. 1979. The mutagenic activity of 61 agents as determined by the micronucleus, *salmonella*, and sperm abnormality assays. *Can J Genet Cytol* 21:319-334.

9. REFERENCES

- Bruhn JC, Franke AA. 1976. Lead and cadmium in California raw milk. *J Dairy Sci* 59:1711-1717.
- Brumbaugh WG, Schmitt CJ, May TW. 2005. Concentrations of cadmium, lead, and zinc in fish from mining-influenced waters of Northeastern Oklahoma: Sampling of blood, carcass, and liver for aquatic biomonitoring. *Arch Environ Contam Toxicol* 49:76-88.
- Brzóška MM. 2012. Low-level chronic exposure to cadmium enhances the risk of long bone fractures: A study on a female rat model of human lifetime exposure. *J Appl Toxicol* 32(1):34-44.
- Brzóška MM, Moniuszko-Jakoniuk J. 2004a. Low-level exposure to cadmium during the lifetime increases the risk of osteoporosis and fractures of the lumbar spine in the elderly: Studies on a rat model of human environmental exposure. *Toxicol Sci* 82:468-477.
- Brzóška MM, Moniuszko-Jakoniuk J. 2004b. Low-level lifetime exposure to cadmium decreases skeletal mineralization and enhances bone loss in aged rats. *Bone* 35(5):1180-1191.
- Brzóška MM, Moniuszko-Jakoniuk J. 2005a. Bone metabolism of male rats chronically exposed to cadmium. *Toxicol Appl Pharmacol* 207(3):195-211.
- Brzóška MM, Moniuszko-Jakoniuk J. 2005b. Effect of chronic exposure to cadmium on the mineral status and mechanical properties of lumbar spine of male rats. *Toxicol Lett* 157(2):161-172.
- Brzóška MM, Moniuszko-Jakoniuk J. 2005c. Effect of low-level lifetime exposure to cadmium on calcitropic hormones in aged female rats. *Arch Toxicol* 79(11):636-646.
- Brzóška MM, Moniuszko-Jakoniuk J. 2005d. Disorders in bone metabolism of female rats chronically exposed to cadmium. *Toxicol Appl Pharmacol* 202(1):68-83.
- *Brzóška MM, Kaminski M, Dziki M, et al. 2004a. Changes in the structure and function of the kidney of rats chronically exposed to cadmium. II. Histoenzymatic studies. *Arch Toxicol* 78(4):226-231.
- Brzóška MM, Majewska K, Kupraszewicz E. 2010. Effects of low, moderate and relatively high chronic exposure to cadmium on long bones susceptibility to fractures in male rats. *Environ Toxicol Pharmacol* 29(3):235-245.
- Brzóška MM, Majewska K, Moniuszko-Jakoniuk J. 2004b. Mineral status and mechanical properties of lumbar spine of female rats chronically exposed to various levels of cadmium. *Bone* 34(3):517-526.
- Brzóška MM, Majewska K, Moniuszko-Jakoniuk J. 2005a. Bone mineral density, chemical composition and biomechanical properties of the tibia of female rats exposed to cadmium since weaning up to skeletal maturity. *Food Chem Toxicol* 43(10):1507-1519.
- Brzóška MM, Majewska K, Moniuszko-Jakoniuk J. 2005b. Mechanical properties of femoral diaphysis and femoral neck of female rats chronically exposed to various levels of cadmium. *Calcif Tissue Int* 76(4):287-298.
- Brzóška MM, Majewska K, Moniuszko-Jakoniuk J. 2005c. Weakness in the mechanical properties of the femur of growing female rats exposed to cadmium. *Arch Toxicol* 79(5):277-288.
- Buchet JP, Lauwerys R, Roels H, et al. 1990. Renal effects of cadmium body burden of the general population. *Lancet* 336:699-702.

9. REFERENCES

- Buckler HM, Smith WD, Rees WD. 1986. Self poisoning with oral cadmium chloride. *Br Med J* 292:1559-1560.
- *Buckley BJ, Bassett DJ. 1987a. Glutathione redox status of control and cadmium oxide-exposed rat lungs during oxidant stress. *J Toxicol Environ Health* 22:287-299.
- Buckley BJ, Bassett DJ. 1987b. Pulmonary cadmium oxide toxicity in the rat. *J Toxicol Environ Health* 22:233-250.
- Buck Louis GM, Sundaram R, Schisterman EF, et al. 2012. Heavy metals and couple fecundity, the LIFE Study. *Chemosphere* [Epub ahead of print].
- Bui TH, Lindsten J, Nordberg GJ. 1975. Chromosome analysis of lymphocytes from cadmium workers and Itai-itai patients. *Environ Res* 9:187-195.
- *Bunker VW, Lawson MS, Delues HT, et al. 1984. The intake and excretion of lead and cadmium by the elderly. *Am J Clin Nutr* 39:803-808.
- Burke BE, Pfister RM. 1988. The removal of cadmium from lake water by lake sediment bacteria. In: *Proceedings of the Annual Meeting of the American Society for Microbiology, Miami Beach, Florida, USA, May 8-13, 1988.*
- Bus JS, Vinegar A, Brooks SM. 1978. Biochemical and physiologic changes in lungs of rats exposed to a cadmium chloride aerosol. *Am Rev Respir Dis* 118:573-580.
- Bustueva KA, Revich BA, Bezpalko LE. 1994. Cadmium in the environment of three Russian cities and in human hair and urine. *Arch Environ Health* 49(4):284-288.
- Cabrera C, Lorenzo ML, Lopez MC. 1995. Lead and cadmium contamination in dairy products and its repercussion on total dietary intake. *J Agric Food Chem* 43:1605-1609.
- *Cafilisch CR. 1994. Effect of orally administered cadmium on in situ pH, PCO₂, and bicarbonate concentration in rat testis and epididymis. *J Toxicol Environ Health* 42(3):323-30.
- Cai MY, Arenaz P. 1998. Antimutagenic effect of crown ethers on heavy metal-induced sister chromatid exchanges. *Mutagenesis* 13:27-32.
- Cai S, Wang J, Xue J, et al. 1992. A judgment of attribution of increase in urine β_2 -microglobulin after environmental cadmium exposure. *Biomed Environ Sci* 5(2):130-135.
- Cai S, Yui L, Hu Z, et al. 1990. Cadmium exposure and health effects among residents in an irrigation area with ore dressing wastewater. *Sci Total Environ* 90:67-73.
- Cai S, Yue L, Jin T, et al. 1998. Renal dysfunction from cadmium contamination of irrigation water: Dose-response analysis in a Chinese population. *Bull World Health Org* 76(22):153-159.
- Cai Y, Aoshima K, Katoh T, et al. 2001. Renal tubular dysfunction in male inhabitants of a cadmium-polluted area in Toyama, Japan-an eleven year follow-up study. *J Epidemiol* 11(4):180-189.

9. REFERENCES

- Campbell KR. 1994. Concentrations of heavy metals associated with urban runoff in fish living in stormwater treatment ponds. *Arch Environ Contam Toxicol* 27:352-356.
- Canfield TJ, Kemble NE, Brumbaugh WG, et al. 1994. Use of benthic invertebrate community structure and the sediment quality triad to evaluate metal-contaminated sediment in the upper Clark Fork River, Montana. *Environ Toxicol Chem* 13(12):1999-2012.
- Cantilena LR, Klaassen CD. 1980. The effect of ethylenediaminetetraacetic acid (EDTA) and EDTA plus salicylate on acute cadmium toxicity and distribution. *Toxicol Appl Pharmacol* 53(3):510-514.
- Cantilena LR, Klaassen CD. 1981. Comparison of the effectiveness of several chelators after single administration on the toxicity, excretion, and distribution of cadmium. *Toxicol Appl Pharmacol* 58:452-460.
- Cantilena LR, Klaassen CD. 1982a. Decreased effectiveness of chelation therapy with time after acute cadmium poisoning. *Toxicol Appl Pharmacol* 63:173-180.
- Cantilena LR, Klaassen CD. 1982b. The effect of repeated administration of several chelators on the distribution and excretion of cadmium. *Toxicol Appl Pharmacol* 66:361-367.
- Cao, Y; Chen, A; Radcliffe, J; et al. 2009. Postnatal cadmium exposure, neurodevelopment, and blood pressure in children at 2, 5, and 7 years of age. *Environ Health Perspect* 117(10):1580-1586.
- Capar SG, Cunningham WC. 2000. Element and radionuclide concentrations in food: FDA total diet study 1991-1996. *J AOAC Int* 83(1):157-177.
- Capar SG, Yess NJ. 1996. U.S. Food and Drug Administration survey of cadmium, lead and other elements in clams and oysters. *Food Addit Contam* 13(5):553-560.
- Caravati EM, McGuigan MA, MacGregor Whyte I, et al. Cadmium fume pneumonitis. In: *Medical toxicology*, 3rd ed. Philadelphia, PA: Lippincott Williams & Wilkins, 1411-1414/
- Cardenas A, Bernard A, Lauwerys R. 1992a. Incorporation of [³⁵S]sulfate into glomerular membranes of rats chronically exposed to cadmium and its relation with urinary glycosaminoglycans and proteinuria. *Toxicology* 76:219-231.
- Cardenas A, Remis I, Hotter G, et al. 1992b. Human and experimental studies on renal eicosanoid response to long term cadmium exposure. *Toxicol Appl Pharmacol* 116:155-160.
- Caride A, Fernandez-Perez B, Cabaleiro T, et al. 2010b. Cadmium chronotoxicity at pituitary level: effects on plasma ACTH, GH, and TSH daily pattern. *J Physiol Biochem* 66(3):213-22
- Caride A, Fernandez Perez B, Cabaleiro T, et al. 2010a. Daily pattern of pituitary glutamine, glutamate, and aspartate content disrupted by cadmium exposure. *Amino Acids* 38(4):1165-1172.
- Carmignani N, Boscolo P. 1984. Cardiovascular responsiveness to physiological agonists of female rats made hypertensive by long-term exposure to cadmium. *Sci Total Environ* 34:19-33.
- *Carroll RE. 1966. The relationship of cadmium in the air to cardiovascular disease death rates. *JAMA* 198:267-269.

9. REFERENCES

- Carvalho FM, Silvany-Neto AM, Melo AM, et al. 1989. Cadmium in hair of children living near a lead smelter in Brazil. *Sci Total Environ* 84:119-128.
- Carvalho FM, Silvany-Neto AM, Lima MEC Atl, et al. 1986. Cadmium concentrations in blood of children living near a lead smelter in Bahia, Brazil. *Environ Res* 40:437-449.
- Casto BC, Meyers J, DiPaolo JA, et al. 1979. Enhancement of viral transformation for evaluation of the carcinogenic or mutagenic potential of inorganic metal salts. *Cancer Res* 39:193-198.
- CDC. 2005. Third national report on human exposure to environmental chemicals. Atlanta, GA: U.S. Department of Health and Human Services, Centers for Disease Control and Prevention.
- CDC. 2011. Fourth national report on human exposure to environmental chemicals, updated tables, February 2011. http://www.cdc.gov/exposurereport/pdf/Updated_Tables.pdf. January 11, 2012.
- CDC. 2012. Fourth national report on human exposure to environmental chemicals, updated tables, February 2012. Atlanta, GA: Centers for Disease Control and Prevention. http://www.cdc.gov/exposurereport/pdf/FourthReport_UpdatedTables_Feb2012.pdf. September 10, 2012.
- Cerny EA, Bhattacharyya MH. 2003. Low-volume, high-sensitivity assay for cadmium in blood and urine using conventional atomic absorption spectrophotometry. *Anal Biochem* 314(2):190-193.
- Cha CW. 1987. A study on the effect of garlic to the heavy metal poisoning of rat. *J Korean Med Sci* 2:213-224.
- Chan HM, Cherian MG. 1993. Mobilization of hepatic cadmium in pregnant rats. *Toxicol Appl Pharmacol* 120:308-314.
- Chan OY, Poh SC, Lee HS, et al. 1988. Respiratory function in cadmium battery workers: A follow-up study. *Ann Acad Med Singapore* 17:283-287.
- Chang PP, Robinson JW. 1993. Development of thermospray interfaced HPLC-FAAS system for studies on cadmium speciation in human body fluid. *Spectrosc Lett* 26(10):2017-2035.
- *Chatterjee MS, Abdel-Rahman M, Bhandal A, et al. 1988. Amniotic fluid cadmium and thiocyanate in pregnant women who smoke. *J Reprod Med* 33:417-420.
- *Chen WK, Chung C. 1989. *In vivo* and *in vitro* medical diagnoses of toxic cadmium in rats. *J Radioanal Nucl Chem* 133(2):349-358.
- Chen L, Jin T, Huang B, et al. 2006a. Plasma metallothionein antibody and cadmium-induced renal dysfunction in an occupation population in China. *Toxicol Sci* 91(1):104-112.
- Chen L, Jin T, Huang B, et al. 2006b. Critical exposure level of cadmium for elevated urinary metallothionein: An occupational population study in China. *Toxicol Appl Pharmacol* 215(1):93-99.
- Chen L, Lei L, Jin T, et al. 2006c. Plasma metallothionein antibody, urinary cadmium, and renal dysfunction in a Chinese type 2 diabetic population. *Diabetes Care* 29:2682-2687.

9. REFERENCES

- Chen RW, Whanger PD, Weswig PH. 1975. Selenium induced redistribution of cadmium-binding to tissue proteins: A possible mechanism of protection against cadmium toxicity. *Bioinorg Chem* 4:125.
- Chen X, Zhu G, Jin T, et al. 2009. Effects of cadmium on forearm bone density after reduction of exposure for 10 years in a Chinese population. *Environ Int* 35(8):1164-1168.
- Chen X, Zhu G, Jin T, et al. 2011. Bone mineral density is related with previous renal dysfunction caused by cadmium exposure. *Environ Toxicol Pharmacol* 32(1):46-53.
- Cherian MG, Shaikh ZA. 1975. Metabolism of intravenously injected cadmium-binding protein. *Biochem Biophys Res Commun* 65:863-869.
- Chettle DR, Ellis KJ. 1992. Further scientific issues in determining an occupational standard for cadmium. *Am J Ind Med* 22:117-124.
- Chia KS, Ong CN, Ong HY, et al. 1989. Renal tubular function of workers exposed to low levels of cadmium. *Br J Ind Med* 46:165-170.
- Chia KS, Tan AL, Chia SE, et al. 1992. Renal tubular function of cadmium exposed workers. *Ann Acad Med Singapore* 21(6):756-759.
- *Chiarenza A, Elverdin JC, Espinal E, et al. 1989. Effects of cadmium on the function and structure of the rat salivary glands. *Arch Oral Biol* 34:999-1002.
- *Chmielnicka J, Halatek T, Jedlinska U. 1989. Correlation of cadmium-induced nephropathy and the metabolism of endogenous copper and zinc in rats. *Ecotoxicol Environ Saf* 18:268-276.
- Chopra RK, Prasad R, Sharma N, et al. 1984. Effect of dietary chronic cadmium exposure on cell-mediated immune response in Rhesus monkeys (*Macaca mulatta*): Role of calcium deficiency. *Arch Toxicol* 56:128-131.
- Choudhury H, Harvey T, Thayer WC, et al. 2001. Urinary cadmium elimination as a biomarker of exposure for evaluating a cadmium dietary exposure-biokinetics model. *J Toxicol Environ Health A* 63:321-350.
- Christoffersson JO, Welinder H, Spang G, et al. 1987. Cadmium concentration in the kidney cortex of occupationally exposed workers measured *in vivo* using X-ray fluorescence analysis. *Environ Res* 42:489-499.
- Chung J, Nartey NO, Cherian MG. 1986. Metallothionein levels in liver and kidney of Canadians: A potential indicator of environmental exposure to cadmium. *Arch Environ Health* 41:319-323.
- Cifone MG, Alesse E, Di Egenio R, et al. 1989a. *In vivo* cadmium treatment alters natural killer activity and large granular lymphocyte number in the rat. *Immunopharmacology* 18:149-156.
- *Cifone MG, Alesse E, Procopio A, et al. 1989b. Effects of cadmium on lymphocyte activation. *Biochim Biophys Acta* 1011:25-32.
- *Clark DE, Nation JR, Bourgeois AJ, et al. 1985. The regional distribution of cadmium in the brains of orally exposed adult rats. *Neurotoxicology* 6:109-114.

9. REFERENCES

- Clewell HJ, Andersen M. 1985. Risk assessment extrapolations and physiological modeling. *Toxicol Ind Health* 1(4):111-131.
- Cole RH, Frederick RE, Healy RP, et al. 1984. Preliminary findings of the Priority Pollutant Monitoring Project of the Nationwide Urban Runoff Program. *J Water Pollut Contr Fed* 56:898-908.
- Cordero MTS, de Torres AG, Pavon JMC. 1994. Solvent extraction of cadmium as a previous step for its determination in biological samples by inductively coupled plasma atomic emission spectrometry. *Anal Lett* 27(9):1689-1701.
- Cortona G, Apostoli P, Toffoletto F, et al. 1992. Occupational exposure to cadmium and lung function. In: Nordberg GF, Herber RFM, Alessio L, eds. *Cadmium in the human environment: Toxicity and carcinogenicity*. IARC Scientific Publications No. 118. Lyon, France: International Agency for Research on Cancer, 205-210.
- Cousins RJ, Barber AK, Trout JR. 1973. Cadmium toxicity in growing swine. *J Nutr* 103:964-972.
- Cresta L, Perdelli F, Franco Y, et al. 1989. [Possible correlations between urinary cadmium and fetal growth retardation in pregnant women who smoke.] *Minerva Genecol* 41:85-88. (Italian)
- Crews HM, Dean JR, Ebdon L, et al. 1989. Application of high-performance liquid chromatography-inductively coupled plasma mass spectrometry to the investigation of cadmium speciation in pig kidney following cooking and *in vitro* gastrointestinal digestion. *Analyst* 114:895-899.
- Crews HM, Owen LM, Langford N, et al. 2000. Use of the stable isotope ^{106}Cd for studying dietary cadmium absorption in humans. *Toxicol Lett* 112-113:201-207.
- Cummins PE, Dutton J, Evans CJ, et al. 1980. An *in vivo* study of renal cadmium and hypertension. *Eur J Clin Invest* 10:459-461.
- Dabeka RW. 1979. Graphite furnace atomic absorption spectrometric determination of lead and cadmium in foods after solvent extraction and stripping. *Anal Chem* 51:902-907.
- Daih B, Huang H. 1992. Determination of trace elements in sea water by flow-injection anodic stripping voltammetry preceded by immobilized quinolin-8-ol silica gel preconcentration. *Anal Chim Acta* 258:245-252.
- Daniels MJ, Menache MG, Burleson GR, et al. 1987. Effects of NiCl_2 and CdCl_2 on susceptibility to murine cytomegalovirus and virus-augmented natural killer cell and interferon responses. *Fundam Appl Toxicol* 8:443-453.
- Davison AG, Fayers PM, Taylor AJ, et al. 1988. Cadmium fume inhalation and emphysema. *Lancet* 1(8587):663-667.
- Deaven LL, Campbell EW. 1980. Factors affecting the induction of chromosomal aberrations by cadmium in Chinese hamster cells. *Cytogenet Cell Genet* 26:251-260.
- de Burbure C, Buchet JP, Leroyer A, et al. 2006. Renal and neurologic effects of cadmium, lead, mercury, and arsenic in children: Evidence of early effects and multiple interactions at environmental exposure levels. *Environ Health Perspect* 114(8):A458.

9. REFERENCES

- Debusk TA, Laughlin R B JR, Schwartz LN. 1996. Retention and compartmentalization of lead and cadmium in wetland microcosms. *Water Res* 30 (11):2707-2716.
- Decker LE, Byerrum RU, Decker CF, et al. 1958. Chronic toxicity studies. I. Cadmium administered in drinking water to rats. *AMA Arch Ind Health* 18:228-231.
- Deknudt G, Gerber GB. 1979. Chromosomal aberrations in bone marrow cells of mice given a normal or a calcium-deficient diet supplemented with various heavy metals. *Mutat Res* 68:163-168.
- Deknudt G, Deminatti M. 1978. Chromosome studies in human lymphocytes after *in vitro* exposure to metal salts. *Toxicology* 10:67-75.
- Deknudt G, Leonard A. 1975. Cytogenetic investigations on leucocytes of workers from a cadmium plant. *Environ Physiol Biochem* 5:319-327.
- Deknudt G, Leonard A, Ivanov B. 1973. Chromosome aberrations in male workers occupationally exposed to lead. *Environ Physiol Biochem* 3:132-138.
- de Kort WL, Verschoor MA, Wibowo AA, et al. 1987. Occupational exposure to lead and blood pressure: A study in 105 workers. *Am J Ind Med* 11:145-156.
- Denizeau F, Marion M. 1989. Genotoxic effects of heavy metals in rat hepatocytes. *Cell Biol Toxicol* 5:15-26.
- Depault F, Cojocar M, Fortin F, et al. 2006. Genotoxic effects of chromium(VI) and cadmium(II) in human blood lymphocytes using the electron microscopy *in situ* end-labeling (EM-ISEL) assay. *Toxicol In Vitro* 20(4):513-518.
- Dervan PA, Hayes JA. 1979. Peribronchiolar fibrosis following acute experimental lung damage by cadmium aerosol. *J Pathol* 128:143-149.
- Desi I, Nagymajtenyi L, Schulz H. 1998. Behavioral and neurotoxicological changes caused by cadmium treatment of rats during development. *J Appl Toxicol* 18(1):63-70.
- Desi I, Nehez M, Siroki O, et al. 2000. Small subchronic doses of the pesticide dimethoate and/or cadmium and lead treatment causes disturbances in the chromosomes of young rats. *Cent Eur J Public Health* 8:59-60.
- Devi KD, Banu BS, Mahboob M, et al. 2001. *In vivo* genotoxic effect of cadmium chloride in mice leukocytes using comet assay. *Teratog Carcinog Mutagen* 21(5):325-333.
- DHHS. September 1995. Report to Congress on workers' home contamination study conducted under the workers' family protection act (29 U.S.C. 671a). Cincinnati, OH: U.S. Department of Health and Human Services, Public Health Service, Centers for Disease Control and Prevention, National Institute for Occupational Safety and Health.
- Diamond GL, Thayer WC, Choudhury H. 2003. Pharmacokinetics/pharmacodynamics (PK/PD) modeling of risks of kidney toxicity from exposure to cadmium: Estimates of dietary risks in the U.S. population. *J Toxicol Environ Health A* 66:2141-2164.

9. REFERENCES

- *Diaz-Barriga F, Santos MA, Mejia JDJ, et al. 1993. Arsenic and cadmium exposure in children living near a smelter complex in San Luis Potosi, Mexico. *Environ Res* 62(2):242-250.
- Ding X, Jiang J, Wang Y, et al. 1994. Bioconcentration of cadmium in water hyacinth (*Eichhornia crassipes*) in relation to thiol group content. *Environ Pollut* 84(1):93-96.
- DiPaulo JA, Castro BC. 1979. Quantitative studies of *in vitro* morphological transformation of Syrian hamster cells by inorganic metal salts. *Cancer Res* 39:1008-1013.
- Dixon RL, Lee IP, Sherins RJ. 1976. Methods to assess reproductive effects of environmental chemicals: Studies of cadmium and boron administered orally. *Environ Health Perspect* 13:59-67.
- DOI. 1985. Cadmium hazards to fish, wildlife, and invertebrates: A synoptic view. U.S. Fish and Wildlife Service Biological Report 85(1.2). Washington, DC: U.S. Department of the Interior.
- Doll R. 1992. Is cadmium a human carcinogen? *Ann Epidemiol* 2:335-337.
- Dorian C, Gattone VH, Klaasen CD. 1992a. Renal cadmium deposition and injury as a result of accumulation of cadmium-metallothionein (CdMT) by the proximal convoluted tubules: A light microscopic autoradiography study with ¹⁰⁹CdMT. *Toxicol Appl Pharmacol* 114:173-181.
- Dorian C, Gattone VH, Klaasen CD. 1992b. Accumulation and degradation of the protein moiety of cadmium-metallothionein (CdMT) in the mouse kidney. *Toxicol Appl Pharmacol* 117:242-248.
- Dorian C, Gattone VH, Klaasen CD. 1995. Discrepancy between the nephrotoxic potencies of cadmium - metallothionein and cadmium chloride and the renal concentration of cadmium in the proximal convoluted tubules. *Toxicol Appl Pharmacol* 130:161-168.
- Dorian C, Klaassen CD. 1995. Protection by zinc-metallothionein (znmt) against cadmium-metallothionein-induced nephrotoxicity. *Fundam Appl Toxicol* 26(1):99-106.
- Doyle JJ, Pfander WH, Grebing SE, et al. 1974. Effect of dietary cadmium on growth, cadmium absorption and cadmium tissue levels in growing lambs. *J Nutr* 104(2):160-166.
- *Drasch GA, Kretschmer E, Neidlinger P, et al. 1989. Cadmium, zinc, copper and metallothionein in human tissues (liver and kidney). *Toxicol Environ Chem* 23:207-214.
- Driscoll KE, Maurer JK, Poynter J, et al. 1992. Stimulation of rat alveolar macrophage fibronectin release in a cadmium chloride model of lung injury and fibrosis. *Toxicol Appl Pharmacol* 116:30-37.
- Dudley RE, Gammal LM, Klaassen CD. 1985. Cadmium-induced hepatic and renal injury in chronically exposed rats: Likely role of hepatic cadmium-metallothionein in nephrotoxicity. *Toxicol Appl Pharmacol* 77:414-426.
- Edling C, Elinder CG, Randma E. 1986. Lung function in workers using cadmium-containing solders. *Br J Ind Med* 43:657-662.
- *Eggert-Kruse W, Rohr G, Jochum R, et al. 1992. [The effect of heavy metals on the *in vitro* interaction between human sperm and cervical mucus]. *Dtsch Med Wochenschr* 117(37):1383-1389. (German)

9. REFERENCES

- Egwuogu H, Shendell DG, Okosun IS, et al. 2009. The effect of urinary cadmium on cardiovascular fitness as measured by VO₂ max in white, black and Mexican Americans. *Environ Res* 109(3):292-300.
- Eklund G, Grawe KP, Oskarsson A. 2001. Bioavailability of cadmium from infant diets in newborn rats. *Arch Toxicol* 75:522-530.
- Eklund G, Tallkvist J, Oskarsson A. 2004. A piglet model for studies of gastrointestinal uptake of cadmium in neonates. *Toxicol Lett* 146(3):237-247.
- Elinder CG. 1985a. Cadmium: Uses, occurrence and intake. In: Friberg L, Elinder CG, Kjellström T, et al., eds. *Cadmium and health: A toxicological and epidemiological appraisal*. Vol. I. Exposure, dose, and metabolism. Effects and response. Boca Raton, FL: CRC Press, 23-64.
- Elinder CG. 1985b. Normal values for cadmium in human tissue, blood and urine in different countries. In: Friberg L, Elinder CG, Kjellström T, et al., eds. *Cadmium and health: A toxicological and epidemiological appraisal*. Vol. I. Exposure, dose, and metabolism. Effects and response. Boca Raton, FL: CRC Press, 81-102.
- Elinder CG. 1986b. Respiratory effects. In: Friberg L, Elinder CG, Kjellström T, et al., eds. *Cadmium and health: A toxicological and epidemiological appraisal*. Vol. II. Effects and response. Boca Raton, FL: CRC Press, 1-20.
- Elinder CG. 1992. Cadmium as an environmental hazard. *IARC Sci Publ* 118:123-132.
- Elinder CG, Lind B. 1985. Principles and problems of cadmium analysis. In: Friberg L, Elinder CG, Kjellström T, et al., eds. *Cadmium and health: A toxicological and epidemiological appraisal*. Vol. I. Boca Raton, FL: CRC Press, 7-22.
- Elinder CG, Edling C, Lindberg E, et al. 1985a. Assessment of renal function in workers previously exposed to cadmium. *Br J Ind Med* 42:754-760.
- Elinder CG, Edling C, Lindberg E, et al. 1985b. β_2 -Microglobulinuria among workers previously exposed to cadmium: Follow-up and dose-response analyses. *Am J Ind Med* 8:553-564.
- Elinder CG, Kjellström T, Hogstedt C, et al. 1985c. Cancer mortality of cadmium workers. *Br J Ind Med* 42:651-655.
- Elinder CG, Kjellström T, Lind B, et al. 1978. Cadmium concentrations in human liver, blood, and bile: Comparison with a metabolic model. *Environ Res* 17(2):236-241.
- Ellenhorn MJ, Barceloux DJ. 1988. *Medical toxicology: Diagnosis and treatment of human poisoning*. New York, NY: Elsevier, 1018-1020.
- Ellis KJ. 1985. Dose-response analysis of heavy metal toxicants in man: Direct *in vivo* assessment of body burden. *Trace Subst Environ Health* 19:149-159.
- Ellis KJ, Cohn SH, Smith TJ. 1985. Cadmium inhalation exposure estimates: Their significance with respect to kidney and liver cadmium burden. *J Tox Environ Health* 15:173-187.
- Ellis KJ, Vartsky D, Zanzi I, et al. 1979. Cadmium: *In vivo* measurement in smokers and nonsmokers. *Science* 205:323-325.

9. REFERENCES

Ellis KJ, Yuen K, Yasumura S, et al. 1984. Dose-response analysis of cadmium in man: Body burden vs kidney dysfunction. *Environ Res* 33:216-226.

Engström A, Skerving S, Lidfeldt J, et al. 2009. Cadmium-induced bone effect is not mediated via low serum 1,25-dihydroxy vitamin D. *Environ Res* 109(2):188-192.

Engström B, Nordberg GF. 1979. Dose-dependence of gastrointestinal absorption and biological half-time of cadmium in mice. *Toxicology* 13:215-222.

*Engström B, Norin H, Jawaid M, et al. 1980. Influence of different Cd-EDTA complexes on distribution and toxicity of cadmium in mice after oral or parenteral administration. *Acta Pharmacol Toxicol (Copenh)* 46:219-234.

EPA. 1979. Water-related fate of 129 priority pollutants. Washington, DC: U.S. Environmental Protection Agency, Office of Water Planning and Standards. EPA 440479029a.

*EPA. 1980a. Ambient air quality criteria for cadmium. Washington, DC.: U.S. Environmental Protection Agency, Office of Water Regulations and Standards. EPA440580025.

*EPA. 1980b. Land treatment waste analysis. U.S. Environmental Protection Agency. Code of Federal Regulations. 40 CFR 265.273.

*EPA. 1980c. Land treatment: Food chain crops. U.S. Environmental Protection Agency. Code of Federal Regulations. 40 CFR 265.276.

EPA. 1980d. Atmospheric cycles of cadmium and lead: Emissions, transport, transformation and removal. U.S. Environmental Protection Agency, 1-6 to 1-17; 2-14 to 2-41.

EPA. 1981a. Health assessment document for cadmium. Research Triangle Park, NC: U.S. Environmental Protection Agency. EPA600881023. PB82115163.

*EPA. 1981b. Electroplating pretreatment standards. U.S. Environmental Protection Agency. Code of Federal Regulations. 40 CFR 413.14.

EPA. 1982a. Intermedia priority pollutant guidance documents. Cadmium. Washington, DC: U.S. Environmental Protection Agency, Office of Toxics Integration.

*EPA. 1982b. Methods for chemical analysis of water and wastes. Method 200.7. Inductively coupled plasma - atomic emission spectrometric method for trace element analysis of water and wastes. Cincinnati, OH: U.S. Environmental Protection Agency, Environmental Monitoring and Support Laboratory. EPA600479020.

EPA. 1983a. Methods for chemical analysis of water and wastes. Method 213.1 (Atomic absorption, direct aspiration). Cincinnati, OH: U.S. Environmental Protection Agency, Office of Research and Development, Environmental Monitoring and Support Laboratory. EPA600479020.

EPA. 1983b. Methods for chemical analysis of water and wastes. Method 213.2 (Atomic absorption, furnace technique). Cincinnati, OH: U.S. Environmental Protection Agency, Office of Research and Development, Environmental Monitoring and Support Laboratory. EPA600479020.

9. REFERENCES

- EPA. 1983c. Treatability manual. Vol. I. Treatability data. Washington, DC: U.S. Environmental Protection Agency, Office of Research and Development. EPA600282001a.
- EPA. 1985a. Cadmium contamination of the environment: An assessment of nationwide risk. Washington, DC: U.S. Environmental Protection Agency, Office of Water Regulations and Standards. EPA 440485023.
- *EPA. 1985b. Summary of environmental profiles and hazard indices for constituents of municipal sludge. Washington, DC: U.S. Environmental Protection Agency, Office of Water Regulations and Standards, Wastewater Solids Criteria Branch.
- *EPA. 1986a. Test methods for evaluating solid waste. 3rd ed. SW-846. U.S. Environmental Protection Agency, Office of Solid Waste and Emergency Response.
- *EPA. 1986b. Reportable quantity. U.S. Environmental Protection Agency. Code of Federal Regulations. 40 CFR 117.3.
- *EPA. 1986c. Cadmium: Atomic absorption, furnace method. Method 7131. In: Test methods for evaluating solid waste. Washington, DC: U.S. Environmental Protection Agency, Office of Solid Waste and Emergency Response. SW-846, 206-209.
- EPA. 1986d. General pretreatment regulations: 65 toxic pollutants. U.S. Environmental Protection Agency. Code of Federal Regulations. 40 CFR 403, Appendix B.
- EPA. 1986e. Method 7130. Cadmium (atomic absorption, direct aspiration). In: Test methods for evaluating solid waste. Volume 1A: Laboratory manual physical/chemical methods. Washington, DC: U.S. Environmental Protection Agency. SW-846.
- *EPA. 1989a. . New source performance standards for sewage treatment plants: Test methods and procedures. U.S. Environmental Protection Agency. Code of Federal Regulations. 40 CFR 60.154.
- *EPA. 1989b. Reportable quantities. U.S. Environmental Protection Agency. Code of Federal Regulations. 40 CFR 302.4.
- *EPA. 1989c. Interim methods for development of inhalation reference doses. Washington, DC: U.S. Environmental Protection Agency, Office of Health and Environmental Assessment. EPA600888066F.
- EPA. 1989d. Recognition and management of pesticide poisonings. Fourth edition. Washington, DC: U.S. Environmental Protection Agency. EPA540988001, 109-111.
- EPA. 1990a. National Pollutant Discharge Elimination System: Stormwater discharges. U.S. Environmental Protection Agency. Code of Federal Regulations. 40 CFR 122.26.
- *EPA. 1990b. Precision and recovery statements for methods for measuring metals. U.S. Environmental Protection Agency. Code of Federal Regulations. 40 CFR 136, Appendix D.
- *EPA. 1990c. Toxic Chemical Release Reporting Rule. U.S. Environmental Protection Agency. Code of Federal Regulations. 40 CFR 372.65.

9. REFERENCES

EPA. 1990d. Interim methods for development of inhalation reference concentrations. Washington, DC: U.S. Environmental Protection Agency, Office of Health and Environmental Assessment, Office of Research and Development, Environmental Criteria and Assessment Office. EPA600/8-90066A.

*EPA. 1991a. Criteria to classify solid waste and disposal facilities: Maximum contaminant levels. U.S. Environmental Protection Agency. Code of Federal Regulations. 40 CFR 257, Appendix I.

*EPA. 1991b. Design criteria for municipal waste landfills. U.S. Environmental Protection Agency. Code of Federal Regulations. 40 CFR 258.40.

EPA. 1991c. Constituents for detection monitoring. U.S. Environmental Protection Agency. Code of Federal Regulations. 40 CFR 258, Appendix I.

EPA. 1993a. Effluent guidelines for offshore oil and gas extraction. U.S. Environmental Protection Agency. Code of Federal Regulations. 40 CFR 435.13 and 15.

*EPA. 1993b. National listing of state fish and shellfish consumption advisories and bans. U.S. Environmental Protection Agency. Research Triangle Institute, NC: Fish Contamination Section, Office of Science and Technology, Office of Water, U.S. Environmental Protection Agency.

EPA. 1993c. Incineration pollutant limits. U.S. Environmental Protection Agency. Code of Federal Regulations. 40 CFR 46-47.

EPA. 1994a. Methods for derivation of inhalation reference concentrations and application of inhalation dosimetry. Washington, DC: U.S. Environmental Protection Agency, Office of Research and Development. EPA600/8-90066F.

EPA. 1994b. Method 200.7: Determination of metals and trace elements in water and wastes by inductively coupled plasma-atomic emission spectrometry. Cincinnati, OH: U.S. Environmental Protection Agency, Office of Research and Development.

EPA. 1996a. Method 1637: Determination of trace elements in ambient waters by off-line chelation preconcentration and stabilized temperature graphite furnace atomic absorption. Washington, DC: U.S. Environmental Protection Agency, Office of Water.

EPA. 1996b. Method 1638: Determination of trace elements in ambient waters by inductively coupled plasma - mass spectrometry. Washington, DC: U.S. Environmental Protection Agency, Office of Water. <http://www.p2pays.org/ref/5C06/05111.pdf>. May 13, 2008.

EPA. 1997a. Special report on environmental endocrine disruption: An effects assessment and analysis. Washington, DC: U.S. Environmental Protection Agency, Risk Assessment Forum. EPA630R96012.

EPA. 1997b. Method 1640: Determination of trace elements in water by preconcentration and inductively coupled plasma - mass spectrometry. Washington, DC: U.S. Environmental Protection Agency, Office of Water. <http://www.epa.gov/waterscience/methods/method/files/1640.pdf>. May 14, 2008.

EPA. 1998. Notice of availability of draft RCRA waste minimization PBT chemical list. U.S. Environmental Protection Agency. Fed Regist 63:60332. <http://www.gpoaccess.gov/fr/index.html>. May 05, 2008.

9. REFERENCES

- EPA. 2000. Method 6010C: Inductively coupled plasma-atomic emission spectrometry. Washington, DC: U.S. Environmental Protection Agency. <http://epa.gov/sw-846/pdfs/6010c.pdf>. May 13, 2008.
- *EPA. 2003a. National primary drinking water standards. Washington, DC: U.S. Environmental Protection Agency, Office of Ground Water and Drinking Water. EPA816F03016. <http://www.epa.gov/safewater/mcl.html>. March 07, 2006.
- EPA. 2003b. Method 200.5: Determination of trace elements in drinking water by axially viewed inductively coupled plasma - atomic emission spectrometry. Cincinnati, OH: U.S. Environmental Protection Agency, Office of Research and Development. EPA600R06115. http://www.epa.gov/nerlcwww/m_200_5.pdf. May 13, 2008.
- EPA. 2005. Toxic chemical release inventory reporting forms and instructions: Revised 2004 version. Section 313 of the Emergency Planning and Community Right-to-Know Act (Title III of the Superfund Amendments and Reauthorization Act of 1986). Washington, DC: U.S. Environmental Protection Agency. Office of Environmental Information. EPA260B05001.
- EPA. 2006a. Consumer factsheet on: Cadmium. U.S. Environmental Protection Agency. http://www.epa.gov/OGWDW/contaminants/dw_contamfs/cadmium.html. April 29, 2008.
- EPA. 2006b. Technical factsheet on cadmium: Ground water and drinking water. <http://www.epa.gov/OGWDW/dwh/t-ioc/cadmium.html>. July 28, 2008.
- EPA. 2007. The Clean Air Act amendments of 1990 list of hazardous air pollutants. U.S. Environmental Protection Agency. United States Code.42 USC 7412. <http://www.epa.gov/ttn/atw/orig189.html>. April 24, 2008.
- *EPA. 2008a. Acute exposure guideline levels (AEGLs). Second AEGL Chemical Priority List. Washington, DC: U.S. Environmental Protection Agency, Office of Pollution Prevention and Toxics. http://www.epa.gov/oppt/aegl/pubs/priority_2.htm. April 24, 2008.
- EPA. 2008b. Designation of hazardous substances. U.S. Environmental Protection Agency. Code of Federal Regulations. 40 CFR 116.4. <http://www.epa.gov/lawsregs/search/40cfr.html>. April 24, 2008.
- EPA. 2008c. Determination of reportable quantities. U.S. Environmental Protection Agency. Code of Federal Regulations. 40 CFR 117.3. <http://www.epa.gov/lawsregs/search/40cfr.html>. April 24, 2008.
- EPA. 2008d. Groundwater monitoring list. U.S. Environmental Protection Agency. Code of Federal Regulations. 40 CFR 264, Appendix IX. <http://www.epa.gov/lawsregs/search/40cfr.html>. May 05, 2008.
- EPA. 2008e. Designation of hazardous substances. U.S. Environmental Protection Agency. Code of Federal Regulations. 40 CFR 302.4 <http://www.epa.gov/lawsregs/search/40cfr.html>.
- EPA. 2008f. The list of extremely hazardous substances and their threshold planning quantities. U.S. Environmental Protection Agency. Code of Federal Regulations. 40 CFR 355, Appendix A. <http://www.epa.gov/lawsregs/search/40cfr.html>. April 24, 2008.
- EPA. 2008g. Toxic chemical release reporting. Chemicals and chemical categories to which this part applies. U.S. Environmental Protection Agency. Code of Federal Regulations. 40 CFR 372.65. <http://www.epa.gov/lawsregs/search/40cfr.html>. April 24, 2008.

9. REFERENCES

- EPA. 2008h. Toxic pollutants. U.S. Environmental Protection Agency. Code of Federal Regulations. 40 CFR 401.15. <http://www.epa.gov/lawsregs/search/40cfr.html>. April 24, 2008.
- EPA. 2009a. Targeted national sewage sludge survey sampling and analysis technical report. Washington, DC: U.S. Environmental Protection Agency. http://water.epa.gov/scitech/wastetech/biosolids/upload/2009_01_15_biosolids_tnsss-tech.pdf. September 10, 2012.
- EPA. 2009b. National primary drinking water regulations. U.S. Environmental Protection Agency, Office of Ground Water. EPA816F090004. <http://water.epa.gov/drink/contaminants/upload/mcl-2.pdf>. February 22, 2012.
- EPA. 2011. Pollutant limits. U.S. Environmental Protection Agency. Code of Federal Regulations 40 CFR 503.13 <http://www.gpo.gov/fdsys/pkg/CFR-2011-title40-vol30/pdf/CFR-2011-title40-vol30-part503.pdf>. September 10, 2012.
- EPA. 2011b. 2011 Edition of the drinking water standards and health advisories. Washington, DC: U.S. Environmental Protection Agency, Office of Water. EPA822R06013. PB2007101258. <http://www.epa.gov/waterscience/criteria/drinking/dwstandards.pdf>. February 22, 2012.
- Epstein SS, Arnold E, Andrea J, et al. 1972. Detection of chemical mutagens by the dominant lethal assay in the mouse. *Toxicol Appl Pharmacol* 23:288-325.
- Espinosa Almendro JM, Ojeda CB, de Torres AG, et al. 1992. Determination of cadmium in biological samples by inductively coupled plasma atomic emission spectrometry after extraction with 1,5-bis(di-2-pyridylmethylene) thiocarbonohydrazide. *Analyst* 117(11):1749-1751.
- Eum, KD; Lee, MS; Paek, D. 2008. Cadmium in blood and hypertension. *Sci Total Environ* 407(1):147-153.
- European Chemicals Bureau. 2007. European union risk assessment report. Cadmium metal and cadmium oxide. Luxembourg: European Chemicals Bureau, Institute for Health and Consumer Protection.
- *Evans J, Hastings L. 1992. Accumulation of Cd(II) in the CNS depending on the route of administration: Intraperitoneal, intratracheal, or intranasal. *Fundam Appl Toxicol* 19:275-278.
- Everett CJ, Frithsen IL. 2008. Association of urinary cadmium and myocardial infarction. *Environ Res* 106(2):284-286.
- Ewers U, Brockhaus A, Dolgner R, et al. 1985. Environmental exposure to cadmium and renal function of elderly women living in cadmium-polluted areas of the Federal Republic of Germany. *Int Arch Occup Environ Health* 55:217-239.
- Exon JH, Koller LD, Kerkvliet NI. 1986. Tissue residues, pathology- and viral-induced mortality in mice chronically exposed to different cadmium salts. *J Environ Pathol Toxicol Oncol* 7:109-114.
- Eybl V, Kotyzova D, Koutensky J, et al. 1994. Effect of chelators, monoisoamyl meso-2,3-dimercaptosuccinate and N-(4-methylbenzyl)-4-0-(B-D-galactopyranosyl)-D-glucamine-N-carbodithioate, on cadmium and essential element levels in mice. *Analyst* 120:855-857.

9. REFERENCES

- Ezaki T, Tsukahara T, Moriguchi J, et al. 2003. No clear-cut evidence for cadmium-induced renal tubular dysfunction among over 10,000 women in the Japanese general population: A nationwide large-scale survey. *Int Arch Occup Environ Health* 76(3):186-196.
- *Fagher U, Laudanski T, Schutz A, et al. 1993. The relationship between cadmium and lead burdens and preterm labor. *Int J Gynaecol Obstet* 40(22):109-114.
- Fahmy MA, Aly FA. 2000. *In vivo* and *in vitro* studies on the genotoxicity of cadmium chloride in mice. *J Appl Toxicol* 20(3):231-238.
- Falck FY, Fine LJ, Smith RG, et al. 1983. Occupational cadmium exposure and renal status. *Am J Ind Med* 4:541-549.
- Farnsworth M. 1980. Cadmium chemicals. 1st ed. New York, NY: International Lead Zinc Research Organization, Inc.
- Fatur T, Tusek M, Falnoga I, et al. 2002. DNA damage and metallothionein synthesis in human hepatoma cells (HepG2) exposed to cadmium. *Food Chem Toxicol* 40(8):1069-1076.
- *Favino A, Candura F, Chiappino G, et al. 1968. Study on the androgen function of men exposed to cadmium. *Med Lav* 59:105-110.
- FDA. 2007. Beverages. Bottled water. U.S. Food and Drug Administration. Code of Federal Regulations. 21 CFR 165.110. <http://www.accessdata.fda.gov/scripts/cdrh/cfdocs/cfcfr/CFRSearch.cfm>. April 24, 2008.
- FDA. 2008. EAFUS: A food additive database. U.S. Food and Drug Administration. <http://vm.cfsan.fda.gov/~dms/eafus.html>. April 24, 2008.
- FDA. 2010. Total diet study statistics on elemental results. Market baskets 2006-1 through 2008-4. College Park, MD: U.S. Food and Drug Administration. <http://www.fda.gov/downloads/Food/FoodSafety/FoodContaminantsAdulteration/TotalDietStudy/UCM184301.pdf>. February 22, 2012.
- FEDRIP. 2008. Cadmium. Federal Research in Progress database. Springfield, VA: National Technical Information Service. April 27, 2008.
- FEDRIP. 2012. Cadmium. Federal Research in Progress database. Springfield, VA: National Technical Information Service. September 2012.
- Feijtel TC, Delne RD, Patrick WH Jr. 1988. Biogeochemical control on metal distribution and accumulation in Louisiana sediments. *J Environ Qual* 17:88-94.
- Ferraro PM, Costanzi S, Naticchia A, et al. 2010. Low level exposure to cadmium increases the risk of chronic kidney disease: Analysis of the NHANES 1999-2006. *BMC Public Health* 10:304.
- Filipic M, Hei TK. 2004. Mutagenicity of cadmium in mammalian cells: Implication of oxidative DNA damage. *Mutat Res* 546(1-2):81-91.
- Fingerle H, Fischer G, Classen HG. 1982. Failure to produce hypertension in rats by chronic exposure to cadmium. *Food Chem Toxicol* 20:301-306.

9. REFERENCES

- Flanagan PR, McLellan J, Haist J, et al. 1978. Increased dietary cadmium absorption in mice and human subjects with iron deficiency. *Gastroenterology* 74:841-846.
- Fomon SJ. 1966. Body composition of the infant. Part I. The male reference infant. In: Falkner F, ed. *Human development*. Philadelphia, PA: WB Saunders, 239-246.
- Fomon SJ, Haschke F, Ziegler EE, et al. 1982. Body composition of reference children from birth to age 10 years. *Am J Clin Nutr* 35:1169-1175.
- Forbes GB, Bruining GJ. 1976. Urinary creatinine excretion and lean body mass. *Am J Clin Nutr* 29:1359-1366.
- Forrester JW. 1968. *Principles of systems*. Cambridge: Wright-Allen Press.
- Foulkes EC. 1978. Renal tubular transport of cadmium-metallothionein. *Toxicol Appl Pharmacol* 45:505-512.
- Foulkes EC. 1980. Some determinants of intestinal cadmium transport in the rat. *J Environ Pathol Toxicol* 3:471-481.
- Foulkes EC. 1984. Intestinal absorption of heavy metals. In: Csaky TZ, ed. *Handbook of experimental pharmacology*. Vol. 70/I. Pharmacology of intestinal permeation. Berlin: Springer Verlag, 543-565.
- Foulkes EC. 1985. Interactions between metals in rat jejunum: Implications on the nature of cadmium uptake. *Toxicology* 37:117-125.
- Foulkes EC. 1989. On the mechanism of cellular cadmium uptake. *Biol Trace Element Res* 21:195-200.
- Foulkes EC, Blanck S. 1990. Acute cadmium uptake by rabbit kidneys: Mechanism and effects. *Toxicol Appl Pharmacol* 102:464-473.
- *Foulkes EC, McMullen DM. 1986. Endogenous metallothionein as determinant of intestinal cadmium absorption: A reevaluation. *Toxicology* 38:285-291.
- Foulkes EC, Voner C. 1981. Effects of Zn status, bile and other endogenous factors on jejunal Cd absorption. *Toxicology* 22:115-122.
- Fox MR, Jacobs RM, Jones AO, et al. 1979. Effects of nutritional factors on metabolism of dietary cadmium at levels similar to those of man. *Environ Health Perspect* 28:107-114.
- Frant S, Kleeman I. 1941. Cadmium "food-poisoning." *JAMA* 117:86-89.
- Frazier J. 1994. Need for physiologically based toxicokinetic models in estimating target organ dosage following oral ingestion of cadmium. In: Wang RGM, ed. *Water contamination and health*. New York, NY: Marcel Dekker, Inc., 281-304.
- Frery N, Girard F, Moreau T, et al. 1993. Validity of hair cadmium in detecting chronic cadmium exposure in general populations. *Bull Environ Contam Toxicol* 50:736-743.

9. REFERENCES

- Friberg L. 1950. Health hazards in the manufacture of alkaline accumulators with special reference to chronic cadmium poisoning. *Acta Med Scand* 138(Suppl 240):1-124.
- Friberg L, Piscator M, Nordberg GF, et al., eds. 1974. *Cadmium in the environment*. 2nd ed. Boca Raton, FL: CRC Press, 23-91.
- Fu JY, Huang XS, Zhu XQ. 1999. Study on peripheral blood lymphocytes chromosome abnormality of people exposed to cadmium in environment. *Biomed Environ Sci* 12(1):15-19.
- Galal-Gorchev H. 1993. Dietary intake, levels in food and estimated intake of lead, cadmium and mercury. *Food Addit Contam* 10(1):115-128.
- Galicia-García V, Rojas-Lopez M, Rios C. 1995. Cadmium levels in maternal, cord and newborn blood in Mexico City newborns. *Toxicologist* 15(1):308.
- Galicia-García V, Rojas-Lopez M, Rojas R, et al. 1997. Cadmium levels in maternal, cord and newborn blood in Mexico City. *Toxicol Lett* 91(1):57-61.
- Gallagher CM, Kovach JS, Meliker JR. 2008. Urinary cadmium and osteoporosis in U.S. Women ≥ 50 years of age: NHANES 1988-1994 and 1999-2004. *Environ Health Perspect* 116(10):1338-1343.
- Gambrell RP. 1994. Trace and toxic metals in wetlands, a review. *J Environ Qual* 23:883-891.
- Gamo M, Ono K, Nakanishi J. 2006. Meta-analysis for deriving age- and gender-specific dose-response relationships between urinary cadmium concentration and β_2 -microglobulinuria under environmental exposure. *Environ Res* 101(1):104-112.
- Gartrell MJ, Craun JC, Podrebarac DS, et al. 1986. Pesticides, selected elements, and other chemicals in adult total diet samples, October 1980 - March 1982. *J Assoc Off Anal Chem* 69:146-161.
- Gasiorek K, Bauchinger M. 1981. Chromosome changes in human lymphocytes after separate and combined treatment with divalent salts of lead, cadmium, and zinc. *Environ Mutagen* 3:513-518.
- Gatta A, Bazzlerla G, Amodio P, et al. 1989. Detection of the early steps of cadmium nephropathy-comparison of light- and electron-microscopical patterns with the urinary enzymes excretion: An experimental study. *Nephron* 51:20-24.
- Geiger H, Bahner U, Anderes S, et al. 1989. Cadmium and renal hypertension. *J Human Hypertension* 3:23-27.
- Gennart JP, Buchet JP, Roels H, et al. 1992. Fertility of male workers exposed to cadmium, lead, or manganese. *Am J Epidemiol* 135(11):1208-1219.
- Ghezzi I, Toffoletto F, Sesana G, et al. 1985. Behaviour of biological indicators of cadmium in relation to occupational exposure. *Int Arch Occup Environ Health* 55:133-140.
- Gibbs RJ. 1994. Metals in the sediments along the Hudson River estuary. *Environ Int* 20(4):507-516.
- *Gill KD, Pal R, Nath R. 1989a. Effect of cadmium on lipid peroxidation and antioxidant enzymes in undernourished weanling rat brain. *Pharmacol Toxicol* 65:73-77.

9. REFERENCES

- Gill KD, Pal R, Sandhir R, et al. 1989b. Effect of chronic cadmium exposure on lipid composition and peroxidation in liver and kidneys in rats. *Med Sci Res* 17:921-924.
- Gilliavod N, Leonard A. 1975. Mutagenicity tests with cadmium in the mouse. *Toxicology* 5:43-47.
- Girolami JP, Bascands JL, Pecher C, et al. 1989. Renal kallikrein excretion as a distal nephrotoxicity marker during cadmium exposure in rats. *Toxicology* 55:117-129.
- Giwercman A, Carlsen E, Keiding N, et al. 1993. Evidence for increasing incidence of abnormalities of the human testis: A review. *Environ Health Perspect Suppl* 101(2):65-71.
- Glaser U, Hochrainer D, Otto FJ, et al. 1990. Carcinogenicity and toxicity of four cadmium compounds inhaled by rats. *Toxicol Environ Chem* 27:153-162.
- Glaser U, Kloppel H, Hochrainer D. 1986. Bioavailability indicators of inhaled cadmium compounds. *Ecotoxicol Environ Saf* 11:261-271.
- *Glaser SC, Bezlo CT, Glauser EM. 1976. Blood-cadmium levels in normotensive and untreated hypertensive humans. *Lancet* 1:717-718.
- Gochfeld M, Burger J. 1982. Biological concentrations of cadmium in estuarine birds of the New York Bight. *Colonial Waterbirds* 5:116-123.
- Goering PL, Klaassen CD. 1984a. Resistance to cadmium-induced hepatotoxicity in immature rats. *Toxicol Appl Pharmacol* 74:321-329.
- Goering PL, Klaassen CD. 1984b. Tolerance to cadmium-induced hepatotoxicity following cadmium pretreatment. *Toxicol Appl Pharmacol* 74:308-313.
- Goering PL, Klaassen CD. 1984c. Zinc-induced tolerance to cadmium hepatotoxicity. *Toxicol Appl Pharmacol* 74:299-307.
- Goering PL, Klaassen CD. 1985. Mechanism of manganese-induced tolerance to cadmium lethality and hepatotoxicity. *Biochem Pharmacol* 34:1371-1379.
- Goldfrank LR, Flomenbaum NE, Lewin NA, et al. 1990. *Goldfrank's toxicologic emergencies*. 4th ed. Norwalk, CT: Appleton & Lange, 649-652.
- Gompertz D, Chettle DR, Fletcher JG, et al. 1983. Renal dysfunction in cadmium smelters: Relation to *in vivo* liver and kidney cadmium concentrations. *Lancet* 1:1185-1187.
- Goon D, Klaassen CD. 1989. Dosage-dependent absorption of cadmium in the rat intestine measured *in situ*. *Toxicol Appl Pharmacol* 100:41-50.
- Goyer RA, Cherian MG. 1992. Role of metallothionein in human placenta and rats exposed to cadmium. In: Nordberg GF, Herber RFM, Alessio L, eds. *Cadmium in the Human Environment: Toxicity and Carcinogenicity*. Lyon: International Agency for Research on Cancer, 239-247.
- Goyer RA, Miller CR, Zhu SY, et al. 1989. Non-metlothionein-bound cadmium in the pathogenesis of cadmium nephrotoxicity in the rat. *Toxicol Appl Pharmacol* 101:232-244.

9. REFERENCES

- Graham JA, Miller FJ, Daniels MJ, et al. 1978. Influence of cadmium, nickel, and chromium on primary immunity in mice. *Environ Res* 16:77-87.
- Greenberg RR, Gallorini M, Gills TE. 1979. Cadmium analysis by radiochemical neutron activation analysis. *Environ Health Perspect* 28:1-4.
- Greenspan BJ, Morrow PE, Ferin J. 1988. Effects of aerosol exposures to cadmium chloride on the clearance of titanium dioxide from the lungs of rats. *Exp Lung Res* 14:491-500.
- Grose EC, Richards JH, Jaskot RH, et al. 1987. A comparative study of the effects of inhaled cadmium chloride and cadmium oxide: Pulmonary response. *J Toxicol Environ Health* 21:219-232.
- Gross SB, Yeager DW, Middendorf MS. 1976. Cadmium in liver, kidney, and hair of humans, fetal through old age. *J Toxicol Environ Health* 2:153-167.
- Groten JP, Sinkeldam EJ, Luten JB, et al. 1990. Comparison of the toxicity of inorganic and liver-incorporated cadmium: A 4-week feeding study in rats. *Food Chem Toxicol* 28:435-441.
- Gruden N, Matausic S. 1989. Some factors influencing cadmium-manganese interaction in adult rats. *Bull Environ Contam Toxicol* 43:101-106.
- Guillard O, Lauwerys R. 1989. *In vitro* and *in vivo* effect of mercury, lead, and cadmium on the generation of chemiluminescence by human whole blood. *Biochem Pharmacol* 38:2819-2824.
- Gunn SA, Gould TC, Anderson WAD. 1968a. Mechanisms of zinc, cysteine and selenium protection against cadmium-induced vascular injury to mouse testis. *J Reprod Fertil* 15:65-70.
- Gunn SA, Gould TC, Anderson WAD. 1968b. Selectivity of organ response to cadmium and various protective measures. *J Pathol Bacteriol* 96:89-96.
- Gupta A, Gupta A, Murthy RC, et al. 1993. Neurochemical changes in developing rat brain after pre- and postnatal cadmium exposure. *Bull Environ Contam Toxicol* 51:12-17.
- Gutenmann WH, Rutzke M, Kuntz HT, et al. 1994. Elements and polychlorinated biphenyls in sewage sludges of large cities in the United States. *Chemosphere* 28(4):725-728.
- Guzelian PS, Henry CJ, Olin SS, eds. 1992. Similarities and differences between children and adults: Implications for risk assessment. Washington, DC: International Life Sciences Institute Press.
- Haddad LM, Winchester JF. 1990. Clinical management of poisoning and drug overdose. 2nd ed. Philadelphia, PA: WB Sanders Company, 331-332, 1029-1030.
- Hammer DI, Calocci AV, Hasselblad V, et al. 1973. Cadmium and lead in autopsy tissues. *J Occup Med* 15:956-964.
- Handy RD. 1992a. The assessment of episodic metal pollution. I. Uses and limitations of tissue contaminant analysis in rainbow trout (*Oncorhynchus mykiss*) after short waterborne exposure to cadmium or copper. *Arch Environ Contam Toxicol* 22(1):74-81.

9. REFERENCES

- Handy RD. 1992b. The assessment of episodic metal pollution. II. The effects of cadmium and copper enriched diets on tissue contaminant analysis in rainbow trout (*Oncorhynchus mykiss*). Arch Environ Contam Toxicol 22(1):82-87.
- Hansen JC, Wulf HC, Kromann N, et al. 1985. Cadmium concentrations in blood samples from an East Greenlandic population. Dan Med Bull 32:277-279.
- Hardell L, Wing MA, Ljungberg B, et al. 1994. Levels of cadmium, zinc and copper in renal cell carcinoma and normal kidney. Eur J Cancer Prev 3:45-48.
- Harrison SE, Klaverkamp JF. 1990. Metal contamination in liver and muscle of northern pike (*Esox lucius*) and white sucker (*Catostomus commersoni*) and in sediments from lakes near the smelter at Flin Flon, Manitoba. Environ Toxicol Chem 9:941-956.
- Hart BA. 1986. Cellular and biochemical response of the rat lung to repeated inhalation of cadmium. Toxicol Appl Pharmacol 82:281-291.
- Hart BA, Potts RJ, Watkin RD. 2001. Cadmium adaptation in the lung – a double-edged sword? Toxicology 160(1-3):65-70.
- Hart BA, Voss GW, Willean CL. 1989a. Pulmonary tolerance to cadmium following cadmium aerosol pretreatment. Toxicol Appl Pharmacol 101:447-460.
- Hart RP, Rose CS, Hamer RM. 1989b. Neuropsychological effects of occupational exposure to cadmium. J Clin Exper Neuropsychol 11:933-943.
- Hasselbach L, Ver Hoef JM, Ford J, et al. 2005. Spatial patterns of cadmium and lead deposition on and adjacent to National Park Service lands in the vicinity of Red Dog Mine, Alaska. Sci Total Environ 348(1-3):223-229.
- Haswell-Elkins M, Satarug S, O'Rourke P, et al. 2008. Striking association between urinary cadmium level and albuminuria among Torres Strait Islander people with diabetes. Environ Res 106:379-383.
- Hayano M, Nogawa K, Kido T, et al. 1996. Dose-response relationship between urinary cadmium concentration and β_2 -microglobulinuria using logistic regression analysis. Arch Environ Health 51(2):162-167.
- Hays ES, Margaretten N. 1985. Long-term oral cadmium produces bone marrow hypoplasia in mice. Exp Hematol 13:229-234.
- HazDat. 2007. Cadmium. HazDat Database: ATSDR's Hazardous Substance Release and Health Effects Database. Atlanta, GA: Agency for Toxic Substances and Disease Registry.
- He QB, Singh BR. 1994. Crop uptake of cadmium from phosphorus fertilizers. I. Yield and cadmium content. Water Air Soil Pollut 74:251-265.
- Heinrich U, Peters L, Ernst H, et al. 1989. Investigation on the carcinogenic effects of various cadmium compounds after inhalation exposure in hamsters and mice. Exp Pathol 37:253-258.
- Hellström L, Elinder CG, Dahlberg B, et al. 2001. Cadmium exposure and end-stage renal disease. Am J Kidney Dis 38(5): 1001-1008.

9. REFERENCES

- Henderson RF, Rebar AH, Pickrell JA, et al. 1979. Early damage indicators in the lung. III. Biochemical and cytological response of the lung to inhaled metal salts. *Toxicol Appl Pharmacol* 50:123-136.
- Herrero TC, Martin LFL. 1993. Evaluation of cadmium levels in fertilized soils. *Bull Environ Contam Toxicol* 50:61-68.
- Herron N. 2003. Cadmium compounds. *Kirk-Othmer encyclopedia of chemical technology*. Vol. 4. John Wiley & Sons, Inc., 507-523.
<http://mrw.interscience.wiley.com/emrw/9780471238966/kirk/article/cadmherr.a01/current/pdf>. April 29, 2008.
- *Hew KW, Ericson WA, Welsh MJ. 1993a. A single low cadmium dose causes failure of spermiation in the rat. *Toxicol Appl Pharmacol* 121(1):15-21.
- *Hew KW, Heath GL, Jiwa AH, et al. 1993b. Cadmium in vivo causes disruption of tight junction-associated microfilaments in rat Sertoli cells. *Biol Reprod* 49(4):840-849.
- Hirano S, Tsukamoto N, Higo S, et al. 1989a. Toxicity of cadmium oxide instilled into the rat lung. II. Inflammatory in broncho-alveolar lavage fluid. *Toxicology* 55(1-2):25-35.
- Hirano S, Tsukamoto N, Kobayashi E, et al. 1989b. Toxicity of cadmium oxide instilled into the rat lung. I. Metabolism of cadmium oxide in the lung and its effects on essential elements. *Toxicology* 55(1-2):15-24.
- *Hirano S, Tsukamoto N, Suzuki KT. 1990. Biochemical changes in the rat lung and liver following intratracheal instillation of cadmium oxide. *Toxicol Lett* 50:97-105.
- Hiratsuka H, Satoh S-i, Satoh M, et al. 1999. Tissue distribution of cadmium in rats given minimum amounts of cadmium-polluted rice or cadmium chloride for 8 months. *Toxicol Appl Pharmacol* 160:183-191.
- Hoadley JE, Cousins RJ. 1985. Effects of dietary zinc depletion and food restriction on intestinal transport of cadmium in the rat. *Proc Soc Exp Biol Med* 180:296-302.
- Hochi Y, Kido T, Nogawa K, et al. 1995. Dose-response relationship between total cadmium intake and prevalence of renal dysfunction using general linear models. *J Appl Toxicol* 15:109-116.
- Hoel DG, Davis DL, Miller AB, et al. 1992. Trends in cancer mortality in 15 industrialized countries, 1969-1986. *J Natl Cancer Inst* 84(5):313-320.
- *Hoffmann L, Putzke HP, Kampehl HJ, et al. 1985. Carcinogenic effects of cadmium on the prostate of the rat. *J Cancer Res Clin Oncol* 109:193-199.
- *Holloway WR, Thor DH. 1988a. Cadmium exposure in infancy: Effects on activity and social behaviors of juvenile rats. *Neurotoxicol Teratol* 10:135-142.
- *Holloway WR, Thor DH. 1988b. Social memory deficits in adult male rats exposed to cadmium in infancy. *Neurotoxicol Teratol* 10:193-197.

9. REFERENCES

- Holmgren GGS, Meyer MW, Chaney RL, et al. 1993. Cadmium, lead, zinc, copper, and nickel in agricultural soils of the United States of America. *J Environ Qual* 22:335-348.
- Holsen TM, Noll KE, Fang G, et al. 1993. Dry deposition and particle size distributions measured during the Lake Michigan Urban Air Toxics Study. *Environ Sci Technol* 27(7):1327-1333.
- Holt D, Webb M. 1987. Teratogenicity of ionic cadmium in the Wistar rat. *Arch Toxicol* 59:443-447.
- Honda R, Swaddiwudhipong W, Nishijo M, et al. 2010. Cadmium induced renal dysfunction among residents of rice farming area downstream from a zinc-mineralized belt in Thailand. *Toxicol Lett* 198(1):26-32.
- Honma M, Hayashi M, Shimada H, et al. 1999. Evaluation of the mouse lymphoma tk assay (microwell method) as an alternative to the *in vitro* chromosomal aberration test. *Mutagenesis* 14(1):5-22.
- Hopf G, Bocker R, Bischoff, et al. 1990. Investigation of the combined effects of ethanol and cadmium on rat liver and kidneys. *Arch Toxicol* 64:470-473.
- Horiguchi H, Aoshima K, Oguma E, et al. 2010. Latest status of cadmium accumulation and its effects on kidneys, bone, and erythropoiesis in inhabitants of the formerly cadmium-polluted Jinzu River Basin in Toyama, Japan, after restoration of rice paddies. *Int Arch Occup Environ Health* 83(8):953-970.
- Horiguchi H, Oguma E, Sasaki S, et al. 2004. Comprehensive study of the effects of age, iron deficiency, diabetes mellitus, and cadmium burden on dietary cadmium absorption in cadmium-exposed female Japanese farmers. *Toxicol Appl Pharmacol* 196:114-123.
- Hotz P, Buchet JP, Bernard A, et al. 1999. Renal effects of low-level environmental cadmium exposure: 5-year follow-up of a subcohort from the Cadmibel study. *Lancet* 354:1508-1513.
- HSDB. 2008. Cadmium and cadmium compounds. Hazardous Substance Data Bank. National Library of Medicine, Bethesda, MD. May 28, 2008.
- Huel G, Everson RB, Menger I. 1984. Increased hair cadmium in newborns of women occupationally exposed to heavy metals. *Environ Res* 35:115-121.
- Huel G, Ibrahim MA, Boudene C. 1981. Cadmium and lead content of maternal and newborn hair: Relationship to parity, birth weight, and hypertension. *Arch Environ Health* 36:221-227.
- Hwangbo Y, Weaver VM, Tellez-Plaza M, et al. 2011. Blood cadmium and estimated glomerular filtration rate in Korean adults. *Environ Health Perspect* 119:1800-1805.
- IARC. 1993. Cadmium and certain cadmium compounds. In: IARC monographs on the evaluation of the carcinogenic risk of chemicals to humans. Beryllium, cadmium, mercury and exposures in the glass manufacturing industry. IARC monographs, Vol. 58. Lyon, France: World Health Organization. International Agency for Research on Cancer, 119-236.
- IARC. 2008. Agents reviewed by the IARC monographs: Volumes 1-99. Lyon, France: International Agency for Research on Cancer. <http://monographs.iarc.fr/ENG/Classification/index.php>. April 24, 2008.

9. REFERENCES

- ICRP. 1980. Metabolic data for cadmium. Limits for intakes of radionuclides by workers. Protection Pergamon Press, NY: International Commission on Radiological, 42-44. ICRP Publication No. 30, Part 2.
- ICRP. 1981. Report of the task group on reference man. Pergamon Press, NY: International Commission on Radiological Protection, 40-45. ICRP Publication 23.
- ICRP. 1994. Human respiratory tract model for radiological protection. Pergamon Press, Oxford: International Commission on Radiological Protection. ICRP publication 66.
- Iimura K. 1981. Heavy metal problems in paddy soils. In: Kitagishi K, Yamane I, eds. Heavy metal problems in soils of Japan. Japan Scientific Societies Press, 37-50.
- IJC. 1989. 1989 report on Great Lakes water quality. Windsor, Ontario: International Joint Commission, Great Lakes Water Quality Board.
- *Ijomah G, Corrigan FM, Holliday J, et al. 1993. Aluminum, cadmium, lipids and prevalence of dementia in people living near an aluminum smelter. Trace Elements in Medicine 10(1):6-12.
- Ikeda M, Ezaki T, Tsukahara T, et al. 2005a. Reproducibility of urinary cadmium, α -microglobulin, and β_2 -microglobulin levels in health screening of the general population. Arch Environ Contam Toxicol 48(1):135-140.
- Ikeda M, Ezaki T, Moriguchi J, et al. 2005b. The threshold cadmium level that causes a substantial increase in β_2 -microglobulin in urine of general populations. Tohoku J Exp Med 205(3):247-261.
- Ikeda M, Ezaki T, Tsukahara T, et al. 2003a. Bias induced by the use of creatinine-corrected values in evaluation of β_2 -microglobulin levels. Toxicol Lett 145:197-207.
- Ikeda M, Ezaki T, Tsukahara T, et al. 2003b. Threshold levels of urinary cadmium in relation to increases in urinary β_2 -microglobulin among general Japanese populations. Toxicol Lett 137(3):135-141.
- Ikeda M, Watanabe T, Zhang ZW, et al. 1997. The integrity of the liver among people environmentally exposed to cadmium at various levels. Int Arch Occup Environ Health 69(6):379-385.
- Ikeda M, Zhang ZW, Higashikawa K, et al. 1999. Background exposure of general women populations in Japan to cadmium in the environment and possible health effects. Toxicol Lett 108(2-3):161-166.
- Ikeda M, Zhang ZW, Moon CS, et al. 2000. Normal liver function in women in the general Japanese population subjected to environmental exposure to cadmium at various levels. Int Arch Occup Environ Health 73(2):86-90.
- ILZRO. 1977. Biological availability of cadmium from cadmium pigments. New York, NY: International Lead Zinc Research Organization, Inc.
- Inoue Y, Watanabe TK. 1978. Toxicity and mutagenicity of cadmium and furylfuramide in *Drosophila melanogaster*. Jpn J Genetics 53:183-189.
- Inskip H, Beral V, McDowall M. 1982. Mortality of Shipham residents: 40-year follow-up. Lancet:896-899.

9. REFERENCES

- IRIS. 2012. Cadmium. Integrated Risk Information System. Washington, DC: U.S. Environmental Protection Agency. <http://www.epa.gov/iris/subst/index.html>. February 22, 2012.
- Ishizaki M, Kido T, Honda R, et al. 1989. Dose-response relationship between urinary cadmium and β_2 -microglobulin in Japanese environmentally cadmium exposed population. *Toxicology* 58:121-131.
- Itoh H, Iwasaki M, Nakajima Y, et al. 2008. A case-control study of the association between urinary cadmium concentration and endometriosis in infertile Japanese women. *Sci Total Environ* 402(2-3):171-175.
- Itokawa Y, Abe T, Tabei R, et al. 1974. Renal and skeletal lesions in experimental cadmium poisoning. *Arch Environ Health* 28:149-154.
- Iwata K, Katoh T, Morikawa Y, et al. 1988. Urinary trehalase activity as an indicator of kidney injury due to environmental cadmium exposure. *Arch Toxicol* 62:435-439.
- Iwata K, Saito H, Moriyama M, et al. 1993. Renal tubular function after reduction of environmental cadmium exposure: A ten-year follow-up. *Arch Environ Health* 48(3):157-163.
- Iwata K, Saito H, Moriyama M, et al. 1991a. Association between renal tubular dysfunction and mortality among residents in a cadmium-polluted area, Nagasaki, Japan. *Tohoku J Exp Med* 164:93-102.
- Iwata K, Saito H, Nakano A. 1991b. Association between cadmium-induced renal dysfunction and mortality: Further evidence. *Tohoku J Exp Med* 164:319-330.
- *Iwata K, Saito H, Moriyama M, et al. 1992. Follow up study of renal tubular dysfunction and mortality in residents of an area polluted with cadmium. *Br J Ind Med* 49(10):737-737.
- Izuno T, Sugita M, Arita S, et al. 2000. Validity of cadmium concentration in rice as the 'dose' of the dose-response relationship between cadmium intake and renal dysfunction. *Environ Res* 84 Sect A:275-281.
- Jackson LW, Zullo MD, Goldberg JM. 2008. The association between heavy metals, endometriosis and uterine myomas among premenopausal women: National Health and Nutrition Examination Survey 1999-2002. *Hum Reprod* 23(3):679-687.
- Jacquillet G, Barbier O, Rubera I, et al. 2007. Cadmium causes delayed effects on renal function in the offspring of cadmium-contaminated pregnant female rats. *Am J Physiol Renal Physiol* 293(5):F1450-1460.
- Jaeger DE. 1990. Absorption interactions of zinc and cadmium in the isolated perfused rat intestine. *J Trace Elements Electrolytes Health Disease* 4:101-105.
- *Jahn F, Klinger W. 1989. Influence of prenatal administration of cadmium on postnatal development and inducibility of hepatic monooxygenases in rats. *Pharmacol Toxicol* 64:291-292.
- Jakubowski M, Razniewska G, Halatek T, et al. 1992. Integrated index of occupational exposure to cadmium as a predictor of kidney dysfunction. *Cadmium in the human environment: Toxicity and carcinogenicity*. IARC Sci Publ 118:319-324.

9. REFERENCES

- Jakubowski M, Trojanowska B, Kowalska G, et al. 1987. Occupational exposure to cadmium and kidney dysfunction. *Int Arch Occup Environ Health* 59:567-577.
- Jamall IS, Smith JC. 1985a. Effects of cadmium on glutathione peroxidase, superoxide dismutase and lipid peroxidation in the rat heart: A possible mechanism of cadmium cardiotoxicity. *Toxicol Appl Pharmacol* 80:33-42.
- Jamall IS, Smith JC. 1985b. The effects of dietary selenium on cadmium binding in rat kidney and liver. *Arch Toxicol* 56:252-255.
- Jamall IS, Smith JC. 1985c. Effects of cadmium treatment on selenium dependent and selenium independent glutathione peroxidase activities and lipid peroxidation in the kidney and liver of rats maintained on various levels of dietary selenium. *Arch Toxicol* 58:102-105.
- Jamall IS, Naik M, Sprowls JJ, et al. 1989. A comparison of the effects of dietary cadmium on heart and kidney oxidant enzymes: Evidence for the greater vulnerability of the heart to cadmium toxicity. *J Appl Toxicol* 9:339-345.
- *Janecki A, Jakubowiak A, Steinberger A. 1992. Effect of cadmium chloride on transepithelial electrical resistance of Sertoli cell monolayers in two-compartment cultures--a new model for toxicological investigations of the "blood-testis" barrier *in vitro*. *Toxicol Appl Pharmacol* 112(1):51-57.
- Jarrett JM, Xiao G, Caldwell KL, et al. 2008. Eliminating molybdenum oxide interference in urine cadmium biomonitoring using ICP-DRC-MS. *J Anal Atom Spectrom* 23(7):962-967.
- Järup L, Elinder CG. 1993. Incidence of renal stones among cadmium exposed battery workers. *Br J Ind Med* 50:598-602.
- Järup L, Elinder CG. 1994. Dose-response relations between urinary cadmium and tubular proteinuria in cadmium-exposed workers. *Am J Ind Med* 26(6):759-769.
- Järup L, Bellander T, Hogstedt C, et al. 1998a. Mortality and cancer incidence in Swedish battery workers exposed to cadmium and nickel. *Occup Environ Med* 55(11):755-759.
- Järup L, Berglund M, Elinder CG, et al. 1998b. Health effects of cadmium exposure - a review of the literature and a risk estimate. *Scand J Work Environ Health* 24:1-52.
- Järup L, Carlsson MD, Elinder CG, et al. 1995a. Enzymuria in a population living near a cadmium battery plant. *Occup Environ Med* 52:770-772.
- Järup L, Elinder CG, Spang G. 1988. Cumulative blood-cadmium and tubular proteinuria: A dose-response relationship. *Int Arch Occup Environ Health* 60:223-229.
- Järup L, Hellstrom L, Alfven T, et al. 2000. Low level exposure to cadmium and early kidney damage: The OSCAR study. *Occup Environ Med* 57(10):668-672.
- *Järup L, Persson B, Edling C, et al. 1993. Renal function impairment in workers previously exposed to cadmium. *Nephron* 64:75-81.
- Järup L, Persson B, Elinder CG. 1995b. Decreased glomerular filtration rate in solderers exposed to cadmium. *Occup Environ Med* 52:818-822.

9. REFERENCES

- *Jaw S, Jeffery EH. 1988. The effect of dietary zinc status on biliary metal excretion of rats. *J Nutr* 118:1385-1390.
- Jeng SL, Lee SJ, Lin SY. 1994. Determination of cadmium and lead in raw milk by graphite furnace atomic absorption spectrophotometer. *J Dairy Sci* 77:945-949.
- Jensen AA. 1983. Chemical contaminants in human milk. *Residue Reviews* 89:1-128.
- Jianhua Z, Lian X, Shuanlai Z, et al. 2006. DNA lesion and Hprt mutant frequency in rat lymphocytes and V79 Chinese hamster lung cells exposed to cadmium. *J Occup Health* 48(2):93-99.
- Jin T, Nordberg M, Frech W, et al. 2002. Cadmium biomonitoring and renal dysfunction among a population environmentally exposed to cadmium from smelting in China. *Biomaterials* 15:397-410.
- Jin T, Nordberg G, Xunwei W, et al. 1999. Urinary *N*-acetyl- β -D-glucosaminidase isoenzymes as biomarker of renal dysfunction caused by cadmium in general population. *Environ Res* 81(2):167-173.
- Jin T, Kong Q, Ye T, et al. 2004a. Renal dysfunction of cadmium-exposed workers residing in a cadmium-polluted environment. *Biomaterials* 17(5):513-518.
- Jin T, Nordberg G, Ye T, et al. 2004c. Osteoporosis and renal dysfunction in a general population exposed to cadmium in China. *Environ Res* 96(3):353-359.
- Jin T, Wu X, Tang Y, et al. 2004b. Environmental epidemiological study and estimation of benchmark dose for renal dysfunction in a cadmium-polluted area in China. *Biomaterials* 17(5):525-530.
- Johanson CE. 1980. Permeability and vascularity of the developing brain: Cerebellum vs. cerebral cortex. *Brain Res* 190(1):3-16.
- Johansson A, Curstedt T, Robertson B, et al. 1984. Lung morphology and phospholipids after experimental inhalation of soluble cadmium, copper, and cobalt. *Environ Res* 34:295-309.
- John J, Gjessing ET, Grande M, et al. 1987. Influence of aquatic humus and pH on the uptake and depuration of cadmium by the Atlantic salmon (*Salmo salar L.*). *Sci Total Environ* 62:253-265.
- Jonah MM, Bhattacharyya MH. 1989. Early changes in the tissue distribution of cadmium after oral but not intravenous cadmium exposure. *Toxicology* 58:325-338.
- Jones MM, Cherian MG. 1990. The search for chelate antagonists for chronic cadmium intoxication. *Toxicology* 62:1-25.
- Jones MM, Singh PK, Basinger MA, et al. 1994. Cadmium mobilization by monoalkyl- and monoalkyl esters of meso-2,3-dimercaptosuccinic acid and by a dithiocarbamate. *Pharmacol Toxicol* 74:76-83.
- Jones MM, Singh PK, Gale GR, et al. 1992. Cadmium mobilization *in vivo* by intraperitoneal or oral administration of monoalkyl esters of meso-2,3-dimercaptosuccinic acid in the mouse. *Pharmacol Toxicol* 70:336-343.

9. REFERENCES

- Jurasović J, Cvitkovic P, Pizent A, et al. 2004. Semen quality and reproductive endocrine function with regard to blood cadmium in Croatian male subjects. *Biometals* 17(6):735-743.
- Kagamimori S, Watanabe M, Nakagawa H, et al. 1986. Case-control study on cardiovascular function in females with a history of heavy exposure to cadmium. *Bull Environ Contam Toxicol* 36:484-490.
- *Kahan E, Derazne E, Rosenboim J, et al. 1992. Adverse health effects in workers exposed to cadmium. *Am J Ind Med* 21:527-537.
- Kalac P, Niznanska M, Bevilaqua D, et al. 1996. Concentrations of mercury, copper, cadmium and lead in fruiting bodies of edible mushrooms in the vicinity of a mercury smelter and a copper smelter. *Sci Total Environ* 177(1-3):251-258.
- Kalahasthi RB, Rajmohan H, Rajan B, et al. 2007. Urinary N-acetyl-beta -D-glucosaminidase and its isoenzymes A & B in workers exposed to cadmium at cadmium plating. *J Occup Med Toxicol* 2(5):1-7.
- Kamenosono T, Shimada H, Funakoshi T, et al. 2002a. Involvement of active transport systems in the mobilization of cadmium by dithiocarbamates *in vivo*. *Toxicology* 170(1-2):103-110.
- *Kamenosono T, Shimada H, Funakoshi T, et al. 2002b. Structure-effect relationship in the mobilization of cadmium in mice by several dithiocarbamates. *Comp Biochem Physiol C* 132(1):61-66.
- Kanematsu N, Hara M, Kada T. 1980. Rec-assay and mutagenicity studies on metal compounds. *Mutat Res* 77:109-116.
- Kanisawa M, Schroeder HA. 1969. Life term studies on the effects of trace elements on spontaneous tumors in mice and rats. *Cancer Res* 29:892-895.
- Kaplan M, Atakan IH, Aydogdu N, et al. 2008. Influence of N-acetylcysteine on renal toxicity of cadmium in rats. *Pediatr Nephrol* 23(2):233-241.
- Kar AB, Das RP, Mukerji B. 1960. Prevention of cadmium induced changes in the gonads of rats by zinc and selenium-A study in antagonism between metals in the biological system. *Proc Natl Inst Sci India. Part B. Biol Sci* 26:40-50.
- Karakaya A, Yucesoy B, Sardas OS. 1994. An immunological study on workers occupationally exposed to cadmium. *Human Exp Toxicol* 13:73-75.
- Karmakar R, Banik S, Bandyopadhyay S, et al. 1998. Cadmium-induced alterations of hepatic lipid peroxidation, glutathione S-transferase activity and reduced glutathione level and their possible correlation with chromosomal aberration in mice: A time course study. *Mutat Res* 397(2):183-190.
- Kasuba V, Rozgaj R. 2002. Micronucleus distribution in human peripheral blood lymphocytes treated *in vitro* with cadmium chloride in G₀ and S phase of the cell cycle. *Chemosphere* 49(1):91-95.
- Kasuba V, Rozgaj R, Saric MM, et al. 2002. Evaluation of genotoxic damage of cadmium chloride in peripheral blood of suckling Wistar rats. *J Appl Toxicol* 22(4):271-277.
- Katskov DA, Schwrzer R, Pieter JJG, et al. 1994. Use of a furnace with a graphite filter for electrothermal atomic absorption spectrometry. *J Anal Atom Spectrom* 9:431-436.

9. REFERENCES

- Kawada T, Koyama H, Suzuki S. 1989. Cadmium, NAG activity, and B₂-microglobulin in the urine of cadmium pigment workers. *Br J Ind Med* 46:52-55.
- Kawada T, Shinmyo RR, Suzuki S. 1992. Urinary cadmium and *N*-acetyl- β -D-glucosaminidase excretion of inhabitants living in a cadmium-polluted area. *Int Arch Occup Environ Health* 63:541-546.
- Kawada T, Tohyama C, Suzuki S. 1990. Significance of the excretion of urinary indicator proteins for a low level of occupational exposure to cadmium. *Int Arch Occup Environ Health* 62:95-100.
- Kawamura J, Yoshida O, Nishino K, et al. 1978. Disturbances in kidney functions and calcium and phosphate metabolism in cadmium-poisoned rats. *Nephron* 20:101-110.
- *Kawashima H, Nomiyama H, Nomiyama K. 1988. Chronic exposure to cadmium did not impair vitamin D metabolism in monkeys. *Environ Res* 46:48-58.
- Kazantzis G. 1979. Renal tubular dysfunction and abnormalities of calcium metabolism in cadmium workers. *Environ Health Perspect* 28:155-159.
- Kazantzis G, Blanks RG, Sullivan KR. 1992. Is cadmium a human carcinogen? In: Nordberg GF, Herber RFM, Alessio L, eds. *Cadmium in the human environment: Toxicity and carcinogenicity*. IARC Scientific Publications No. 118. Lyon, France: International Agency for Research on Cancer, 435-446.
- Kazantzis G, Lam TH, Sullivan KR. 1988. Mortality of cadmium-exposed workers. A five-year update. *Scand J Work Environ Health* 14:220-223.
- Kelman BJ, Walter BK, Jarboe GE, et al. 1978. Effect of dietary cadmium on calcium metabolism in the rat during late gestation. *Proc Soc Exp Biol Med* 158:614-617.
- Kershaw WC, Iga T, Klaassen CD. 1990. Ethanol decreases cadmium hepatotoxicity in rats: Possible role of hepatic metallothionein induction. *Toxicol Appl Pharmacol* 106:448-455.
- Kido T, Nogawa K. 1993. Dose-response relationship between total cadmium intake and β_2 -microglobulinuria using logistic regression analysis. *Toxicol Lett* 69:113-120.
- Kido T, Honda R, Tsuritani I, et al. 1988. Progress of renal dysfunction in inhabitants environmentally exposed to cadmium. *Arch Environ Health* 43:213-217.
- *Kido T, Honda R, Tsuritani I, et al. 1989a. High urinary cadmium concentration in a case of gastric cancer. *Br J Ind Med* 46:288.
- Kido T, Nogawa K, Honda R, et al. 1990a. The association between renal dysfunction and osteopenia in environmental cadmium-exposed subjects. *Environ Res* 51:71-82.
- Kido T, Nogawa K, Ishizaki M, et al. 1990b. Long-term observation of serum creatinine and arterial blood pH in persons with cadmium-induced renal dysfunction. *Arch Environ Health* 45:35-41.
- Kido T, Nogawa K, Yamada Y, et al. 1989b. Osteopenia in inhabitants with renal dysfunction induced by exposure to environmental cadmium. *Int Arch Occup Environ Health* 61:271-276.
- Kido T, Sunaga K, Nishijo M, et al. 2004. The relation of individual cadmium concentration in urine with total cadmium intake in Kakehashi River basin, Japan. *Toxicol Lett* 152(1):57-61.

9. REFERENCES

- Kim DW, Kim KY, Choi BS, et al. 2007. Regulation of metal transporters by dietary iron, and the relationship between body iron levels and cadmium uptake. *Arch Toxicol* 81:327-334.
- Kimura M, Otaki N. 1972. Percutaneous absorption of cadmium in rabbit and hairless mouse. *Ind Health* 10:7-10.
- Kimura M, Otaki N, Yoshiki S, et al. 1974. The isolation of metallothionein and its protective role in cadmium poisoning. *Arch Biochem Biophys* 165:340-348.
- Kipling MD, Waterhouse JAH. 1967. Cadmium and prostatic carcinoma. *Lancet* 1(7492):730-731.
- *Kjellström T. 1986a. Critical organs, critical concentrations, and whole-body dose-response relationships. In: Friberg L, Elinder CG, Kjellström T, et al., eds. *Cadmium and health: A toxicological and epidemiological appraisal*. Vol. II. Effects and response. Boca Raton, FL: CRC Press, 231-246.
- *Kjellström T. 1986b. Effects on bone, on vitamin D, and calcium metabolism. In: Friberg L, Elinder CG, Kjellström T, et al., eds. *Cadmium and health: A toxicological and epidemiological appraisal*. Vol. II. Effects and response. Boca Raton, FL: CRC Press, 111-158.
- Kjellström T. 1986c. Renal effects. In: Friberg L, Elinder CG, Kjellström T, et al., eds. *Cadmium and health: A toxicological and epidemiological appraisal*. Vol. II. Effects and response. Boca Raton, FL: CRC Press, 21-110.
- Kjellström T, Nordberg GF. 1978. A kinetic model of cadmium metabolism in the human being. *Environ Res* 16:248-269.
- Kjellström T, Nordberg GF. 1985. Kinetic model of cadmium metabolism. In: Friberg L, Elinder CG, Kjellström T, et al., eds. *Cadmium and health: A toxicological and epidemiological appraisal*. Vol. I. Exposure, dose and metabolism. Boca Raton, FL: CRC Press, 179-197.
- Kjellström T, Borg K, Lind B. 1978. Cadmium in feces as an estimator of daily cadmium intake in Sweden. *Environ Res* 15:242-251.
- Kjellström T, Evrin PE, Rahnster B. 1977a. Dose-response analysis of cadmium-induced tubular proteinuria. A study of urinary beta-2-microglobulin excretion among workers in a battery factory. *Environ Res* 13:303-317.
- Kjellström T, Friberg L, Rahnster B. 1979. Mortality and cancer morbidity among cadmium-exposed workers. *Environ Health Perspect* 28:199-204.
- *Kjellström T, Shiroisky K, Evrin PE. 1977b. Urinary β_2 -microglobulin excretion among people exposed to cadmium in the general environment. An epidemiological study in cooperation between Japan and Sweden. *Environ Res* 13:318-344.
- Klaassen CD. 1978. Effect of metallothionein on hepatic disposition of metals. *Am J Physiol* 234:E47-E53.
- Klaassen CD, Kotsonis FN. 1977. Biliary excretion of cadmium in the rat, rabbit, and dog. *Toxicol Appl Pharmacol* 41:101-112.

9. REFERENCES

- Klemm W, Bombach G. 1995. Trace element determination in contaminated sediments and soils by ultrasonic slurry sampling and Zeeman graphite furnace atomic absorption spectrometry. *Fresenius J Anal Chem* 353(1):12-15.
- Klimisch HJ. 1993. Lung deposition, lung clearance and renal accumulation of inhaled cadmium chloride and cadmium sulphide in rats. *Toxicology* 84:103-124.
- Kobayashi E, Okubo Y, Suwazono Y, et al. 2002a. Association between urinary calcium excretion level and mortality in inhabitants of the Jinzu River basin area of Japan. *Biol Trace Elem Res* 89:145-153.
- Kobayashi E, Okubo Y, Suwazono Y, et al. 2002b. Dose-response relationship between total cadmium intake calculated from the cadmium concentration in rice collected from each household of farmers and renal dysfunction in inhabitants of the Jinzu River basin, Japan. *J Appl Toxicol* 22(6):431-436.
- Kobayashi E, Suwazono Y, Dochi M, et al. 2008a. Estimation of benchmark doses as threshold levels of urinary cadmium, based on excretion of beta2-microglobulin in cadmium-polluted and non-polluted regions in Japan. *Toxicol Lett* 179(2):108-112.
- Kobayashi E, Suwazono Y, Dochi M, et al. 2009a. Association of lifetime cadmium intake or drinking Jinzu River water with the occurrence of renal tubular dysfunction. *Environ Toxicol* 24(5):421-428.
- Kobayashi E, Suwazono Y, Dochi M, et al. 2009b. Influence of consumption of cadmium-polluted rice or Jinzu River water on occurrence of renal tubular dysfunction and/or Itai-itai disease. *Biol Trace Elem Res* 127(3):257-268.
- Kobayashi E, Suwazono Y, Honda R, et al. 2008b. Serial changes in urinary cadmium concentrations and degree of renal tubular injury after soil replacement in cadmium-polluted rice paddies. *Toxicol Lett* 176(2):124-130.
- *Kobayashi E, Suwazono Y, Uetani M, et al. 2005. Association between lifetime cadmium intake and cadmium concentration in individual urine. *Bull Environ Contam Toxicol* 74(5):817-821.
- Kobayashi E, Suwazono Y, Uetani M, et al. 2006. Estimation of benchmark dose as the threshold levels of urinary cadmium, based on excretion of total protein, β_2 -microglobulin and *N*-acetyl- β -D-glucosaminidase in cadmium nonpolluted regions in Japan. *Environ Res* 101(3):401-406.
- Koizumi N, Ohashi F, Ikeda M. 2010. Lack of correlation between cadmium level in local brown rice and renal failure mortality among the residents: A nation-wide analysis in Japan. *Int Arch Occup Environ Health* 83(3):333-339.
- Komárek J, Slaninova M, Vrestal, et al. 1991. Determination of cadmium by electrothermal atomic absorption spectrometry. *Collect Czech Chem Commun* 56:2083-2095.
- Komori M, Nishio K, Kitada M, et al. 1990. Fetus-specific expression of a form of cytochrome P-450 in human livers. *Biochemistry* 29(18):4430-4433.
- Konig HP, Heinrich U, Kock H, et al. 1992. Effect of photocorrosion on cadmium sulfide suspensions applied in animal inhalation studies with CDS particles. *Arch Environ Contam Toxicol* 22:30-35.
- Kopp SJ, Glonek T, Perry HM, et al. 1982. Cardiovascular actions of cadmium at environmental exposure levels. *Science* 217:837-839.

9. REFERENCES

- *Kostial K, Blanusa M, Maljkovic T, et al. 1989. Effect of a metal mixture in diet on the toxicokinetics and toxicity of cadmium, mercury and manganese in rats. *Toxicol Ind Health* 5:686-698.
- Kostial K, Blanusa M, Schonwald N, et al. 1993. Organ cadmium deposits in orally exposed female rats and their pups and the depleting efficiency of sodium N-4-(methoxybenzyl)-d-glucamine-N-carbodithioate monohydrate (MeOBDCG). *Appl Toxicol* 13(3):203-207.
- Kostial K, Kello D, Jugo S, et al. 1978. Influence of age on metal metabolism and toxicity. *Environ Health Perspect* 25:81-86.
- Kostial K, Piasek M, Blanusa M, et al. 1996. Combined treatment with a new bis-carbodithioate C9G2DTC for mobilizing cadmium deposits in rats. *J Appl Toxicol* 16(2):157-158.
- Kotsonis FN, Klaassen CD. 1977. Toxicity and distribution of cadmium administered to rats at sublethal doses. *Toxicol Appl Pharmacol* 41:667-680.
- Kotsonis FN, Klaassen CD. 1978. The relationship of metallothionein to the toxicity of cadmium after prolonged administration to rats. *Toxicol Appl Pharmacol* 46:39-54.
- *Kowal NE. 1988. Urinary cadmium and B₂-microglobulin: Correlation with nutrition and smoking history. *J Toxicol Environ Health* 25:179-183.
- Kozłowska D, Brzozowska A, Sulkowska J, et al. 1993. The effect of cadmium on iron metabolism in rats. *Nutr Res* 13:1163-1172.
- *Kreis IA, de Does M, Hoekstra JA, et al. 1993. Effects of cadmium on reproduction, an epizootologic study. *Teratology* 48(3):189-196.
- Krishnan K, Andersen ME. 1994. Physiologically based pharmacokinetic modeling in toxicology. In: Hayes AW, ed. *Principles and methods of toxicology*. 3rd ed. New York, NY: Raven Press, Ltd., 149-188.
- Krishnan K, Andersen ME, Clewell HJ, et al. 1994. Physiologically based pharmacokinetic modeling of chemical mixtures. In: Yang RSH, ed. *Toxicology of chemical mixtures: Case studies, mechanisms, and novel approaches*. San Diego, CA: Academic Press, 399-437.
- *Krishnan SS, Harrison JE, Jervis RE, et al. 1988. Studies of skeletal cadmium assay and toxicity. *J Radioanal Nucl Chem* 124:79-84.
- Krzystyniak K, Fournier M, Trottier B, et al. 1987. Immunosuppression in mice after inhalation of cadmium aerosol. *Toxicol Lett* 38:1-12.
- *Kucharz EJ. 1988. Effect of cadmium intoxication on collagen and elastin content in tissues of the rat. *Bull Environ Contam Toxicol* 40:273-279.
- *Kudo N, Nakagawa Y, Waku K. 1990. The effect of cadmium on the composition and metabolism of hepatic fatty acids in zinc-adequate and zinc-deficient rats. *Toxicol Lett* 50:203-212.
- Kuhnert PM, Kihnert BR, Bottoms SF, et al. 1982. Cadmium levels in maternal blood, fetal cord blood, and placental tissues of pregnant women who smoke. *Am J Obstet Gynecol* 142:1021-1025.

9. REFERENCES

- Kurokawa Y, Takahashi M, Maekawa A, et al. 1989. Promoting effect of metal compounds on liver, stomach, kidney, pancreas, and skin carcinogenesis. *Am Coll Toxicol* 8:1235-1239.
- Kuroshima R. 1992. Cadmium accumulation in the mummichog, *Fundulus heteroclitus*, adapted to various salinities. *Bull Environ Contam Toxicol* 49(5):680-685.
- Kutzman RS, Drew RT, Shiotsuka RN, et al. 1986. Pulmonary changes resulting from subchronic exposure to cadmium chloride aerosol. *J Toxicol Environ Health* 17:175-189.
- Lagerkvist BJ, Lundstrom NG. 2004. Lead-and cadmium levels in children living close to a copper and lead smelter in Sweden. *Biometals* 17(5):593-594.
- *Lagerkvist BJ, Nordberg GF, Soderberg HA, et al. 1992. Placental transfer of cadmium. In: Nordberg GF, Herber RFM, Alessio L, eds. *Cadmium in the human environment: Toxicity and carcinogenicity*. IARC Scientific Publications No. 118. Lyon, France: International Agency for Research on Cancer, 287-291.
- *Lagerkvist BJ, Soderberg H-A, Nordberg GF, et al. 1993. Biological monitoring of arsenic, lead and cadmium in occupationally and environmentally exposed pregnant women. *Scand J Work Environ Health* 19(Suppl. 1):50-53.
- *Lai YL, Diamond L. 1992. Cigarette smoke exposure does not prevent cadmium-induced alterations in rat lungs. *J Toxicol Environ Health* 35(1):63-76.
- Lamm SH, Hall TA, Kutcher JS. 1994. Particulate exposure among cadmium workers: Is the risk due to cigarette, cadmium or arsenic particulates? *Ann Occup Hyg* 38:873-878.
- Lamm SH, Parkinson M, Anderson M, et al. 1992. Determinants of lung cancer risk among cadmium-exposed workers. *Ann Epidemiol* 2:195-211.
- Landsberger S, Wu D. 1993. Improvement of analytical sensitivities for the determination of antimony, arsenic, cadmium, indium, iodine molybdenum, silicon and uranium in airborne particulate matter by epithermal neutron activation analysis. *J Radioanal Nucl Chem* 167(2):219-225.
- Lane RE, Campbell AC. 1954. Fatal emphysema in two men making a copper cadmium alloy. *Br J Ind Med* 11:118-122.
- Larregle EV, Varas SM, Oliveros LB, et al. 2008. Lipid metabolism in liver of rat exposed to cadmium. *Food Chem Toxicol* 46(5):1786-1792.
- Larsson SE, Piscator M. 1971. Effect of cadmium on skeletal tissue in normal and cadmium-deficient rats. *Isr J Med Sci* 7:495-498.
- *Laskey JW, Rehnberg GL, Favor MJ, et al. 1980. Chronic ingestion of cadmium and/or tritium. II. Effects on growth, development, and reproductive function. *Environ Res* 22:466-475.
- *Laskey JW, Rehnberg GL, Laws SC, et al. 1984. Reproductive effects of low acute doses of cadmium chloride in adult male rats. *Toxicol Appl Pharmacol* 73:250-255.

9. REFERENCES

- Lauwerys R, De Wals PH. 1981. Environmental pollution by cadmium and mortality from renal diseases. *Lancet* 1(8216):383.
- Lauwerys R, Bernard A, Buchet JP, et al. 1991. Does environmental exposure to cadmium represent a health risk? Conclusions from the Cadmibel study. *Acta Clin Belg* 46(44):219-225.
- Lauwerys R, Buchet JP, Roels H, et al. 1978. Placental transfer of lead, mercury, cadmium, and carbon monoxide in women. I. Comparison of the frequency distributions of the biological indices in maternal and umbilical cord blood. *Environ Res* 15:278-289.
- Lauwerys R, Hardey R, Job M, et al. 1984. Environmental pollution by cadmium and cadmium body burden: An autopsy study. *Toxicol Lett* 23:287-289.
- Lauwerys RR, Bernard AM, Roels HA, et al. 1994. Cadmium: Exposure markers as predictors of nephrotoxic effects. *Clin Chem* 40(7):1391-1394.
- Lazebnik N, Kuhnert BR, Kihnert PM. 1989. Zinc, cadmium, and hypertension in parturient women. *Am J Obstet Gynecol* 161:437-440.
- Leduc D, de Francquen P, Jacobovitz D, et al. 1993. Association of cadmium exposure with rapidly progressive emphysema in a smoker. *Thorax* 48:570-571.
- Lee, MS; Park, SK; Hu, H; et al. 2011. Cadmium exposure and cardiovascular disease in the 2005 Korea National Health and Nutrition Examination Survey. *Environ Res* 111(1):171-176.
- Leeder JS, Kearns GL. 1997. Pharmacogenetics in pediatrics: Implications for practice. *Pediatr Clin North Am* 44(1):55-77.
- Lehman LD, Klaassen CD. 1986. Dosage-dependent disposition of cadmium administered orally to rats. *Toxicol Appl Pharmacol* 84:159-167.
- *Lehotzky K, Ungvary G, Polinak D, et al. 1990. Behavioral deficits due to prenatal exposure to cadmium chloride in CFY rat pups. *Neurotoxicol Teratol* 12:169-172.
- Leikin JB, Paloucek FP. 2002. Cadmium. In: *Poisoning and toxicology handbook*. Hudson, OH: Lexi-Comp, Inc., 309-310.
- Lemen RA, Lee JS, Wagoner JK, et al. 1976. Cancer mortality among cadmium production workers. *Ann N Y Acad Sci* 271:273-279.
- Leroyer A, Hemon D, Nisse C, et al. 2001. Determinants of cadmium burden levels in a population of children living in the vicinity of nonferrous smelters. *Environ Res* 87(3):147-159.
- Leung HW. 1993. Physiologically-based pharmacokinetic modelling. In: Ballentyne B, Marrs T, Turner P, eds. *General and applied toxicology*. Vol. 1. New York, NY: Stockton Press, 153-164.
- Levy LS, Clack J. 1975. Further studies on the effect of cadmium on the prostate gland. I. Absence of prostatic changes in rats given oral cadmium sulfate for two years. *Ann Occup Hyg* 17:205-211.

9. REFERENCES

- Levy LS, Clack J, Roe FJ. 1975. Further studies on the effect of cadmium on the prostate gland. II. Absence of prostatic changes in mice given oral cadmium sulfate for eighteen months. *Ann Occup Hyg* 17:213-220.
- Lewis GP, Coughlin L, Jusko W, et al. 1972a. Contribution of cigarette smoking to cadmium accumulation in man. *Lancet* 1:291-292.
- Lewis GP, Jusko WJ, Coughlin LL. 1972b. Cadmium accumulation in man: Influence of smoking, occupation, alcoholic habit and disease. *J Chronic Dis* 25:717-726.
- Lewis RJ, ed. 2000. In: Sax's dangerous properties of industrial materials. Vol. 2. 10th ed. New York, NY: John Wiley & Sons, Inc., 667, 669, 673.
- Lewis RJ, ed. 2001. In: Cadmium and cadmium compounds. Hawley's condensed chemical dictionary. 14th ed. New York, NY: John Wiley & Sons, Inc., 186-188.
- Lide DR, ed. 2005. CRC handbook of chemistry and physics. 86th ed. Boca Raton, FL: Taylor & Francis, 4-53, 4-54.
- Lieberman KW, Kramer HH. 1970. Cadmium determination in biological tissue by neutron activation analysis. *Anal Chem* 42:266-267.
- Lind Y, Wicklund Glynn A, Engman J, et al. 1995. Bioavailability of cadmium from crab hepatopancreas and mushroom in relation to inorganic cadmium: A 9-week feeding study in mice. *Food Chem Toxicol* 33(8):667-673.
- Lindqvist B, Nystrom K, Stegmayr B, et al. 1989. Cadmium concentration in human kidney biopsies. *Scand J Urol Nephrol* 23:213-217.
- Liu J, Klaassen CD. 1996. Absorption and distribution of cadmium in metallothionein-I transgenic mice. *Fundam Appl Toxicol* 29:294-300.
- Liu J, Liu Y, Habecbu SS, et al. 1998. Susceptibility of MT-null mice to chronic CdCl₂-induced nephrotoxicity indicates that renal injury is not mediated by the CdMT complex. *Toxicol Sci* 46(1):197-203.
- Liu J, Liu Y, Michalska AE, et al. 1996. Distribution and retention of cadmium in metallothionein I and II null mice. *Toxicol Appl Pharmacol* 136(2):260-268.
- Liu YZ, Huang JX, Luo CM, et al. 1985. Effects of cadmium on cadmium smelter workers. *Scand J Work Environ Health* 11(Suppl 4):29-32.
- Livingston AL. 1978. Forage plant estrogens. *J Toxicol Environ Health* 4(2-3):301-324.
- Loeser E, Lorke D. 1977a. Semichronic oral toxicity of cadmium. I. Studies on rats. *Toxicology* 7:215-224.
- Loeser E, Lorke D. 1977b. Semichronic oral toxicity of cadmium. II. Studies on dogs. *Toxicology* 7:225-232.

9. REFERENCES

- Lopez-Ortal P, Souza V, Bucio L, et al. 1999. DNA damage produced by cadmium in a human fetal hepatic cell line. *Mutat Res* 439(2):301-306.
- Löser E. 1980. A two year oral carcinogenicity study with cadmium on rats. *Cancer Lett* 9(3):191-198.
- Lu J, Jin T, Nordberg G, et al. 2001. Metallothionein gene expression in peripheral lymphocytes from cadmium-exposed workers. *Cell Stress Chaperones* 6(2):97-104.
- Lucas PA, Jariwalla AG, Jones JH, et al. 1980. Fatal cadmium fume inhalation. *Lancet* 2(8187):205.
- Lutzen A, Liberti SE, Rasmussen LJ. 2004. Cadmium inhibits human DNA mismatch repair *in vivo*. *Biochem Biophys Res Commun* 321(1):21-25.
- Lynn S, Lai HT, Kao SM, et al. 1997. Cadmium inhibits DNA strand break rejoining in methyl methanesulfonate-treated CHO-K1 cells. *Toxicol Appl Pharmacol* 144(1):171-176.
- Ma R, Van Mol W, Adams F. 1994a. Determination of cadmium, copper and lead in environmental samples. An evaluation of flow injection on-line sorbent extraction for flame atomic absorption spectrometry. *Anal Chim Acta* 285:33-43.
- Ma R, Van Mol W, Adams F. 1994b. Selective flow injection sorbent extraction for determination of cadmium, copper and lead in biological and environmental samples by graphite furnace absorption spectrometry. *Anal Chim Acta* 293:251-260.
- Machemer L, Lorke D. 1981. Embryotoxic effect of cadmium on rats upon oral administration. *Toxicol Appl Pharmacol* 58:438-443.
- Mailhes JB, Preston RJ, Yuan ZP, et al. 1988. Analysis of mouse metaphase II oocytes as an assay for chemically induced aneuploidy. *Mutat Res* 198:145-152.
- *Maitani T, Cuppage FE, Flaassen CD. 1988. Nephrotoxicity of intravenously injected cadmium-metallothionein: Critical concentration and tolerance. *Fundam Appl Toxicol* 10:98-108.
- Maitani T, Waalkes MP, Klaassen CD. 1984. Distribution of cadmium after oral administration of cadmium-thionein to mice. *Toxicol Appl Pharmacol* 74:237-243.
- Malave I, de Ruffino DT. 1984. Altered immune response during cadmium administration in mice. *Toxicol Appl Pharmacol* 74:46-56.
- *Manca D, Ricard AC, Tra HV et al. 1994. Relation between lipid peroxidation and inflammation in the pulmonary toxicity of cadmium. *Arch Toxicol* 68(6):364-369.
- Mandel R, Ryser HJP. 1984. Mutagenicity of cadmium in *Salmonella typhimurium* and its synergism with two nitrosamines. *Mutat Res* 138:9-16.
- Mangler B, Fischer G, Classen HG, et al. 1988. The induction and reversibility of cadmium-induced nephropathy in rats: Quantitative analytical and histopathological studies. *Trace Elem Med* 5:143-149.
- Mann SJ. 1973. Whole body retention and tissue distribution of intravenously administered ^{115m}Cd in goats, sheep, and dogs. M.S. Thesis, Purdue University.

9. REFERENCES

- Maravelias C, Hatzakis A, Katsouyanni, et al. 1989. Exposure to lead and cadmium of children living near a lead smelter at Lavrion, Greece. *Sci Total Environ* 84:61-70.
- Marlowe M, Cossairt A, Moon C, et al. 1985. Main and interaction effects of metallic toxins on classroom behavior. *J Abnorm Child Psychol* 13:185-198.
- Martin FM, Witschi HP. 1985. Cadmium-induced lung injury: Cell kinetics and long-term effects. *Toxicol Appl Pharmacol* 80:215-227.
- Masaoka T, Akahori F, Arai S, et al. 1994. A nine-year chronic toxicity study of cadmium ingestion in monkeys. I. Effects of dietary cadmium on the general health of monkeys. *Vet Hum Toxicol* 36(3):189-194.
- Mason HJ. 1990. Occupational cadmium exposure and testicular endocrine function. *Hum Exp Toxicol* 9:91-94.
- Mason HJ, Davison AG, Wright AL, et al. 1988. Relations between liver cadmium, cumulative exposure, and renal function in cadmium alloy workers. *Br J Ind Med* 45:793-802.
- Mason HJ, Stevenson AJ, Williams N, et al. 1999. Intra-individual variability in markers of proteinuria for normal subjects and those with cadmium-induced renal dysfunction: Interpretation of results from untimed, random urine samples. *Biomarkers* 4(2):118-128.
- Mason HJ, Williams N, Armitage S, et al. 1999. Follow up of workers previously exposed to silver solder containing cadmium. *Occup Environ Med* 56(8):553-558.
- Mason RP, Laporte JM, Andres S. 2000. Factors controlling the bioaccumulation of mercury, methylmercury, arsenic, selenium, and cadmium by freshwater invertebrates and fish. *Arch Environ Contam Toxicol* 38:283-297.
- Mathews TD. 1994. Contaminants in recreationally important estuarine finfish from South Carolina. *Bull Environ Contam Toxicol* 53:412-419.
- Matsubara-Khan J. 1974. Compartmental analysis for the evaluation of biological half lives of cadmium and mercury in mouse organs. *Environ Res* 7:54-67.
- Matsuda T, Kobayashi E, Okubo Y, et al. 2002. Association between renal dysfunction and mortality among inhabitants in the region around the Jinzu River Basin polluted by cadmium. *Environ Res* 88:156-163.
- Mayr U, Butsch A, Schneider S. 1992. Validation of two *in vitro* test systems for estrogenic activities with zearalenone, phytoestrogens and cereal extracts. *Toxicology* 74(2-3):135-149.
- McBride MB. 1995. Toxic metal accumulation from agricultural use of sludge: Are USEPA regulations protective? *J Environ Qual* 24:5-18.
- McComish MF, Ong JH. 1988. Cadmium. In: Bodek I, Lyman WJ, Reehl WF, et al., eds. *Environmental inorganic chemistry: Properties, processes, and estimation methods*. New York, NY: Pergamon Press, 7.5-1 to 7.5-12.

9. REFERENCES

- McDiarmid MA, Freeman CS, Grossman EA, et al. 1997. Follow-up of biologic monitoring results in cadmium workers removed from exposure. *Am J Ind Med* 32:261-267.
- McKelvey W, Gwynn RC, Jeffery N, et al. 2007. A biomonitoring study of lead, cadmium, and mercury in the blood of New York City adults. *Environ Health Perspect* 115(10):1435-1441.
- McKenzie-Parnell JM, Kjellström TE, Sharma RP, et al. 1988. Unusually high intake and fecal output of cadmium, and fecal output of other trace elements in New Zealand adults consuming dredge oysters. *Environ Res* 46:1-14.
- McLellan JS, Flanagan PR, Chamberlain MJ, et al. 1978. Measurement of dietary cadmium absorption in humans. *J Toxicol Environ Health* 4:131-138.
- Meltzer HM, Brantsaeter AL, Borch-Johnsen B, et al. 2010. Low iron stores are related to higher blood concentrations of manganese, cobalt and cadmium in non-smoking, Norwegian women in the HUNT 2 study. *Environ Res* 110(5):497-504.
- Menke A, Guallar E, Shiels MS, et al. 2008. The association of urinary cadmium with sex steroid hormone concentrations in a general population sample of U.S. adult men. *BMC Publ Health* 8:72-79.
- Menke, A; Muntner, P; Silbergeld, EK; et al. 2009. Cadmium levels in urine and mortality among U.S. adults. *Environ Health Perspect* 117(2):190-196.
- Mielke HW, Adams JL, Chaney RL, et al. 1991. The pattern of cadmium in the environment of five Minnesota cities. *Environ Geochem Health* 13:29-34.
- Migliore L, Cocchi L, Nesti C, et al. 1999. Micronuclei assay and FISH analysis in human lymphocytes treated with six metal salts. *Environ Mol Mutagen* 34(4):279-284.
- Mikhailova MV, Littlefield NA, Hass BS, et al. 1997. Cadmium-induced δ -hydroxydeoxyguanosine formation, DNA strand breaks and antioxidant enzyme activities in lymphoblastoid cells. *Cancer Lett* 115:141-148.
- Miller ML, Murthy L, Basom CR, et al. 1974a. Alteration in hepatocytes after manipulation of the diet: Copper, zinc and cadmium interactions. *Am J Anat* 141:23-40.
- Miller ML, Murthy L, Sorenson JR. 1974b. Fine structure of connective tissue after ingestion of cadmium: Observations on interstitium on male rat lung. *Arch Pathol* 98:386-392.
- Miller WJ, Blackmon DM, Gentry RP, et al. 1969. Effect of dietary cadmium on tissue distribution of ¹⁰⁹cadmium following a single oral dose in young goats. *J Dairy Sci* 32(12):2029-2033.
- Milvy P, Kay K. 1978. Mutagenicity of 19 major graphic arts and printing dyes. *J Toxicol Environ Health* 4:41-36.
- Min KS, Ueda H, Tanaka K. 2008. Involvement of intestinal calcium transporter 1 and metallothionein in cadmium accumulation in the liver and kidney of mice fed a low-calcium diet. *Toxicol Lett* 176:85-92.
- Misra RR, Smith GT, Waalkes MP. 1998. Evaluation of the direct genotoxic potential of cadmium in four different rodent cell lines. *Toxicology* 126:103-114.

9. REFERENCES

- Mokhtar G, Hossny E, el-Awady M, et al. 2002. *In utero* exposure to cadmium pollution in Cairo and Giza governorates of Egypt. *East Mediter Health J* 8(2-3):254-260.
- Monzawa K, Kido T, Yamaya H, et al. 1998. Urinary excretion levels of sodium and potassium in environmental cadmium-exposed subjects. *Toxicology* 127:187-193.
- Moore W, Stara JF, Crocker WC, et al. 1973. Comparison of ¹¹⁵Cd retention in rats following different routes of administration. *Environ Res* 6:473-478.
- Morgan H, Sherlock JC. 1984. Cadmium intake and cadmium in the human kidney. *Food Addit Contam* 1:45-51.
- Morgan H, Simms DI. 1988. The Shipham Report: Discussion and conclusions. *Sci Total Environ* 75:135-143.
- Moriguchi J, Ezaki T, Tsukahara T, et al. 2005a. α_1 -Microglobulin levels and correlation with cadmium and other metals in urine of non-smoking women among general populations in Japan. *Toxicol Environ Chem* 87(1):119-133.
- Moriguchi J, Ezaki T, Tsukahara T, et al. 2005b. Decreases in urine specific gravity and urinary creatinine in elderly women. *Int Arch Occup Environ Health* 78:438-445.
- Morrow H. 2001. Cadmium and cadmium alloys. In: Kirk-Othmer encyclopedia of chemical technology. John Wiley & Sons, Inc., 471-507.
<http://www.mrw.interscience.wiley.com/emrw/9780471238966/kirk/article/cadmcar.a01/current/pdf?hd=All%2Ccadmium>. April 29, 2008.
- Morrow H. 2010. Cadmium and cadmium alloys. In: Kirk-Othmer encyclopedia of chemical technology. John Wiley & Sons, Inc.
<http://onlinelibrary.wiley.com/doi/10.1002/0471238961.0301041303011818.a01.pub3/abstract>. September 10, 2012.
- Morselli PL, Franco-Morselli R, Bossi L. 1980. Clinical pharmacokinetics in newborns and infants: Age-related differences and therapeutic implications. *Clin Pharmacokin* 5(6):485-527.
- *Mueller PW, Paschal DC, Hammel RR, et al. 1992. Chronic renal effects in three studies of men and women occupationally exposed to cadmium. *Arch Environ Contam Toxicol* 23:125-136.
- Mueller PW, Smith SJ, Steinberg KK, et al. 1989. Chronic renal tubular effects in relation to urine cadmium levels. *Nephron* 52:45-54.
- Mukherjee A, Giri AK, Sharma A, et al. 1988a. Relative efficacy of short-term tests in detecting genotoxic effects of cadmium chloride in mice *in vivo*. *Mutat Res* 206:285-295.
- Mukherjee A, Sharma A, Talukder G. 1988b. Effect of selenium on cadmium-induced chromosomal aberrations in bone marrow cells of mice. *Toxicol Lett* 41:23-29.
- *Muller L, Stacey NH. 1988. Subcellular toxicity of low level cadmium in rats: Effect on cytochrome C oxidase. *Toxicology* 51:25-34.

9. REFERENCES

- Muller L, Abel J, Ohnesorge FK. 1986. Absorption and distribution of cadmium (Cd), copper and zinc following oral subchronic low level administration to rats of different binding forms of cadmium (Cd-acetate, Cd-metallothionein, Cd-glutathione). *Toxicology* 39:187-195.
- Muller L, Craig G, Stacey NH. 1988. Dose response of rat liver to low level cadmium. *Bull Environ Contam Toxicol* 40:301-308.
- Munshower FF. 1977. Cadmium accumulation in plants and animals of polluted and nonpolluted grasslands. *J Environ Qual* 6:411-413.
- Muntau H, Baudo R. 1992. Sources of cadmium, its distribution and turnover in the freshwater environment. *IARC Sci Publ* 118:133-148.
- Murthy RC, Saxena DK, Lal B, et al. 1989. Chronic cadmium-ethanol administration alters metal distribution and some biochemicals in rat brain. *Biochem Int* 19:135-143.
- Muys T. 1984. Quantitative determination of lead and cadmium in foods by programmed dry ashing and atomic absorption spectrophotometry with electrothermal atomization. *Analyst* 109:119-121.
- Nagaraj M, Sunitha S, Varalakshmi P. 2000. Effect of lupeol, a pentacyclic triterpene, on the lipid peroxidation and antioxidant status in rat kidney after chronic cadmium exposure. *J Appl Toxicol* 20(5):413-417.
- Nagymajtenyi L, Schulz H, Desi I. 1997. Behavioural and functional neurotoxicological changes caused by cadmium in a three-generational study in rats. *Hum Exp Toxicol* 16(12):691-699.
- *Nagyova A, Galbavy S, Ginter E. 1994b. Histopathological evidence of vitamin C protection against Cd-nephrotoxicity in guinea pigs. *Exp Toxicol Pathol* 46(1):11-14.
- *Nagyova A, Ginter E, Stefek M. 1994a. Effect of cadmium on hepatic microsomal monooxygenase activities in guinea pigs with low and high ascorbic acid intake. *J Nutr Biochem* 5(1):10-14.
- Nakada T, Furuta H, Koike H, et al. 1989. Impaired urine concentrating ability in Itai-itai Ouch-ouch disease. *Int Urol Nephrol* 21:201-210.
- Nakadaira H, Nishi S. 2003. Effects of low-dose cadmium exposure on biological examinations. *Sci Total Environ* 308(1-3):49-62.
- Nakagawa H, Nishiojo M, Morikawa Y, et al. 1993. Urinary β_2 -microglobulin concentration and mortality in a cadmium-polluted area. *Arch Environ Health* 48:428-435.
- Nakagawa H, Sawano S, Okumura Y, et al. 1987. Mortality study of inhabitants in a cadmium-polluted area. *Bull Environ Contam Toxicol* 38:553-560.
- Nakashima K, Kobayashi E, Nogawa K, et al. 1997. Concentration of cadmium in rice and urinary indicators of renal dysfunction. *Occup Environ Med* 54:750-755.
- Nam DQ, Skacel F, Buryan P. 1994. Determination of airborne lead and cadmium collected on glass fibre filters by differential-pulse anodic stripping voltammetry. *Sci Total Environ* 144:87-92.

9. REFERENCES

- Naqvi SM, Howell RD. 1993. Cadmium and lead uptake by red swamp crayfish (*Procambarus clarkii*) of Louisiana. *Bull Environ Contam Toxicol* 51(2):296-302.
- Naruse I, Hayashi Y. 1989. Amelioration of the teratogenicity of cadmium by the metallothionein induced by bismuth nitrate. *Teratology* 40:459-465.
- NAS/NRC. 1989. Report of the oversight committee. In: *Biologic markers in reproductive toxicology*. Washington, DC: National Academy of Sciences, National Research Council, National Academy Press, 15-35.
- Nation JR, Bourgeois AE, Clark DE, et al. 1984. The effects of oral cadmium exposure on passive avoidance performance in the adult rat. *Toxicol Lett* 20:41-47.
- Nation JR, Grover CA, Bratton GR, et al. 1990. Behavioral antagonism between lead and cadmium. *Neurotoxicol Teratol* 12:99-104.
- Nation JR, Pugh CK, Von Stutz J, et al. 1989. The effects of cadmium on the self-administration of ethanol and an isocaloric/isohedonic equivalent. *Neurotoxicol Teratol* 11:509-514.
- Navas-Acien A, Silbergeld EK, Sharrett AR, et al. 2005. Metals in urine and peripheral arterial disease. *Environ Health Perspect* 113(2):164-169.
- Nayak BN, Ray M, Persaud TV, et al. 1989. Embryotoxicity and *in vivo* cytogenetic changes following maternal exposure to cadmium chloride in mice. *Exp Pathol* 36:75-80.
- Newton D, Johnson P, Lally AE, et al. 1984. The uptake by man of cadmium ingested in crab meat. *Hum Toxicol* 3:23-28.
- Nilsson U, Skerfving S. 1993. *In vivo* X-ray fluorescence measurements of cadmium and lead. *Scand J Work Environ Health* 19(Suppl 1):54-58.
- Nimmo M, Fones G. 1994. Application of adsorptive cathodic stripping voltammetry for the determination of Cu, Cd, Ni and Co in atmospheric samples. *Anal Chim Acta* 291:321-328.
- NIOSH. 1989. Numbers of potentially exposed employees. Washington, DC: U.S. Department of Health and Human Services, National Institute for Occupational Safety and Health.
- NIOSH. 1990. Numbers of potentially exposed employees. National Occupational Exposure Survey. U.S. Department of Health and Human Services, National Institute for Occupational Safety and Health. <http://www.cdc.gov/noes/>. July 8, 2008.
- *NIOSH. 1992a. NIOSH manual of analytical methods. Recommended exposure level. Washington, DC: U.S. Department of Health and Human Services, National Institute for Occupational Safety and Health.
- NIOSH. 1992b. NIOSH recommendations for occupational safety and health. Compendium of policy documents and statements. Categories of pesticides. Atlanta, GA: National Institute for Occupational Safety and Health, Centers for Disease Control and Prevention. <http://www.cdc.gov/niosh/92-100.html>. April 29, 2008.

9. REFERENCES

- NIOSH. 1994. Method 7048: Cadmium and compounds, as Cd. NIOSH Manual of Analytical Methods (NMAM). 4th ed. National Institute for Occupational Safety and Health. <http://www.cdc.gov/niosh/nmam/pdfs/7048.pdf>. May 13, 2008.
- NIOSH. 2003. Method 7300: Elements by ICP (nitric/perchloric acid ashing). National Institute for Occupational Safety and Health. <http://www.cdc.gov/niosh/nmam/pdfs/7300.PDF>. May 13, 2008.
- NIOSH. 2005. Cadmium. NIOSH pocket guide to chemical hazards. Atlanta, GA: National Institute for Occupational Safety and Health, Centers for Disease Control and Prevention. <http://www.cdc.gov/niosh/npg/> April 24, 2008.
- Nishijo M, Morikawa Y, Nakagawa H, et al. 2006. Causes of death and renal tubular dysfunction in residents exposed to cadmium in the environment. *Occup Environ Med* 63:545-550.
- Nishijo M, Nakagawa H, Honda R, et al. 2002. Effects of maternal exposure to cadmium on pregnancy outcome and breast milk. *Occup Environ Med* 59(6): 394-397.
- Nishijo M, Nakagawa H, Morikawa Y, et al. 2004a. Mortality in a cadmium polluted area Japan. *Biometals* 17(5):535-538.
- Nishijo M, Nakagawa H, Morikawa Y, et al. 1995. Mortality of inhabitants in an area polluted by cadmium: 15 year follow up. *Occup Environ Med* 52:181-184.
- Nishijo M, Satarug S, Honda R, et al. 2004b. The gender differences in health effects of environmental cadmium exposure and potential mechanisms. *Mol Cell Biochem* 255:87-92.
- Nishino H, Shiroishi K, Kagamimori S, et al. 1988. Studies on the increase in serum concentrations of urea cycle amino acids among subjects exposed to cadmium. *Bull Environ Contam Toxicol* 40:553-560.
- Nishioka H. 1975. Mutagenic activities of metal compounds in bacteria. *Mutat Res* 311:185-189.
- *Noack-Fuller G, DeBeer C, Seibert H. 1993. Cadmium, lead, selenium, and zinc in semen of occupationally unexposed men. *Andrologia* 25(1):7-12.
- *Nogawa K. 1984. Biological indicators of cadmium nephrotoxicity in persons with low-level cadmium exposure. *Environ Health Perspect* 54:163-169.
- Nogawa K, Honda R, Kido T, et al. 1989. A dose-response analysis of cadmium in the general environment with special reference to total cadmium intake limit. *Environ Res* 48:7-16.
- *Nogawa K, Kawano S, Nishi M. 1981a. Mortality study of inhabitants in a cadmium-polluted area with special reference to low-molecular-weight proteinuria. In: Ernst WH, ed. *Proceedings of the International Conference on Heavy Metals in the Environment*. Edinburgh: CEP Consultants, 538-540.
- Nogawa K, Kobayashi E, Honda R, et al. 1980. Renal dysfunction of inhabitants in a cadmium-polluted area. *Environ Res* 23:13-23.
- Nogawa K, Kobayashi E, Konishi F. 1981b. Comparison of bone lesions in chronic cadmium intoxication and vitamin D deficiency. *Environ Res* 23:233-249.

9. REFERENCES

- Nogawa K, Tsuritani I, Kido T, et al. 1987. Mechanism for bone disease found in inhabitants environmentally exposed to cadmium: Decreased serum 1-alpha, 25-dihydroxy vitamin D level. *Int Arch Occup Environ Health* 59:21-30.
- Nogawa K, Tsuritani I, Kido T, et al. 1990. Serum vitamin D metabolites in cadmium-exposed persons with renal damage. *Int Arch Occup Environ Health* 62:189-193.
- Nomiyama K, Nomiyama H. 1986. Critical concentrations of 'unbound' cadmium in the rabbit renal cortex. *Experientia* 42:149.
- Nomiyama K, Sugata Y, Yamamoto A, et al. 1975. Effects of dietary cadmium on rabbits. I. Early signs of cadmium intoxication. *Toxicol Appl Pharmacol* 31:4-12.
- Noonan CW, Sarasua SM, Campagna D, et al. 2002. Effects of exposure to low levels of environmental cadmium on renal biomarkers. *Environ Health Perspect* 110(2):151-155.
- Nordberg GF. 2010. Biomarkers of exposure, effects and susceptibility in humans and their application in studies of interactions among metals in China. *Toxicol Lett* 192(1):45-49.
- Nordberg G, Jin T, Bernard A, et al. 2002. Low bone density and renal dysfunction following environmental cadmium exposure in China. *Ambio* 31(6):478-481.
- Nordberg GF, Kjellström T. 1979. Metabolic model for cadmium in man. *Environ Health Perspect* 28:211-217.
- Nordberg GF, Jin T, Kong Q, et al. 1997. Biological monitoring of cadmium exposure and renal effects in a population group residing in a polluted area in China. *Sci Total Environ* 199:111-114.
- Nordberg GF, Kjellström T, Nordberg M. 1985. Kinetics and metabolism. In: Friberg L, Elinder CG, Kjellström T, et al. eds. *Cadmium and health: A toxicological and epidemiological appraisal*. Vol. I. Exposure, dose, and metabolism. Boca Raton, FL: CRC Press, 103-178.
- Nordberg M, Nuottaniemi I, Cherian MG, et al. 1986. Characterization studies on the cadmium-binding proteins from two species of New Zealand oysters. *Environ Health Perspect* 65:57-62.
- Nordberg G, Slorach S, Steinstrom T. 1973. [Cadmium poisoning caused by a cooled-soft-drink machine.] *Lakartidningen* 70:601-604. (Swedish)
- NRC. 1993. *Pesticides in the diets of infants and children*. Washington, DC: National Research Council. National Academy Press.
- NRC. 2002. *Biosolids applied to land: Advancing standards and practices*. Washington, DC: National Research Council. National Academy Press.
<http://water.epa.gov/scitech/wastetech/biosolids/upload/complete.pdf>. September 10, 2012.
- NTP. 1994. Cadmium and certain cadmium compounds. In: *Seventh annual report on carcinogens, summary 1994*. U.S. National Toxicology Program, U.S. Public Health Service, Department of Health and Human Services, 111-116.

9. REFERENCES

- NTP. 1995. NTP technical report on toxicity studies of cadmium oxide (CAS No. 1306-19-0) administered by inhalation to F344/N rats and B6C3F mice. Research Triangle Park, NC: National Toxicology Program. Toxicity report series number 39.
- NTP. 2005. Cadmium. Report on carcinogens. 11th ed. Research Triangle Park, NC: U.S. Department of Health and Human Services, Public Health Service, National Toxicology Program. <http://ntp-server.niehs.nih.gov/ntp/roc/toc11.html>. April 24, 2008.
- NTP. 2011. Report on carcinogens. Twelfth edition. National Toxicology Program. U.S. Department of Health and Human Services, Public Health. <http://ntp-server.niehs.nih.gov/ntp/roc/twelfth/roc12.pdf> February 22, 2012.
- Nwosu JU, Harding AK, Linder G. 1995. Cadmium and lead uptake by edible crops grown in a silt loam soil. *Bull Environ Contam Toxicol* 54:570-578.
- NYS Dept of Health. 2006. New York State heavy metals registry 2000 through 2005. http://www.health.state.ny.us/environmental/workplace/heavy_metals_registry/docs/report_2005.pdf. May 12, 2008.
- *Oberdoerster G, Baumert H-P, Hochrainer D. 1979. The clearance of cadmium aerosols after inhalation exposure. *Am Ind Hyg Assoc J* 40(6):443-450.
- Oberdörster G. 1992. Pulmonary deposition, clearance and effects of inhaled soluble and insoluble cadmium compounds. In: Nordberg GF, Herber RFM, Alessio L, eds. *Cadmium in the human environment: Toxicity and carcinogenicity*. Lyon: International Agency for Research on Cancer, 189-204.
- Oberdörster G, Cherian MG, Baggs RB. 1994. Importance of species differences in experimental pulmonary carcinogenicity of inhaled cadmium for extrapolation to humans. *Toxicol Lett* 72:339-343.
- Oberly TJ, Piper CE, McDonald DS. 1982. Mutagenicity of metal salts in the L5178Y mouse lymphoma assay. *J Toxicol Environ Health* 9:367-376.
- *O'Brien IG, King LJ. 1989. The effect of chronic parenteral administration of cadmium on isoenzyme levels of alkaline phosphatase in intestinal mucosa. *Toxicology* 56:87-94.
- OECD. 1995. Risk reduction monograph No. 5: Cadmium. Background and national experience with reducing risk. Paris, France: Organization for Economic Co-operation and Development. OCDE/GD(94)97.
- O'Flaherty EJ. 1993. Physiologically based models for bone-seeking elements. IV. Kinetics of lead disposition in humans. *Toxicol Appl Pharmacol* 118:16-29.
- Ogoshi K, Moriyama T, Nanzai Y. 1989. Decrease in the mechanical strength of bones of rats administered cadmium. *Arch Toxicol* 63:320-324.
- Ohba K, Okawa Y, Matsumoto Y, et al. 2007. A study of investigation of cadmium genotoxicity in rat bone cells using DNA microarray. *J Toxicol Sci* 32(1):107-109.
- Öhrvik H, Oskarsson A, Lundh T, et al. 2007. Impact of iron status on cadmium uptake in suckling piglets. *Toxicology* 240:15-24.

9. REFERENCES

- Ohsawa M, Takahashi K, Otsuka F. 1988. Induction of anti-nuclear antibodies in mice orally exposed to cadmium at low concentrations. *Clin Exp Immunol* 73:98-102.
- *Ohta H, DeAngelis MV, Cherian MG. 1989. Uptake of cadmium and metallothionein by rat everted intestinal sacs. *Toxicol Appl Pharmacol* 101:62-69.
- *Ohta H, Yamauchi Y, Nakakita M, et al. 2000. Relationship between renal dysfunction and bone metabolism disorder in male rats after long-term oral quantitative cadmium administration. *Ind Health* 38(4):339-355.
- *Oldereid NB, Thomassen Y, Attramadal A, et al. 1993. Concentrations of lead, cadmium and zinc in the tissues of reproductive organs of men. *J Reprod Fertil* 99:421-425.
- Oldiges H, Glaser U. 1986. The inhalative toxicity of different cadmium compounds in rats. *Trace Elem Med* 3:72-75.
- Oldiges H, Hochrainer D, Glaser U. 1989. Long-term inhalation study with Wistar rats and four cadmium compounds. *Toxicol Environ Chem* 19:217-222.
- Olsson IM, Bensryd I, Lundh T, et al. 2002. Cadmium in blood and urine—impact of sex, age, dietary intake, iron status, and former smoking—association of renal effects. *Environ Health Perspect* 110(12):1185-1190.
- Omaye ST, Tappel AL. 1975. Effect of cadmium chloride on the rat testicular-soluble selenoenzyme, glutathione peroxidase. *Res Commun Chem Pathol Pharmacol* 12:695-711.
- O'Neil MJ, Heckelman PE, Koch CB, et al. 2006. Cadmium and cadmium compounds. *Merck Index*. 14th ed. Whitehouse Station, NJ: Merck & Co., Inc, 263, 264.
- Oo YK, Kobayashi E, Nogawa K, et al. 2000. Renal effects of cadmium intake of a Japanese general population in two areas unpolluted by cadmium. *Arch Environ Health* 55(2):98-103.
- O'Riordan ML, Hughes EG, Evans HJ. 1978. Chromosomal studies on blood lymphocytes of men occupationally exposed to cadmium. *Mutat Res* 58:305-311.
- Orlowski C, Piotrowski JK, Subdys JK, et al. 1998. Urinary cadmium as indicator of renal cadmium in humans: An autopsy study. *Hum Exp Toxicol* 17(6):302-306.
- Ormos G, Cseh J, Groszmann M, et al. 1985. Urinary β_2 -microglobulin and retinol binding protein: Individual fluctuations in cadmium-exposed workers. *Toxicol Lett* 27:59-64.
- Ornes WH, Sajwan KS. 1993. Cadmium accumulation and bioavailability in coontail (*Ceratophyllum demersum* L.) plants. *Water Air Soil Pollut* 69:291-300.
- Osawa T, Kobayashi E, Okubo Y, et al. 2001. A retrospective study on the relation between renal dysfunction and cadmium concentration in rice in individual hamlets in the Jinzu River basin, Toyama Prefecture, Japan. *Environ Res* 86(Sect A):51-59.
- OSHA. 1990. Occupational exposure to cadmium; proposed rule. Occupational Safety and Health Administration. Code of Federal Regulations. 29 CFR 1910.

9. REFERENCES

- OSHA. 1991. ICP analysis of metal/metalloid particulates from solder operations. Occupational Safety and Health Administration. <http://www.osha.gov/dts/sltc/methods/inorganic/id206/id206.pdf>. May 14, 2008.
- OSHA. 2002a. Method ID-121: Metal and metalloid particulates in workplace atmospheres (atomic absorption). Occupational Safety and Health Administration. <http://www.osha.gov/dts/sltc/methods/inorganic/id121/id121.pdf>. May 14, 2008.
- OSHA. 2002b. Method ID-125G: Metal and metalloid particulates in workplace atmospheres (ICP analysis). Occupational Safety and Health Administration. <http://www.osha.gov/dts/sltc/methods/inorganic/id125g/id125g.html>. May 14, 2008.
- OSHA. 2004. Cadmium in workplace atmospheres. Occupational Safety and Health Administration. <http://www.osha.gov/dts/sltc/methods/inorganic/id189/id189.html>. August 18, 2008.
- OSHA. 2007a. Cadmium. Toxic and hazardous substances. Occupational Safety and Health Administration. Code of Federal Regulations. 29 CFR 1910.1027. <http://www.osha.gov/comp-links.html>. May 05, 2008.
- OSHA. 2007b. Cadmium. Toxic and hazardous substances. Occupational Safety and Health Administration. Code of Federal Regulations. 29 CFR 1915.1027. <http://www.osha.gov/comp-links.html>. May 05, 2008.
- OSHA. 2007c. Cadmium. Toxic and hazardous substances. Occupational Safety and Health Administration. Code of Federal Regulations. 29 CFR 1926.1127. <http://www.osha.gov/comp-links.html>. May 05, 2008.
- Ostapczuk P. 1993. Present potentials and limitations in the determination of trace elements by potentiometric stripping analysis. *Anal Chim Acta* 273:35-40.
- OTA. 1990. Neurotoxicity: Identifying and controlling poisons of the nervous system. Washington, DC: Office of Technology Assessment. OTABA438.
- Owen GM, Brozek J. 1966. Influence of age, sex and nutrition on body composition during childhood and adolescence. In: Falkner F, ed. *Human development*. Philadelphia, PA: WB Saunders, 222-238.
- Pacyna JM, Pacyna EG. 2001. An assessment of global and regional emissions of trace metals to the atmosphere from anthropogenic sources worldwide. *Environ Rev* 9(4):269-298.
- Pal R, Nath R, Gill KD. 1993a. Influence of ethanol on cadmium accumulation and its impact on lipid peroxidation and membrane bound functional enzymes (Na⁺, K⁺, -ATPase and acetylcholinesterase) in various regions of adult rat brain. *Neurochem Int* 23(5):451-458.
- Pal R, Nath R, Gill KD. 1993b. Lipid peroxidation and antioxidant defense enzymes in various regions of adult rat brain after co-exposure to cadmium and ethanol. *Pharmacol Toxicol* 73:209-214.
- Palus J, Rydzynski K, Dziubaltowska E, et al. 2003. Genotoxic effects of occupational exposure to lead and cadmium. *Mutat Res* 540(1):19-28.

9. REFERENCES

- Palmer KC, Mari F, Malian MS. 1986. Cadmium-induced acute lung injury: Compromised repair response following thyroidectomy. *Environ Res* 41:568-584.
- *Parizek J. 1964. Vascular changes at sites of oestrogen biosynthesis produced by parenteral injection of cadmium salts: The destruction of placenta by cadmium salts. *J Reprod Fertil* 7:263-265.
- Park JD, Cherrington NJ, Klaassen CD. 2002. Intestinal absorption of cadmium is associated with divalent metal transporter 1 in rats. *Toxicol Sci* 68(2):288-294.
- Paton GR, Allison AC. 1972. Chromosome damage in human cell culture induced by metal salts. *Mutat Res* 16:332-336.
- Patwardhan JR, Finckh ES. 1976. Fatal cadmium-fume pneumonitis. *Med J Aust* 1:962-966.
- Paulson A. 1997. The transport and fate of Fe, Mn, Cu, Zn, Cd, Pb and SO₄ in a groundwater plume and in downstream surface waters in the Coeur d'Alene mining district, Idaho, USA. *Appl Geochem* 12:447-464.
- Pellizzari ED, Perritt RL, Clayton CA. 1999. National human exposure assessment survey (NHEXAS): Exploratory survey of exposure among population subgroups in EPA Region V. *J Expo Anal Environ Epidemiol* 9:49-55
- Perry HM, Erlanger MW, Gustafsson TO, et al. 1989. Reversal of cadmium-induced hypertension by D-myo-inositol-1,2,6-trisphosphate. *J Toxicol Environ Health* 28:151-159.
- Petering HG, Choudhury H, Stemmer KL. 1979. Some effects of oral ingestion of cadmium on zinc, copper and iron metabolism. *Environ Health Perspect* 28:97-106.
- Peters JL, Perlstein TS, Perry MJ, et al. 2010. Cadmium exposure in association with history of stroke and heart failure. *Environ Res* 110(2):199-206.
- Peterson DP, Huff EA, Bhattacharyya MH. 1991. Determination of cadmium in blood, plasma, and urine by electrothermal atomic absorption spectrophotometry after isolation by anion-exchange chromatography. *Anal Biochem* 192(2):434-440.
- Petersson Grawé K, Oskarsson A. 2000. Cadmium in milk and mammary gland in rats and mice. *Arch Toxicol* 73(10-11):519-527.
- *Pharikal K, Das PC, Dey CD, et al. 1988. Tissue ascorbate as a metabolic marker in cadmium toxicity. *Int J Vitam Nutr Res* 58:306-311.
- Pierce FJ, Dowdy RH, Grigel DF. 1982. Concentrations of six trace metals in some major Minnesota Soil Series. *J Environ Qual* 11:416-422.
- Pirrone N, Keeler GJ, Nriagu JO, et al. 1996. Historical trends of airborne trace metals in Detroit from 1971 to 1992. *Water Air Soil Pollut* 88:145-165.
- Piscator M. 1966. Proteinuria in chronic poisoning. III. Electrophoretic and immunoelectrophoretic studies on urinary proteins from cadmium workers, with special reference to the excretion of low-molecular-weight proteins. *Arch Environ Health* 12:335-344.

9. REFERENCES

- Piscator M. 1972. Cadmium toxicity industrial and environmental experience. In: Proceedings 17th International Congress Occupational Health, Buenos Aires.
- Piscator M. 1984. Long-term observations on tubular and glomerula function in cadmium-exposed persons. *Environ Health Perspect* 54:175-179.
- Pleasant EW, Sandow ME, DeCandido S, et al. 1992. The effect of vitamin D3 and 1,25-dihydroxyvitamin D3 on the toxic symptoms of cadmium exposed rats. *Nutr Res* 12:1393-1403.
- Pleasant WE, Waslien C, Naughton BA, et al. 1993. Dietary modulation of the symptoms of cadmium toxicity in rats: Effects of vitamins A,C, D,DD hormone and fluoride. *Nutr Res* 13:839-850.
- Pless-Mulloli T, Boettcher M, Steiner M, et al. 1998. α -1-Microglobulin: epidemiological indicator for tubular dysfunction induced by cadmium? *Occup Environ Med* 55:440-445.
- Poirier LA, Kasprzak KS, Hoover KL, et al. 1983. Effects of calcium and magnesium acetates on the carcinogenicity of cadmium chloride in Wistar rats. *Cancer Res* 43:4575-4581.
- *Pond WG, Walker EF. 1972. Cadmium-induced anemia in growing rats: Prevention by oral or parenteral iron. *Nutr Rep Int* 5:365-370.
- Pond WG, Walker EF. 1975. Effect of dietary Ca and Cd level of pregnant rats on reproduction and on dam and progeny tissue mineral concentrations. *Proc Soc Exp Biol Med* 148:665-668.
- Potts AM, Simon FP, Tobias JM, et al. 1950. Distribution and fate of cadmium in the animal body. *Arch Ind Hyg* 2:175-188.
- Prigge E. 1978a. Early signs of oral and inhalative cadmium uptake in rats. *Arch Toxicol* 40:231-247.
- Prigge E. 1978b. Inhalative cadmium effects in pregnant and fetal rats. *Toxicology* 10:297-309.
- Prodan L. 1932. Cadmium poisoning: II. Experimental cadmium poisoning. *J Ind Hyg* 14:174-196.
- Putrament AH, Baranowska H, Ejchart A, et al. 1977. Manganese mutagenesis in yeast. VI. Mn^{2+} uptake, mitochondrial DNA replication and ER induction, comparison with other divalent cations. *Mol Gen Genet* 151:69-76.
- Racz P, Erdohelyi A. 1988. Cadmium, lead and copper concentrations in normal and senile cataractous human lenses. *Ophthalmic Res* 20:10-13.
- Radisch B, Luck W, Nau H. 1987. Cadmium concentrations in milk and blood of smoking mothers. *Toxicol Lett* 36:147-152.
- Ragan HA. 1977. Effects of iron deficiency on the absorption and distribution of lead and cadmium in rats. *J Lab Clin Med* 90(4):700-706.
- Rahola T, Aaran R-K, Miettinen JK. 1973. Retention and elimination of ^{115}mCd in man. In: Health physics problems of internal contamination. Budapest: Akademia 213-218.

9. REFERENCES

- *Rajanna B, Hobson M, Boykin M, et al. 1990. Effects of chronic treatment with cadmium on ATPases, uptake of catecholamines, and lipid peroxidation in rat brain synaptosomes. *Ecotoxicol Environ Saf* 20(1):36-41.
- Ramel C, Magnusson J. 1979. Chemical induction of nondisjunction in *Drosophila*. *Environ Health Perspect* 31:59-66.
- Reeves PG, Chaney RL. 2001. Mineral status of female rats affects the absorption and organ distribution of dietary cadmium derived from edible sunflower kernels (*Helianthus annuus* L.). *Environ Res* 85(3):215-225.
- Reeves PG, Chaney RL. 2002. Nutritional status affects the absorption and whole-body and organ retention of cadmium in rats fed rice-based diets. *Environ Sci Technol* 36:2684-2692.
- Reeves PG, Vanderpool RA. 1997. Cadmium burden of men and women who report regular consumption of confectionery sunflower kernels containing a natural abundance of cadmium. *Environ Health Perspect* 105(10):1098-104.
- *Rehm S, Waalkes MP. 1988. Cadmium-induced ovarian toxicity in hamsters, mice, and rats. *Fundam Appl Toxicol* 10:635-647.
- Reimann C, de Caritat P, Halleraker JH, et al. 1997. Regional atmospheric deposition patterns of Ag, As, Bi, Cd, Hg, Mo, Sb and Ti in a 188,000 km² area in the European Arctic as displayed by terrestrial moss samples-long-range atmospheric transport vs. local impact. *Atmos Environ* 31(23):3887-3901.
- Renugadevi J, Prabu SM. 2010. Cadmium-induced hepatotoxicity in rats and the protective effect of naringenin. *Exp Toxicol Pathol* 62(2):171-181.
- Roberts CA, Clark JM. 1986. Improved determination of cadmium in blood and plasma by flameless atomic absorption spectroscopy. *Bull Environ Contam Toxicol* 36:496-499.
- Roberts CA, Clark JM. 1988. *In vivo* depression of reserve albumin binding capacity by cadmium: A preliminary evaluation. *Life Sci* 42:1369-1374.
- Roels H, Bernard AM, Cardenas A, et al. 1993. Markers of early renal changes induced by industrial pollutants. III. Application to workers exposed to cadmium. *Brit J Ind Med* 50:37-48.
- Roels HA, Hubermont G, Buchet JP, et al. 1978. Placental transfer of lead, mercury, cadmium, and carbon monoxide in women. III. Factors influencing the accumulation of heavy metals in the placenta, and the relationship between maternal concentration in the placenta and in maternal and cord blood. *Environ Res* 16:236-247.
- Roels HA, Lauwerys RR, Bernard AM, et al. 1991. Assessment of the filtration reserve capacity of the kidney in workers exposed to cadmium. *Br J Ind Med* 48:365-374.
- Roels HA, Lauwerys R, Buchet JB, et al. 1981a. Environmental exposure to cadmium and renal function of aged women in three areas of Belgium. *Environ Res* 24:117-130.
- Roels HA, Lauwerys R, Dardenne AN. 1983. The critical level of cadmium in human renal cortex: A reevaluation. *Toxicol Lett* 15:357-360.

9. REFERENCES

- Roels HA, Lauwerys RR, Buchet JP, et al. 1981b. *In vivo* measurement of liver and kidney cadmium in workers exposed to this metal: Its significance with respect to cadmium in blood and urine. *Environ Res* 26:217-240.
- Roels HA, Lauwerys RR, Buchet JP, et al. 1989. Health significance of cadmium induced renal dysfunction: A five year follow-up. *Br J Ind Med* 46:755-764.
- Roels HA, Van Assche FJ, Oversteyns M, et al. 1997. Reversibility of microproteinuria in cadmium workers with incipient tubular dysfunction after reduction of exposure. *Am J Ind Med* 31(5):645-652.
- Rohr G, Bauchinger M. 1976. Chromosome analysis in cell cultures of the Chinese hamster after application of cadmium sulfate. *Mutat Res* 40:125.
- Rose CS, Heywood PG, Costanzo RM. 1992. Olfactory impairment after chronic occupational cadmium exposure. *J Occup Med* 34(6):600-605.
- Roseman EF, Mills EL, Rutzke M, et al. 1994. Absorption of cadmium from water by North American zebra and quagga mussels (*Bivalvia dreissenidae*). *Chemosphere* 28(4):737-743.
- Roy WR, Krapac IG, Steele JD. 1993. Soil processes and chemical transport. *J Environ Qual* 22:537-543.
- Rozgaj R, Kasuba V, Fucic A. 2002. Genotoxicity of cadmium chloride in human lymphocytes evaluated by the comet assay and cytogenetic tests. *J Trace Elem Med Biol* 16:187-192.
- Rudzki E, Rebandel P, Stroinski J, et al. 1988. Reactions of cadmium. *Contact Dermatitis* 18:183-184.
- Rule KL, Comber SDW, Ross D, et al. 2006. Diffuse sources of heavy metals entering an urban wastewater catchment. *Chemosphere* 63:64-72.
- Rusch GM, O'Grodnick JS, Rinehart WE. 1986. Acute inhalation study in rat of comparative uptake, distribution and excretion of different cadmium containing materials. *Am Ind Hyg Assoc* 47:754-763.
- Rutzke M, Gutenmann WH, Williams SD, et al. 1993. Cadmium and selenium absorption by swiss chard grown in potted composted materials. *Bull Environ Contam Toxicol* 31:416-420.
- Ryu DY, Lee SJ, Park DW, et al. 2004. Dietary iron regulates intestinal cadmium absorption through iron transporters in mice. *Toxicol Lett* 152(1):19-25
- Saaranen M, Kantola M, Saarikoski S, et al. 1989. Human seminal plasma cadmium: Comparison with fertility and smoking habits. *Andrologia* 21:140-145.
- Sakata S, Iwami K, Enoki Y, et al. 1988. Effects of cadmium on *in vitro* and *in vivo* erythropoiesis: Erythroid progenitor cells (CFU-E) iron, and erythropoietin in cadmium-induced iron deficiency anemia. *Exp Hematol* 16:581-587.
- Saleh AI, Remail SW, Milad FM. 1993. Determination of cadmium in water samples by co-precipitation and neutron activation analysis. *J Radioanal Nucl Chem* 168:23-27.
- *Salovsky P, Shopova V, Dancheva V, et al. 1992. Changes in antioxidant lung protection after single intratracheal cadmium acetate instillation in rats. *Human Exp Toxicol* 11:217-232.

9. REFERENCES

- Salpietro CD, Gangemi S, Minciullo PL, et al. 2002. Cadmium concentration in maternal and cord blood and infant birth weight: A study in healthy non-smoking women. *J Perinat Med* 30 (5):395-399.
- *Sanders CL, Mahaffey JA. 1984. Carcinogenicity of single and multiple intratracheal instillations of cadmium oxide in the rat. *Environ Res* 33:227-233.
- Saplakoglu U, Iscan M. 1998. Sister chromatid exchanges in human lymphocytes treated *in vitro* with cadmium in G₀ and S phase of their cell cycles. *Mutat Res* 412:109-114.
- Saplakoglu U, Iscan M, Iscan M. 1997. DNA single-strand breakage in rat lung, liver and kidney after single and combined treatments of nickel and cadmium. *Mutat Res* 394(1-3):133-140.
- *Sarhan MJ, Roels H, Lauwerys R, et al. 1986. Influence of manganese on the gastrointestinal absorption of cadmium in rats. *J Appl Toxicol* 6:313-316.
- Sasser LB, Jarboe GE. 1977. Intestinal absorption and retention of cadmium in neonatal rat. *Toxicol Appl Pharmacol* 41:423-431.
- Sasser LB, Jarboe GE. 1980. Intestine absorption and retention of cadmium in neonatal pigs compared to rats and guinea pigs. *J Nutr* 110:1641-1647.
- Satarug S, Nishijo M, Ujjin P, et al. 2005. Cadmium-induced nephropathy in the development of high blood pressure. *Toxicol Lett* 157(1):57-68.
- Sato K, Iwamasa T, Tsuru T, et al. 1978. An ultrastructural study of chronic cadmium chloride induced neuropathy. *Acta Neuropathol* 41:185-190.
- Sato R, Kido T, Honda R, et al. 2010. Seventeen-year observation on urinary cadmium and β_2 -microglobulin in inhabitants after cessation of cadmium-exposure in Japan. *Bull Environ Contam Toxicol* 84(4):363-367.
- Satzger RD, Bonnin E, Fricke FL. 1984. Development of a quality assurance program for determination of ultratrace background levels and cadmium in raw agricultural crops by differential pulse anodic stripping voltammetry. *J Assoc Off Anal Chem* 67:1138-1140.
- Satzger RD, Clow CS, Bonnin E, et al. 1982. Determination of background levels of lead and cadmium in raw agricultural crops by using differential pulse anodic stripping voltammetry. *J Assoc Off Anal Chem* 65:987-991.
- Saxena DK, Murthy RC, Chandra SV. 1986. Embryotoxic and teratogenic effects of interaction of cadmium and lindane in rats. *Acta Pharmacol Toxicol* 59:175-178.
- Saxena DK, Murthy RC, Singh C, et al. 1989. Zinc protects testicular injury induced by concurrent exposure to cadmium and lead in rats. *Res Commun Chem Pathol Pharmacol* 64:317-329.
- Schafer L, Andersen O, Nielsen JB. 1986. Effects of dietary factors on gastrointestinal Cd absorption in mice. *Acta Pharmacol Toxicol (Copenh)* 59(Suppl 7):549-552.

9. REFERENCES

- Schafer SG, Schwegler U, Schumann K. 1990. Retention of cadmium in cadmium-naive normal and iron-deficient rats as well as in cadmium-induced iron-deficient animals. *Ecotoxicol Environ Saf* 20:71-81.
- Schiestl RH, Gietz RD, Mehta RD, et al. 1989. Carcinogens induce introchromosomal recombination in yeast. *Carcinogenesis* 10:1445-1455.
- Schmitt CJ, Brumbaugh WG. 1990. National contaminant biomonitoring program: Concentrations of arsenic, cadmium, copper, lead, mercury, selenium, and zinc in U.S. freshwater fish, 1976-1984. *Arch Environ Contam Toxicol* 19:731-747.
- Schroeder HA, Mitchener M. 1971. Toxic effects of trace elements on the reproduction of mice and rats. *Arch Environ Health* 23:102-106.
- Schroeder HA, Balassa JJ, Vinton WH. 1964. Chromium, lead, cadmium, nickel, and titanium in mice: Effect on mortality, tumors, and tissue levels. *J Nutr* 83:239-250.
- Schroeder HA, Balassa JJ, Vinton WH. 1965. Chromium, cadmium, and lead in rats: Effects on life span, tumors, and tissue levels. *J Nutr* 86:51-66.
- *Schuhmacher M, Bosque MA, Domingo JL, et al. 1994. Effects of chronic lead and cadmium exposure on blood pressure in occupationally exposed workers. *Biol Trace Elem Res* 41:269-278.
- Schulte-Lobbert FJ, Bohn G. 1977. Determination of cadmium in human milk during lactation. *Arch Toxicol* 37:155-157.
- Schulte-Schrepping KH, Piscator M. 2002. Cadmium and cadmium compounds. Ullmann's encyclopedia of industrial chemistry. Wiley-VCH Verlag GmbH & Co. KGaA. http://www.mrw.interscience.wiley.com/emrw/9783527306732/ueic/article/a04_499/current/pdf. April 29, 2008.
- Schutte R, Nawrot TS, Richart T, et al. 2008. Bone resorption and environmental exposure to cadmium in women: A population study. *Environ Health Perspect* 116:777-783.
- Schwartz GG, Il'yasova D, Ivanova A. 2003. Urinary cadmium, impaired fasting glucose, and diabetes in the NHANES III. *Diabetes Care* 26(2):468-470.
- Scott MC, Chettle DR. 1986. *In vivo* elemental analysis in occupational medicine. *Scand J Work Environ Health* 12:81-96.
- Scott R, Haywood JK, Boddy K, et al. 1980. Whole body calcium deficit in cadmium-exposed workers with hypercalciuria. *Urology* 15:356-359.
- Scott R, Patterson PJ, Burns R, et al. 1978. Hypercalciuria related to cadmium exposure. *Urology* 11:462-465.
- Seidal K, Jørgensen N, Elinder C. 1993. Fatal cadmium induced pneumonitis. *Scand J Work Environ Health* 19:429-431.
- Selypes A, Serenyi P, Boldog I, et al. 1992. Acute and 'long term' genotoxic effects of CdCl₂ on testes of mice. *J Toxicol Environ Health* 36(4):401-409.

9. REFERENCES

- Sendelbach LE, Klaassen CD. 1988. Kidney synthesizes less metallothionein than liver in response to cadmium chloride and cadmium-metallothionein. *Toxicol Appl Pharmacol* 92:95-102.
- Seoane AI, Dulout FN. 2001. Genotoxic ability of cadmium, chromium and nickel salts studied by kinetochore staining in the cytokinesis-blocked micronucleus assay. *Mutat Res* 490(2):99-106.
- Setchell BP, Waites GMH. 1975. The blood-testis barrier. In: Creep RO, Astwood EB, Geiger SR, eds. *Handbook of physiology: Endocrinology V*. Washington, DC: American Physiological Society, 143-172.
- Shaham J, Rosenboim J, Ophire D, et al. 1993. The correlation between blood and urine level of cadmium and nasal and paranasal sinuses disorders. *Int Arch Occup Environ Health* 65:S91-S93.
- Shaikh ZA. 1982. Metallothionein as a storage protein for cadmium: Its toxicological implications. *Dev Toxicol Environ Sci* 9:69-76.
- Shaikh ZA, Smith JC. 1976. The biosynthesis of metallothionein rat liver and kidney after administration of cadmium. *Chem Biol Interact* 15:327-336.
- Shaikh ZA, Smith JC. 1980. Metabolism of orally ingested cadmium in humans. In: Holmstedt B, Lauwerys R, Mercier M, et al., eds. *Mechanisms of toxicity and hazard evaluation*. New York, NY: Elsevier/North-Holland Biomedical Press, 569-574.
- Shaikh ZA, Smith LM. 1984. Biological indicators of cadmium exposure and toxicity. *Experientia* 40:36-43.
- Shaikh ZA, Tang W. 1999. Protection against chronic cadmium toxicity by glycine. *Toxicology* 132(2-3):93-103.
- Shaikh ZA, Harnett KM, Perlin SA, et al. 1989. Chronic cadmium intake results in dose-related excretion of metallothionein in urine. *Experientia* 45:146-148.
- Shaikh ZA, Jordan SA, Tang W. 1999a. Protection against chronic cadmium toxicity by calorie restriction. *Toxicology* 133:93-103.
- Shaikh ZA, Jordan SA, Tewari PC. 1993. Cadmium disposition and methallothionein induction in mice: Strain, sex, age, and dose dependent differences. *Toxicology* 80:51-70.
- Shaikh ZA, Tohyama C, Noland CV. 1987. Occupational exposure to cadmium: Effect on metallothionein and other biological indices of exposure and renal function. *Arch Toxicol* 59:360-364.
- Shaikh ZA, Vu TI, Zaman K. 1999b. Oxidative stress as a mechanism of chronic cadmium-induced hepatotoxicity and renal toxicity and protection by antioxidants. *Toxicol Appl Pharmacol* 154:256-263.
- Shaikh ZA, Zaman K, Tang W, et al. 1999c. Treatment of chronic cadmium nephrotoxicity by *N*-acetyl cystine. *Toxicol Lett* 104(1-2):137-142.
- Shanbaky MM. 1973. A radiotracer distribution study of repeated administration of cadmium in the Albino rat. M.S. Thesis, Purdue University.

9. REFERENCES

- Shank KE, Vetter RJ, Ziemer PL. 1977. A mathematical model of cadmium transport in a biological system. *Environ Res* 13:209-214.
- Sharma RP, Kjellström T, McKenzie JM. 1983. Cadmium in blood and urine among smokers and nonsmokers with high cadmium intake via food. *Toxicology* 29:163-171.
- Sharma RP, McKenzie JM, Kjellström T. 1982. Analysis of submicrogramme levels of cadmium in whole blood, urine, and hair by graphite furnace atomic absorption spectroscopy. *J Anal Toxicol* 6:135-138.
- Sharon IM. 1988. The significance of teeth in pollution detection. *Perspect Biol Med* 32:124-131.
- Shevchenko V, Lisitzin A, Vinogradova A, et al. 2003. Heavy metals in aerosols over the seas of the Russian Arctic. *Sci Total Environ* 306:11-25.
- Shigematsu I. 1984. The epidemiological approach to cadmium pollution in Japan. *Ann Acad Med Singapore*. 13:231-236.
- Shimbo S, Zhang Z, Moon C, et al. 2000. Correlation between urine and blood concentrations, and dietary intake of cadmium and lead among women in the general population of Japan. *Int Arch Occup Environ Health* 73:163-170.
- Shimizu M, Morita S. 1990. Effects of fasting on cadmium toxicity, glutathione metabolism, and metallothionein synthesis in rats. *Toxicol Appl Pharmacol* 103:28-39.
- Shimizu A, Kobayashi E, Suwazono Y, et al. 2006. Estimation of benchmark doses for urinary cadmium based on β_2 -microglobulin excretion in cadmium-polluted regions of the Kakehashi River basin, Japan. *Int J Environ Health Res* 16(5):329-337.
- Shin M, Paek D, Yoon C. 2011. The relationship between the bone mineral density and urinary cadmium concentration of residents in an industrial complex. *Environ Res* 111(1):101-109.
- Shipman DL. 1986. Cadmium food poisoning in a Missouri school. *J Environ Health* 49:89.
- Shiraishi Y, Yoshida TH. 1972. Chromosomal abnormalities in cultured leucocyte cells from Itai-itai disease patients. *Proc Japan Acad* 48:248-251.
- Shiraishi Y, Kurahashi H, Yoshida TH. 1972. Chromosomal aberrations in cultured human leucocytes induced by cadmium sulfide. *Proc Japan Acad* 48:133-137.
- Shiwen C, Lin Y, Zhineng H, et al. 1990. Cadmium exposure and health effects among residents in an irrigation area with ore dressing wastewater. *Sci Total Environ* 90:67-73.
- *Shukla GS, Hussain T, Srivastava RS, et al. 1988a. Diagnostic significance of erythrocyte antioxidative enzymes in cadmium toxicity. *Biochem Arch* 4:429-436.
- Sidhu M, Sharma M, Bhatia M, et al. 1993. Effect of chronic cadmium exposure on glutathione S-transferase and glutathione peroxidase activities in Rhesus monkey the role of selenium. *Toxicology* 83:203-213.

9. REFERENCES

- SI/EPA. 2007. Cadmium. The Science Inventory. U.S. Environmental Protection Agency. <http://cfpub.epa.gov/si/sciencequery.cfm>. April 23, 2008.
- Sikorski R, Paszkowski T, Radomanski T, et al. 1989. Cadmium contamination of early human milk. *Gynecol Obstet Invest* 27:91-93.
- Sileo L, Beyer WN. 1985. Heavy metals in white-tailed deer living near a zinc smelter in Pennsylvania. *J Wildlife Diseases* 21:289-296.
- *Simmer K, Carlsson L, Thompson RPH. 1992. The effects of cadmium on zinc in the pregnant guinea pig. *Trace Elem Med* 9(3):109-112.
- Singh BR. 1994. Trace element availability to plants in agricultural soils, with special emphasis on fertilizer inputs. *Environ Rev* 2:133-146.
- Singh PK, Jones MM, Kostial K, et al. 1996. *In vivo* cadmium mobilization by three novel bis (carbodithioates). *Chem Res Toxicol* 9(1):313-317.
- *Singh PK, Jones SG, Gale GR, et al. 1990. Selective removal of cadmium from aged hepatic and renal deposits: N-substituted taloocamine dithiocarbamates as cadmium mobilizing agents. *Chem Biol Interact* 74:79-91.
- Skerfving S, Nilsson U. 1992. Assessment of accumulated body burden of metals. *Toxicol Lett* 64/65:17-24.
- Skog E, Wahlberg JE. 1964. A comparative investigation of the percutaneous absorption of metal compounds in the guinea pig by means of the radioactive isotopes: ⁵¹Cr, ⁵⁸Co, ⁶⁵Zn, ^{110m}Ag, ^{115m}Cd, ²⁰³Hg. *J Invest Dermatol* 43:187-192.
- Smith JP, Smith JC, McCall AJ. 1960. Chronic poisoning from cadmium fume. *J Pathol Bacteriol* 80:287-296.
- *Smith NJ, Topping MD, Stewart JD, et al. 1986. Occupational cadmium exposure in jig solderers. *Br J Ind Med* 43:663-666.
- Smith SR. 1994. Effect of soil pH on availability to crops of metals in sewage sludge-treated soils. II. Cadmium uptake by crops and implications for human dietary intake. *Environ Pollut* 86:5-13.
- Smith TJ, Anderson RJ, Reading JC. 1980. Chronic cadmium exposures associated with kidney function effects. *Am J Ind Med* 1:319-337.
- Smith TJ, Petty TL, Reading JC, et al. 1976. Pulmonary effects of chronic exposure to airborne cadmium. *Am Rev Resp Dis* 114:161-169.
- Snider GL, Hayes JA, Korthy AL, et al. 1973. Centrilobular emphysema experimentally induced by cadmium chloride aerosol. *Am Rev Resp Dis* 108:40-48.
- *Snider GL, Lucey EC, Faris B, et al. 1988. Cadmium-chloride-induced air-space enlargement with interstitial pulmonary fibrosis is not associated with destruction of lung elastin. Implications for the pathogenesis of human emphysema. *Am Rev Respir Dis* 137:918-923.

9. REFERENCES

- Sorahan T. 1987. Mortality from lung cancer among a cohort of nickel cadmium battery workers: 1946-1984. *Br J Ind Med* 44:803-809.
- Sorahan T, Esmen NA. 2004. Lung cancer mortality in UK nickel-cadmium battery workers, 1947-2000. *Occup Environ Med* 61(2):108-116.
- Sorahan T, Lancashire R. 1994. Lung cancer findings from the NIOSH study of United States cadmium recovery workers: A cautionary note. *Occup Environ Med* 51(2):139-140.
- Sorahan T, Lancashire RJ. 1997. Lung cancer mortality in a cohort of workers employed at a cadmium recovery plant in the United States: An analysis with detailed job histories. *Occup Environ Med* 54(3):194-201.
- Sorahan T, Waterhouse JAH. 1983. Mortality study of nickel-cadmium battery workers by the method of regression models in life tables. *Br J Ind Med* 40:293-300.
- *Sorahan T, Waterhouse JAH. 1985. Cancer of prostate among nickel-cadmium battery workers. *Lancet* 1(8426):459.
- Sorahan T, Lister A, Gilthorpe MS, et al. 1995. Mortality of copper cadmium alloy workers with special reference to lung cancer and non-malignant diseases of the respiratory system, 1946-92. *Occup Environ Med* 52(12):804-12.
- Sorell TL, Graziano JH. 1990. Effect of oral cadmium exposure during pregnancy on maternal and fetal zinc metabolism in the rat. *Toxicol Appl Pharmacol* 102:537-545.
- Sporn A, Dinu I, Stoenescu L. 1970. Influence of cadmium administration on carbohydrate and cellular energetic metabolism in the rat liver. *Rev Roum Biochim* 7:299-305.
- Sprague JB. 1986. Toxicity and tissue concentrations of lead, zinc, and cadmium for marine molluscs and crustaceans. Research Triangle Park, NC: International Lead Zinc Research Organization, Inc., 1-74.
- Squibb KS, Pritchard JB, Fowler BA. 1984. Cadmium-metallothionein nephropathy: Relationships between ultrastructural/biochemical alterations and intracellular cadmium binding. *J Pharmacol Exp Ther* 229:311-321.
- SRI. 2007. Directory of chemical producers. United States of America. Menlo Park, CA: SRI Consulting, 503; 799-800.
- *Srivastava RC, Ahmad I, Kaur G, et al. 1988. Alterations in the metabolism of endogenous trace metals due to cadmium, manganese and nickel effect of partial hepatectomy. *J Environ Sci Health A23*:95-101.
- Stacey NH, Craig G, Muller L. 1988. Effects of cadmium on natural killer and killer cell functions *in vivo*. *Environ Res* 45:71-77.
- Staessen J, Bulpitt CJ, Roels H, et al. 1984. Urinary cadmium and lead and their relationship to blood pressure in a population with low average exposure. *Br J Ind Med* 4:241-248.
- Staessen J, Kuznetsova T, Roels HA, et al. 2000. Exposure to cadmium and conventional and ambulatory blood pressures in a prospective population study. *Am J Hypertens* 13(2):146-156.

9. REFERENCES

- Staessen J, Lauwerys R. 1993. Health effects of environmental exposure to cadmium in a population study. *J Hum Hypertens* 7:195-199.
- Staessen JA, Roels HA, Emelianov D, et al. 1999. Environmental exposure to cadmium, forearm bone density, and risk of fractures: Prospective population study. *Lancet* 353(9159):1140-1144.
- Stayner L, Smith R, Schorr T, et al. 1993. Letter to the editor. *Ann Epidemiol* 3(1):114-116.
- Stayner L, Smith R, Thun M, et al. 1992a. A dose-response analysis and quantitative assessment of lung cancer risk and occupational cadmium exposure. *Ann Epidemiol* 2(3):177-194.
- *Stayner L, Smith R, Thun M, et al. 1992b. A quantitative assessment of lung cancer risk and occupational cadmium exposure. In: Nordberg GF, Herber RFM, Alessio L, eds. *Cadmium in the human environment: Toxicity and carcinogenicity*. Lyon, France: International Agency for Research on Cancer, 447-455.
- Steenkamp PA, Coetzee PP. 1994. Simultaneous determination of toxic heavy metals in organic matrices using reversed-phase high-performance liquid chromatography. *S Afr J Chem* 47(1):29-32.
- Steibert E, Krol B, Sowa B, et al. 1984. Cadmium-induced changes in the histoenzymatic activity in liver, kidney and duodenum of pregnant rats. *Toxicol Lett* 20:127-132.
- Steinnes E, Friedland AJ. 2006. Metal contamination of natural surface soils from long-range atmospheric transport: Existing and missing knowledge. *Environ Rev* 14:169-186.
- Stowe HD, Wilson M, Goyer RA. 1972. Clinical and morphological effects of oral cadmium toxicity in rabbits. *Arch Pathol* 94:389-405.
- Stroh A. 1993. Determination of Pb and Cd in whole blood using isotope dilution ICP-MS. *Atom Spectrosc* 14(5):141-143.
- Struempfer RE, Larson GE, Rimland B. 1985. Hair mineral analysis and disruptive behavior in clinically normal young men. *J Learn Disabil* 18:609-612.
- Stutz DR, Janusz SJ. 1988. *Hazardous materials injuries: A handbook for pre-hospital care*. 2nd edition. Beltsville, MD: Bradford Communications Corporation, 21, 228-229.
- Subramanian KS, Meranger JC. 1981. A rapid electrothermal atomic absorption spectrophotometric method for cadmium and lead in human whole blood. *Clin Chem* 27:1866-1871.
- Subramanian KS, Meranger JC, MacKeen JE. 1983. Graphite furnace atomic absorption spectrometry with matrix modification for determination of cadmium and lead in human urine. *Anal Chem* 55:1064-1067.
- *Sugawara N, Sugawara C. 1987. Role of mucosal metallothionein preinduced by oral Cd or Zn on the intestinal absorption of a subsequent Cd dose. *Bull Environ Contam Toxicol* 38:295-299.
- Sumino K, Hayakawa K, Shibata T, et al. 1975. Heavy metals in normal Japanese tissues. *Arch Environ Health* 30:487-494.

9. REFERENCES

- Suresh A, Sivaramakrishna B, Radhakrishnaiah K. 1993. Patterns of cadmium accumulation in the organs of fry and fingerlings of freshwater fish *Cyprinus carpio* following cadmium exposure. *Chemosphere* 26(5):945-953.
- Suter KE. 1975. Studies on the dominant-lethal and fertility effects of the heavy metal compounds methylmercuric hydroxide, mercuric chloride, and cadmium chloride in male and female mice. *Mutat Res* 30:365-374.
- Sutou S, Yamamoto K, Sendota H, et al. 1980. Toxicity, fertility, teratogenicity, and dominant lethal tests in rats administered cadmium subchronically. III. Fertility, teratogenicity, and dominant lethal tests. *Ecotoxicol Environ Saf* 4:51-56.
- Suwazono Y, Kobayashi E, Okubo Y, et al. 2000. Renal effects of cadmium exposure in cadmium nonpolluted areas in Japan. *Environ Res* 84(Sect A):44-55.
- Suwazono Y, Nogawa K, Uetani M, et al. 2011a. Application of the hybrid approach for estimating the benchmark dose of urinary cadmium for adverse renal effects in the general population of Japan. *J Appl Toxicol* 31(1):89-93.
- Suwazono Y, Nogawa K, Uetani M, et al. 2011b. Application of the hybrid approach to the benchmark dose of urinary cadmium as the reference level for renal effects in cadmium polluted and non-polluted areas in Japan. *Environ Res* 111(2):312-314.
- Suwazono Y, Nogawa K, Uetani M, et al. 2011c. Reassessment of the threshold of urinary cadmium by using hybrid approach in a cadmium non-polluted area in Japan. *Int J Hyg Environ Health* 214(2):175-178.
- Suwazono Y, Saloman S, Vahter M, et al. 2006. Benchmark dose for cadmium-induced renal effects in humans. *Environ Health Perspect* 114:1072-1076.
- Suwazono Y, Uetani M, Akesson A, et al. 2010. Recent applications of benchmark dose method for estimation of reference cadmium exposure for renal effects in man. *Toxicol Lett* 198(1):40-43.
- Suzuki CAM, Cherian MG. 1987. Renal toxicity of cadmium-metallothionein and enzymuria in rats. *J Pharmacol Exp Ther* 240:314-319.
- Swaddiwudhipong, W; Mahasakpan, P; Limpatanachote, P; et al. 2010. Correlations of urinary cadmium with hypertension and diabetes in persons living in cadmium-contaminated villages in northwestern Thailand: A population study. *Environ Res* 110(6):612-616.
- Swaddiwudhipong, W; Mahasakpan, P; Limpatanachote, P; et al. 2011. An association between urinary cadmium and urinary stone disease in persons living in cadmium-contaminated villages in northwestern Thailand: A population study. *Environ Res* 111(4):579-583.
- Sweet CW, Vermette SJ, Landsberger S. 1993. Sources of toxic trace elements in urban air in Illinois. *Environ Sci Technol* 27(12):2502-2510.
- Sweet CW, Weiss A, Vermette SJ. 1998. Atmospheric deposition of trace metals at three sites near the Great Lakes. *Water Air Soil Pollut* 103:423-439.

9. REFERENCES

Swiergosz-Kowalewska R. 2001. Cadmium distribution and toxicity in tissues of small rodents. *Microsc Res Tech* 55(3):208-222.

*Szymanska JA, Bem EM, Piotrowski JK, et al. 1989. Renal binding of cadmium in the rat following intragastric exposure. *Toxicology* 55:339-348.

Takagi Y, Matsuda S, Imai S, et al. 1988. Survey of trace elements in human nails: An international comparison. *Bull Environ Contam Toxicol* 41:690-695.

*Takebayashi S, Harada T, Kamura S, et al. 1987. Cadmium-induced osteopathy: Clinical and autopsy findings of four patients. *Appl Pathol* 5:190-197.

Takenaka S, Karg E, Kreyling WG, et al. 2004. Fate and toxic effects of inhaled ultrafine cadmium oxide particles in the rat lung. *Inhal Toxicol* 16:83-92.

Takenaka S, Oldiges H, Konig H, et al. 1983. Carcinogenicity of cadmium chloride aerosols in Wistar rats. *J Natl Cancer Inst* 70:367-373.

Tandon L, Ni BF, Ding XX, et al. 1994. RNAA for arsenic, cadmium, copper, and molybdenum in CNS tissues from subjects with age related neurodegenerative disease. *J Radionanal Nucl Chem* 179(2):331-339.

Tang XM, Chen XQ, Zhang JX, et al. 1990. Cytogenetic investigation in lymphocytes of people living in cadmium-polluted areas. *Mutat Res* 241:243-249.

Teeyakasem W, Nishijo M, Honda R, et al. 2007. Monitoring of cadmium toxicity in a Thai population with high-level environmental exposure. *Toxicol Lett* 169:185-195.

Telišman S, Cvitkovic P, Jurasovic J, et al. 2000. Semen quality and reproductive endocrine function in relation to biomarkers of lead, cadmium, zinc, and copper in men. *Environ Health Perspect* 108:45-53.

Tellez-Plaza M, Navas-Acien A, Crainiceanu CM, et al. 2008. Cadmium exposure and hypertension in the 1999-2004 National Health and Nutrition Examination Survey (NHANES). *Environ Health Perspect* 116(1):51-56.

Tellez-Plaza, M; Navas-Acien, A; Crainiceanu, CM; et al. 2010. Cadmium and peripheral arterial disease: Gender differences in the 1999-2004 US National Health and Nutrition Examination Survey. *Am J Epidemiol* 172(6):671-681.

Terracio L, Nachtigal M. 1988. Oncogenicity of rat prostate cells transformed *in vitro* with cadmium chloride. *Arch Toxicol* 61:450-456.

Tewari PC, Jain VK, Ashquin M, et al. 1986b. Influence of protein deficiency on cadmium toxicity in rats. *Arch Environ Contam Toxicol* 15:409-415.

Thatcher RW, Lester ML, McAlaster R, et al. 1982. Effects of low levels of cadmium in lead on cognitive functioning in children. *Arch Environ Health* 37:159-166.

Thomas K, Colborn T. 1992. Organochlorine endocrine disruptors in human tissue. In: Colborn T, Clement C, eds. *Chemically induced alterations in sexual and functional development: The wildlife/human connection*. Princeton, NJ: Princeton Scientific Publishing, 365-394.

9. REFERENCES

- Thomas, LD; Hodgson, S; Nieuwenhuijsen, M; et al. 2009. Early kidney damage in a population exposed to cadmium and other heavy metals. *Environ Health Perspect* 117(2):181-184.
- Thornton I. 1992. Sources and pathways of cadmium in the environment. In: Nordberg GF, Herber RFM, Alessio L, eds. *Cadmium in the human environment: Toxicity and carcinogenicity*. IARC Scientific Publications No. 118. Lyon, France: International Agency for Research on Cancer, 149-162.
- Thun MJ, Osorio AM, Schober S, et al. 1989. Nephropathy in cadmium workers: Assessment of risk from airborne occupational exposure to cadmium. *Br J Ind Med* 46:689-697.
- Thun MJ, Schnorr TM, Smith A, et al. 1985. Mortality among a cohort of U.S. cadmium production workers--an update. *J Natl Cancer Inst* 74:325-333.
- Toffoletto F, Apostoli P, Ghezzi I, et al. 1992. Ten-year follow-up of biological monitoring of cadmium-exposed workers. In: Nordberg GF, Herber RFM, Alessio L, eds. *Cadmium in the human environment: Toxicity and carcinogenicity*. Geneva: International Agency for Research on Cancer, 107-111
- Tohyama C, Kobayashi E, Saito H, et al. 1986. Urinary microglobulin as an indicator protein or renal tubular dysfunction caused by environmental cadmium exposure. *J Appl Toxicol* 6:171-178.
- Tohyama C, Mitane Y, Kobayashi E, et al. 1988. The relationships of urinary metallothionein with other indicators of renal dysfunction in people living in a cadmium-polluted area in Japan. *J Appl Toxicol* 8:15-21.
- Tohyama C, Shaikh ZA, Ellis KJ, et al. 1981. Metallothionein excretion in urine upon cadmium exposure: Its relationship with liver and kidney cadmium. *Toxicology* 22:181-191.
- Tomera JF, Harakal C. 1988. Effects of cadmium ingestion on blood pressure and ventricular mass in rabbits. *Drug Nutr Interact* 5:365-72.
- Topping MD, Forster HW, Dolman C, et al. 1986. Measurement of urinary retinol-binding protein by enzyme-linked immunosorbent assay, and its application to detection of tubular proteinuria. *Clin Chem* 32:1863-1866.
- Townshend RH. 1982. Acute cadmium pneumonitis: A 17-year follow-up. *Br J Ind Med* 39:411-412.
- Trevisan A, Gardin C. 2005. Nephrolithiasis in a worker with cadmium exposure in the past. *Int Arch Occup Environ Health* 78(8):670-672.
- TRI09. 2011. TRI explorer: Providing access to EPA's toxics release inventory data. Washington, DC: Office of Information Analysis and Access. Office of Environmental Information. U.S. Environmental Protection Agency. Toxics Release Inventory. <http://www.epa.gov/triexplorer/>. September 19, 2011.
- Truska P, Rosival L, Balazova G, et al. 1989. Blood and placental concentrations of cadmium, lead, and mercury in mothers and their newborns. *J Hyg Epidemiol Microbiol Immunol* 33:141-147.
- Trzcinka-Ochocka M, Jakubowski M, Halatek T, et al. 2002. Reversibility of microproteinuria in nickel-cadmium battery workers after removal from exposure. *Int Arch Occup Environ Health* 75(Suppl):S101-S106.

9. REFERENCES

- Trzcinka-Ochocka M, Jakubowski M, Razniewska G, et al. 2004. The effects of environmental cadmium exposure on kidney function: The possible influence of age. *Environ Res* 95(2):143-150.
- Trzcinka-Ochocka, M; Jakubowski, M; Szymczak, W; et al. 2010. The effects of low environmental cadmium exposure on bone density. *Environ Res* 110(3):286-293.
- Tsukahara T, Ezaki T, Moriguchi J, et al. 2003. No significant effect of iron deficiency on cadmium body burden or kidney dysfunction among women in the general population in Japan. *Int Arch Occup Environ Health* 76:275-281.
- *Tsuritani I, Honda R, Ishizaki M, et al. 1994. Serum bone-type alkaline phosphatase activity in women living in a cadmium-polluted area. *Toxicol Lett* 71:209-216.
- Tsvetkova RP. 1970. [Materials on the study of the influence of cadmium compounds on the generative function.] *Gig Tr Prof Zabol* 14:31-33. (Russian)
- Tulley RT, Lehmann HP. 1982. Method for the simultaneous determination of cadmium and zinc in whole blood by atomic absorption spectrophotometry and measurement in normotensive and hypertensive humans. *Clinica Chimica Acta* 122:189-202.
- UN. 1985. Treatment and disposal methods for waste chemicals. International Register of Potentially Toxic Chemicals. Geneva, Switzerland: United Nations Environment Programme.
- Uno T, Kobayashi E, Suwazono Y, et al. 2005. Health effects of cadmium exposure in the general environment in Japan with special reference to the lower limit of the benchmark dose as the threshold level of urinary cadmium. *Scand J Work Environ Health* 31(4):307-315.
- U.S. Bureau of Mines. 1990. Mineral industry surveys. Cadmium in 1989. Washington, DC: U.S. Bureau of Mines, 1-5.
- USDA. 2012. Table 5. U.S. consumption of selected phosphate and potash fertilizers. Economic research service. United States Department of Agriculture. <http://www.ers.usda.gov/data-products/fertilizer-use-and-price.aspx#26720>. September 11, 2012.
- USGS. 1985. Cadmium, atomic absorption spectrometric, direct. In: Fishman MJ, Friedman LC, eds. Methods for the determination of inorganic substances in water and fluvial sediments, techniques of water-resources investigations of the United States Geological Survey, Book 5, Chapter A1. U.S. Geological Survey. infotrek.er.usgs.gov/pls/nemi_pdf/nemi_data.download_pdf?p_file=1333. May 14, 2008.
- USGS. 1996. Methods of analysis by the U.S. Geological Survey National Water Quality Laboratory-Preparation procedure for aquatic biological material determined for trace metals. Denver, CO: U.S. Geological Survey. Open-File Report 96-362. <http://pubs.er.usgs.gov/usgspubs/ofr/ofr96362>. May 26, 2008.
- USGS. 1997. Minerals yearbook: Cadmium. Reston, Virginia: U.S. Geological Survey.
- USGS. 1998a. Methods of analysis by the U.S. Geological Survey National Water Quality Laboratory-Determination of elements in whole-water digests using inductively coupled plasma-optical emission spectrometry and inductively coupled plasma-mass spectrometry. Denver, CO: U.S. Geological Survey. Open-File Report 98-165. <http://pubs.er.usgs.gov/usgspubs/ofr/ofr98165>. May 26, 2008.

9. REFERENCES

- USGS. 1998b. Water quality in the Hudson River basin. New York and adjacent states, 1992-1995. U.S. Geological Survey. Circular 1165. <http://ny.water.usgs.gov/projects/hdsn/report/Circular1165.pdf>. April 17, 2008.
- USGS. 1999. Mineral commodity summary: Cadmium. Reston, Virginia: U.S. Geological Survey.
- USGS. 2007. 2006 minerals yearbook. Cadmium. U.S. Geological Survey. <http://minerals.usgs.gov/minerals/pubs/commodity/cadmium/myb1-2006-cadmi.pdf>. April 29, 2008.
- USGS. 2008. Cadmium. Mineral commodity summaries. U.S. Geological Survey. <http://minerals.usgs.gov/minerals/pubs/commodity/cadmium/mcs-2008-cadmi.pdf>. April 29, 2008.
- Vahter M, Berglund M, Nermell B, et al. 1996. Bioavailability of cadmium from shellfish and mixed diet in women. *Toxicol Appl Pharmacol* 136(2):332-341.
- Valois AA, Webster WS. 1989. The choroid plexus as a target site for cadmium toxicity following chronic exposure in the adult mouse: An ultrastructural study. *Toxicology* 55:193-205.
- Valverde M, Fortoul TI, Diaz-Barriga F, et al. 2000. Induction of genotoxicity by cadmium chloride inhalation in several organs of CD-1 mice. *Mutagenesis* 15(2):109-114.
- Vanderpool RA, Reeves PG. 2001. Cadmium absorption in women fed processed edible sunflower kernels labeled with a stable isotope of cadmium, ^{113}Cd . *Environ Res* 87:69-80.
- Van Gestel CA, Adema DM, de Boer JL, et al. 1988. The influence of soil clean-up on the bioavailability of metals. In: Wolf K, Van den Brink WJ, Colon FJ, eds. *Contaminated soil '88*. The Netherlands: Kluser Academic Publishers, 63-66.
- van Hattum B, de Voogt P, van den Bosch L, et al. 1989. Bioaccumulation of cadmium by the freshwater isopod *Asellus aquaticus* (L.) from aqueous and dietary sources. *Environ Pollut* 62:129-152.
- Vanhoe H, Dams R, Versieck J. 1994. Use of inductively coupled plasma mass spectrometry for the determination of ultra-trace elements in human serum. *J Anal Atom Spectrom* 9:23-31.
- van Sittert NJ, Ribbens PH, Huisman B, et al. 1993. A nine year follow-up study of renal effects in workers exposed to cadmium in a zinc ore refinery. *Br J Ind Med* 50:603-612.
- *Varga B, Zsolnai B, Paksy K, et al. 1993. Age dependent accumulation of cadmium in the human ovary. *Reprod Toxicol* 7(3):225-228.
- Vasudev V, Krishnamurthy NB. 1979. Dominant lethals induced by cadmium in *Drosophila melanogaster*. *Curr Sci* 48:1007-1008.
- Verschoor M, Herber R, van Hemmen, et al. 1987. Renal function of workers with low-level cadmium exposure. *Scand J Work Environ Health* 13:232-238.
- Vestergaard P, Shaikh ZA. 1994. The nephrotoxicity of intravenously administered cadmium-metallothionein: Effect of dose, mode of administration, and preexisting renal cadmium burden. *Toxicol Appl Pharmacol* 126:240-247.

9. REFERENCES

- Viau C, Bernard A, Lauwerys R, et al. 1984. Cadmium compound analgesics, and the chronic progressive nephrosis in the female Sprague-Dawley rat. *Arch Toxicol* 55:247-249.
- Viccellio P. 1998. Cadmium, mercury, and arsenic. In: *Emergency toxicology*. 2nd ed. Philadelphia, PA: Lippincott-Raven Publishers, 379-380.
- Vidovic M, Sadibasic A, Cupic S, et al. 2005. Cd and Zn in atmospheric deposit, soil, wheat, and milk. *Environ Res* 97:26-31.
- Vieira I, Sonnier M, Cresteil T. 1996. Developmental expression of CYP2E1 in the human liver: Hypermethylation control of gene expression during the neonatal period. *Eur J Biochem* 238(2):476-483.
- Vos G, Lammers H, Kan CA. 1990. Cadmium and lead in muscle tissue and organs of broilers, turkeys and spent hens, and in mechanically deboned poultry meat. *Food Addit Contam* 7:83-92.
- *Waalkes MP. 1986. Effect of dietary zinc deficiency on the accumulation of cadmium and metallothionein and selected tissues of the rat. *J Toxicol Environ Health* 18:301-313.
- Waalkes MP, Goering PL. 1990. Metallothionein and other cadmium-binding proteins: Recent developments. *Chem Res Toxicol* 3:281-288.
- Waalkes MP, Klaassen CD. 1985. Concentration of metallothionein in major organs of rats after administration of various metals. *Fundam Appl Toxicol* 5:473-477.
- Waalkes MP, Rehm S. 1992. Carcinogenicity of oral cadmium in the male Wistar (WF/NCr) rat: Effect of chronic dietary zinc deficiency. *Fundam Appl Toxicol* 19:512-520.
- Waalkes MP, Rehm S. 1994a. Chronic toxic and carcinogenic effects of cadmium chloride in male DBA/2Ncr and NFS/Ncr mice: Strain dependent association with tumors of the hematopoietic system, injection site, liver, and lung. *Fundam Appl Toxicol* 23:21-31.
- Waalkes MP, Rehm S. 1994b. Carcinogenic and chronic toxic effects of single and multiple subcutaneous doses of cadmium chloride in male BALB/c mice. *Toxic Subst J* 13:97-111.
- Waalkes MP, Coogan TP, Barter RA. 1992. Toxicological principles of metal carcinogenesis with special emphasis on cadmium. *Crit Rev Toxicol* 22(3,4):175-201.
- Waalkes MP, Diwan BA, Weghorst CM, et al. 1993. Further evidence of the tumor suppressive effects of cadmium in the B6C3F1 mouse liver and lung: Late stage vulnerability of tumors to cadmium and the role of metallothionein. *J Pharmacol Exp Ther* 266(3):1656-1663.
- Waalkes MP, Rehm S, Riggs CW, et al. 1989. Cadmium carcinogenesis in male Wistar [CrI:(WI)BR] rats: Dose-response analysis of effects of zinc on tumor induction in the prostate, in the testes, and at the injection site. *Cancer Res* 49:4282-4288.
- Waalkes MP, Watkins JB, Klaassen CD. 1983. Minimal role of metallothionein in decreased chelator efficacy for cadmium. *Toxicol Appl Pharmacol* 68:392-398.
- *Wahba ZZ, Waalkes MP. 1990. Cadmium-induced route-specific alterations in essential trace element homeostasis. *Toxicol Lett* 54:77-81.

9. REFERENCES

- Wahlberg JE, Boman A. 1979. Guinea pig maximization test method-cadmium chloride. *Contact Dermatitis* 5:405.
- Wahlberg JE. 1965. Percutaneous toxicity of metal compounds. *Arch Environ Health* 11:201-204.
- Wahlberg JE. 1977. Routine patch testing with cadmium chloride. *Contact Dermatitis* 3:293-296.
- Wang C, Bhattacharyya MH. 1993. Effect of cadmium on bone calcium and ^{45}Ca in nonpregnant mice on a calcium-deficient diet: evidence of direct effect of cadmium on bone. *Toxicol Appl Pharmacol* 120:228-239.
- Wang XP, Foulkes EC. 1984. Specificity of acute effects of cadmium on renal function. *Toxicology* 30:243-247.
- Wang C, Brown S, Bhattacharyya MH. 1994. Effect of cadmium on bone calcium and ^{45}Ca in mouse dams on a calcium-deficient diet: Evidence of itai-itai-like syndrome. *Toxicol Appl Pharmacol* 127:320-330.
- Wang C, Fang Y, Peng S, et al. 1999. Synthesis of novel chelating agents and their effect on cadmium decorporation. *Chem Res Toxicol* 12:331-334.
- Wang H, Zhu G, Shi Y, et al. 2003. Influence of environmental cadmium exposure on forearm bone density. *J Bone Miner Res* 18(3):553-560.
- Watanabe M, Shiroishi K, Nishino H, et al. 1986. An experimental study on the long-term effect of cadmium in mice fed cadmium-polluted rice with special reference to the effect of repeated reproductive cycles. *Environ Res* 40:25-46.
- Watanabe T, Endo A. 1982. Chromosome analysis of preimplantation embryos after cadmium treatment of oocytes at meiosis. I. *Environ Mutagen* 4:563-567.
- Watanabe T, Kasahara M, Nakatsuka H, et al. 1987. Cadmium and lead contents of cigarettes produced in various areas of the world. *Sci Total Environ* 66:29-37.
- *Watanabe T, Nakatsuka H, Seiji K, et al. 1989. Blood cadmium levels in the populations of Masan, Korea, and Miyagi, Japan: An inter-regional comparison. *Toxicol Lett* 47:155-163.
- Watanabe T, Shimada T, Endo A. 1979. Mutagenic effects of cadmium on mammalian oocyte chromosomes. *Mutat Res* 67:349-356.
- Watanabe T, Shimbo S, Moon CS, et al. 1996. Cadmium contents in rice samples from various areas in the world. *Sci Total Environ* 184(3):191-196.
- Watanabe Y, Kobayashi E, Okubo Y, et al. 2002. Relationship between cadmium concentration in rice and renal dysfunction in individual subjects of the Jinzu River basin determined using a logistic regression analysis. *Toxicology* 172:93-101.
- Webster WS. 1978. Cadmium-induced fetal growth retardation in the mouse. *Arch Environ Health* 33:36-42.

9. REFERENCES

- Weidenhamer JD, Miller J, Guinn D, et al. 2011. Bioavailability of cadmium in inexpensive jewelry. *Environ Health Perspect* 119(7):1029-1033.
- Weigel HJ, Jager HJ, Elmadfa I. 1984. Cadmium accumulation in rat organs after extended oral administration with low concentrations of cadmium oxide. *Arch Environ Contam Toxicol* 13:279-287.
- Welz B, Xu S, Sperling M. 1991. Flame atomic absorption spectrometric determination of cadmium, cobalt, and nickel in biological samples using a flow injection system with on-line preconcentration by co-precipitation without filtration. *Appl Spectrosc* 45(9):1433-1443.
- Welz B, Yin X, Sperling M. 1992. Time-based and volume-based sampling for flow-injection on-line sorbent extraction graphite furnace atomic absorption spectrometry. *Anal Chim Acta* 261:477-487.
- West JR, Smith HW, Chasis H. 1948. Glomerular filtration rate, effective renal blood flow, and maximal tubular excretory capacity in infancy. *J Pediatr* 32:10-18.
- Wester RC, Maibach HI, Sedik L, et al. 1992. *In vitro* percutaneous absorption of cadmium from water and soil into human skin. *Fundam Appl Toxicol* 19:1-5.
- Whanger PD. 1992. Selenium in the treatment of heavy metal poisoning and chemical carcinogenesis. *J Trace Elem Electrolytes Health Dis* 6:209-221.
- Whelton BD, Bhattacharyya MH, Carnes BA, et al. 1988. Female reproduction and pup survival and growth for mice fed a cadmium-containing purified diet through six consecutive rounds of gestation and lactation. *J Toxicol Environ Health* 24:321-343.
- WHO. 2000. Air quality guidelines. 2nd ed. Geneva, Switzerland: World Health Organization. <http://www.euro.who.int/Document/AIQ/AirQualRepMtg.pdf>. March 08, 2006.
- WHO. 2004. Guidelines for drinking-water quality. Vol. 1. Recommendations. 3rd ed. Geneva, Switzerland: World Health Organization. http://www.who.int/water_sanitation_health/dwq/gdwq3/en/. March 08, 2006.
- Widdowson EM, Dickerson JWT. 1964. Chemical composition of the body. In: Comar CL, Bronner F, eds. Mineral metabolism: An advanced treatise. Vol. II: The elements Part A. New York, NY: Academic Press, 1-247.
- Wilber GG, Smith L, Malanchuk JL. 1992. Emissions inventory of heavy metals and hydrophobic organics in the Great Lakes basin. In: Schnoor JL, ed. Fate of pesticides and chemicals in the environment. John Wiley and Sons, Inc., 27-50.
- Wilhelm M, Eberwein G, Holzer J, et al. 2005. Human biomonitoring of cadmium and lead exposure of child-mother pairs from Germany living in the vicinity of industrial sources (Hot Spot Study NRW). *J Trace Elem Med Biol* 19:83-90.
- Wilhelm M, Ohnesorge FK, Hotzel D. 1990. Cadmium, copper, lead, and zinc concentrations in human scalp and pubic hair. *Sci Total Environ* 92:199-206.
- Wills JH, Groblewski GE, Coulston F. 1981. Chronic and multigeneration toxicities of small concentrations of cadmium in the diet of rats. *Ecotoxicol Environ Saf* 5:452-464.

9. REFERENCES

- Wilson RH, DeEds F, Cox AJ. 1941. Effects of continued cadmium feeding. *J Pharmacol Exp Ther* 71:222-235.
- Wisniewska-Knypl JM, Jablonska J, Myslak Z. 1971. Binding of cadmium on metallothionein in man: An analysis of a fatal poisoning by cadmium iodide. *Arch Toxicol* 28:46-55.
- Woittiez JRW, Tangonan MD. 1992. Determination of Cd, Mo, Cr, and Co in biological materials by RNAA. *J Radioanal Nucl Chem* 158(2):313-321.
- Wong KL, Klaassen CD. 1980a. Tissue distribution and retention of cadmium in rats during postnatal development: minimal role of hepatic metallothionein. *Toxicol Appl Pharmacol* 53:343-353.
- *Wong KL, Klaassen CD. 1980b. Age difference in the susceptibility to cadmium-induced testicular damage in rats. *Toxicol Appl Pharmacol* 55:456-466.
- Wong KL, Klaassen CD. 1982. Neurotoxic effect of cadmium in young rats. *Toxicol Appl Pharmacol* 63:330-337.
- Wong PK. 1988. Mutagenicity of heavy metals. *Bull Environ Contam Toxicol* 40(4):597-603.
- Wronska-Nofer T, Wisniewska-Knypl J, Wyszynska K. 1999. Prooxidative and genotoxic effect of transition metals (cadmium, nickel, chromium, and vanadium) in mice. *Trace Elem Electrolytes* 15(2):87-92.
- Wu Q, Magnus JH, Hentz JG. 2010. Urinary cadmium, osteopenia, and osteoporosis in the US population. *Osteoporos Int* 21(8):1449-1454.
- Wu X, Jin T, Wang Z, et al. 2001. Urinary calcium as a biomarker of renal dysfunction in a general population exposed to cadmium. *J Occup Environ Med* 43(10):898-904.
- Wu X, Liang Y, Jin T, et al. 2008. Renal effects evolution in a Chinese population after reduction of cadmium exposure in rice. *Environ Res* 108(2):233-238.
- Xu B, Chia SE, Tsakok M, et al. 1993a. Trace elements blood and seminal plasma and their relationship to sperm quality. *Reprod Toxicol* 7:613-618.
- Xu B, Jin Y, Fen Z, et al. 1993b. Lipid peroxidation induced by maternal cadmium exposure in mouse pups. *Bull Environ Contam Toxicol* 51:772-779.
- Xu C, Holscher MA, Jones MM, et al. 1995. Effect of monoisoamyl meso-2,3-dimercaptosuccinate on the pathology of acute cadmium intoxication. *J Toxicol Environ Health* 45:261-277.
- Xu C, Johnson JE, Singh PK, et al. 1996. *In vivo* studies of cadmium-induced apoptosis in testicular tissue of the rat and its modulation by a chelating agent. *Toxicology* 107:1-8.
- Xue H, Sigg L, Gachter R. 2000. Transport of Cu, Zn and Cd in a small agricultural catchment. *Water Res* 34(9):2558-2568.
- Yamanaka O, Kobayashi EN K, Suwazono Y, et al. 1998. Association between renal effects and cadmium exposure in cadmium-nonpolluted area in Japan. *Environ Res* 77(Sect A):1-8.

9. REFERENCES

- Yamane Y, Fukuchi M, Li CK, et al. 1990. Protective effect of sodium molybdate against the acute toxicity of cadmium chloride. *Toxicology* 60:235-243.
- Yokota H, Tonami H. 2008. Experimental studies on the bone metabolism of male rats chronically exposed to cadmium intoxication using dual-energy X-ray absorptiometry. *Toxicol Ind Health* 24(3):161-170.
- Zeng X, Jin T, Buchet JP, et al. 2004a. Impact of cadmium exposure on male sex hormones: A population-based study in China. *Environ Res* 2004:338-344.
- Zeng X, Jin T, Jiang X, et al. 2004b. Effects on the prostate of environmental cadmium exposure—a cross-sectional population study in China. *Biomaterials* 17(5):559-565.
- Zenick H, Hastings L, Goldsmith M, et al. 1982. Chronic cadmium exposure: Relation to male reproductive toxicity and subsequent fetal outcome. *J Toxicol Environ Health* 9:377-387.
- Zhang YL, Zhao YC, Wang JX, et al. 2004. Effect of environmental exposure to cadmium on pregnancy outcome and fetal growth: A study on healthy pregnant women in China. *J Environ Sci Health A* 39(9):2507-2515.
- Zhang ZQ, Chen SZ, Lin HM, et al. 1993. Simultaneous determination of copper, nickel, lead, cobalt and cadmium by adsorptive voltammetry. *Anal Chim Acta* 272:227-232.
- *Zhou D, Zhang L, Zhou J, et al. 2004a. Cellulose/chitin beads for adsorption of heavy metals in aqueous solution. *Water Res* 38:2643-2650.
- Zhou T, Jia X, Chapin RE, et al. 2004b. Cadmium at a non-toxic dose alters gene expression in mouse testes. *Toxicol Lett* 154(3):191-200.
- Zhu G, Wang H, Shi Y, et al. 2004. Environmental cadmium exposure and forearm bone density. *Biomaterials* 17:499-503.
- Ziegler EE, Edwards BB, Jensen RL, et al. 1978. Absorption and retention of lead by infants. *Pediatr Res* 12(1):29-34.

10. GLOSSARY

Absorption—The taking up of liquids by solids, or of gases by solids or liquids.

Acute Exposure—Exposure to a chemical for a duration of 14 days or less, as specified in the Toxicological Profiles.

Adsorption—The adhesion in an extremely thin layer of molecules (as of gases, solutes, or liquids) to the surfaces of solid bodies or liquids with which they are in contact.

Adsorption Coefficient (K_{oc})—The ratio of the amount of a chemical adsorbed per unit weight of organic carbon in the soil or sediment to the concentration of the chemical in solution at equilibrium.

Adsorption Ratio (K_d)—The amount of a chemical adsorbed by sediment or soil (i.e., the solid phase) divided by the amount of chemical in the solution phase, which is in equilibrium with the solid phase, at a fixed solid/solution ratio. It is generally expressed in micrograms of chemical sorbed per gram of soil or sediment.

Benchmark Dose (BMD)—Usually defined as the lower confidence limit on the dose that produces a specified magnitude of changes in a specified adverse response. For example, a BMD_{10} would be the dose at the 95% lower confidence limit on a 10% response, and the benchmark response (BMR) would be 10%. The BMD is determined by modeling the dose response curve in the region of the dose response relationship where biologically observable data are feasible.

Benchmark Dose Model—A statistical dose-response model applied to either experimental toxicological or epidemiological data to calculate a BMD.

Bioconcentration Factor (BCF)—The quotient of the concentration of a chemical in aquatic organisms at a specific time or during a discrete time period of exposure divided by the concentration in the surrounding water at the same time or during the same period.

Biomarkers—Broadly defined as indicators signaling events in biologic systems or samples. They have been classified as markers of exposure, markers of effect, and markers of susceptibility.

Cancer Effect Level (CEL)—The lowest dose of chemical in a study, or group of studies, that produces significant increases in the incidence of cancer (or tumors) between the exposed population and its appropriate control.

Carcinogen—A chemical capable of inducing cancer.

Case-Control Study—A type of epidemiological study that examines the relationship between a particular outcome (disease or condition) and a variety of potential causative agents (such as toxic chemicals). In a case-controlled study, a group of people with a specified and well-defined outcome is identified and compared to a similar group of people without outcome.

Case Report—Describes a single individual with a particular disease or exposure. These may suggest some potential topics for scientific research, but are not actual research studies.

Case Series—Describes the experience of a small number of individuals with the same disease or exposure. These may suggest potential topics for scientific research, but are not actual research studies.

10. GLOSSARY

Ceiling Value—A concentration of a substance that should not be exceeded, even instantaneously.

Chronic Exposure—Exposure to a chemical for 365 days or more, as specified in the Toxicological Profiles.

Cohort Study—A type of epidemiological study of a specific group or groups of people who have had a common insult (e.g., exposure to an agent suspected of causing disease or a common disease) and are followed forward from exposure to outcome. At least one exposed group is compared to one unexposed group.

Cross-sectional Study—A type of epidemiological study of a group or groups of people that examines the relationship between exposure and outcome to a chemical or to chemicals at one point in time.

Data Needs—Substance-specific informational needs that if met would reduce the uncertainties of human health assessment.

Developmental Toxicity—The occurrence of adverse effects on the developing organism that may result from exposure to a chemical prior to conception (either parent), during prenatal development, or postnatally to the time of sexual maturation. Adverse developmental effects may be detected at any point in the life span of the organism.

Dose-Response Relationship—The quantitative relationship between the amount of exposure to a toxicant and the incidence of the adverse effects.

Embryotoxicity and Fetotoxicity—Any toxic effect on the conceptus as a result of prenatal exposure to a chemical; the distinguishing feature between the two terms is the stage of development during which the insult occurs. The terms, as used here, include malformations and variations, altered growth, and *in utero* death.

Environmental Protection Agency (EPA) Health Advisory—An estimate of acceptable drinking water levels for a chemical substance based on health effects information. A health advisory is not a legally enforceable federal standard, but serves as technical guidance to assist federal, state, and local officials.

Epidemiology—Refers to the investigation of factors that determine the frequency and distribution of disease or other health-related conditions within a defined human population during a specified period.

Genotoxicity—A specific adverse effect on the genome of living cells that, upon the duplication of affected cells, can be expressed as a mutagenic, clastogenic, or carcinogenic event because of specific alteration of the molecular structure of the genome.

Half-life—A measure of rate for the time required to eliminate one half of a quantity of a chemical from the body or environmental media.

Immediately Dangerous to Life or Health (IDLH)—The maximum environmental concentration of a contaminant from which one could escape within 30 minutes without any escape-impairing symptoms or irreversible health effects.

Immunologic Toxicity—The occurrence of adverse effects on the immune system that may result from exposure to environmental agents such as chemicals.

10. GLOSSARY

Immunological Effects—Functional changes in the immune response.

Incidence—The ratio of individuals in a population who develop a specified condition to the total number of individuals in that population who could have developed that condition in a specified time period.

Intermediate Exposure—Exposure to a chemical for a duration of 15–364 days, as specified in the Toxicological Profiles.

In Vitro—Isolated from the living organism and artificially maintained, as in a test tube.

In Vivo—Occurring within the living organism.

Lethal Concentration_(LO) (LC_{LO})—The lowest concentration of a chemical in air that has been reported to have caused death in humans or animals.

Lethal Concentration₍₅₀₎ (LC₅₀)—A calculated concentration of a chemical in air to which exposure for a specific length of time is expected to cause death in 50% of a defined experimental animal population.

Lethal Dose_(LO) (LD_{LO})—The lowest dose of a chemical introduced by a route other than inhalation that has been reported to have caused death in humans or animals.

Lethal Dose₍₅₀₎ (LD₅₀)—The dose of a chemical that has been calculated to cause death in 50% of a defined experimental animal population.

Lethal Time₍₅₀₎ (LT₅₀)—A calculated period of time within which a specific concentration of a chemical is expected to cause death in 50% of a defined experimental animal population.

Lowest-Observed-Adverse-Effect Level (LOAEL)—The lowest exposure level of chemical in a study, or group of studies, that produces statistically or biologically significant increases in frequency or severity of adverse effects between the exposed population and its appropriate control.

Lymphoreticular Effects—Represent morphological effects involving lymphatic tissues such as the lymph nodes, spleen, and thymus.

Malformations—Permanent structural changes that may adversely affect survival, development, or function.

Minimal Risk Level (MRL)—An estimate of daily human exposure to a hazardous substance that is likely to be without an appreciable risk of adverse noncancer health effects over a specified route and duration of exposure.

Modifying Factor (MF)—A value (greater than zero) that is applied to the derivation of a Minimal Risk Level (MRL) to reflect additional concerns about the database that are not covered by the uncertainty factors. The default value for a MF is 1.

Morbidity—State of being diseased; morbidity rate is the incidence or prevalence of disease in a specific population.

Mortality—Death; mortality rate is a measure of the number of deaths in a population during a specified interval of time.

10. GLOSSARY

Mutagen—A substance that causes mutations. A mutation is a change in the DNA sequence of a cell's DNA. Mutations can lead to birth defects, miscarriages, or cancer.

Necropsy—The gross examination of the organs and tissues of a dead body to determine the cause of death or pathological conditions.

Neurotoxicity—The occurrence of adverse effects on the nervous system following exposure to a chemical.

No-Observed-Adverse-Effect Level (NOAEL)—The dose of a chemical at which there were no statistically or biologically significant increases in frequency or severity of adverse effects seen between the exposed population and its appropriate control. Effects may be produced at this dose, but they are not considered to be adverse.

Octanol-Water Partition Coefficient (K_{ow})—The equilibrium ratio of the concentrations of a chemical in *n*-octanol and water, in dilute solution.

Odds Ratio (OR)—A means of measuring the association between an exposure (such as toxic substances and a disease or condition) that represents the best estimate of relative risk (risk as a ratio of the incidence among subjects exposed to a particular risk factor divided by the incidence among subjects who were not exposed to the risk factor). An OR of greater than 1 is considered to indicate greater risk of disease in the exposed group compared to the unexposed group.

Organophosphate or Organophosphorus Compound—A phosphorus-containing organic compound and especially a pesticide that acts by inhibiting cholinesterase.

Permissible Exposure Limit (PEL)—An Occupational Safety and Health Administration (OSHA) allowable exposure level in workplace air averaged over an 8-hour shift of a 40-hour workweek.

Pesticide—General classification of chemicals specifically developed and produced for use in the control of agricultural and public health pests.

Pharmacokinetics—The dynamic behavior of a material in the body, used to predict the fate (disposition) of an exogenous substance in an organism. Utilizing computational techniques, it provides the means of studying the absorption, distribution, metabolism, and excretion of chemicals by the body.

Pharmacokinetic Model—A set of equations that can be used to describe the time course of a parent chemical or metabolite in an animal system. There are two types of pharmacokinetic models: data-based and physiologically-based. A data-based model divides the animal system into a series of compartments, which, in general, do not represent real, identifiable anatomic regions of the body, whereas the physiologically-based model compartments represent real anatomic regions of the body.

Physiologically Based Pharmacodynamic (PBPD) Model—A type of physiologically based dose-response model that quantitatively describes the relationship between target tissue dose and toxic end points. These models advance the importance of physiologically based models in that they clearly describe the biological effect (response) produced by the system following exposure to an exogenous substance.

Physiologically Based Pharmacokinetic (PBPK) Model—Comprised of a series of compartments representing organs or tissue groups with realistic weights and blood flows. These models require a

10. GLOSSARY

variety of physiological information: tissue volumes, blood flow rates to tissues, cardiac output, alveolar ventilation rates, and possibly membrane permeabilities. The models also utilize biochemical information, such as air/blood partition coefficients, and metabolic parameters. PBPK models are also called biologically based tissue dosimetry models.

Prevalence—The number of cases of a disease or condition in a population at one point in time.

Prospective Study—A type of cohort study in which the pertinent observations are made on events occurring after the start of the study. A group is followed over time.

q_1^* —The upper-bound estimate of the low-dose slope of the dose-response curve as determined by the multistage procedure. The q_1^* can be used to calculate an estimate of carcinogenic potency, the incremental excess cancer risk per unit of exposure (usually $\mu\text{g/L}$ for water, mg/kg/day for food, and $\mu\text{g/m}^3$ for air).

Recommended Exposure Limit (REL)—A National Institute for Occupational Safety and Health (NIOSH) time-weighted average (TWA) concentration for up to a 10-hour workday during a 40-hour workweek.

Reference Concentration (RfC)—An estimate (with uncertainty spanning perhaps an order of magnitude) of a continuous inhalation exposure to the human population (including sensitive subgroups) that is likely to be without an appreciable risk of deleterious noncancer health effects during a lifetime. The inhalation reference concentration is for continuous inhalation exposures and is appropriately expressed in units of mg/m^3 or ppm.

Reference Dose (RfD)—An estimate (with uncertainty spanning perhaps an order of magnitude) of the daily exposure of the human population to a potential hazard that is likely to be without risk of deleterious effects during a lifetime. The RfD is operationally derived from the no-observed-adverse-effect level (NOAEL, from animal and human studies) by a consistent application of uncertainty factors that reflect various types of data used to estimate RfDs and an additional modifying factor, which is based on a professional judgment of the entire database on the chemical. The RfDs are not applicable to nonthreshold effects such as cancer.

Reportable Quantity (RQ)—The quantity of a hazardous substance that is considered reportable under the Comprehensive Environmental Response, Compensation, and Liability Act (CERCLA). Reportable quantities are (1) 1 pound or greater or (2) for selected substances, an amount established by regulation either under CERCLA or under Section 311 of the Clean Water Act. Quantities are measured over a 24-hour period.

Reproductive Toxicity—The occurrence of adverse effects on the reproductive system that may result from exposure to a chemical. The toxicity may be directed to the reproductive organs and/or the related endocrine system. The manifestation of such toxicity may be noted as alterations in sexual behavior, fertility, pregnancy outcomes, or modifications in other functions that are dependent on the integrity of this system.

Retrospective Study—A type of cohort study based on a group of persons known to have been exposed at some time in the past. Data are collected from routinely recorded events, up to the time the study is undertaken. Retrospective studies are limited to causal factors that can be ascertained from existing records and/or examining survivors of the cohort.

Risk—The possibility or chance that some adverse effect will result from a given exposure to a chemical.

10. GLOSSARY

Risk Factor—An aspect of personal behavior or lifestyle, an environmental exposure, or an inborn or inherited characteristic that is associated with an increased occurrence of disease or other health-related event or condition.

Risk Ratio—The ratio of the risk among persons with specific risk factors compared to the risk among persons without risk factors. A risk ratio greater than 1 indicates greater risk of disease in the exposed group compared to the unexposed group.

Short-Term Exposure Limit (STEL)—The American Conference of Governmental Industrial Hygienists (ACGIH) maximum concentration to which workers can be exposed for up to 15 minutes continually. No more than four excursions are allowed per day, and there must be at least 60 minutes between exposure periods. The daily Threshold Limit Value-Time Weighted Average (TLV-TWA) may not be exceeded.

Standardized Mortality Ratio (SMR)—A ratio of the observed number of deaths and the expected number of deaths in a specific standard population.

Target Organ Toxicity—This term covers a broad range of adverse effects on target organs or physiological systems (e.g., renal, cardiovascular) extending from those arising through a single limited exposure to those assumed over a lifetime of exposure to a chemical.

Teratogen—A chemical that causes structural defects that affect the development of an organism.

Threshold Limit Value (TLV)—An American Conference of Governmental Industrial Hygienists (ACGIH) concentration of a substance to which most workers can be exposed without adverse effect. The TLV may be expressed as a Time Weighted Average (TWA), as a Short-Term Exposure Limit (STEL), or as a ceiling limit (CL).

Time-Weighted Average (TWA)—An allowable exposure concentration averaged over a normal 8-hour workday or 40-hour workweek.

Toxic Dose₍₅₀₎ (TD₅₀)—A calculated dose of a chemical, introduced by a route other than inhalation, which is expected to cause a specific toxic effect in 50% of a defined experimental animal population.

Toxicokinetic—The absorption, distribution, and elimination of toxic compounds in the living organism.

Uncertainty Factor (UF)—A factor used in operationally deriving the Minimal Risk Level (MRL) or Reference Dose (RfD) or Reference Concentration (RfC) from experimental data. UFs are intended to account for (1) the variation in sensitivity among the members of the human population, (2) the uncertainty in extrapolating animal data to the case of human, (3) the uncertainty in extrapolating from data obtained in a study that is of less than lifetime exposure, and (4) the uncertainty in using lowest-observed-adverse-effect level (LOAEL) data rather than no-observed-adverse-effect level (NOAEL) data. A default for each individual UF is 10; if complete certainty in data exists, a value of 1 can be used; however, a reduced UF of 3 may be used on a case-by-case basis, 3 being the approximate logarithmic average of 10 and 1.

Xenobiotic—Any chemical that is foreign to the biological system.

APPENDIX A. ATSDR MINIMAL RISK LEVELS AND WORKSHEETS

The Comprehensive Environmental Response, Compensation, and Liability Act (CERCLA) [42 U.S.C. 9601 et seq.], as amended by the Superfund Amendments and Reauthorization Act (SARA) [Pub. L. 99–499], requires that the Agency for Toxic Substances and Disease Registry (ATSDR) develop jointly with the U.S. Environmental Protection Agency (EPA), in order of priority, a list of hazardous substances most commonly found at facilities on the CERCLA National Priorities List (NPL); prepare toxicological profiles for each substance included on the priority list of hazardous substances; and assure the initiation of a research program to fill identified data needs associated with the substances.

The toxicological profiles include an examination, summary, and interpretation of available toxicological information and epidemiologic evaluations of a hazardous substance. During the development of toxicological profiles, Minimal Risk Levels (MRLs) are derived when reliable and sufficient data exist to identify the target organ(s) of effect or the most sensitive health effect(s) for a specific duration for a given route of exposure. An MRL is an estimate of the daily human exposure to a hazardous substance that is likely to be without appreciable risk of adverse noncancer health effects over a specified duration of exposure. MRLs are based on noncancer health effects only and are not based on a consideration of cancer effects. These substance-specific estimates, which are intended to serve as screening levels, are used by ATSDR health assessors to identify contaminants and potential health effects that may be of concern at hazardous waste sites. It is important to note that MRLs are not intended to define clean-up or action levels.

MRLs are derived for hazardous substances using the no-observed-adverse-effect level/uncertainty factor approach. They are below levels that might cause adverse health effects in the people most sensitive to such chemical-induced effects. MRLs are derived for acute (1–14 days), intermediate (15–364 days), and chronic (365 days and longer) durations and for the oral and inhalation routes of exposure. Currently, MRLs for the dermal route of exposure are not derived because ATSDR has not yet identified a method suitable for this route of exposure. MRLs are generally based on the most sensitive chemical-induced end point considered to be of relevance to humans. Serious health effects (such as irreparable damage to the liver or kidneys, or birth defects) are not used as a basis for establishing MRLs. Exposure to a level above the MRL does not mean that adverse health effects will occur.

MRLs are intended only to serve as a screening tool to help public health professionals decide where to look more closely. They may also be viewed as a mechanism to identify those hazardous waste sites that

APPENDIX A

are not expected to cause adverse health effects. Most MRLs contain a degree of uncertainty because of the lack of precise toxicological information on the people who might be most sensitive (e.g., infants, elderly, nutritionally or immunologically compromised) to the effects of hazardous substances. ATSDR uses a conservative (i.e., protective) approach to address this uncertainty consistent with the public health principle of prevention. Although human data are preferred, MRLs often must be based on animal studies because relevant human studies are lacking. In the absence of evidence to the contrary, ATSDR assumes that humans are more sensitive to the effects of hazardous substance than animals and that certain persons may be particularly sensitive. Thus, the resulting MRL may be as much as 100-fold below levels that have been shown to be nontoxic in laboratory animals.

Proposed MRLs undergo a rigorous review process: Health Effects/MRL Workgroup reviews within the Division of Toxicology and Human Health Sciences (proposed), expert panel peer reviews, and agency-wide MRL Workgroup reviews, with participation from other federal agencies and comments from the public. They are subject to change as new information becomes available concomitant with updating the toxicological profiles. Thus, MRLs in the most recent toxicological profiles supersede previously published levels. For additional information regarding MRLs, please contact the Division of Toxicology and Human Health Sciences (proposed), Agency for Toxic Substances and Disease Registry, 1600 Clifton Road NE, Mailstop F-62, Atlanta, Georgia 30333.

APPENDIX A

MINIMAL RISK LEVEL (MRL) WORKSHEET

Chemical Name: Cadmium
CAS Numbers: 7440-43-9
Date: September, 2012
Profile Status: Post-Public Comment Draft 2
Route: Inhalation Oral
Duration: Acute Intermediate Chronic
Graph Key: 16
Species: Rat

Minimal Risk Level: 0.03 mg/kg/day $\mu\text{g Cd/m}^3$

Reference: NTP. 1995. Cadmium oxide administered by inhalation to F344/N rats and B6C3F1 mice. National Toxicology Program, U.S. Department of Health and Human Services, Research Triangle Park, NC.

Experimental design: Groups of five male and five female F344 rats were exposed to 0, 0.1, 0.3, 1, 3, or 10 mg cadmium oxide/ m^3 (0, 0.088, 0.26, 0.88, 2.6, or 8.8 mg Cd/ m^3) 6.2 hours/day, 5 days/week for 2 weeks. The mean MMAD of the cadmium oxide particles was 1.5 μm with a geometric standard deviation of 1.6–1.8. The animals were observed twice daily and weighed on days 1 and 8, and at termination. Other parameters used to assess toxicity included organ weights (heart, kidney, liver, lungs, spleen, testis, and thymus) and histopathological examination (gross lesions, heart, kidney, liver, lungs, tracheobronchial lymph nodes, and nasal cavity and turbinates).

Effect noted in study and corresponding doses: All rats in the 8.8 mg Cd/ m^3 group died by day 6; no other deaths occurred. A slight decrease in terminal body weights was observed at 2.6 mg Cd/ m^3 ; however, the body weights were within 10% of control weights. Significant increases in relative and absolute lung weights were observed at 0.26 (males only), 0.88, and 2.6 mg Cd/ m^3 . Histological alterations were limited to the respiratory tract and consisted of alveolar histiocytic infiltrate and focal inflammation in alveolar septa in all rats exposed to ≥ 0.088 mg Cd/ m^3 , necrosis of the epithelium lining alveolar ducts in all rats exposed to ≥ 0.26 mg Cd/ m^3 , tracheobronchiolar lymph node inflammation at ≥ 0.88 mg Cd/ m^3 (incidences in the 0, 0.088, 0.26, 0.88, 2.6, and 8.8 mg Cd/ m^3 groups were 0/3, 0/5, 5/5, 5/5, and 3/4 in males and 0/4, 1/5, 1/5, 3/5, 5/5, and 3/5 in females), degeneration of the nasal olfactory epithelium at 0.88 mg Cd/ m^3 (0/5, 0/5, 0/5, 2/5, 5/5, and 5/5 in males and 0/5, 0/5, 0/5, 4/5, 4/5, and 4/4 in females) and inflammation (0/5, 0/5, 0/5, 1/5, 5/5, and 3/5 in males and 0/5, 0/5, 0/5, 0/5, 4/5, and 3/4 in females) and metaplasia (0/5, 0/5, 0/5, 1/5, 0/5, and 5/5 in males and 0/5, 0/5, 0/5, 0/5, 4/5, and 4/4 in females) of the nasal respiratory epithelium at 2.6 mg Cd/ m^3 .

Dose and end point used for MRL derivation: The LOAEL of 0.088 mg Cd/ m^3 was selected as the point of departure for derivation of the MRL; benchmark dose analysis was considered; however, the data were not suitable for benchmark dose analysis because the incidence data for alveolar histiocytic infiltration do not provide sufficient information about the shape of the dose-response relationship below the 100% response level.

NOAEL LOAEL

Uncertainty Factors used in MRL derivation:

10 for use of a LOAEL

3 for extrapolation from animals to humans with dosimetric adjustment

APPENDIX A

[X] 10 for human variability

Was a conversion factor used from ppm in food or water to a mg/body weight dose? No.

If an inhalation study in animals, list conversion factors used in determining human equivalent dose:

The LOAEL_{HEC} was calculated using the equations below.

$$\text{LOAEL}_{\text{HEC}} = \text{LOAEL}_{\text{ADJ}} \times \text{RDDR}$$

The duration-adjusted LOAEL (LOAEL_{ADJ}) was calculated as follows:

$$\begin{aligned} \text{LOAEL}_{\text{ADJ}} &= 0.088 \text{ mg Cd/m}^3 \times 6.2 \text{ hours/24 hours} \times 5 \text{ days/7 days} \\ \text{LOAEL}_{\text{ADJ}} &= 0.016 \text{ mg Cd/m}^3 \end{aligned}$$

The regional deposited dose ratio (RDDR) for the pulmonary region of 0.617 was calculated with EPA's RDDR calculator (EPA 1994a) using the final body weight of 0.194 kg for the male rats exposed 0.088 mg Cd/m³, the reported MMAD of 1.5 μm and the midpoint of the reported range of geometric standard deviations (1.7)

$$\begin{aligned} \text{LOAEL}_{\text{HEC}} &= 0.016 \text{ mg Cd/m}^3 \times 0.617 \\ \text{LOAEL}_{\text{HEC}} &= 0.01 \text{ mg Cd/m}^3 \end{aligned}$$

Was a conversion used from intermittent to continuous exposure? Yes (see above)

Other additional studies or pertinent information that lend support to this MRL: The acute toxicity of airborne cadmium, particularly cadmium oxide fumes, was first recognized in the early 1920s and there have been numerous case reports of cadmium workers dying after brief exposures to presumably high concentrations of cadmium fumes (European Chemicals Bureau 2007). The initial symptoms, similar to those observed in metal fume fever, are usually mild but rapidly progress to severe pulmonary edema and chemical pneumonitis. Persistent respiratory effects (often lasting years after the exposure) have been reported in workers surviving these initial effects. There are limited monitoring data for these human reports; however, Elinder (1986b) estimated that an 8-hour exposure to 1–5 mg/m³ would be immediately dangerous.

Animal studies support the findings in humans that acute exposure to cadmium results in lung damage. Single exposures to approximately 1–10 mg Cd/m³ as cadmium chloride or cadmium oxide resulted in interstitial pneumonitis, diffuse alveolitis with hemorrhage, focal interstitial thickening, and edema (Boudreau et al. 1989; Buckley and Bassett 1987b; Bus et al. 1978; Grose et al. 1987; Hart 1986; Henderson et al. 1979; Palmer et al. 1986). Repeated exposure to 6.1 mg Cd/m³ 1 hour/day for 5, 10, or 15 days resulted in emphysema in rats (Snider et al. 1973). At lower concentrations of 0.4–0.5 mg Cd/m³ as cadmium oxide for 2–3 hours (Buckley and Bassett 1987b; Grose et al. 1987) or 0.17 mg Cd/m³ as cadmium chloride 6 hours/day for 10 days (Klimisch 1993) resulted in mild hypercellularity and increases in lung weight. Alveolar histiocytic infiltration and focal inflammation and minimal fibrosis in alveolar septa were observed in rats exposed to 0.088 mg Cd/m³ as cadmium oxide 6.2 hours/day, 5 days/week for 2 weeks (NTP 1995); in similarly exposed mice, histiocytic infiltration was observed at 0.088 mg Cd/m³ (NTP 1995). At similar concentrations (0.19 or 0.88 mg Cd/m³ as cadmium chloride), decreases in humoral immune response were observed in mice exposed for 1–2 hours (Graham et al. 1978; Krzystyniak et al. 1987). Other effects that have been reported in animals acutely exposed to cadmium include erosion of the stomach, decreased body weight gain, and tremors in rats exposed to 132 mg Cd/m³

APPENDIX A

as cadmium carbonate for 2 hours (Rusch et al. 1986) and weight loss and reduced activity in rats exposed to 112 mg Cd/m³ as cadmium oxide for 2 hours (Rusch et al. 1986).

Agency Contact (Chemical Manager): Obaid Faroon, DVM, Ph.D.

APPENDIX A

MINIMAL RISK LEVEL (MRL) WORKSHEET

Chemical Name: Cadmium
CAS Numbers: 7440-43-9
Date: September, 2012
Profile Status: Post-Public Comment Draft 2
Route: Inhalation Oral
Duration: Acute Intermediate Chronic
Graph Key: 63
Species: Human

Minimal Risk Level: 0.01 mg/kg/day $\mu\text{g Cd/m}^3$

Reference: Buchet JP, Lauwerys R, Roels H, et al. 1990. Renal effects of cadmium body burden of the general population. *Lancet* 336:699-702.

Järup L, Hellstrom L, Alfven T, et al. 2000. Low level exposure to cadmium and early kidney damage: The OSCAR study. *Occup Environ Med* 57(10):668-672.

Suwazono Y, Sand S, Vahter M, et al. 2006. Benchmark dose for cadmium-induced renal effects in humans. *Environ Health Perspect* 114:1072-1076.

Experimental design: As detailed in the chronic oral MRL worksheet, a meta-analysis of select environmental exposure dose-response studies examining the relationship between urinary cadmium and the prevalence of elevated levels of biomarkers of renal function in environmentally exposed populations was conducted; for the inhalation MRL, the meta-analysis also included dose-response data from three occupational exposure studies (Chen et al. 2006a, 2006b; Järup and Elinder 1994; Roels et al. 1993). The meta-analysis was used to establish a point of departure for the urinary cadmium-response relationship and pharmacokinetic models (ICRP 1994; Kjellström and Nordberg 1978) were used to predict cadmium air concentrations.

Dose and end point used for MRL derivation: Analysis of the available environmental exposure studies and occupational exposure studies resulted in an estimation of a urinary cadmium level that would result in a 10% increase in the prevalence of β_2 -microglobulin proteinuria (UCD_{10}). The lowest UCD_{10} (1.34 $\mu\text{g/g}$ creatinine) was estimated from the European environmental exposure studies (Buchet et al. 1990; Järup et al. 2000; Suwazono et al. 2006); the UCD_{10} values from the occupational exposure studies were 7.50 $\mu\text{g/g}$ creatinine for the European cohorts (Järup and Elinder 1994; Roels et al. 1993) and 4.58 $\mu\text{g/g}$ creatinine for the Chinese cohort (Chen et al. 2006a, 2006b). The UCD_{10} from the environmental exposure studies was selected as the basis of the MRL. The 95% lower confidence limit on this value (UCDL_{10}) of 0.5 $\mu\text{g/g}$ creatinine was used as the point of departure for the MRL.

NOAEL LOAEL UCDL_{10}

Deposition and clearance of inhaled cadmium oxide and cadmium sulfide particles were modeled using the ICRP Human Respiratory Tract Model (ICRP 1994). The ICRP model simulates deposition, retention, and absorption of inhaled cadmium particles of specific aerodynamic diameters, when specific parameters for cadmium clearance are used in the model (ICRP 1980). Cadmium-specific parameters represent categories of solubility and dissolution kinetics in the respiratory tract (e.g., slow, S; moderate, M; or fast, F). Cadmium compounds are classified as follows: oxides and hydroxides, S; sulfides, halides and nitrates, M; all other, including chloride salts, F.

APPENDIX A

Inhalation exposures ($\mu\text{g}/\text{m}^3$) to cadmium oxide or cadmium sulfide aerosols having particle diameters of 1, 5, or 10 μg (AMAD) were simulated using the ICRP model. Predicted mass transfers of cadmium from the respiratory tract to the gastrointestinal tract (i.e., mucocilliary transport) and to blood (i.e., absorption) were used as inputs to the gastrointestinal and blood compartments of the Kjellström-Nordberg pharmacokinetic model (1978) to simulate the kidney and urinary cadmium levels that correspond to a given inhalation exposure.

An airborne cadmium concentration of 1.8–2.4 $\mu\text{g}/\text{m}^3$ as cadmium oxide or 1.2–1.4 $\mu\text{g}/\text{m}^3$ as cadmium sulfide would result in a urinary cadmium level of 0.5 $\mu\text{g}/\text{g}$ creatinine, assuming that the air was the only source of cadmium. This assumption is not accurate because the diet is a significant contributor to the cadmium body burden. Thus, inhalation exposures were combined with ingestion intakes to estimate an internal dose in terms of urinary cadmium. The age-weighted average intakes of cadmium in nonsmoking males and females in the United States are 0.35 and 0.30 $\mu\text{g Cd}/\text{kg}/\text{day}$, respectively (0.32 $\mu\text{g}/\text{kg}/\text{day}$ for males and females combined) (Choudhury et al. 2001).

Based on the relationship predicted between chronic inhalation exposures to cadmium sulfide (AMAD=1 μm) and oral intakes that yield the same urinary cadmium level, exposure to an airborne cadmium concentration of 0.1 $\mu\text{g}/\text{m}^3$ and a dietary intake of 0.3 $\mu\text{g}/\text{kg}/\text{day}$ would result in a urinary cadmium level of 0.5 $\mu\text{g}/\text{g}$ creatinine.

Uncertainty Factors and Modifying Factors used in MRL derivation:

- 10 for use of a LOAEL
- 10 for extrapolation from animals to humans with dosimetric adjustment
- 3 for human variability

The uncertainty factor of 3 for human variability was used to account for the possible increased sensitivity of diabetics (Åkesson et al. 2005; Buchet et al. 1990).

- modifying factor of 3

The modifying factor of 3 was used to account for the lack of adequate human data that could be used to compare the relative sensitivities of the respiratory tract and kidneys.

Was a conversion factor used from ppm in food or water to a mg/body weight dose? No.

If an inhalation study in animals, list conversion factors used in determining human equivalent dose: Not applicable.

Was a conversion used from intermittent to continuous exposure? The pharmacokinetic model assumes continuous exposure.

Other additional studies or pertinent information that lend support to this MRL: Numerous studies examining the toxicity of cadmium in workers have identified the respiratory tract and the kidney as sensitive targets of toxicity. A variety of respiratory tract effects have been observed in cadmium workers including respiratory symptoms (e.g., dyspnea, coughing, wheezing), emphysema, and impaired lung function. However, many of these studies did not control for smoking, and thus, the role of cadmium in the induction of these effects is difficult to determine. Impaired lung function was reported in several studies that controlled for smoking (Chan et al. 1988; Cortona et al. 1992; Davison et al. 1988; Smith et al. 1976); other studies have not found significant alterations (Edling et al. 1986). The observed alterations include an increase in residual volume in workers exposed to air concentrations of cadmium

APPENDIX A

fumes ranging from 0.008 (in 1990) to 1.53 mg/m³ (in 1975) (mean urinary cadmium level in the workers was 4.3 µg/L) (Cortona et al. 1992); alterations in several lung function parameters (e.g., forced expiratory volume, transfer factor, transfer coefficient) in workers exposed to 0.034–0.156 mg/m³ (Davison et al. 1988); and decreased force vital capacity in workers exposed to >0.2 mg/m³ (Smith et al. 1976). Additionally, Chan et al. (1988) found significant improvements in several parameters of lung function of workers following reduction or cessation of cadmium exposure.

The renal toxicity of cadmium in workers chronically exposed to high levels of cadmium is well established. Observed effects include tubular proteinuria (increased excretion of low molecular weight proteins), decreased resorption of other solutes (increased excretion of enzymes such as N-acetyl-β-glucosaminidase (NAG), amino acids, glucose, calcium, inorganic phosphate), evidence of increased glomerular permeability (increased excretion of albumin), increased kidney stone formation, and decreased glomerular filtration rate. The earliest sign of cadmium-induced kidney damage is an increase in urinary levels of low molecular weight proteins (particularly, β2-microglobulin, retinol binding protein, and human complex-forming glycoprotein [pHC]) in cadmium workers, as compared to levels found in a reference group of workers or the general population (Bernard et al. 1990; Chen et al. 2006a, 2006b; Chia et al. 1992; Elinder et al. 1985a; Falck et al. 1983; Jakubowski et al. 1987, 1992; Järup and Elinder 1994; Järup et al. 1988; Shaikh et al. 1987; Toffoletto et al. 1992; Verschoor et al. 1987). Significant alterations in the prevalence of low molecular weight proteinuria among cadmium workers has been observed at urinary cadmium levels of 1.5 µg/g creatinine and higher (Chen et al. 2006a; Elinder et al. 1985a; Jakubowski et al. 1987; Järup and Elinder 1994).

Agency Contact (Chemical Manager): Obaid Faroon, DVM, Ph.D.

APPENDIX A

MINIMAL RISK LEVEL (MRL) WORKSHEET

Chemical Name: Cadmium
CAS Numbers: 7440-43-9
Date: September, 2012
Profile Status: Post-Public Comment Draft 2
Route: Inhalation Oral
Duration: Acute Intermediate Chronic
Graph Key: 33
Species: Rat

Minimal Risk Level: 0.5 µg Cd/kg/day ppm

Reference: Brzóska MM, Moniuszko-Jakoniuk J. 2005d. Disorders in bone metabolism of female rats chronically exposed to cadmium. *Toxicol Appl Pharmacol* 202(1):68-83.

Brzóska MM, Majewska K, Moniuszko-Jakoniuk J. 2005a. Bone mineral density, chemical composition and biomechanical properties of the tibia of female rats exposed to cadmium since weaning up to skeletal maturity. *Food Chem Toxicol* 43(10):1507-1519.

Brzóska MM, Majewska K, Moniuszko-Jakoniuk J. 2005c. Weakness in the mechanical properties of the femur of growing female rats exposed to cadmium. *Arch Toxicol* 79(5):277-288.

Experimental design: Groups of 40 3-week-old female Wistar rats were exposed to 0, 1, 5, or 50 mg Cd/L as cadmium chloride in drinking water for 12 months. The investigators noted that cadmium intakes were 0.059–0.219, 0.236–1.005, and 2.247–9.649 mg Cd/kg/day in the 1, 5, and 50 mg/L groups, respectively. Using cadmium intake data presented in a figure, cadmium intakes of 0.2, 0.5, and 4 mg Cd/kg/day were estimated. Bone mineral density, bone mineral concentration, and mineralization area of the lumbar spine, femur and total skeleton (bone mineral density only) were assessed after 3, 6, 9, or 12 months of exposure. The mechanical properties of the femur and tibia were evaluated after 12 months of exposure. Markers for bone resorption (urinary and serum levels of C-terminal cross-linking telopeptide of type I collagen [CTX]) and bone formation (serum osteocalcin, total alkaline phosphatase, and cortical bone and trabecular bone alkaline phosphatase), and serum and urinary levels of calcium were also measured at 3, 6, 9, and 12 months.

Effect noted in study and corresponding doses: No significant alterations in body weight gain or food and water consumption were observed. Significant decreases in total skeletal bone mineral density was observed at ≥ 0.2 mg Cd/kg/day; the decrease was significant after 3 months in the 4 mg Cd/kg/day group, after 6 months in the 0.5 mg Cd/kg/day group, and after 9 months in the 0.2 mg Cd/kg/day group. Significant decreases in whole tibia and diaphysis bone mineral density were observed at ≥ 0.2 mg Cd/kg/day after 12 months of exposure. At 0.2 mg Cd/kg/day, bone mineral density was decreased at the proximal and distal ends of the femur after 6 months of exposure; diaphysis bone mineral density was not affected. At 0.5 mg Cd/kg/day, bone mineral density was decreased at the femur proximal and distal ends after 3 months of exposure and diaphysis bone mineral density after 6 months of exposure. At 4 mg Cd/kg/day decreases in femoral proximal, distal, and diaphysis bone mineral density were decreased after 3 months of exposure. Similarly, bone mineral density was significantly decreased in the lumbar spine in the 0.2 and 0.5 mg Cd/kg/day groups beginning at 6 months and at 3 months in the 4 mg Cd/kg/day group. Significant decreases in the mineralization area were observed in the femur and lumbar spine of rats exposed to 4 mg Cd/kg/day; lumbar spine bone mineral area was also affected at 0.5 mg Cd/kg/day. Significant decreases in tibia weight and length were observed at 4 mg Cd/kg/day. In tests of the mechanical properties of the tibia diaphysis, significant alterations in ultimate load, yield load, and

APPENDIX A

displacement at load were observed at ≥ 0.2 mg Cd/kg/day; work to fracture was also significantly altered at 4 mg Cd/kg/day. In the mechanical properties compression tests of the tibia, significant alterations were observed in ultimate load, ultimate load, and stiffness at 0.2 mg Cd/kg/day; displacement at yield and work to fracture at ≥ 0.5 mg Cd/kg/day; and displacement at ultimate at 4 mg Cd/kg/day. Multiple regression analysis showed that the cadmium-induced weakness in bone mechanical properties of the tibia was primarily due to its effects on bone composition, particularly the non-organic components, organic components, and the ratio of the ash weight to organic weight. The mechanical properties of the femur were strongly influenced by the bone mineral density (at the whole bone and diaphysis). A significant decrease in femur length was observed at 6 months of exposure to ≥ 0.2 mg Cd/kg/day; however, decreases in length were not observed at other time points in the 0.2 or 0.5 mg Cd/kg/day groups. Femur weight was significantly decreased at 4 mg Cd/kg/day. In tests of mechanical properties of the femoral neck and distal, decreases in yield load, ultimate load, displacement at ultimate, work to fracture (neck only), and stiffness (distal only) were observed at ≥ 0.2 mg Cd/kg/day. For the femoral diaphysis, significant alterations were observed for yield load, displacement at yield, and stiffness at ≥ 0.2 mg Cd/kg/day. Significant decreases in osteocalcin concentrations were observed in all cadmium groups during the first 6 months of exposure, but not during the last 6 months. Decreases in total alkaline phosphatase levels at 4 mg Cd/kg/day, trabecular bone alkaline phosphatase at 0.2 mg Cd/kg/day, and cortical bone alkaline phosphatase at 4 mg Cd/kg/day were observed. CTX was decreased at ≥ 0.2 mg Cd/kg/day. Total urinary calcium and fractional excretion of calcium were increased at ≥ 0.2 mg Cd/kg/day.

Dose and end point used for MRL derivation:

[] NOAEL [] LOAEL [X] BMDL_{sd1}

At the lowest dose tested, 0.2 mg Cd/kg/day, a number of skeletal alterations were observed including decreases in bone mineral density in the lumbar spine, femur, and tibia, alterations in the mechanical properties of the femur and tibia, decreases in osteocalcin levels, decreases in trabecular bone alkaline phosphatase, and decreases in CTX. Of these skeletal end points, the decrease in bone mineral density was selected as the critical effect because Brzóska et al. (2005a, 2005c) demonstrated that the bone mineral density was a stronger predictor of femur and tibia strength and the risk of fractures.

Available continuous models in the EPA Benchmark Dose Software (version 1.4.1c) were fit to data (Table A-1) for changes in bone mineral density of the femur and lumbar spine in female rats resulting from exposure to cadmium in the drinking water for 6, 9, or 12 months (Brzóska and Moniuszko-Jakoniuk 2005d). The BMD and the 95% lower confidence limit (BMDL) is an estimate of the doses associated with a change of 1 standard deviation from the control. The model-fitting procedure for continuous data is as follows. The simplest model (linear) is applied to the data while assuming constant variance. If the data are consistent with the assumption of constant variance ($p \geq 0.1$), then the other continuous models (polynomial, power, and Hill models) are applied to the data. Among the models providing adequate fits to the means ($p \geq 0.1$), the one with the lowest Akaike's information criterion (AIC) for the fitted model is selected for BMD derivation. If the test for constant variance is negative, the linear model is run again while applying the power model integrated into the benchmark dose software (BMDS) to account for nonhomogenous variance. If the nonhomogenous variance model provides an adequate fit ($p \geq 0.1$) to the variance data, then the other continuous models are applied to the data. Among the models providing adequate fits to the means ($p \geq 0.1$), the one with the lowest AIC for the fitted model is selected for BMD derivation. If the tests for both constant and non-constant variance are negative, then the data set is considered not to be suitable for BMD modeling.

APPENDIX A

Table A-1. Data Sets for Changes in Mineral Bone Density of the Femur and Lumbar Spine in Female Rats Exposed to Cadmium in Drinking Water for 6, 9, or 12 Months

Dataset ^a	Dose (mg Cd/kg/day)			
	0	0.2	0.5	4
Femur ^b				
6 month	329.7±3.6	317.6±2.7 ^c	308.5±3.4 ^d	303.4±3.4 ^e
9 month	343.8±3.1	328.2±2.9 ^d	322.8±3.0 ^e	310.4±3.4 ^e
12 month	354.3±3.7	338.0±1.9 ^d	330.9±3.1 ^d	318.7±3.4 ^e
Lumbar spine ^b				
6 month	272.0±2.4	263.4±2.6 ^c	258.3±2.7 ^d	249.5±2.9 ^e
9 month	282.4±2.3	271.8±1.6 ^d	267.8±1.8 ^e	259.5±2.7 ^e
12 month	286.1±2.3	275.5±1.9 ^d	269.1±1.9 ^e	257.1±3.0 ^e

^an=10.

^bmean±SE; standard errors were transformed to standard deviations for benchmark dose modeling via a function in the BMD software.

^cSignificantly different ($p \leq 0.05$) from the control group.

^dSignificantly different ($p \leq 0.01$) from the control group.

^eSignificantly different ($p \leq 0.001$) from the control group.

Source: Brzóška and Moniuszko-Jakoniuk 2005d

The potential points of departures derived from the best fitting models for each dataset are summarized in Table A-2.

APPENDIX A

Table A-2. Summary of BMDs and BMDLs From the Best Fitting Models Predicting Changes in Bone Mineral Density in Female Rats After Cadmium Exposure From Drinking Water

Exposure Period (months)	Best-fitting model	Number of doses	BMD _{sd1} ^a (mg Cd/kg/day)	BMDL _{sd1} ^a (mg Cd/kg/day)
Femur				
6	Linear	3	0.24	0.17
9	Hill	4	0.11	0.05
12	Hill	4	0.09	0.05
Lumbar spine				
6	Hill	4	0.19	0.08
9	Hill	4	0.11	0.05
12	Hill	4	0.12	0.07

^aBMDs and BMDLs from continuous data are associated with a 1 standard deviation change from the control.

The BMDL_{sd1} of 0.05 mg Cd/kg/day estimated from the 9-month lumbar spine data set was selected as the point of departure for the MRL. In young female rats, the process of intense bone formation occurs during the first 7 months of life (the first 6 months of exposure in this study); thereafter, the increase in bone mineral density slows. In the lumbar spine of the control group, the changes in bone mineral density at 3–6 months, 6–9 months, and 9–12 months were 15, 4, and 1%, respectively. Thus, the 9-month data may best reflect the effect of cadmium on bone mineral density during the period of rapid skeletal growth. The lumbar spine data was selected over the femur data set because trabecular bone, which is abundant in the spine, appears to be more susceptible to cadmium toxicity than cortical bone.

For the 9-month lumbar spine data set, the simplest model (linear) was applied to the data first to test for a fit for constant variance. The constant variance model did provide an adequate fit (as assessed by the p-value for variance) to the data. The polynomial, power, and Hill models were then fit to the data with constant variance assumed. The Hill model was the only model that provided an adequate fit to the data (as assessed by the p-value for the means) (Table A-3). Using the constant-variance Hill model, the BMD_{sd1} and BMDL_{sd1} are 0.11 mg/kg and 0.05 mg Cd/kg/day, respectively (Figure A-1).

Table A-3. Model Predictions for Changes in Bone Mineral Density of the Lumbar Spine in Female Rats Exposed to Cd in Drinking Water for 9 Months

Model ^a	Variance p-value ^b	p-Value for the means ^b	AIC	BMD _{sd1} (mg Cd/kg/day)	BMDL _{sd1} (mg Cd/kg/day)
Linear ^c	0.36	0.00	211.92	1.93	1.42
Polynomial (1-degree) ^c	0.36	0.00	211.92	1.93	1.42
Polynomial (2-degree) ^c	0.36	0.00	211.92	1.93	1.42
Polynomial (3-degree) ^c	0.36	0.00	211.92	1.93	1.42
Power	0.36	0.00	211.92	1.93	1.42
Hill	0.36	0.60	197.21	0.11	0.05

^aConstant variance assumed for all models.

^bValues <0.1 fail to meet conventional goodness-of-fit criteria.

^cRestriction = non-positive.

AIC = Akaike's Information Criteria; BMD = benchmark dose; BMDL = lower confidence limit (95%) on the benchmark dose; p = p value from the Chi-squared test; Std1 = a 1 standard deviation change from the control.

Source: Brzóska and Moniuszko-Jakoniuk 2005d

Figure A-1. Predicted and Observed Incidence of Changes in Lumbar Spine Bone Mineral Density in Female Rats Exposed to Cadmium in Drinking Water for 9 Months (Brzóska and Moniuszko-Jakoniuk 2005d)*

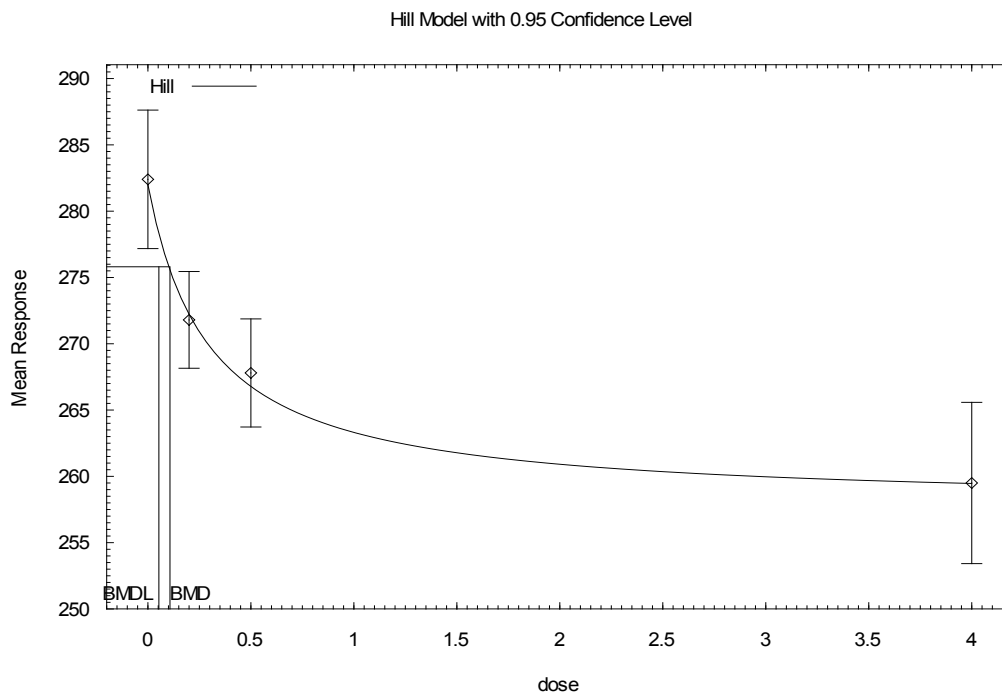

15:24 05/27 2008

*BMDs and BMDLs indicated are associated with a 1 standard deviation change from the control, and are in units of mg Cd/kg/day.

APPENDIX A

Uncertainty Factors used in MRL derivation:

- 10 for use of a LOAEL
- 10 for extrapolation from animals to humans
- 10 for human variability

Was a conversion factor used from ppm in food or water to a mg/body weight dose? Investigators estimated doses based on body weight and water consumption.

If an inhalation study in animals, list conversion factors used in determining human equivalent dose: Not applicable.

Was a conversion used from intermittent to continuous exposure? Not applicable.

Other additional studies or pertinent information that lend support to this MRL: There are limited data on the toxicity of cadmium in humans following intermediate-duration exposure. Numerous animal studies have examined the systemic, immunological, neurological, reproductive, and developmental toxicity of cadmium. The most sensitive systemic effect following intermediate-duration oral exposure to cadmium appears to be damage to growing bone. Exposure to 0.2 mg Cd/kg/day as cadmium chloride in drinking water for 3–12 months resulted decreases in bone mineral density, impaired mechanical strength of the lumbar spine, tibia, and femur bones, increased bone turnover, and increased incidence of deformed or fractured lumbar spine bone in young female rats (3 weeks of age at study initiation) (Brzóška and Moniuszko-Jakoniuk 2005d; Brzóška et al. 2004b, 2005a, 2005b, 2005c, 2010); similar findings were observed in young male rats exposed to 0.5 mg Cd/kg/day for up to 12 months (Brzóška and Moniuszko-Jakoniuk 2005a, 2005b). Decreases in bone strength were also observed in young rats exposed to 0.8 mg Cd/kg/day as cadmium chloride in drinking water for 4 weeks (Ogoshi et al. 1989); however, no skeletal effects were observed in adult or elderly female rats exposed to doses >20 mg Cd/kg/day for 4 weeks (Ogoshi et al. 1989).

Renal effects have been observed at higher doses than the skeletal effects. Vesiculation of the proximal tubules was observed in rats exposed to 1.18 mg Cd/kg/day as cadmium chloride in drinking water for 40 weeks (Gatta et al. 1989). At approximately 3–8 mg Cd/kg/day, proteinuria, tubular necrosis, and decreased renal clearance were observed in rats (Cha 1987; Itokawa et al. 1974; Kawamura et al. 1978; Kotsonis and Klaassen 1978; Prigge 1978a). Liver necrosis and anemia (Cha 1987; Groten et al. 1990; Kawamura et al. 1978) were observed at similar cadmium doses.

A number of developmental effects have been observed in the offspring of rats exposed to cadmium during gestation and lactation. Decreases in glomerular filtration rates and increases in urinary fractional excretion of phosphate, magnesium, potassium, sodium, and calcium were observed in 60-day-old offspring of rats administered via gavage 0.5 mg Cd/kg/day on gestation days 1–21 (Jacquillet et al. 2007). Neurodevelopmental alterations have also been observed at the low maternal doses. Delays in the development of sensory motor coordination reflexes and increased motor activity were observed at 0.706 mg Cd/kg/day (gestation days 1–21) (Ali et al. 1986), decreased motor activity at 0.04 mg Cd/kg/day (5–8 weeks of pre-gestation exposure, gestation days 1–21) (Baranski et al. 1983), decreased ambulation and rearing activity and altered ECG at 14 mg Cd/kg/day (gestation days 5–15, lactation days 2–28, postnatal days 1–56) (Desi et al. 1998) or 7 mg Cd/kg/day (F₂ and F₃ generations) (Nagymajtenyi et al. 1997) have been observed. Decreases in pup body weight were observed at ≥5 mg Cd/kg/day (Baranski 1987; Gupta et al. 1993; Kostial et al. 1993; Pond and Walker 1975) and decreases in fetal body weight or birth weight were observed at ≥2.4 mg Cd/kg/day (Petering et al. 1979; Sorell and Graziano 1990; Webster 1978; Sutou et al. 1980). Another commonly reported developmental effect was alterations in hematocrit levels or anemia in the offspring of animals exposed to ≥1.5 mg Cd/kg/day

APPENDIX A

(Kelman et al. 1978; Baranski 1987; Webster 1978). Increases in the occurrence of malformations or anomalies is limited to a study by Sutou et al. (1980), which reported a significant delay in ossification in rats exposed to 10 mg Cd/kg/day.

The animal studies identify several sensitive targets of toxicity following intermediate-duration exposure to cadmium; these include skeletal mineralization in young female rats exposed for at least 3 months to 0.2 mg Cd/kg/day (Brzóska and Moniuszko-Jakoniuk 2005d; Brzóska et al. 2004b, 2005a, 2005b, 2005c), decreased glomerular filtration in young rats exposed during gestation to maternal doses of 0.5 mg Cd/kg/day (Jacquillet et al. 2007), and neurodevelopmental effects following gestational exposure to 0.04 mg Cd/kg/day (Baranski et al. 1983). Although the Baranski et al. (1983) study reported the lowest LOAEL, it was not selected as the principal study for derivation of an intermediate-duration MRL. For locomotor activity, a significant decrease in activity was observed in female offspring exposed to 0.04, 0.4, and 4 mg Cd/kg/day, as compared to controls; however, no significant differences were found between the cadmium groups despite the 100-fold difference in doses. Locomotor activity was also decreased in males exposed to 0.4 or 4 mg Cd/kg/day. For the rotorod test, a significant decrease in the length of time the rat stayed on the rotorod was observed in males exposed to 0.04 and 0.4 mg Cd/kg/day, but not to 4 mg Cd/kg/day and in females exposed to 0.4 and 4 mg Cd/kg/day; no differences between the cadmium groups were observed in the males and females. The results were poorly reported and the investigators did not explain the lack of dose-response of the effects or the discrepancy between genders.

Agency Contact (Chemical Manager): Obaid Faroon, DVM, Ph.D.

APPENDIX A

MINIMAL RISK LEVEL (MRL) WORKSHEET

Chemical Name: Cadmium
CAS Numbers: 7440-43-9
Date: September, 2012
Profile Status: Post-Public Comment Draft 2
Route: Inhalation Oral
Duration: Acute Intermediate Chronic
Graph Key: 106
Species: Human

Minimal Risk Level: 0.1 $\mu\text{g Cd/kg/day}$ $\mu\text{g Cd/m}^3$

Reference: Buchet JP, Lauwerys R, Roels H, et al. 1990. Renal effects of cadmium body burden of the general population. *Lancet* 336:699-702.

Järup L, Hellstrom L, Alfven T, et al. 2000. Low level exposure to cadmium and early kidney damage: The OSCAR study. *Occup Environ Med* 57(10):668-672.

Suwazono Y, Sand S, Vahter M, et al. 2006. Benchmark dose for cadmium-induced renal effects in humans. *Environ Health Perspect* 114:1072-1076.

Experimental design: ATSDR conducted a meta-analysis of select environmental exposure dose-response studies examining the relationship between urinary cadmium and the prevalence of elevated levels of biomarkers of renal function (Buchet et al. 1990; Järup et al. 2000; Jin et al. 2004c; Kobayashi et al. 2006; Shimizu et al. 2006; Suwazono et al. 2006; Wu et al. 2001). The studies were selected based on the following qualitative criteria: (1) the study measured an urinary cadmium as indicator of internal dose; (2) the study measured reliable indicators of low molecular weight (LMW) proteinuria; (3) a dose-response relationship was reported in sufficient detail so that the dose-response function could be reproduced independently; (4) the study was of reasonable size to have provided statistical strength to the estimates of dose-response model parameters (i.e., most studies selected included several hundred to several thousand subjects); and (5) major co-variables that might affect the dose-response relationship (e.g., age, gender) were measured or constrained by design and included in the dose-response analysis. No attempt was made to weight selected studies for quality, statistical power, or statistical uncertainty in dose-response parameters. Studies using a cut-off value for β_2 -microglobulin of $\geq 1,000 \mu\text{g/g creatinine}$ were eliminated from the analysis based on the conclusions of Bernard et al. (1997) that urinary β_2 -microglobulin levels of 1,000–10,000 $\mu\text{g/g creatinine}$ were indicative of irreversible tubular proteinuria, which may lead to an age-related decline in glomerular filtration rate. Additionally, an attempt was made to avoid using multiple analyses of the same study population.

The individual dose-response functions from each study were implemented to arrive at estimates of the internal dose (urinary cadmium expressed as $\mu\text{g/g creatinine}$) corresponding to probabilities of 10% excess risk of low molecular weight proteinuria (urinary cadmium dose, UCD_{10}). Estimates were derived from the seven environmental exposure studies listed above. When available, male and female data were treated separately; thus, 11 dose-response relationships were analyzed. For studies that did not report the UCD_{10} , the value was estimated by iteration of the reported dose response relationship for varying values of urinary cadmium, until an excess risk of 10% was achieved. For studies that reported the dose-response relationship graphically, but did not report the actual dose-response function, a function was derived by least squares fitting based on data from a digitization of the graphic

APPENDIX A

Dose and end point used for MRL derivation: Aggregate UCD₁₀ estimates and the estimates stratified by location (i.e., Europe, Japan, China) are presented in Table A-4. The lowest UCD₁₀ (1.34 µg/g creatinine) was estimated from the European database; and the 95% lower confidence limit on this UCD₁₀ (UCDL₁₀) of 0.5 µg/g creatinine was considered as the point of departure for the MRL.

Table A-4. Estimates of the UCD₁₀ and Cadmium Intake from Environmental Exposure Dose-Response Studies

	UCD ₁₀ ^a (µg Cd/g creatinine)	Cadmium intake ^b (µg/kg/day)	
		Females	Males
Europe (n=4) ^c			
Mean	1.34	0.97	2.24
Median	—	—	—
95% CI	0.50, 2.18	0.33, 1.75	0.70, 3.94
Japan (n=4) ^d			
Mean	5.23	4.59	10.1
Median	—	—	—
95% CI	4.24, 6.21	3.67, 5.49	8.07, 12.0
China (n=3) ^e			
Mean	9.55	8.60	18.8
Median	—	—	—
95% CI	2.96, 16.1	2.48, 14.7	5.51, 31.9
All (n=11)			
Mean	4.99	4.37	9.58
Median	4.20	3.63	7.99
95% CI	1.44, 6.60	1.06, 5.86	2.45, 12.8

^aEstimates of urinary cadmium level corresponding to probabilities of 10% excess risk of low molecular weight proteinuria (UCD₁₀).

^bUCD was transformed into estimates of chronic cadmium intake that would result in the UCD at age 55 using a modification (Choudhury et al. 2001; Diamond et al. 2003) of the Kjellström and Nordberg (1978) model.

^cDose-response function data from Buchet et al. (1990), Suwazono et al. (2006), and Järup et al. (2000); dose response data from males and females in the Buchet et al. (1990) study were treated separately.

^dDose-response function data from Kobayashi et al. (2006) and Shimizu et al. (2006); dose response data from males and females were treated separately.

^eDose-response function data from Jin et al. (2004c) and Wu et al. (2001); dose response data from males and females in the Jin et al. (2004c) study were treated separately.

UCD = urinary cadmium dose

NOAEL LOAEL UCDL₁₀

The UCDL₁₀ of 0.5 µg/g creatinine was transformed into estimates of chronic cadmium intake (expressed as µg/kg/day) that would result in the UCDL₁₀ at age 55 (approximate age of peak cadmium concentration in the renal cortex associated with a constant chronic intake). The dose transformations were achieved by simulation using a modification of the Kjellström and Nordberg (1978) model. The following modifications (Choudhury et al. 2001; Diamond et al. 2003) were made to the model: (1) the equations describing intercompartmental transfers of cadmium were implemented as differential equations in Advanced Computer Simulation Language (acslXtreme, version 2.4.0.9); (2) growth algorithms for males

APPENDIX A

and females and corresponding organ weights (O'Flaherty 1993) were used to calculate age-specific cadmium concentrations from tissue cadmium masses; (3) the cadmium concentration in renal cortex (RC, $\mu\text{g/g}$) was calculated as follows:

$$RC = 1.5 \cdot \frac{K}{KW}$$

where K is the age-specific renal cadmium burden (μg) and KW is the age-specific kidney wet weight (g) (Friberg et al. 1974)

(4) the rate of creatinine excretion (e.g., $C_{r_{ur}}$, g creatinine/day) was calculated from the relationship between lean body mass (LBM) and $C_{r_{ur}}$; and (5) absorption of ingested cadmium was assumed to be 5% in males and 10% in females. The rate of creatinine excretion (e.g., $C_{r_{ur}}$, g creatinine/day) was estimated from the relationship between LBM (kg) and $C_{r_{ur}}$:

$$LBM = 27.2 \cdot C_{r_{ur}} + 8.58$$

where the constants 27.2 and 8.58 are the sample size-weighted arithmetic mean of estimates of these variables from eight studies reported in (Forbes and Bruining 1976). Lean body mass was estimated as follows (ICRP 1981):

$$LBM = BW \cdot 0.85, \text{adult females}$$

$$LBM = BW \cdot 0.88, \text{adult males}$$

where the central tendency for adult body weight for males and females were assumed to be 70 and 58 kg for adult European/American males and females, respectively.

Dose units expressed as cadmium intake ($\mu\text{g/kg/day}$), urinary cadmium excretion ($\mu\text{g/g}$ creatinine), or kidney tissue cadmium ($\mu\text{g/g}$ cortex) were interconverted by iterative pharmacokinetic model simulations of constant intakes for the life-time to age 55 years, the age at which renal cortex cadmium concentrations are predicted to reach their peak when the rate of intake ($\mu\text{g/kg/day}$) is constant.

The dietary cadmium intakes which would result in urinary cadmium levels of 1.34 and 0.5 $\mu\text{g/g}$ creatinine (UCD_{10} and $UCDL_{10}$) are 0.97 and 0.33 $\mu\text{g/kg/day}$ in females and 2.24 and 0.70 $\mu\text{g/kg/day}$ in males.

Uncertainty Factors used in MRL derivation:

- 10 for use of a LOAEL
- 10 for extrapolation from animals to humans
- 3 for human variability

The UCD is based on several large-scale environmental exposure studies that likely included sensitive subpopulations; however, there is concern that individuals with diabetes may be especially sensitive to the renal toxicity of cadmium (Åkesson et al. 2005; Buchet et al. 1990) and diabetics were excluded from a number of human studies, and thus, an uncertainty factor of 3 was used.

Was a conversion factor used from ppm in food or water to a mg/body weight dose? No.

APPENDIX A

If an inhalation study in animals, list conversion factors used in determining human equivalent dose: Not applicable.

Was a conversion used from intermittent to continuous exposure? No.

Other additional studies or pertinent information that lend support to this MRL: The results of numerous studies of environmentally exposed populations provide strong evidence that the kidney, and possibly bone, is the most sensitive target of toxicity following chronic exposure to cadmium. Most of the studies have focused on subclinical alterations of kidney function, as measured by the urinary excretion of several biomarkers including low molecular weight proteins (β 2-microglobulin, pH₂C, retinol binding protein), intracellular tubular enzymes (NAG), amino acids, high molecular weight proteins (albumin), and electrolytes (potassium, sodium, calcium). Significant associations between urinary cadmium levels and an increased prevalence of abnormal levels of these biomarkers have been found in populations living in areas with moderate or high cadmium pollution or low cadmium pollution (Bandara et al. 2010; Buchet et al. 1990; Cai et al. 1990, 1992, 1998, 2001; Ferraro et al. 2010; Hayano et al. 1996; Honda et al. 2010; Horiguchi et al. 2004, 2010; Hwangbo et al. 2011; Ishizaki et al. 1989; Izuno et al. 2000; Järup et al. 2000; Jin et al. 2002, 2004a, 2004c; Kawada et al. 1992; Kido and Nogawa 1993; Kobayashi et al. 2002a, 2009b; Monzawa et al. 1998; Nakashima et al. 1997; Nogawa et al. 1989; Noonan et al. 2002; Nordberg et al. 1997; Olsson et al. 2002; Oo et al. 2000; Osawa et al. 2001; Roels et al. 1981b; Suwazono et al. 2006; Teeyakasem et al. 2007; Trzcinka-Ochocka et al. 2004; Uno et al. 2005; Yamanaka et al. 1998; Wu et al. 2001). Increases in the prevalence of abnormal biomarker levels appear to be the most sensitive indicator of cadmium toxicity and alterations have been observed at urinary cadmium levels ranging from 1 μ g/g creatinine (Järup et al. 2000) to 9.51 μ g/g creatinine (Jin et al. 2004a).

Several studies have examined the possible association between exposure to cadmium and bone effects. Significant associations between urinary cadmium levels and an increased risk of bone fractures at urinary cadmium levels of ≥ 0.7 μ g/g creatinine (Alfvén et al. 2004; Staessen et al. 1999; Wang et al. 2003), increased risk of osteoporosis at urinary cadmium levels of ≥ 1.5 μ g/g creatinine (Alfvén et al. 2000; Jin et al. 2004b; Wang et al. 2003), and decreased bone mineral density at urinary cadmium levels of ≥ 0.6 μ g/g creatinine (Engström et al. 2009; Nordberg et al. 2002; Schutte et al. 2008; Trzcinka-Ochocka et al. 2010).

The adverse effect levels for renal effects were similar to those observed for skeletal effects. Because the renal effects database is stronger, it was used for derivation of a chronic-duration oral MRL for cadmium. Three approaches were considered for derivation of the MRL: (1) NOAEL/LOAEL approach using a single environmental exposure study finding an increased prevalence of abnormal renal effect biomarker levels, (2) selection of a point of departure from a published benchmark dose analysis, or (3) selection of a point of departure on an analysis of the dose-response functions from a number of environmental exposure studies.

In the first approach, all studies in which individual internal doses for subjects were estimated based on urinary cadmium were considered. The Järup et al. (2000) study identified the lowest adverse effect level; the investigators estimated that a urinary cadmium level of 1 μ g/g creatinine would be associated with a 10% increase in the prevalence of abnormal pH₂C levels above background prevalence (approximately a 10% added risk). The European Chemicals Bureau (2007) recalculated the probability of HC proteinuria because the reference population and the study population were not matched for age (40 versus 53 years, respectively). They estimated that the probability of HC proteinuria (13%) would be twice as high as the reference population at a urinary cadmium concentration of 0.5 μ g/g creatinine. For the second approach, eight published benchmark dose analyses were evaluated (Jin et al. 2004b; Kobayashi et al. 2006, 2008a; Shimizu et al. 2006; Suwazono et al. 2006, 2011b, 2011c; Uno et al. 2005). The lower 95% confidence interval of the benchmark dose (BMDL) for low molecular weight proteinuria

APPENDIX A

ranged from 0.7 µg/g creatinine (Uno et al. 2005) to 9.9 µg/g creatinine (Kobayashi et al. 2006). The third approach involved a meta-analysis of selected environmental exposure dose-response studies. Using individual dose-response functions from each study, estimates of the internal cadmium dose corresponding to probabilities of 10% excess risk of low molecular weight proteinuria were calculated. The lowest UCD₁₀ (1.34 µg/g creatinine) was estimated from the European database; and the 95% lower confidence limit on this UCD₁₀ (UCDL₁₀) of 0.5 µg/g creatinine was considered as a potential point of departure for the MRL.

The points of departure selected using the three different approaches are similar: 0.5 µg/g creatinine from the Järup et al. (2000) study (using the European Chemicals Bureau 2007 recalculation), 0.7 µg/g creatinine from the Uno et al. (2005) benchmark dose analysis, and 0.5 µg/g creatinine from the dose-response analysis. The third approach was selected for the derivation of the MRL because it uses the whole dose-response curves from several studies rather than data from a single study.

Agency Contact (Chemical Manager): Obaid Faroon, DVM, Ph.D.

APPENDIX B. USER'S GUIDE

Chapter 1

Public Health Statement

This chapter of the profile is a health effects summary written in non-technical language. Its intended audience is the general public, especially people living in the vicinity of a hazardous waste site or chemical release. If the Public Health Statement were removed from the rest of the document, it would still communicate to the lay public essential information about the chemical.

The major headings in the Public Health Statement are useful to find specific topics of concern. The topics are written in a question and answer format. The answer to each question includes a sentence that will direct the reader to chapters in the profile that will provide more information on the given topic.

Chapter 2

Relevance to Public Health

This chapter provides a health effects summary based on evaluations of existing toxicologic, epidemiologic, and toxicokinetic information. This summary is designed to present interpretive, weight-of-evidence discussions for human health end points by addressing the following questions:

1. What effects are known to occur in humans?
2. What effects observed in animals are likely to be of concern to humans?
3. What exposure conditions are likely to be of concern to humans, especially around hazardous waste sites?

The chapter covers end points in the same order that they appear within the Discussion of Health Effects by Route of Exposure section, by route (inhalation, oral, and dermal) and within route by effect. Human data are presented first, then animal data. Both are organized by duration (acute, intermediate, chronic). *In vitro* data and data from parenteral routes (intramuscular, intravenous, subcutaneous, etc.) are also considered in this chapter.

The carcinogenic potential of the profiled substance is qualitatively evaluated, when appropriate, using existing toxicokinetic, genotoxic, and carcinogenic data. ATSDR does not currently assess cancer potency or perform cancer risk assessments. Minimal Risk Levels (MRLs) for noncancer end points (if derived) and the end points from which they were derived are indicated and discussed.

Limitations to existing scientific literature that prevent a satisfactory evaluation of the relevance to public health are identified in the Chapter 3 Data Needs section.

Interpretation of Minimal Risk Levels

Where sufficient toxicologic information is available, ATSDR has derived MRLs for inhalation and oral routes of entry at each duration of exposure (acute, intermediate, and chronic). These MRLs are not meant to support regulatory action, but to acquaint health professionals with exposure levels at which adverse health effects are not expected to occur in humans.

APPENDIX B

MRLs should help physicians and public health officials determine the safety of a community living near a chemical emission, given the concentration of a contaminant in air or the estimated daily dose in water. MRLs are based largely on toxicological studies in animals and on reports of human occupational exposure.

MRL users should be familiar with the toxicologic information on which the number is based. Chapter 2, "Relevance to Public Health," contains basic information known about the substance. Other sections such as Chapter 3 Section 3.9, "Interactions with Other Substances," and Section 3.10, "Populations that are Unusually Susceptible" provide important supplemental information.

MRL users should also understand the MRL derivation methodology. MRLs are derived using a modified version of the risk assessment methodology that the Environmental Protection Agency (EPA) provides (Barnes and Dourson 1988) to determine reference doses (RfDs) for lifetime exposure.

To derive an MRL, ATSDR generally selects the most sensitive end point which, in its best judgement, represents the most sensitive human health effect for a given exposure route and duration. ATSDR cannot make this judgement or derive an MRL unless information (quantitative or qualitative) is available for all potential systemic, neurological, and developmental effects. If this information and reliable quantitative data on the chosen end point are available, ATSDR derives an MRL using the most sensitive species (when information from multiple species is available) with the highest no-observed-adverse-effect level (NOAEL) that does not exceed any adverse effect levels. When a NOAEL is not available, a lowest-observed-adverse-effect level (LOAEL) can be used to derive an MRL, and an uncertainty factor (UF) of 10 must be employed. Additional uncertainty factors of 10 must be used both for human variability to protect sensitive subpopulations (people who are most susceptible to the health effects caused by the substance) and for interspecies variability (extrapolation from animals to humans). In deriving an MRL, these individual uncertainty factors are multiplied together. The product is then divided into the inhalation concentration or oral dosage selected from the study. Uncertainty factors used in developing a substance-specific MRL are provided in the footnotes of the levels of significant exposure (LSE) tables.

Chapter 3

Health Effects

Tables and Figures for Levels of Significant Exposure (LSE)

Tables and figures are used to summarize health effects and illustrate graphically levels of exposure associated with those effects. These levels cover health effects observed at increasing dose concentrations and durations, differences in response by species, MRLs to humans for noncancer end points, and EPA's estimated range associated with an upper-bound individual lifetime cancer risk of 1 in 10,000 to 1 in 10,000,000. Use the LSE tables and figures for a quick review of the health effects and to locate data for a specific exposure scenario. The LSE tables and figures should always be used in conjunction with the text. All entries in these tables and figures represent studies that provide reliable, quantitative estimates of NOAELs, LOAELs, or Cancer Effect Levels (CELs).

The legends presented below demonstrate the application of these tables and figures. Representative examples of LSE Table 3-1 and Figure 3-1 are shown. The numbers in the left column of the legends correspond to the numbers in the example table and figure.

APPENDIX B

LEGEND**See Sample LSE Table 3-1 (page B-6)**

- (1) Route of Exposure. One of the first considerations when reviewing the toxicity of a substance using these tables and figures should be the relevant and appropriate route of exposure. Typically when sufficient data exist, three LSE tables and two LSE figures are presented in the document. The three LSE tables present data on the three principal routes of exposure, i.e., inhalation, oral, and dermal (LSE Tables 3-1, 3-2, and 3-3, respectively). LSE figures are limited to the inhalation (LSE Figure 3-1) and oral (LSE Figure 3-2) routes. Not all substances will have data on each route of exposure and will not, therefore, have all five of the tables and figures.
- (2) Exposure Period. Three exposure periods—acute (less than 15 days), intermediate (15–364 days), and chronic (365 days or more)—are presented within each relevant route of exposure. In this example, an inhalation study of intermediate exposure duration is reported. For quick reference to health effects occurring from a known length of exposure, locate the applicable exposure period within the LSE table and figure.
- (3) Health Effect. The major categories of health effects included in LSE tables and figures are death, systemic, immunological, neurological, developmental, reproductive, and cancer. NOAELs and LOAELs can be reported in the tables and figures for all effects but cancer. Systemic effects are further defined in the "System" column of the LSE table (see key number 18).
- (4) Key to Figure. Each key number in the LSE table links study information to one or more data points using the same key number in the corresponding LSE figure. In this example, the study represented by key number 18 has been used to derive a NOAEL and a Less Serious LOAEL (also see the two "18r" data points in sample Figure 3-1).
- (5) Species. The test species, whether animal or human, are identified in this column. Chapter 2, "Relevance to Public Health," covers the relevance of animal data to human toxicity and Section 3.4, "Toxicokinetics," contains any available information on comparative toxicokinetics. Although NOAELs and LOAELs are species specific, the levels are extrapolated to equivalent human doses to derive an MRL.
- (6) Exposure Frequency/Duration. The duration of the study and the weekly and daily exposure regimens are provided in this column. This permits comparison of NOAELs and LOAELs from different studies. In this case (key number 18), rats were exposed to "Chemical x" via inhalation for 6 hours/day, 5 days/week, for 13 weeks. For a more complete review of the dosing regimen, refer to the appropriate sections of the text or the original reference paper (i.e., Nitschke et al. 1981).
- (7) System. This column further defines the systemic effects. These systems include respiratory, cardiovascular, gastrointestinal, hematological, musculoskeletal, hepatic, renal, and dermal/ocular. "Other" refers to any systemic effect (e.g., a decrease in body weight) not covered in these systems. In the example of key number 18, one systemic effect (respiratory) was investigated.
- (8) NOAEL. A NOAEL is the highest exposure level at which no harmful effects were seen in the organ system studied. Key number 18 reports a NOAEL of 3 ppm for the respiratory system, which was used to derive an intermediate exposure, inhalation MRL of 0.005 ppm (see footnote "b").

APPENDIX B

- (9) LOAEL. A LOAEL is the lowest dose used in the study that caused a harmful health effect. LOAELs have been classified into "Less Serious" and "Serious" effects. These distinctions help readers identify the levels of exposure at which adverse health effects first appear and the gradation of effects with increasing dose. A brief description of the specific end point used to quantify the adverse effect accompanies the LOAEL. The respiratory effect reported in key number 18 (hyperplasia) is a Less Serious LOAEL of 10 ppm. MRLs are not derived from Serious LOAELs.
- (10) Reference. The complete reference citation is given in Chapter 9 of the profile.
- (11) CEL. A CEL is the lowest exposure level associated with the onset of carcinogenesis in experimental or epidemiologic studies. CELs are always considered serious effects. The LSE tables and figures do not contain NOAELs for cancer, but the text may report doses not causing measurable cancer increases.
- (12) Footnotes. Explanations of abbreviations or reference notes for data in the LSE tables are found in the footnotes. Footnote "b" indicates that the NOAEL of 3 ppm in key number 18 was used to derive an MRL of 0.005 ppm.

LEGEND**See Sample Figure 3-1 (page B-7)**

LSE figures graphically illustrate the data presented in the corresponding LSE tables. Figures help the reader quickly compare health effects according to exposure concentrations for particular exposure periods.

- (13) Exposure Period. The same exposure periods appear as in the LSE table. In this example, health effects observed within the acute and intermediate exposure periods are illustrated.
- (14) Health Effect. These are the categories of health effects for which reliable quantitative data exists. The same health effects appear in the LSE table.
- (15) Levels of Exposure. Concentrations or doses for each health effect in the LSE tables are graphically displayed in the LSE figures. Exposure concentration or dose is measured on the log scale "y" axis. Inhalation exposure is reported in mg/m³ or ppm and oral exposure is reported in mg/kg/day.
- (16) NOAEL. In this example, the open circle designated 18r identifies a NOAEL critical end point in the rat upon which an intermediate inhalation exposure MRL is based. The key number 18 corresponds to the entry in the LSE table. The dashed descending arrow indicates the extrapolation from the exposure level of 3 ppm (see entry 18 in the table) to the MRL of 0.005 ppm (see footnote "b" in the LSE table).
- (17) CEL. Key number 38m is one of three studies for which CELs were derived. The diamond symbol refers to a CEL for the test species-mouse. The number 38 corresponds to the entry in the LSE table.

APPENDIX B

- (18) Estimated Upper-Bound Human Cancer Risk Levels. This is the range associated with the upper-bound for lifetime cancer risk of 1 in 10,000 to 1 in 10,000,000. These risk levels are derived from the EPA's Human Health Assessment Group's upper-bound estimates of the slope of the cancer dose response curve at low dose levels (q_1^*).
- (19) Key to LSE Figure. The Key explains the abbreviations and symbols used in the figure.

SAMPLE

1 →

Table 3-1. Levels of Significant Exposure to [Chemical x] – Inhalation

	Key to figure ^a	Species	Exposure frequency/ duration	System	NOAEL (ppm)	LOAEL (effect)		Reference
						Less serious (ppm)	Serious (ppm)	
2 →	INTERMEDIATE EXPOSURE							
		5	6	7	8	9		10
3 →	Systemic	↓	↓	↓	↓	↓		↓
4 →	18	Rat	13 wk 5 d/wk 6 hr/d	Resp	3 ^b	10 (hyperplasia)		Nitschke et al. 1981
	CHRONIC EXPOSURE							
	Cancer						11	
							↓	
	38	Rat	18 mo 5 d/wk 7 hr/d			20	(CEL, multiple organs)	Wong et al. 1982
	39	Rat	89–104 wk 5 d/wk 6 hr/d			10	(CEL, lung tumors, nasal tumors)	NTP 1982
	40	Mouse	79–103 wk 5 d/wk 6 hr/d			10	(CEL, lung tumors, hemangiosarcomas)	NTP 1982

12 →

^a The number corresponds to entries in Figure 3-1.

^b Used to derive an intermediate inhalation Minimal Risk Level (MRL) of 5×10^{-3} ppm; dose adjusted for intermittent exposure and divided by an uncertainty factor of 100 (10 for extrapolation from animal to humans, 10 for human variability).

SAMPLE

Figure 3-1. Levels of Significant Exposure to [Chemical X] - Inhalation

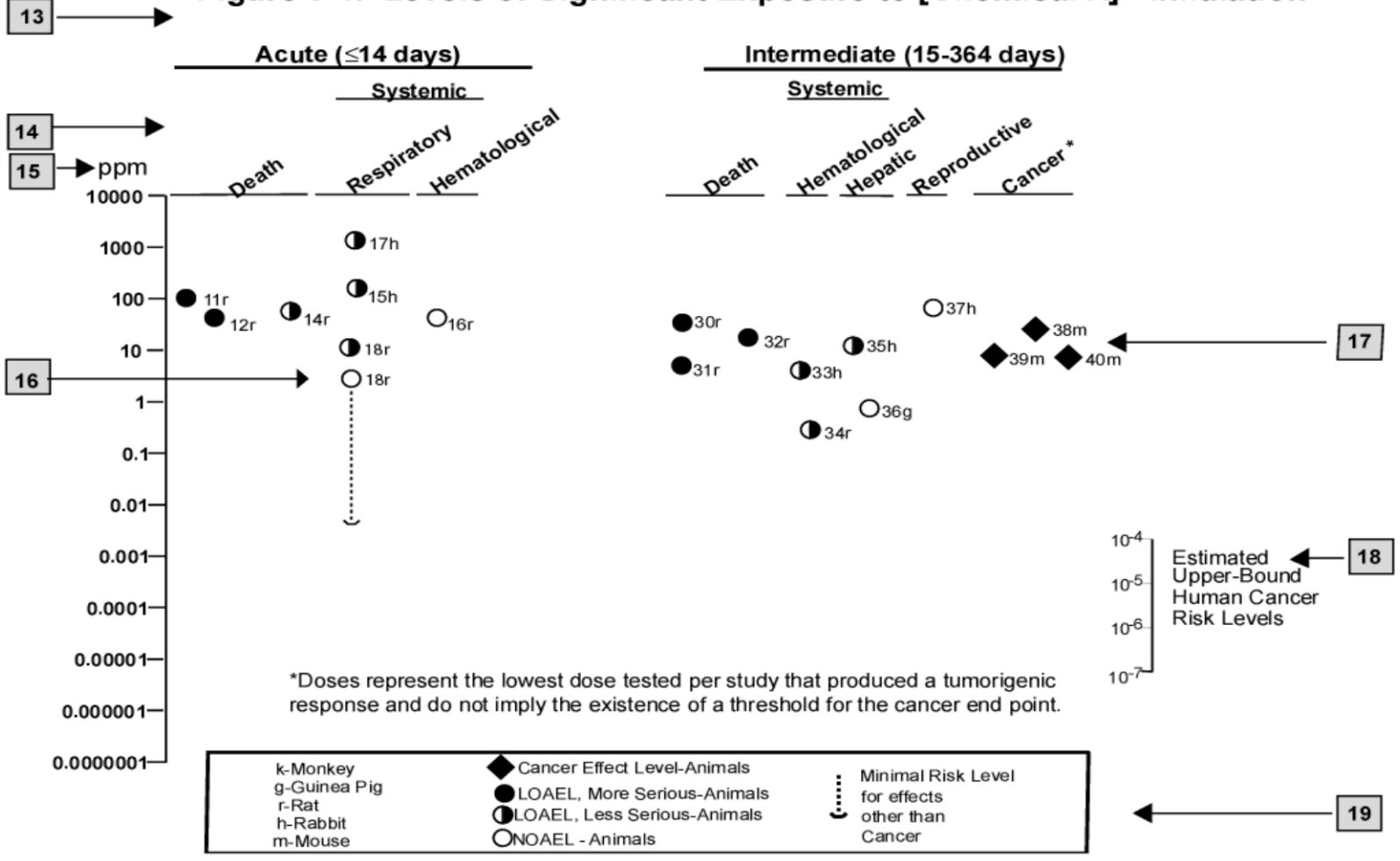

APPENDIX B

This page is intentionally blank.

APPENDIX C. ACRONYMS, ABBREVIATIONS, AND SYMBOLS

ACGIH	American Conference of Governmental Industrial Hygienists
ACOEM	American College of Occupational and Environmental Medicine
ADI	acceptable daily intake
ADME	absorption, distribution, metabolism, and excretion
AED	atomic emission detection
AFID	alkali flame ionization detector
AFOSH	Air Force Office of Safety and Health
ALT	alanine aminotransferase
AML	acute myeloid leukemia
AOAC	Association of Official Analytical Chemists
AOEC	Association of Occupational and Environmental Clinics
AP	alkaline phosphatase
APHA	American Public Health Association
AST	aspartate aminotransferase
atm	atmosphere
ATSDR	Agency for Toxic Substances and Disease Registry
AWQC	Ambient Water Quality Criteria
BAT	best available technology
BCF	bioconcentration factor
BEI	Biological Exposure Index
BMD/C	benchmark dose or benchmark concentration
BMD _x	dose that produces a X% change in response rate of an adverse effect
BMDL _x	95% lower confidence limit on the BMD _x
BMDS	Benchmark Dose Software
BMR	benchmark response
BSC	Board of Scientific Counselors
C	centigrade
CAA	Clean Air Act
CAG	Cancer Assessment Group of the U.S. Environmental Protection Agency
CAS	Chemical Abstract Services
CDC	Centers for Disease Control and Prevention
CEL	cancer effect level
CELDS	Computer-Environmental Legislative Data System
CERCLA	Comprehensive Environmental Response, Compensation, and Liability Act
CFR	Code of Federal Regulations
Ci	curie
CI	confidence interval
CL	ceiling limit value
CLP	Contract Laboratory Program
cm	centimeter
CML	chronic myeloid leukemia
CPSC	Consumer Products Safety Commission
CWA	Clean Water Act
DHEW	Department of Health, Education, and Welfare
DHHS	Department of Health and Human Services
DNA	deoxyribonucleic acid
DOD	Department of Defense
DOE	Department of Energy
DOL	Department of Labor

APPENDIX C

DOT	Department of Transportation
DOT/UN/ NA/IMDG	Department of Transportation/United Nations/ North America/Intergovernmental Maritime Dangerous Goods Code
DWEL	drinking water exposure level
ECD	electron capture detection
ECG/EKG	electrocardiogram
EEG	electroencephalogram
EEGL	Emergency Exposure Guidance Level
EPA	Environmental Protection Agency
F	Fahrenheit
F ₁	first-filial generation
FAO	Food and Agricultural Organization of the United Nations
FDA	Food and Drug Administration
FEMA	Federal Emergency Management Agency
FIFRA	Federal Insecticide, Fungicide, and Rodenticide Act
FPD	flame photometric detection
fpm	feet per minute
FR	Federal Register
FSH	follicle stimulating hormone
g	gram
GC	gas chromatography
gd	gestational day
GLC	gas liquid chromatography
GPC	gel permeation chromatography
HPLC	high-performance liquid chromatography
HRGC	high resolution gas chromatography
HSDB	Hazardous Substance Data Bank
IARC	International Agency for Research on Cancer
IDLH	immediately dangerous to life and health
ILO	International Labor Organization
IRIS	Integrated Risk Information System
K _d	adsorption ratio
kg	kilogram
kkg	metric ton
K _{oc}	organic carbon partition coefficient
K _{ow}	octanol-water partition coefficient
L	liter
LC	liquid chromatography
LC ₅₀	lethal concentration, 50% kill
LC _{Lo}	lethal concentration, low
LD ₅₀	lethal dose, 50% kill
LD _{Lo}	lethal dose, low
LDH	lactic dehydrogenase
LH	lutinizing hormone
LOAEL	lowest-observed-adverse-effect level
LSE	Levels of Significant Exposure
LT ₅₀	lethal time, 50% kill
m	meter
MA	<i>trans,trans</i> -muconic acid
MAL	maximum allowable level
mCi	millicurie

APPENDIX C

MCL	maximum contaminant level
MCLG	maximum contaminant level goal
MF	modifying factor
MFO	mixed function oxidase
mg	milligram
mL	milliliter
mm	millimeter
mmHg	millimeters of mercury
mmol	millimole
mppcf	millions of particles per cubic foot
MRL	Minimal Risk Level
MS	mass spectrometry
NAAQS	National Ambient Air Quality Standard
NAS	National Academy of Science
NATICH	National Air Toxics Information Clearinghouse
NATO	North Atlantic Treaty Organization
NCE	normochromatic erythrocytes
NCEH	National Center for Environmental Health
NCI	National Cancer Institute
ND	not detected
NFPA	National Fire Protection Association
ng	nanogram
NHANES	National Health and Nutrition Examination Survey
NIEHS	National Institute of Environmental Health Sciences
NIOSH	National Institute for Occupational Safety and Health
NIOSHTIC	NIOSH's Computerized Information Retrieval System
NLM	National Library of Medicine
nm	nanometer
nmol	nanomole
NOAEL	no-observed-adverse-effect level
NOES	National Occupational Exposure Survey
NOHS	National Occupational Hazard Survey
NPD	nitrogen phosphorus detection
NPDES	National Pollutant Discharge Elimination System
NPL	National Priorities List
NR	not reported
NRC	National Research Council
NS	not specified
NSPS	New Source Performance Standards
NTIS	National Technical Information Service
NTP	National Toxicology Program
ODW	Office of Drinking Water, EPA
OERR	Office of Emergency and Remedial Response, EPA
OHM/TADS	Oil and Hazardous Materials/Technical Assistance Data System
OPP	Office of Pesticide Programs, EPA
OPPT	Office of Pollution Prevention and Toxics, EPA
OPPTS	Office of Prevention, Pesticides and Toxic Substances, EPA
OR	odds ratio
OSHA	Occupational Safety and Health Administration
OSW	Office of Solid Waste, EPA
OTS	Office of Toxic Substances

APPENDIX C

OW	Office of Water
OWRS	Office of Water Regulations and Standards, EPA
PAH	polycyclic aromatic hydrocarbon
PBPD	physiologically based pharmacodynamic
PBPK	physiologically based pharmacokinetic
PCE	polychromatic erythrocytes
PEL	permissible exposure limit
pg	picogram
PHS	Public Health Service
PID	photo ionization detector
pmol	picomole
PMR	proportionate mortality ratio
ppb	parts per billion
ppm	parts per million
ppt	parts per trillion
PSNS	pretreatment standards for new sources
RBC	red blood cell
REL	recommended exposure level/limit
RfC	reference concentration
RfD	reference dose
RNA	ribonucleic acid
RQ	reportable quantity
RTECS	Registry of Toxic Effects of Chemical Substances
SARA	Superfund Amendments and Reauthorization Act
SCE	sister chromatid exchange
SGOT	serum glutamic oxaloacetic transaminase
SGPT	serum glutamic pyruvic transaminase
SIC	standard industrial classification
SIM	selected ion monitoring
SMCL	secondary maximum contaminant level
SMR	standardized mortality ratio
SNARL	suggested no adverse response level
SPEGL	Short-Term Public Emergency Guidance Level
STEL	short term exposure limit
STORET	Storage and Retrieval
TD ₅₀	toxic dose, 50% specific toxic effect
TLV	threshold limit value
TOC	total organic carbon
TPQ	threshold planning quantity
TRI	Toxics Release Inventory
TSCA	Toxic Substances Control Act
TWA	time-weighted average
UF	uncertainty factor
U.S.	United States
USDA	United States Department of Agriculture
USGS	United States Geological Survey
VOC	volatile organic compound
WBC	white blood cell
WHO	World Health Organization

APPENDIX C

>	greater than
≥	greater than or equal to
=	equal to
<	less than
≤	less than or equal to
%	percent
α	alpha
β	beta
γ	gamma
δ	delta
μm	micrometer
μg	microgram
q ₁ *	cancer slope factor
-	negative
+	positive
(+)	weakly positive result
(-)	weakly negative result

APPENDIX C

This page is intentionally blank.

APPENDIX D. INDEX

absorbed dose.....	231, 233
adenocarcinoma.....	103
adenocarcinomas.....	103, 104, 181
adrenal gland.....	167
adrenals.....	167
adsorbed.....	280, 291
adsorption.....	274, 291, 292, 293, 330
aerobic.....	275
alanine aminotransferase (see ALT).....	85, 145
ALT (see alanine aminotransferase).....	146
ambient air.....	11, 280, 296, 305, 315, 317, 321, 326
anemia.....	25, 26, 27, 84, 138, 139, 240, 249
aspartate aminotransferase (see AST).....	145
AST (see aspartate aminotransferase).....	146
bioaccumulation.....	326
bioavailability.....	292, 293, 301, 303, 323, 325, 329, 330, 343
bioconcentration factor.....	293
biokinetic.....	232, 345
biological half-time.....	202
biomarker.....	13, 16, 21, 31, 32, 33, 35, 36, 37, 39, 86, 88, 89, 90, 136, 141, 143, 145, 147, 148, 149, 150, 151, 152, 153, 154, 155, 156, 157, 158, 160, 161, 164, 165, 170, 230, 231, 232, 234, 235, 237, 240, 250, 254, 255, 258, 333
blood cell count.....	84
body weight effects.....	93, 168
breast milk.....	6, 228, 259, 319, 326
cancer.....	5, 15, 46, 100, 101, 102, 104, 177, 178, 179, 226, 238, 246, 251, 256, 350
carcinogen.....	5, 13, 15, 100, 102, 104, 251, 256, 350
carcinogenic.....	5, 15, 45, 46, 101, 102, 103, 104, 178, 180, 223, 251, 256, 350
carcinogenicity.....	100, 102, 104, 251, 350
carcinoma.....	73, 103, 104, 179, 181, 224
cardiovascular.....	82, 83, 136, 181
cardiovascular effects.....	82, 136
chromosomal aberrations.....	184, 187, 252
clearance.....	22, 26, 47, 49, 154, 166, 192, 198, 200, 206, 218, 229, 235, 249, 256
crustaceans.....	301
death.....	4, 5, 45, 46, 47, 48, 49, 81, 89, 105, 136, 147, 177, 181, 234, 250
deoxyribonucleic acid (see DNA).....	186, 190
dermal effects.....	93, 167, 182
developmental effects.....	14, 19, 25, 27, 99, 174, 177, 184, 248, 253, 256, 257
DNA (see deoxyribonucleic acid).....	81, 176, 184, 185, 186, 187, 188, 189, 190, 220, 231, 245, 252, 259
elimination half-time.....	16
endocrine.....	97, 167, 224, 225
endocrine effects.....	167
fetus.....	225, 258
follicle stimulating hormone.....	170
fractional absorption.....	105, 195
gastrointestinal effects.....	83, 139
general population.....	13, 16, 20, 30, 47, 143, 169, 178, 184, 232, 240, 254, 305, 323, 326
genotoxic.....	45, 184, 187

APPENDIX D

genotoxicity.....	191, 246, 251
groundwater.....	11, 280, 288, 298, 349
half-life.....	210, 215, 221, 231
hematological effects.....	13, 84, 139
hematopoietic.....	174, 251
hepatic effects.....	13, 85, 145, 146, 147, 237
hydrolysis.....	146
immune system.....	169, 182, 228
immunological.....	13, 26, 45, 94, 95, 169, 182, 254
immunological effects.....	13, 94, 95, 169, 182
K_{ow}	264, 265, 266
LD_{50}	105, 181
leukemia.....	27, 106, 169, 180
menstrual.....	98
metabolic effects.....	169
micronuclei.....	184, 187, 191
milk.....	200, 228, 234, 242, 255, 297, 300, 319, 336, 338
mucociliary.....	23, 47, 49, 198, 200, 206, 217, 219, 229
musculoskeletal effects.....	84, 85, 140
neonatal.....	322, 327, 338
neurobehavioral.....	14, 19, 99, 100, 175, 225, 227, 253, 254
neurodevelopmental.....	19, 27, 249, 257
neurological effects.....	95, 96, 169, 170, 184, 227, 237
nuclear.....	169
ocular effects.....	93, 167, 182
odds ratio.....	137, 143, 156, 157, 158, 171, 178
partition coefficients.....	197
pharmacodynamic.....	203
pharmacokinetic.....	16, 22, 23, 43, 81, 203, 204, 205, 225, 345
photolysis.....	103
placenta.....	199, 200, 229, 230, 234, 258, 322, 327
pulmonary fibrosis.....	50
rate constant.....	211, 214, 216
renal effects.....	22, 31, 32, 85, 87, 147, 149, 160, 166, 181, 237, 250, 255
reproductive effects.....	97, 98, 99, 170, 172, 174, 184, 249, 252, 350
respiratory effects.....	17, 21, 50, 73, 77, 79, 93, 106, 234, 248, 250, 345
retention.....	22, 48, 49, 50, 192, 193, 197, 202, 211, 213, 218, 219, 228, 292
salivation.....	139
sequestered.....	220
solubility.....	12, 22, 45, 49, 50, 192, 218, 256, 275, 294
spermatozoa.....	170, 186
systemic effects.....	50, 94, 106, 181, 256
T3.....	51, 107, 183
thyroid.....	155, 167
thyroid stimulating hormone.....	167
toxicokinetic.....	12, 16, 45, 202, 204, 219, 230, 250, 255, 256, 258
tremors.....	17, 96
tumors.....	103, 104, 174, 179, 180, 181, 251, 256
vapor pressure.....	290
volatility.....	192

